

W-CDMA Guide with HSDPA/HSUPA

Agilent Technologies PSA Series and VSA E4406A

Options BAF, 210

This manual provides documentation for the following instruments:

Transmitter Tester:

E4406A

Spectrum Analyzers:

E4440A (3 Hz - 26.5 GHz)

E4443A (3 Hz - 6.7 GHz)

E4445A (3 Hz - 13.2 GHz)

E4446A (3 Hz - 44.0 GHz)

E4447A (3 Hz - 42.98 GHz)

E4448A (3 Hz - 50.0 GHz)



Agilent Technologies

Manufacturing Part Number: E4406-90279

Supersedes E4406-90274

Printed in Malaysia

April 2006

© Copyright 1999 - 2006 Agilent Technologies, Inc.

The information contained in this document is subject to change without notice.

Agilent Technologies makes no warranty of any kind with regard to this material, including but not limited to, the implied warranties of merchantability and fitness for a particular purpose. Agilent Technologies shall not be liable for errors contained herein or for incidental or consequential damages in connection with the furnishing, performance, or use of this material.

1. Introduction

What Do the Agilent PSA Series and VSA E4406A Options BAF and 210 Do?	54
Installing Optional Measurement Personalities	56
Do You Have Enough Memory to Load All Your Personality Options?	56
How to Predict Your Memory Requirements	58
Loading an Optional Measurement Personality	61
Obtaining and Installing a License Key	61
Viewing a License Key	63
Using the Delete License Key on PSA	63
Using the Uninstall Key on E4406A	64
Ordering Optional Measurement Personalities	65

2. Making Measurements

W-CDMA (3GPP) Measurements	68
Setting up and Making a Measurement	69
Making the Initial Signal Connection	69
Using Instrument Mode and Measurement Presets	69
The 3 Steps to Set Up and Make Measurements	70
ACPR (ACLR) Measurements	71
Configuring the Measurement System	71
Setting the MS (Example)	72
Measurement Procedure	72
Channel Power Measurements	76
Configuring the Measurement System	76
Setting the MS (Example)	77
Measurement Procedure	77
Code Domain Measurements	79
Configuring the Measurement System	79
W-CDMA UL Measurement Example (Normal Mode)	80
HSDPA DL Measurement Example (Test Model 5)	86
Troubleshooting Hints	93
Intermodulation Measurements	94
Configuring the Measurement System	94
Setting the BTS and Signal Generator	95
Measurement Procedure	96
Troubleshooting Hints	97
Modulation Accuracy (Composite EVM) Measurements	98
Configuring the Measurement System	98
Setting the MS	99
Measurement Procedure	99
Troubleshooting Hints	102
Multi Carrier Power Measurements	103
Configuring the Measurement System	103
Setting the BTS and W-CDMA Signal Generator	104
Measurement Procedure	104
Troubleshooting Hints	106
Occupied Bandwidth Measurements	107
Configuring the Measurement System	107

Contents

Setting the MS	108
Measurement Procedure	108
Troubleshooting Hints	109
Power Control Measurements	110
Configuring the Measurement System	110
Setting the MS	111
Measurement Procedure	111
Troubleshooting Hints	113
Power Statistics CCDF Measurements	114
Configuring the Measurement System	114
Setting the MS	115
Measurement Procedure	115
Troubleshooting Hints	116
Power versus Time (PvT) Mask Measurements	117
Configuring the Measurement System	117
Setting the MS	118
Measurement Procedure	118
Troubleshooting Hints	119
QPSK EVM Measurements	120
Configuring the Measurement System	120
Setting the MS	121
Measurement Procedure	121
Troubleshooting Hints	124
Spectrum (Frequency Domain) Measurements	125
Configuring the Measurement System	125
Setting the BTS	126
Measurement Procedure	126
Spectrum Emission Mask Measurements	145
Configuring the Measurement System	145
Setting the MS	146
Measurement Procedure	146
Troubleshooting Hints	148
Waveform (Time Domain) Measurements	149
Configuring the Measurement System	149
Setting the BTS	150
Measurement Procedure	150
Using Option B7C Baseband I/Q Inputs	169
Baseband I/Q Measurements Available for E4406A VSA Series Transmitter Tester	169
Baseband I/Q Measurement Overview	170
Baseband I/Q Measurement Result Examples	171
Using Basic Mode	182
Basic Mode in E4406A VSA Series Transmitter Testers	182
Basic Mode in PSA Series Spectrum Analyzers	182
Interpreting Common Error Codes	183
3. Key Reference	
Instrument Front Panel Highlights	186
Selected E4406A VSA and PSA Front-Panel Features	188
Front Panel Keys	190

FREQUENCY Channel Key Menu	190
MEASURE Key Menu	191
Meas Control Key Menu	194
Mode Setup Key Menu	195
Input/Output Key Menu	204
W-CDMA Measurement Keys	211
Adjacent Channel Power Ratio (ACPR/ACLR) Keys	211
Channel Power Keys	229
Code Domain Keys	233
Intermod Keys	256
Mod Accuracy (Composite EVM) Keys	260
Multi Carrier Power Keys	279
Occupied BW Keys	283
Power Stat CCDF Keys	286
Pwr Control Keys	289
Power versus Time (PvT) Mask Keys	299
QPSK EVM Keys	308
Spectrum Emission Mask Keys	315
Spectrum (Frequency Domain) Keys	327
Waveform (Time Domain) Keys	358
Baseband I/Q Inputs (Option B7C) Keys	384
Input Port Key Menu	384
I/Q Setup Key Menu	385
I/Q Range Key Menu	391
Baseband I/Q Key Access Locations	392

4. Concepts

What Is the W-CDMA Communications System?	396
W-CDMA Code Division Multiple Access	397
Base Station and User Equipment Identification	399
Data Channelization	400
W-CDMA Slots, Frames, and Power Control	402
Protocol Structure	403
Logical Transport and Physical Channels	404
Downlink Physical Channels	406
Uplink Physical Channels	408
Transport Format Detection	410
Downlink DPDCH/DPCCH Coding and Air Interface	411
Uplink DPDCH/DPCCH Coding and Air Interface	413
Reference measurement channels	415
Compressed Mode	416
Asynchronous Cell site Acquisition	417
Asynchronous Cell Site Soft Handover	418
HSDPA Concepts	419
What is HSDPA?	419
Protocol Structure	419
HSDPA Logical, Transport, and Physical Channels	420
Downlink Physical Channels	421
Uplink Physical Channel	426

Contents

HSDPA Physical Channel Timing	429
Transport Format Detection	430
HSDPA Measurement Concepts	431
HSUPA Concepts	446
What is HSUPA?	446
Protocol Structure	446
HSUPA Logical, Transport, and Physical Channels	447
HSUPA Downlink E-CDH Physical Channels	447
HSUPA Uplink Physical Channels	449
Adjacent Channel Power Ratio (ACPR/ACLR) Measurement Concepts	455
Purpose	455
What Is Adjacent Channel Interference?	455
Measurement Method	456
Channel Power Measurement Concepts	458
Purpose	458
Measurement Method	458
Code Domain Measurement Concepts	459
Purpose	459
Measurement Method	472
Intermodulation Measurement Concepts	475
Purpose	475
Measurement Method	475
Modulation Accuracy - (Composite EVM)	476
Purpose	476
Measurement Method	480
Multi Carrier Power Measurement Concepts	482
Purpose	482
Measurement Method	482
Occupied Bandwidth Measurement Concepts	484
Purpose	484
Measurement Method	484
Power Control Measurement Concepts	485
Purpose	485
PRACH Measurements	486
Measurement Method	487
Power Stat CCDF Measurement Concepts	488
Purpose	488
Measurement Method	490
Power versus Time Mask Measurement Concepts	491
Purpose	491
Measurement Method	491
QPSK EVM Measurement Concepts	492
Purpose	492
Measurement Method	497
Spectrum Emission Mask Measurement Concepts	498
Purpose	498
Measurement Method	498
Spectrum (Frequency Domain) Measurement Concepts	499
Purpose	499

Measurement Method	499
Troubleshooting Hints	499
Waveform (Time Domain) Measurement Concepts	500
Purpose	500
Measurement Method	500
Baseband I/Q Inputs (Option B7C) Measurement Concepts	501
What are Baseband I/Q Inputs?	501
What are Baseband I/Q Signals?	502
Why Make Measurements at Baseband?	502
Selecting Input Probes for Baseband Measurements	503
Baseband I/Q Measurement Views	506
Other Sources of Measurement Information	509
Instrument Updates at www.agilent.com	509
References	510
5. Menu Maps	
W-CDMA (3GPP) Measurement Key Flow	514
Directions for Use	515
6. Programming Commands	
SCPI Command Subsystems	556
Programming Command Compatibility	
Across Model Numbers and Across Modes	557
Across PSA Modes: Command Subsystem Similarities	557
Across PSA Modes: Specific Command Differences	559
Using Applications in PSA Series vs. VSA E4406A	560
CALCulate Subsystem	562
Code Domain Power - Limits	562
Data Query	580
Calculate/Compress Trace Data Query	580
Calculate Peaks of Trace Data	590
QPSK EVM - Limits	591
CALCulate:MARKers Subsystem	592
Occupied Bandwidth - Limits	604
Power Control Commands	606
Power Statistic CCDF—Store Reference	611
Modulation Accuracy - Limits	611
Marker Commands	618
CONFigure Subsystem	619
Configure the Selected Measurement	619
Configure Query	619
DISPlay Subsystem	620
Adjacent Channel Power - View Selection	620
Code Domain - View Selection	620
Turn the Display On/Off	622
Select Display Format	622
Full Screen Display	623
PCON (Power Control) - W-CDMA	624

Contents

PVT - Limit Mask Display	624
PVT - View Selection	625
Modulation Accuracy (Rho) - View Selection	626
Spectrum - Y-Axis Scale/Div	627
Spectrum - Y-Axis Reference Level	628
Turn a Trace Display On/Off	629
Waveform - Y-Axis Scale/Div	634
Waveform - Y-Axis Reference Level	635
Window Focus Move Control	636
Window Selection	636
X-Scale Commands	637
Y-Scale Commands	640
Y Scale/Div	643
Y Ref Value	644
FETCh Subsystem	645
Fetch the Current Measurement Results	645
FORMat Subsystem	646
Byte Order	646
Numeric Data Format	646
INITiate Subsystem	648
Take New Data Acquisition for Selected Measurement	648
Continuous or Single Measurements	648
Take New Data Acquisitions	649
Restart the Measurement	649
INSTrument Subsystem	650
Catalog Query	650
Select Application by Number	650
Select Application	652
MEASure Group of Commands	654
Command Interactions: MEASure, CONFIgure, FETCh, INITiate and READ	654
Adjacent Channel Power Ratio (ACP) Measurement	658
50 MHz Amplitude Reference Measurement	666
Code Domain Power Measurement	667
Channel Power Measurement	702
QPSK Error Vector Magnitude Measurement	703
Intermodulation Measurement	706
Multi Carrier Power Measurement	709
Occupied Bandwidth Measurement	711
Power Control Measurement	713
Power Statistics CCDF Measurement	718
Power vs. Time Measurement	720
Modulation Accuracy (Rho) Measurement	724
Spurious Emissions Measurement	746
Spectrum (Frequency Domain) Measurement	752
Timebase Frequency Measurement	754
Waveform (Time Domain) Measurement	755
READ Subsystem	757
Initiate and Read Measurement Data	757
SENSe Subsystem	758

Adjacent Channel Power Measurement	758
Baseband I/Q Commands (E4406A only).	786
Code Domain Measurement	787
Channel Power Measurement	847
Signal Corrections Commands	852
QPSK Error Vector Magnitude Measurement	853
RF Input Signal Alignments	859
Frequency Commands	863
Center Frequency	863
Center Frequency Step Size Automatic	864
Center Frequency Step Size	864
Intermodulation Measurement	865
Intermodulation—Average Count	865
Intermodulation—Averaging State	865
Intermodulation—Averaging Termination Control	866
Intermodulation—Integration Bandwidth	866
Intermodulation—Resolution Bandwidth	867
Intermodulation—Resolution Bandwidth State	867
Intermodulation—Root Raised Cosine Filter Alpha	867
Intermodulation—Root Raised Cosine Filter State	868
Intermodulation—Base Frequency Auto Search	868
Intermodulation—Base Frequencies Delta	869
Intermodulation—Base Lower Frequency	869
Intermodulation—Base Upper Frequency	870
Intermodulation—Span	870
Intermodulation—Measurement Mode	871
Intermodulation—Measurement Reference	871
Multi Carrier Power Measurement	872
Multi Carrier Power—Average Count	872
Multi Carrier Power—Averaging State	872
Multi Carrier Power—Averaging Termination Control	873
Multi Carrier Power—Root Raised Cosine Filter Alpha	873
Multi Carrier Power—Root Raised Cosine Filter State	873
Multi Carrier Power—Base Frequencies Delta	874
Multi Carrier Power—Offset Frequency Absolute Limit	874
Multi Carrier Power—Offset Frequency Relative Limit to Carrier	875
Multi Carrier Power—Offset Frequency Test Mode	876
Multi Carrier Power—Offset Selection	877
Multi Carrier Power—Measurement Reference	877
Occupied Bandwidth Measurement	878
Occupied Bandwidth—Average Count	878
Occupied Bandwidth—Averaging State	879
Occupied Bandwidth—Averaging Termination Control	879
Occupied Bandwidth—Resolution Bandwidth	880
Occupied Bandwidth—FFT Window	880
Occupied Bandwidth—Span	881
Occupied Bandwidth—Trigger Source	881
Power Control Measurement	883
Power Control—ADC Range.	883

Contents

Power Control—Resolution Bandwidth	.885
Power Control—RBW Filter Type	.886
Power Control—Data Capture Length	.887
Power Control—Chip Rate	.888
Power Control—Root Raised Cosine Alpha	.888
Power Control—Root Raised Cosine Filter Control	.889
Power Control—Measurement Data Type	.889
Power Control—PRACH Noise Floor	.890
Power Control—PRACH Preamble Signature	.891
Power Control—PRACH Preamble Signature Detection	.891
Power Control—Symbol Boundary Custom Active Channel List MS [MS only]	.892
Power Control—Symbol Boundary Custom Active Channel List—The Number Of Entries MS [MS only]	.895
Power Control—Symbol Boundary MS [MS only]	.896
Power Control—Slot Format	.897
Power Control—Sync Start Slot	.898
Power Control—Scramble Code Up Link	.899
Power Control—Trigger Source	.900
Power Control - Measurement Type	.901
Select I/Q Power Range (E4406A only)	.902
Select I/Q Voltage Range (E4406A only)	.903
RF Power Commands	.904
RF Port Input Attenuation	.904
Internal RF Preamplifier Control	.904
Internal RF Preamplifier Attenuation	.905
RF Port Power Range Auto	.906
RF Port Power Range Maximum Total Power	.907
Power Statistics CCDF Measurement	.908
Power Statistics CCDF—Channel Bandwidth	.908
Power Statistics CCDF—Sample Counts	.908
Power Statistics CCDF—Sweep Time	.909
Power Statistics CCDF—Trigger Source	.909
Power vs. Time Measurement	.910
Power vs. Time—Average Count	.910
Power vs. Time—Averaging State	.910
Power vs. Time—Averaging Termination Control	.911
Power vs. Time—Averaging Type	.911
Power vs. Time—Resolution BW	.913
Power vs. Time—RBW Filter Type	.914
Power vs. Time—Burst Search Threshold	.915
Power vs. Time—Chip Rate	.915
Power vs. Time—Root Raised Cosine Filter Alpha	.915
Power vs. Time—Root Raised Cosine Filter Control	.916
Power vs. Time—Limit Mask Display	.916
Power vs. Time—Lower Mask Relative Amplitude Levels	.916
Power vs. Time—Mask Lower Limit Test Mode	.917
Power vs. Time—Mask Power Reference	.917
Power vs. Time—Mask Interval	.918
Power vs. Time—Mask Offset	.918

Power vs. Time—Upper Mask Relative Amplitude Levels	918
Power vs. Time—Mask Upper Limit Test Mode	920
Power vs. Time—Mask Reference Point	921
Power vs. Time—Mask Reference Point Offset	921
Power vs. Time—Trigger Source	922
Radio Standards Commands	923
HSDPA/HSUPA Enable	923
Radio Device Under Test	924
Modulation Accuracy (Rho) Measurement	925
Modulation Accuracy (Rho)—ADC Range	925
Modulation Accuracy (Rho)—Demod Alpha	927
Modulation Accuracy (Rho)—Average Count	928
Modulation Accuracy (Rho)—Averaging State	928
Modulation Accuracy (Rho)—Averaging Termination Control	929
Modulation Accuracy (RHO)- Capture Interval	929
Modulation Accuracy (Rho)—Chip Rate	930
Modulation Accuracy (RHO)—Frequency Error Tolerance Range.....	930
Modulation Accuracy (Rho)—Multi Carrier Estimator	931
Modulation Accuracy (Rho)—MICH Code Number [BTS only]	932
Modulation Accuracy (RHO)—Timing Estimation	933
Modulation Accuracy (RHO)—PICH Code Number	934
Modulation Accuracy (Rho)—PRACH Preamble Signature	935
Modulation Accuracy (Rho)—Symbol Boundary Custom Active Channel List MS	935
Modulation Accuracy (Rho)—Symbol Boundary Custom Active Channel List – The Number Of Entries MS [MS only]	940
Modulation Accuracy (Rho)—Symbol Boundary Custom Active Channel List – Load Preset Setting BTS [BTS only]	941
Modulation Accuracy (Rho)—Symbol Boundary Custom Active Channel List BTS	943
Modulation Accuracy (Rho)—Symbol Boundary Custom Active — The Number of Entries BTS [BTS only]	946
Modulation Accuracy (Rho)—Symbol Boundary Custom Active — Load Preset Setting BTS [BTS only]	947
Modulation Accuracy (Rho)—Symbol Boundary Custom Active — The Number of Entries BTS [BTS only]	948
Modulation Accuracy (Rho)—Symbol Boundary MS [MS only]	948
Modulation Accuracy (Rho)—Symbol Boundary MS Init [MS only]	949
Modulation Accuracy (Rho)—Symbol Boundary MS Replace [MS only]	952
Modulation Accuracy (Rho)—Symbol Boundary MS Query [MS only]	956
Modulation Accuracy (Rho)—Symbol Boundary Custom Active Channel List MS Query [MS Only]	958
Modulation Accuracy (Rho)—Symbol Boundary for BTS	958
Modulation Accuracy (Rho)—PRACH Preamble Signature Detection	964
Modulation Accuracy (Rho)—Slot Format [MS only]	965
Modulation Accuracy (Rho)—Sync Start Slot Number Detection State	967
Modulation Accuracy (Rho)—Spectrum Normal/Invert	968
Modulation Accuracy (Rho)—Transient Period Exclude.....	969
Modulation Accuracy (RHO)—Sync Type (BTS)	969
Modulation Accuracy (Rho)—Sync Type (MS)	970
Modulation Accuracy (Rho)—Scramble Code Down Link	971

Contents

Modulation Accuracy (Rho)—Scramble Code Offset [BTS only]	971
Modulation Accuracy (Rho)—Scramble Code Type [BTS only]	972
Modulation Accuracy (Rho)—Scramble Code Up Link [MS Only]	973
Modulation Accuracy (Rho)—Synchronization Symbol Spread Code	974
Modulation Accuracy (Rho)—Synchronization Symbol Spread Rate	975
Modulation Accuracy (Rho)—Trigger Source	976
Reference Oscillator Commands	977
Reference Oscillator External Frequency	977
Reference Oscillator Rear-Panel Output	978
Reference Oscillator Source	978
Spectrum Emission Mask Measurement (Spurious Emissions)	979
Spectrum Emission Mask—Average Count	979
Spectrum Emission Mask—Averaging State	979
Spectrum Emission Mask—Reference Channel Integration Bandwidth	980
Spectrum Emission Mask—Reference Channel Resolution Bandwidth	981
Spectrum Emission Mask—Auto Mode for Reference Channel Resolution Bandwidth	982
Spectrum Emission Mask—Detector Mode	983
Spectrum Emission Mask—Root Raised Cosine Filter Alpha	983
Spectrum Emission Mask—Root Raised Cosine Filter Control	984
Spectrum Emission Mask—Channel Frequency Span	984
Spectrum Emission Mask—Reference Channel Step Frequency	985
Spectrum Emission Mask—Auto Mode for Reference Channel Step Frequency	986
Spectrum Emission Mask—Offset Resolution Bandwidth	987
Spectrum Emission Mask—Auto Offset Resolution Bandwidth	988
Spectrum Emission Mask—Offset Resolution Bandwidth Multiplier	989
Spectrum Emission Mask—Offset Start Frequency	990
Spectrum Emission Mask—Offset Step Frequency	991
Spectrum Emission Mask—Auto Offset Step Frequency	992
Spectrum Emission Mask—Offset Stop Frequency	993
Spectrum Emission Mask—Offset Relative Attenuation	994
Spectrum Emission Mask—Offset Frequency Side	995
Spectrum Emission Mask—Offset Start Absolute Power Limit	996
Spectrum Emission Mask—Offset Start Relative Power Limit	998
Spectrum Emission Mask—Offset Measurement State	999
Spectrum Emission Mask—Offset Stop Absolute Power Limit	1000
Spectrum Emission Mask—Couple Offset Stop Absolute Power Limit	1002
Spectrum Emission Mask—Offset Stop Relative Power Limit	1003
Spectrum Emission Mask—Couple Offset Stop Relative Power Limit	1004
Spectrum Emission Mask—Offset Channel Fail Condition	1005
Spectrum Emission Mask—Region Resolution Bandwidth	1006
Spectrum Emission Mask—Auto Region Resolution Bandwidth	1007
Spectrum Emission Mask—Region Start Frequency	1008
Spectrum Emission Mask—Region Step Frequency	1009
Spectrum Emission Mask—Auto Region Step Frequency	1010
Spectrum Emission Mask—Region Stop Frequency	1011
Spectrum Emission Mask—Region Relative Attenuation	1012
Spectrum Emission Mask—Region Start Absolute Power Limit	1013
Spectrum Emission Mask—Region Start Relative Power Limit	1014
Spectrum Emission Mask—Control Region List State	1015

Spectrum Emission Mask—Region Stop Absolute Power Limit	1016
Spectrum Emission Mask—Couple Region Stop Absolute Power Limit	1017
Spectrum Emission Mask—Region Stop Relative Power Limit	1018
Spectrum Emission Mask—Couple Region Stop Relative Power Limit	1019
Spectrum Emission Mask—Region Limit Test Fail Condition	1020
Spectrum Emission Mask—Spectrum Segment	1021
Spectrum Emission Mask—Measurement Interval	1021
Spectrum Emission Mask—Trigger Source	1022
Spectrum Emission Mask—Power Reference	1022
Spectrum (Frequency-Domain) Measurement	1023
Spectrum—Data Acquisition Packing	1023
Spectrum—ADC Dither Control	1024
Spectrum—ADC Range	1024
Spectrum—Average Clear	1026
Spectrum—Number of Averages	1026
Spectrum—Averaging State	1027
Spectrum—Averaging Termination Control	1027
Spectrum—Averaging Type	1027
Spectrum—Select Pre-FFT Bandwidth	1028
Spectrum—IF Flatness Corrections	1029
Spectrum—Pre-ADC Bandpass Filter	1029
Spectrum—Pre-FFT BW	1030
Spectrum—Pre-FFT BW Filter Type	1031
Spectrum—Resolution BW	1031
Spectrum—Resolution BW Auto	1032
Spectrum—Decimation of Spectrum Display	1033
Spectrum—FFT Length	1033
Spectrum—FFT Length Auto	1034
Spectrum—FFT Minimum Points in Resolution BW	1035
Spectrum—Window Delay	1035
Spectrum—Window Length	1036
Spectrum—FFT Window	1036
Spectrum—Frequency Span	1037
Spectrum—Sweep (Acquisition) Time	1038
Spectrum—Sweep (Acquisition) Time Auto	1038
Spectrum—Trigger Source	1039
Waveform (Time-Domain) Measurement	1040
Waveform—Data Acquisition Packing	1040
Waveform—ADC Dither Control	1041
Waveform—Pre-ADC Bandpass Filter	1041
Waveform—ADC Range	1042
Waveform—Sample Period (Aperture) Setting	1043
Waveform—Number of Averages	1043
Waveform—Averaging State	1044
Waveform—Averaging Termination Control	1044
Waveform—Averaging Type	1045
Waveform—Resolution BW	1045
Waveform—Query Actual Resolution Bandwidth	1046
Waveform—Resolution BW Filter Type	1047

Contents

Waveform—Decimation of Waveform Display	1047
Waveform—Control Decimation of Waveform Display	1048
Waveform—Sweep (Acquisition) Time	1048
Waveform—Trigger Source	1049
TRIGger Subsystem	1050
Automatic Trigger Control	1050
Automatic Trigger Time	1051
External Trigger Delay	1051
External Trigger Level	1052
External Trigger Slope	1052
Frame Trigger Adjust	1052
Frame Trigger Period	1053
Trigger Holdoff	1054
Video (IF) Trigger Delay	1054
Video (IF) Trigger Level	1055
Video (IF) Trigger Slope	1055
RF Burst Trigger Delay	1055
RF Burst Trigger Level	1056
RF Burst Trigger Slope	1056

List of Commands

<code>[:SENSe]:CDPower:SBOundary:LIST:MS:APPend <symbol_rate>, <code_num>, IPH QPH</code>	800
<code>[:SENSe]:CDPower:SBOundary:LIST:MS:NCHannels?</code>	809
<code>[:SENSe]:PCONtrol:SBOundary:LIST:MS:CHANnel? <entry_id>.</code>	892
<code>[:SENSe]:RHO:SBOundary:LIST:MS:CHANnel? <entry_id>.</code>	956
<code>[:SENSe]:RHO:SBOundary:LIST:MS:INIT <symbol_rate>, <code_num>, IPH QPH</code>	949
<code>[:SENSe]:RHO:SBOundary:LIST:MS:NCHannels?</code>	958
<code>[:SENSe]:RHO:SBOundary:LIST[:BTS]:CHANnel? <entry_id>.</code>	943
<code>[:SENSe]:RHO:SBOundary:LIST[:BTS]:NCHannels?.</code>	946
<code>[:SENSe]:RHO:SBOundary:LIST[:BTS]:NCHannels?.</code>	948
<code>:CALCulate:<measurement>:MARKer:AOFF</code>	595
<code>:CALCulate:<measurement>:MARKer[1] 2 3 4:FUNcTION:RESult?</code>	596
<code>:CALCulate:<measurement>:MARKer[1] 2 3 4:MAXimum</code>	596
<code>:CALCulate:<measurement>:MARKer[1] 2 3 4:MINimum</code>	597
<code>:CALCulate:<measurement>:MARKer[1] 2 3 4:MODE POSition DELTA</code>	597
<code>:CALCulate:<measurement>:MARKer[1] 2 3 4:MODE POSition DELTA RMSDegree RMSRadian RFM RMSJitter OFF.</code>	597
<code>:CALCulate:<measurement>:MARKer[1] 2 3 4:MODE?.</code>	597
<code>:CALCulate:<measurement>:MARKer[1] 2 3 4:TRACe <trace_name>.</code>	598
<code>:CALCulate:<measurement>:MARKer[1] 2 3 4:TRACe?</code>	598
<code>:CALCulate:<measurement>:MARKer[1] 2 3 4:X <param>.</code>	602
<code>:CALCulate:<measurement>:MARKer[1] 2 3 4:X:POSition <integer></code>	603
<code>:CALCulate:<measurement>:MARKer[1] 2 3 4:X:POSition?.</code>	603
<code>:CALCulate:<measurement>:MARKer[1] 2 3 4:X?</code>	602
<code>:CALCulate:<measurement>:MARKer[1] 2 3 4:Y?</code>	604
<code>:CALCulate:<measurement>:MARKer[1] 2 3 4[:STATe] OFF ON 0 1</code>	598
<code>:CALCulate:<measurement>:MARKer[1] 2 3 4[:STATe]?.</code>	598
<code>:CALCulate:CDPower:ASET:THReshold <numeric></code>	562
<code>:CALCulate:CDPower:ASET:THReshold?.</code>	562
<code>:CALCulate:CDPower:AXIS[:MS] IPH QPH IQCombined</code>	563
<code>:CALCulate:CDPower:AXIS[:MS]?</code>	563
<code>:CALCulate:CDPower:DBITs[:FORMat] BINary TRISate</code>	564

List of Commands

:CALCulate:CDPower:DBITs[:FORMat]?	.564
:CALCulate:CDPower:DPCH:MS:CONFigure C1 C2WDPdch C2WODpdch C3	.578
:CALCulate:CDPower:DPCH:MS:CONFigure?	.578
:CALCulate:CDPower:DTXBurst 0 1 OFF ON	.564
:CALCulate:CDPower:DTXBurst?	.564
:CALCulate:CDPower:IQPHase:ROtation <real>	.565
:CALCulate:CDPower:IQPHase:ROtation?	.565
:CALCulate:CDPower:MARKer:TRACe CDPower EVM MERRor PERRor SPOWer CPOWer CDError	.565
:CALCulate:CDPower:MARKer:TRACe?	.565
:CALCulate:CDPower:MTYPE AUTO QPSK QAM16	.566
:CALCulate:CDPower:MTYPE?	.566
:CALCulate:CDPower:PACKed OFF PKM1	.568
:CALCulate:CDPower:PACKed?	.568
:CALCulate:CDPower:SBOundary:COMPOSITE OFF ON 0 1	.569
:CALCulate:CDPower:SBOundary:COMPOSITE?	.569
:CALCulate:CDPower:SBOundary:SRATe <integer>	.570
:CALCulate:CDPower:SBOundary:SRATe?	.570
:CALCulate:CDPower:SEVM:FCOMpen ON OFF 1 0	.570
:CALCulate:CDPower:SEVM:FCOMpen?	.570
:CALCulate:CDPower:SEVM:PCOMpen ON OFF 1 0	.571
:CALCulate:CDPower:SEVM:PCOMpen?	.571
:CALCulate:CDPower:SPRead <integer>	.571
:CALCulate:CDPower:SPRead?	.571
:CALCulate:CDPower:SRATe <integer>	.572
:CALCulate:CDPower:SRATe?	.572
:CALCulate:CDPower:SSUPpress[:STATe] ON OFF 1 0	.573
:CALCulate:CDPower:SSUPpress[:STATe]?	.573
:CALCulate:CDPower:SWEep:OFFSet <integer>	.573
:CALCulate:CDPower:SWEep:OFFSet <time>	.573
:CALCulate:CDPower:SWEep:OFFSet?	.573

List of Commands

:CALCulate:CDPower:SWEep:TIME <float>	575
:CALCulate:CDPower:SWEep:TIME <integer>	575
:CALCulate:CDPower:SWEep:TIME?	575
:CALCulate:CDPower:TDPCh <integer>	576
:CALCulate:CDPower:TDPCh?	576
:CALCulate:CDPower:THSDpccch <integer>.	576
:CALCulate:CDPower:THSDpccch?	576
:CALCulate:CDPower:TYPE ABSolute RELative	578
:CALCulate:CDPower:TYPE?	578
:CALCulate:CLIMits:FAIL?	658
:CALCulate:DATA<n>:COMPRESS? BLOCk CFIT MAXimum MINimum MEAN DMEan RMS SAMPlE SDEViation[,<soffset>,<length>,<roffset> [,<rlimit>]]]	580
:CALCulate:DATA<n>:PEAKs? <threshold>,<excursion>[,<AMPLitude FREQuency TIME]	590
:CALCulate:DATA[n]?	580
:CALCulate:EVMQpsk:IQOffset:INCLude OFF ON 0 1	591
:CALCulate:EVMQpsk:IQOffset:INCLude?	591
:CALCulate:EVMQpsk:LIMit:FERRor <float>.	591
:CALCulate:EVMQpsk:LIMit:FERRor?	591
:CALCulate:EVMQpsk:LIMit:RMS <float>	592
:CALCulate:EVMQpsk:LIMit:RMS?	592
:CALCulate:OBW:LIMit:FBLimit <freq>	604
:CALCulate:OBW:LIMit:FBLimit?	604
:CALCulate:OBW:LIMit[:TEST] OFF ON 0 1	606
:CALCulate:OBW:LIMit[:TEST]?	606
:CALCulate:OBWidth:LIMit:FBLimit <freq>.	604
:CALCulate:OBWidth:LIMit:FBLimit?	604
:CALCulate:OBWidth:LIMit:STATe OFF ON 0 1	606
:CALCulate:OBWidth:LIMit:STATe?	606
:CALCulate:PCONtrol:MARKer[1] 2 3 4:TRACe RFENvelope SPOWer POW- er CPHase APHase DPHase.	610
:CALCulate:PCONtrol:MARKer[1] 2 3 4:TRACe?	610

List of Commands

:CALCulate:PCONtrol:PRACH:INTerval <float>606
:CALCulate:PCONtrol:PRACH:INTerval?606
:CALCulate:PCONtrol:PRACH:MLENgth <float>607
:CALCulate:PCONtrol:PRACH:MLENgth?607
:CALCulate:PCONtrol:PRACH:OFFSet <float>607
:CALCulate:PCONtrol:PRACH:OFFSet?607
:CALCulate:PCONtrol:PRACH:PLENgth <float>608
:CALCulate:PCONtrol:PRACH:PLENgth?608
:CALCulate:PCONtrol:SLOT:DELay <float>608
:CALCulate:PCONtrol:SLOT:DELay?608
:CALCulate:PCONtrol:SLOT:INTerval <real>609
:CALCulate:PCONtrol:SLOT:INTerval?609
:CALCulate:PCONtrol:SLOT:LENGth <real>610
:CALCulate:PCONtrol:SLOT:LENGth?610
:CALCulate:PSTatic:STORe:REFerence ON 1611
:CALCulate:RHO:ASET:THReshold <real>611
:CALCulate:RHO:ASET:THReshold:AUTO OFF ON 0 1611
:CALCulate:RHO:ASET:THReshold:AUTO OFF ON 0 1613
:CALCulate:RHO:ASET:THReshold:AUTO?611
:CALCulate:RHO:ASET:THReshold:AUTO?613
:CALCulate:RHO:ASET:THReshold?611
:CALCulate:RHO:DTXBurst 0 1 OFF ON612
:CALCulate:RHO:DTXBurst?612
:CALCulate:RHO:IQOFFset:INCLude OFF ON 0 1613
:CALCulate:RHO:IQOFFset:INCLude?613
:CALCulate:RHO:LIMit:CDErRor <float>614
:CALCulate:RHO:LIMit:CDErRor?614
:CALCulate:RHO:LIMit:CPICH[:BTS] <float>614
:CALCulate:RHO:LIMit:CPICH[:BTS]:POWer <float>615
:CALCulate:RHO:LIMit:CPICH[:BTS]:POWer?615
:CALCulate:RHO:LIMit:CPICH[:BTS]?614

List of Commands

:CALCulate:RHO:LIMit:FERRor <float>	615
:CALCulate:RHO:LIMit:FERRor?	615
:CALCulate:RHO:LIMit:PEAK <real>	617
:CALCulate:RHO:LIMit:PEAK?	617
:CALCulate:RHO:LIMit:RHO <float>	616
:CALCulate:RHO:LIMit:RHO?	616
:CALCulate:RHO:LIMit:RMS <float>	616
:CALCulate:RHO:LIMit:RMS?	616
:CALCulate:RHO:MARKer:TRACe CDPower EVM MERRor PERRor	618
:CALCulate:RHO:MARKer:TRACe?	618
:CALCulate:RHO:SWEep:OFFSet <integer>	617
:CALCulate:RHO:SWEep:OFFSet?	617
:CALCulate:SPECtrum:MARKer:IQ [1] 2 3 4?	618
:CALCulate:WAVEform:MARKer:IQ [1] 2 3 4?	618
:CONFigure:<measurement>	619
:CONFigure:ACP	658
:CONFigure:AREFERENCE	666
:CONFigure:CDPower	667
:CONFigure:CHPower	702
:CONFigure:EVMQpsk	703
:CONFigure:IM	706
:CONFigure:MCPower	709
:CONFigure:OBW	711
:CONFigure:PCONtrol	713
:CONFigure:PSTatistic	718
:CONFigure:PVTime	720
:CONFigure:RHO	724
:CONFigure:SEMAsk	746
:CONFigure:SPECtrum	752
:CONFigure:TBFRequency	754
:CONFigure:WAVEform	755

List of Commands

:CONFigure?658
:DISPlay:ACP:VIEW BGRaph SPEctrum620
:DISPlay:ACP:VIEW?620
:DISPlay:ENABle OFF ON 0 1622
:DISPlay:ENABle?622
:DISPlay:FORMat:ZOOM622
:DISPlay:FSCReen[:STATe] OFF ON 0 1623
:DISPlay:FSCReen[:STATe]?623
:DISPlay:FSCREEN FULLSCREEN[:STATe] ON OFF 1 0623
:DISPlay:FSCREEN FULLSCREEN[:STATe]?623
:DISPlay:PCONtrol:VIEW POWer PHASe624
:DISPlay:PCONtrol:VIEW?624
:DISPlay:PVTime:LIMit:MASK OFF ON 0 1624
:DISPlay:PVTime:LIMit:MASK?624
:DISPlay:PVTime:VIEW ALL BOTH625
:DISPlay:PVTime:VIEW ALL BOTH A B C D E625
:DISPlay:PVTime:VIEW?625
:DISPlay:RHO:VIEW ERRor POLar PGRaph TABLe SUMMary CDERror626
:DISPlay:RHO:VIEW?626
:DISPlay:SPEctrum[n]:WINDow[m]:TRACe:Y[:SCALe]:PDIVision <power>627
:DISPlay:SPEctrum[n]:WINDow[m]:TRACe:Y[:SCALe]:PDIVision?627
:DISPlay:SPEctrum[n]:WINDow[m]:TRACe:Y[:SCALe]:RLEVel <power>628
:DISPlay:SPEctrum[n]:WINDow[m]:TRACe:Y[:SCALe]:RLEVel?628
:DISPlay:TRACe[n][:STATe] OFF ON 0 1629
:DISPlay:TRACe[n][:STATe]?629
:DISPlay:WAVeform[n]:WINDow[m]:TRACe:Y[:SCALe]:PDIVision <power>634
:DISPlay:WAVeform[n]:WINDow[m]:TRACe:Y[:SCALe]:PDIVision?634
:DISPlay:WAVeform[n]:WINDow[m]:TRACe:Y[:SCALe]:RLEVel <power>635
:DISPlay:WAVeform[n]:WINDow[m]:TRACe:Y[:SCALe]:RLEVel?635
:DISPlay:WINDow:SElect 1 2 3 4636
:DISPlay:WINDow:SElect?636

List of Commands

:DISPlay:WINDow:TRACe:Y[:SCALe]:PDIVision <real>	643
:DISPlay:WINDow:TRACe:Y[:SCALe]:PDIVision?	643
:DISPlay:WINDow:TRACe:Y[:SCALe]:RLEVel <real>	644
:DISPlay:WINDow:TRACe:Y[:SCALe]:RLEVel?	644
:DISPlay:WINDow[:SElect] <number>	636
:DISPlay:WINDow[:SElect]?	636
:DISPlay:WINDow[1] 2 3 4:TRACe:X[:SCALe]:COUPle 0 1 Off On	637
:DISPlay:WINDow[1] 2 3 4:TRACe:X[:SCALe]:COUPle?	637
:DISPlay:WINDow[1] 2 3 4:TRACe:X[:SCALe]:PDIVision <number>	638
:DISPlay:WINDow[1] 2 3 4:TRACe:X[:SCALe]:PDIVision?	638
:DISPlay:WINDow[1] 2 3 4:TRACe:X[:SCALe]:RLEVel <number>	639
:DISPlay:WINDow[1] 2 3 4:TRACe:X[:SCALe]:RLEVel?	639
:DISPlay:WINDow[1] 2 3 4:TRACe:X[:SCALe]:RPOStion <number 0.0 to 10.0>	640
:DISPlay:WINDow[1] 2 3 4:TRACe:X[:SCALe]:RPOStion?	640
:DISPlay:WINDow[1] 2 3 4:TRACe:Y[:SCALe]:COUPle 0 1 Off On	640
:DISPlay:WINDow[1] 2 3 4:TRACe:Y[:SCALe]:COUPle?	640
:DISPlay:WINDow[1] 2 3 4:TRACe:Y[:SCALe]:PDIVision <number>	641
:DISPlay:WINDow[1] 2 3 4:TRACe:Y[:SCALe]:PDIVision?	641
:DISPlay:WINDow[1] 2 3 4:TRACe:Y[:SCALe]:RLEVel <number>	642
:DISPlay:WINDow[1] 2 3 4:TRACe:Y[:SCALe]:RLEVel?	642
:DISPlay:WINDow[1] 2 3 4:TRACe:Y[:SCALe]:RPOStion <number 0.0 to 10.0>	643
:DISPlay:WINDow[1] 2 3 4:TRACe:Y[:SCALe]:RPOStion?	643
:FETCh:<measurement>[n]?	645
:FETCh:ACP[n]?	658
:FETCh:AREFERENCE[n]?	666
:FETCh:CDPower[n]?	667
:FETCh:CHPower[n]?	702
:FETCh:EVMQpsk[n]?	703
:FETCh:IM[n]?	706
:FETCh:MCPower[n]?	709
:FETCh:OBW[n]?	711

List of Commands

:FETCh:PCONtrol[n]?	713
:FETCh:PStAtistic[n]?	718
:FETCh:PVTime[n]?	720
:FETCh:RHO[n]?	724
:FETCh:SEMAsk[n]?	746
:FETCh:SPECtrum[n]?	752
:FETCh:TBFRequency[n]?	754
:FETCh:WAVEform[n]?	755
:FORMat:BORDER NORMAl SWAPped	646
:FORMat:BORDER?	646
:FORMat[:DATA] ASCii REAL,32 REAL,64	646
:FORMat[:DATA]?	646
:FORMat[:TRACe][:DATA] ASCii INTeger,16 INTeger,32 REAL,32 REAL,64 UINteger,16	646
:FORMat[:TRACe][:DATA] ASCii REAL[,32]	646
:FORMat[:TRACe][:DATA]?	646
:FORMat[:TRACe][:DATA]?	646
:INITiate:<measurement>	648
:INITiate:ACP	658
:INITiate:AREFERENCE	666
:INITiate:CDPower	667
:INITiate:CHPower	702
:INITiate:CONTinuous OFF ON 0 1	648
:INITiate:CONTinuous?	648
:INITiate:EVMQpsk	703
:INITiate:IM	706
:INITiate:MCPower	709
:INITiate:OBW	711
:INITiate:PCONtrol	713
:INITiate:PStAtistic	718
:INITiate:PVTime	720
:INITiate:REStart	649

List of Commands

:INITiate:RHO	724
:INITiate:SEMask	746
:INITiate:SPECtrum	752
:INITiate:TBFRequency	754
:INITiate:WAVEform	755
:INITiate[:IMMediate]	649
:INSTrument:CATalog?	650
:INSTrument:CATalog[:FULL]?	650
:INSTrument:NSElect <integer>	650
:INSTrument:NSElect?	650
:INSTrument[:SElect] BASIC SERVICE CDMA CDMA2K GSM EDGE GSM IDEN NADC PDC WCDMA CDMA1XEV DMODULATION	652
:INSTrument[:SElect] SA PNOISE BASIC CDMA CDMA2K EDGE GSM NADC PDC WCDMA CDMA1XEV NFIGURE DMODULATION WLAN MRECEIVE TDSCDMA	652
:INSTrument[:SElect]?	652
:MEASure:ACP[n]?	658
:MEASure:AREFERENCE[n]?	666
:MEASure:CDPower[n]?	667
:MEASure:CHPower[n]?	702
:MEASure:EVMQpsk[n]?	703
:MEASure:IM[n]?	706
:MEASure:MCPower[n]?	709
:MEASure:OBW[n]?	711
:MEASure:PCONtrol[n]?	713
:MEASure:PStatistic[n]?	718
:MEASure:PVTime[n]?	720
:MEASure:RHO[n]?	724
:MEASure:SEMask[n]?	746
:MEASure:SPECtrum[n]?	752
:MEASure:TBFRequency[n]?	754
:MEASure:WAVEform[n]?	755

List of Commands

:READ:<measurement>[n]?	.757
:READ:ACP[n]?	.658
:READ:AREFERENCE[n]?	.666
:READ:CDPower[n]?	.667
:READ:CHPower[n]?	.702
:READ:EVMQpsk[n]?	.703
:READ:IM[n]?	.706
:READ:MCPower[n]?	.709
:READ:OBW[n]?	.711
:READ:PCONTrol[n]?	.713
:READ:PSTatistic[n]?	.718
:READ:PVTime[n]?	.720
:READ:RHO[n]?	.724
:READ:SEMask[n]?	.746
:READ:SPECTrum[n]?	.752
:READ:TBFRequency[n]?	.754
:READ:WAVeform[n]?	.755
:SENSe]:CDPower:SBOundary:LIST:MS:INIT <symbol_rate>, <code_num>, IPH QPH	.797
:TRIGger[:SEQuence]:AUTO:STATe OFF ON 0 1	.1050
:TRIGger[:SEQuence]:AUTO:STATe?	.1050
:TRIGger[:SEQuence]:AUTO[:TIME] <time>	.1051
:TRIGger[:SEQuence]:AUTO[:TIME]?	.1051
:TRIGger[:SEQuence]:EXTErnal[1] 2:DELay <time>	.1051
:TRIGger[:SEQuence]:EXTErnal[1] 2:DELay?	.1051
:TRIGger[:SEQuence]:EXTErnal[1] 2:LEVel <voltage>	.1052
:TRIGger[:SEQuence]:EXTErnal[1] 2:LEVel?	.1052
:TRIGger[:SEQuence]:EXTErnal[1] 2:SLOPe NEGative POSitive	.1052
:TRIGger[:SEQuence]:EXTErnal[1] 2:SLOPe?	.1052
:TRIGger[:SEQuence]:FRAMe:ADJJust <time>	.1052
:TRIGger[:SEQuence]:FRAMe:PERiod <time>	.1053
:TRIGger[:SEQuence]:FRAMe:PERiod?	.1053

List of Commands

:TRIGger[:SEQuence]:HOLDoff <time>	1054
:TRIGger[:SEQuence]:HOLDoff?	1054
:TRIGger[:SEQuence]:IF:DELay <time>.....	1054
:TRIGger[:SEQuence]:IF:DELay?	1054
:TRIGger[:SEQuence]:IF:LEVel <ampl>.....	1055
:TRIGger[:SEQuence]:IF:LEVel?	1055
:TRIGger[:SEQuence]:IF:SLOPe NEGative POSitive	1055
:TRIGger[:SEQuence]:IF:SLOPe?	1055
:TRIGger[:SEQuence]:RFBurst:DELay <time>	1055
:TRIGger[:SEQuence]:RFBurst:DELay?.....	1055
:TRIGger[:SEQuence]:RFBurst:LEVel <rel_power>.....	1056
:TRIGger[:SEQuence]:RFBurst:LEVel?.....	1056
:TRIGger[:SEQuence]:RFBurst:SLOPe NEGative POSitive	1056
:TRIGger[:SEQuence]:RFBurst:SLOPe?	1056
[:SENSe]:ACP:AVERAge:COUNT <integer>	758
[:SENSe]:ACP:AVERAge:COUNT?	758
[:SENSe]:ACP:AVERAge:TCONtrol EXPOnential REPeat	759
[:SENSe]:ACP:AVERAge:TCONtrol?	759
[:SENSe]:ACP:AVERAge[:STATe] OFF ON 0 1	759
[:SENSe]:ACP:AVERAge[:STATe]?	759
[:SENSe]:ACP:BANDwidth[n] BWIDth[n]:INTegration <freq>.....	760
[:SENSe]:ACP:BANDwidth[n] BWIDth[n]:INTegration?	760
[:SENSe]:ACP:BANDwidth[n] BWIDth[n]:INTegration[m] <freq>	760
[:SENSe]:ACP:BANDwidth[n] BWIDth[n]:INTegration[m]?	760
[:SENSe]:ACP:BANDwidth BWIDth:INTegration <freq>.....	760
[:SENSe]:ACP:BANDwidth BWIDth:INTegration?.....	760
[:SENSe]:ACP:FAST:OFFSet:ADC:RANGe?.....	762
[:SENSe]:ACP:FAST:OFFSet:ADC:RANGe AUTO APEak APLock M6 P0 P6 P12 P18 P24	762
[:SENSe]:ACP:FAST:OFFSet:ADC:RANGe AUTO APEak APLock NONE P0 P6 P12 P18	762
[:SENSe]:ACP:FAST:OFFSet:RATTenuation <rel power>.....	763

List of Commands

[[:SENSe]:ACP:FAST:OFFSet:RATTenuation?	763
[[:SENSe]:ACP:FILTer[:RRC]:ALPHa <numeric>	763
[[:SENSe]:ACP:FILTer[:RRC]:ALPHa?	763
[[:SENSe]:ACP:FILTer[:RRC][:STATe] OFF ON 0 1	763
[[:SENSe]:ACP:FILTer[:RRC][:STATe]?	763
[[:SENSe]:ACP:OFFSet:ABSolute <power>	764
[[:SENSe]:ACP:OFFSet:ABSolute?	764
[[:SENSe]:ACP:OFFSet:BANDwidth BWIDth <res_bw>	767
[[:SENSe]:ACP:OFFSet:BANDwidth BWIDth <res_bw>	767
[[:SENSe]:ACP:OFFSet:BANDwidth BWIDth?	767
[[:SENSe]:ACP:OFFSet:BANDwidth BWIDth?	767
[[:SENSe]:ACP:OFFSet:LIST:ABSolute <power>,<power>	764
[[:SENSe]:ACP:OFFSet:LIST:ABSolute <power>,<power>,<power>,<power>,<power>	764
[[:SENSe]:ACP:OFFSet:LIST:ABSolute?	764
[[:SENSe]:ACP:OFFSet:LIST:ABSolute?	764
[[:SENSe]:ACP:OFFSet:LIST:BANDwidth BWIDth <res_bw>,<res_bw>,<res_bw>,<res_bw>,<res_bw>	767
[[:SENSe]:ACP:OFFSet:LIST:BANDwidth BWIDth?	767
[[:SENSe]:ACP:OFFSet:LIST:RCARrier <rel_power>,<rel_power>	774
[[:SENSe]:ACP:OFFSet:LIST:RCARrier <rel_power>,<rel_power>,<rel_power>,<rel_power>,<rel_power>	774
[[:SENSe]:ACP:OFFSet:LIST:RCARrier?	774
[[:SENSe]:ACP:OFFSet:LIST:RCARrier?	774
[[:SENSe]:ACP:OFFSet:LIST:RPSDensity <rel_power>,<rel_power>,<rel_power>,<rel_power>,<rel_power>	777
[[:SENSe]:ACP:OFFSet:LIST:RPSDensity?	777
[[:SENSe]:ACP:OFFSet:LIST:STATe OFF ON 0 1, OFF ON 0 1, OFF ON 0 1, OFF ON 0 1, OFF ON 0 1	779
[[:SENSe]:ACP:OFFSet:LIST:STATe?	779
[[:SENSe]:ACP:OFFSet:LIST:TEST ABSolute AND OR RELative, ABSolute AND OR RELative, ABSolute AND OR RELative, ABSolute AND OR RELative, ABSolute AND OR RELative	780
[[:SENSe]:ACP:OFFSet:LIST:TEST?	780

List of Commands

[:SENSe]:ACP:OFFSet:LIST[:FREQuency] <f_offset>,<f_offset>	770
[:SENSe]:ACP:OFFSet:LIST[:FREQuency] <f_offset>,<f_offset>,<f_offset>,<f_offset>,<f_offset>	770
[:SENSe]:ACP:OFFSet:LIST[:FREQuency]?	770
[:SENSe]:ACP:OFFSet:LIST[:FREQuency]?	770
[:SENSe]:ACP:OFFSet:RCARrier <rel_power>	774
[:SENSe]:ACP:OFFSet:RCARrier?	774
[:SENSe]:ACP:OFFSet:RPSDensity <rel_power>	777
[:SENSe]:ACP:OFFSet:RPSDensity?	777
[:SENSe]:ACP:OFFSet:TEST ABSolute AND OR RELative	780
[:SENSe]:ACP:OFFSet:TEST?	780
[:SENSe]:ACP:OFFSet[:FREQuency] <f_offset>	770
[:SENSe]:ACP:OFFSet[:FREQuency]?	770
[:SENSe]:ACP:OFFSet[n]:LIST:ABSolute <power>,<power>,<power>,<power>,<power>	764
[:SENSe]:ACP:OFFSet[n]:LIST:ABSolute?	764
[:SENSe]:ACP:OFFSet[n]:LIST:BANDwidth BWIDth <res_bw>,<res_bw>,<res_bw>,<res_bw>,<res_bw>	767
[:SENSe]:ACP:OFFSet[n]:LIST:BANDwidth BWIDth?	767
[:SENSe]:ACP:OFFSet[n]:LIST:RCARrier <rel_power>,<rel_power>,<rel_power>,<rel_power>,<rel_power>	774
[:SENSe]:ACP:OFFSet[n]:LIST:RCARrier?	774
[:SENSe]:ACP:OFFSet[n]:LIST:RPSDensity <rel_power>,<rel_power>,<rel_power>,<rel_power>,<rel_power>	777
[:SENSe]:ACP:OFFSet[n]:LIST:RPSDensity?	777
[:SENSe]:ACP:OFFSet[n]:LIST:STATe OFF ON 0 1, OFF ON 0 1, OFF ON 0 1, OFF ON 0 1, OFF ON 0 1	779
[:SENSe]:ACP:OFFSet[n]:LIST:STATe?	779
[:SENSe]:ACP:OFFSet[n]:LIST:TEST ABSolute AND OR RELative, ABSolute AND OR RELative, ABSolute AND OR RELative, ABSolute AND OR RELative, ABSolute AND OR RELative	780
[:SENSe]:ACP:OFFSet[n]:LIST:TEST?	780
[:SENSe]:ACP:OFFSet[n]:LIST[:FREQuency] <f_offset>,<f_offset>,<f_offset>,<f_offset>,<f_offset>	771

List of Commands

[:SENSe]:ACP:OFFSet[n]:LIST[:FREQuency]?	771
[:SENSe]:ACP:OFFSet[n]:LIST[m]:BANDwidth BWIDth <res_bw>,<res_bw>,<res_bw>,<res_bw>,<res_bw>	767
[:SENSe]:ACP:OFFSet[n]:LIST[m]:BANDwidth BWIDth?	767
[:SENSe]:ACP:OFFSet[n]:LIST[m]:RCARrier <rel_power>,<rel_power>,<rel_power>,<rel_power>,<rel_power>.....	774
[:SENSe]:ACP:OFFSet[n]:LIST[m]:RCARrier?	774
[:SENSe]:ACP:OFFSet[n]:LIST[m]:RPSDensity <rel_power>,<rel_power>,<rel_power>,<rel_power>,<rel_power>.....	777
[:SENSe]:ACP:OFFSet[n]:LIST[m]:RPSDensity?	777
[:SENSe]:ACP:OFFSet[n]:LIST[m]:STATe OFF ON 0 1, OFF ON 0 1, OFF ON 0 1, OFF ON 0 1, OFF ON 0 1.....	779
[:SENSe]:ACP:OFFSet[n]:LIST[m]:STATe?	779
[:SENSe]:ACP:OFFSet[n]:LIST[m]:TEST, ABSolute AND OR RELative, ABSolute AND OR RELative, ABSolute AND OR RELative, ABSolute AND OR RELative.	780
[:SENSe]:ACP:OFFSet[n]:LIST[m][:FREQuency] <f_offset>,<f_offset>,<f_offset>,<f_offset>,<f_offset>.....	771
[:SENSe]:ACP:OFFSet[n]:LIST[m][:FREQuency]?	771
[:SENSe]:ACP:OFFSet[n]:LIST[nm]:TEST?	780
[:SENSe]:ACP:SWEep:BANDwidth BWIDth[:RESolution] <freq>	782
[:SENSe]:ACP:SWEep:BANDwidth BWIDth[:RESolution]:AUTO OFF ON 0 1.....	782
[:SENSe]:ACP:SWEep:BANDwidth BWIDth[:RESolution]:AUTO?	782
[:SENSe]:ACP:SWEep:BANDwidth BWIDth[:RESolution]?	782
[:SENSe]:ACP:SWEep:DETEctor[:FUNCTion] AAVerage POSitive	783
[:SENSe]:ACP:SWEep:DETEctor[:FUNCTion]?	783
[:SENSe]:ACP:SWEep:TIME <seconds>	783
[:SENSe]:ACP:SWEep:TIME?	783
[:SENSe]:ACP:SWEep:TYPE FAST FFT SWEep.....	784
[:SENSe]:ACP:SWEep:TYPE FFT SWEep	784
[:SENSe]:ACP:SWEep:TYPE?	784
[:SENSe]:ACP:SWEep:TYPE?	784
[:SENSe]:ACP:TYPE PSDRef TPreF	785
[:SENSe]:ACP:TYPE?	785

List of Commands

[[:SENSe]:CDPower:ADC:RANGe AUTO APEak APLock M6 P0 P6 P12 P18 P24	787
[[:SENSe]:CDPower:ADC:RANGe AUTO APEak APLock NONE P0 P6 P12 P18	787
[[:SENSe]:CDPower:ADC:RANGe?	787
[[:SENSe]:CDPower:ALPHa <numeric>.	789
[[:SENSe]:CDPower:ALPHa?	789
[[:SENSe]:CDPower:CAPTure:TIME <numeric>.	790
[[:SENSe]:CDPower:CAPTure:TIME?.	790
[[:SENSe]:CDPower:CRATe <freq>.	791
[[:SENSe]:CDPower:CRATe?	791
[[:SENSe]:CDPower:FERRor:TRANge WIDE NORMal	791
[[:SENSe]:CDPower:FERRor:TRANge?	791
[[:SENSe]:CDPower:MCEStimator OFF ON 0 1	792
[[:SENSe]:CDPower:MCEStimator:TIMing CHANnel GLOBal	795
[[:SENSe]:CDPower:MCEStimator:TIMing?	795
[[:SENSe]:CDPower:MCEStimator?	792
[[:SENSe]:CDPower:MICH:SPRead <integer>.	793
[[:SENSe]:CDPower:MICH:SPRead?	793
[[:SENSe]:CDPower:MICH:STATe OFF ON 0 1	793
[[:SENSe]:CDPower:MICH:STATe?.	793
[[:SENSe]:CDPower:PRACH:SIGNature <integer>	795
[[:SENSe]:CDPower:PRACH:SIGNature:AUTO OFF ON 0 1	795
[[:SENSe]:CDPower:PRACH:SIGNature:AUTO?	795
[[:SENSe]:CDPower:PRACH:SIGNature?	795
[[:SENSe]:CDPower:SBOundary:LIST:MS:CHANnel? <entry_id>.	807
[[:SENSe]:CDPower:SBOundary:LIST:MS:REPLace <entry_id>, <symbol_rate>, <code_num>, IPH QPH	803
[[:SENSe]:CDPower:SBOundary:LIST[:BTS]:APPend <symbol_rate>, <code_num>, QPSK QAM16	814
[[:SENSe]:CDPower:SBOundary:LIST[:BTS]:CHANnel? <entry_id>	822
[[:SENSe]:CDPower:SBOundary:LIST[:BTS]:INIT <symbol_rate>, <code_num>, QPSK QAM16	810
[[:SENSe]:CDPower:SBOundary:LIST[:BTS]:NCHannels?	810

List of Commands

[[:SENSe]:CDPower:SBOundary:LIST[:BTS]:PRESet TM1D16 TM1D32 TM1D64 TM1D16SC TM1D32SC TM1D64SC TM2 TM2SC TM3D16 TM3 D32 TM3D16SC TM3D32SC TM4 TM4CP TM5H2 TM5H4 TM5H8	825
[[:SENSe]:CDPower:SBOundary:LIST[:BTS]:REPLace <entry_id>, <symbol_rate>, <code_num>, QPSK QAM16	818
[[:SENSe]:CDPower:SBOundary[:BTS] AU- TO TM1D16 TM1D32 TM1D64 TM1D16SC TM1D32SC TM1D64SC TM2 TM2SC TM3D16 TM3D32 TM3D16SC TM3D32SC TM4 TM4CP TM5H2 TM5H4 TM5H8 CUSTom	827
[[:SENSe]:CDPower:SBOundary[:BTS]?	827
[[:SENSe]:CDPower:SFORmat:MS SF0 SF1 SF2 SF3 SF4 SF5 AUTO	834
[[:SENSe]:CDPower:SFORmat:MS	839
[[:SENSe]:CDPower:SFORmat:MS	839
[[:SENSe]:CDPower:SFORmat:MS?	834
[[:SENSe]:CDPower:SPECtrum INVert NORMal	836
[[:SENSe]:CDPower:SPECtrum?	836
[[:SENSe]:CDPower:SSLot:NUMBer <integer>	837
[[:SENSe]:CDPower:SSLot:NUMBer?	837
[[:SENSe]:CDPower:SSLot[:STATe] OFF ON 0 1	837
[[:SENSe]:CDPower:SSLot[:STATe]?	837
[[:SENSe]:CDPower:SYNC:MS DPCCh PMESsage	839
[[:SENSe]:CDPower:SYNC:MS?	839
[[:SENSe]:CDPower:SYNC:SCRamble:MS <integer>	842
[[:SENSe]:CDPower:SYNC:SCRamble:MS?	842
[[:SENSe]:CDPower:SYNC:SCRamble[:BTS] <integer>	840
[[:SENSe]:CDPower:SYNC:SCRamble[:BTS]:OFFSet <integer>	841
[[:SENSe]:CDPower:SYNC:SCRamble[:BTS]:OFFSet?	841
[[:SENSe]:CDPower:SYNC:SCRamble[:BTS]:TYPE LEFT RIGHT STANdard	842
[[:SENSe]:CDPower:SYNC:SCRamble[:BTS]:TYPE?	842
[[:SENSe]:CDPower:SYNC:SCRamble[:BTS]?	840
[[:SENSe]:CDPower:SYNC:SYMBOL:SPRead <integer>	843
[[:SENSe]:CDPower:SYNC:SYMBOL:SPRead?	843
[[:SENSe]:CDPower:SYNC:SYMBOL:SRATe <integer>	844
[[:SENSe]:CDPower:SYNC:SYMBOL:SRATe?	844

List of Commands

[[:SENSe]:CDPower:SYNC[:BTS] CPICh SCH SYMBol A2CPich A1Sch A2Sch.	838
[[:SENSe]:CDPower:SYNC[:BTS]?	838
[[:SENSe]:CDPower:TRIGger:SOURce IMMEDIATE IF EXTERNAL[1] EXTERNAL2 RFBURST FRAME.	845
[[:SENSe]:CDPower:TRIGger:SOURce?	845
[[:SENSe]:CHPower:AVERage:COUNt <integer>	847
[[:SENSe]:CHPower:AVERage:COUNt?	847
[[:SENSe]:CHPower:AVERage:TCONtrol EXPONENTIAL REPEAT	848
[[:SENSe]:CHPower:AVERage:TCONtrol?	848
[[:SENSe]:CHPower:AVERage[:STATe] OFF ON 0 1	847
[[:SENSe]:CHPower:AVERage[:STATe]?	847
[[:SENSe]:CHPower:BANDwidth BWIDth:INtegration <freq>	848
[[:SENSe]:CHPower:BANDwidth BWIDth:INtegration?	848
[[:SENSe]:CHPower:FREQuency:SPAN <freq>	849
[[:SENSe]:CHPower:FREQuency:SPAN?	849
[[:SENSe]:CHPower:POINts <integer>	849
[[:SENSe]:CHPower:POINts:AUTO OFF ON 0 1	850
[[:SENSe]:CHPower:POINts:AUTO?	850
[[:SENSe]:CHPower:POINts?	849
[[:SENSe]:CHPower:SWEep:TIME <time>	850
[[:SENSe]:CHPower:SWEep:TIME:AUTO OFF ON 0 1	851
[[:SENSe]:CHPower:SWEep:TIME:AUTO?	851
[[:SENSe]:CHPower:SWEep:TIME?	850
[[:SENSe]:CHPower:TRIGger:SOURce EXTERNAL[1] EXTERNAL2 IMMEDIATE	851
[[:SENSe]:CHPower:TRIGger:SOURce?	851
[[:SENSe]:CORRection:BTS[:RF]:LOSS <rel_power>	852
[[:SENSe]:CORRection:BTS[:RF]:LOSS?	852
[[:SENSe]:CORRection:MS[:RF]:LOSS <rel_power>	852
[[:SENSe]:CORRection:MS[:RF]:LOSS?	852
[[:SENSe]:EVMQpsk:ADC:RANGe AUTO APEak APLock M6 P0 P6 P12 P18 P24	853
[[:SENSe]:EVMQpsk:ADC:RANGe AUTO APEak APLock NONE P0 P6 P12 P18.	853

List of Commands

[:SENSe]:EVMQpsk:ADC:RANGe?853
[:SENSe]:EVMQpsk:ALPHa <numeric>854
[:SENSe]:EVMQpsk:ALPHa?854
[:SENSe]:EVMQpsk:AVERage:COUNT <integer>855
[:SENSe]:EVMQpsk:AVERage:COUNT?855
[:SENSe]:EVMQpsk:AVERage:TCONtrol EXPonential REPeat855
[:SENSe]:EVMQpsk:AVERage:TCONtrol?855
[:SENSe]:EVMQpsk:AVERage[:STATe] OFF ON 0 1855
[:SENSe]:EVMQpsk:AVERage[:STATe]?855
[:SENSe]:EVMQpsk:CONStln QPSK RMC122856
[:SENSe]:EVMQpsk:CONStln?856
[:SENSe]:EVMQpsk:CRATe <freq>856
[:SENSe]:EVMQpsk:CRATe?856
[:SENSe]:EVMQpsk:RFCarrier MULTiple SINGle857
[:SENSe]:EVMQpsk:RFCarrier?857
[:SENSe]:EVMQpsk:SPECtrum INVert NORMAl857
[:SENSe]:EVMQpsk:SPECtrum?857
[:SENSe]:EVMQpsk:SWEep:POINts <integer>858
[:SENSe]:EVMQpsk:SWEep:POINts?858
[:SENSe]:EVMQpsk:TRIGger:SOURce EXTernal[1] EXTernal2 FRAMe IF IMMEDIATE RFBurst858
[:SENSe]:EVMQpsk:TRIGger:SOURce?858
[:SENSe]:FEED RF AREFERENCE IFALign WBALign859
[:SENSe]:FEED RF IQ IONLy QONLy AREFERENCE IFALign859
[:SENSe]:FEED:SOURce INPut STORed861
[:SENSe]:FEED:SOURce:CLEar860
[:SENSe]:FEED:SOURce:STORe862
[:SENSe]:FEED:SOURce?861
[:SENSe]:FEED?859
[:SENSe]:FREQuency:CENTer <freq>863
[:SENSe]:FREQuency:CENTer:STEP:AUTO OFF ON 0 1864

List of Commands

[:SENSe]:FREQUency:CENTer:STEP:AUTO?	864
[:SENSe]:FREQUency:CENTer:STEP[:INCRement] <freq>	864
[:SENSe]:FREQUency:CENTer:STEP[:INCRement]?	864
[:SENSe]:FREQUency:CENTer?	863
[:SENSe]:IM:AVERAge:COUNT <number>	865
[:SENSe]:IM:AVERAge:COUNT?	865
[:SENSe]:IM:AVERAge:TCONTrOl EXPonential REPeat	866
[:SENSe]:IM:AVERAge:TCONTrOl?	866
[:SENSe]:IM:AVERAge[:STATe] OFF ON 0 1	865
[:SENSe]:IM:AVERAge[:STATe]?	865
[:SENSe]:IM:BANDwidth BWIDth:INTegration <freq>	866
[:SENSe]:IM:BANDwidth BWIDth:INTegration?	866
[:SENSe]:IM:BANDwidth BWIDth[:RESolution] <freq>	867
[:SENSe]:IM:BANDwidth BWIDth[:RESolution]:AUTO OFF ON 0 1	867
[:SENSe]:IM:BANDwidth BWIDth[:RESolution]:AUTO?	867
[:SENSe]:IM:BANDwidth BWIDth[:RESolution]?	867
[:SENSe]:IM:FILTer[:RRC]:ALPHa <numeric>	867
[:SENSe]:IM:FILTer[:RRC]:ALPHa?	867
[:SENSe]:IM:FILTer[:RRC][:STATe] OFF ON 0 1	868
[:SENSe]:IM:FILTer[:RRC][:STATe]?	868
[:SENSe]:IM:FREQUency:AUTO OFF ON 0 1	868
[:SENSe]:IM:FREQUency:AUTO?	868
[:SENSe]:IM:FREQUency:SPAN <freq>	870
[:SENSe]:IM:FREQUency:SPAN?	870
[:SENSe]:IM:FREQUency[:BASE]:DELTA <freq>	869
[:SENSe]:IM:FREQUency[:BASE]:DELTA?	869
[:SENSe]:IM:FREQUency[:BASE]:LOWer <freq>	869
[:SENSe]:IM:FREQUency[:BASE]:LOWer?	869
[:SENSe]:IM:FREQUency[:BASE]:UPPer <freq>	870
[:SENSe]:IM:FREQUency[:BASE]:UPPer?	870
[:SENSe]:IM:MODE AUTO TWOTone TXIM	871

List of Commands

[:SENSe]:IM:MODE?871
[:SENSe]:IM:REFeRence AUTO AVERAge LOWer UPPer871
[:SENSe]:IM:REFeRence?871
[:SENSe]:MCPower:AVERAge:COUNt <integer>872
[:SENSe]:MCPower:AVERAge:COUNt?872
[:SENSe]:MCPower:AVERAge:TCONtrol EXPonential REPeat873
[:SENSe]:MCPower:AVERAge:TCONtrol?873
[:SENSe]:MCPower:AVERAge[:STATe] OFF ON 0 1872
[:SENSe]:MCPower:AVERAge[:STATe]?872
[:SENSe]:MCPower:FILTer[:RRC]:ALPHa <numeric>873
[:SENSe]:MCPower:FILTer[:RRC]:ALPHa?873
[:SENSe]:MCPower:FILTer[:RRC][:STATe] OFF ON 0 1873
[:SENSe]:MCPower:FILTer[:RRC][:STATe]?873
[:SENSe]:MCPower:FREQUency[:BASE]:DELTA <freq>874
[:SENSe]:MCPower:FREQUency[:BASE]:DELTA?874
[:SENSe]:MCPower:OFFSet:LIST:ABSolute <abs_power>,<abs_power>,<abs_power>,<abs_power> ..	874
[:SENSe]:MCPower:OFFSet:LIST:ABSolute?874
[:SENSe]:MCPower:OFFSet:LIST:RCARrier <rel_power>,<rel_power>,<rel_power>,<rel_power> ..	875
[:SENSe]:MCPower:OFFSet:LIST:RCARrier?875
[:SENSe]:MCPower:OFFSet:LIST:TEST ABSolute AND OR RELative, ABSolute AND OR RELative ..	876
[:SENSe]:MCPower:OFFSet:LIST:TEST?876
[:SENSe]:MCPower:OFFSet:SELeCt ALL TFS TOI877
[:SENSe]:MCPower:OFFSet:SELeCt?877
[:SENSe]:MCPower:REFeRence AUTO AVERAge LOWer UPPer877
[:SENSe]:MCPower:REFeRence?877
[:SENSe]:OBW:AVERAge:COUNt <integer>878
[:SENSe]:OBW:AVERAge:COUNt?878
[:SENSe]:OBW:AVERAge:TCONtrol EXPonential REPeat879
[:SENSe]:OBW:AVERAge:TCONtrol?879

List of Commands

[[:SENSe]:OBW:AVERage[:STATe] OFF ON 0 1	879
[[:SENSe]:OBW:AVERage[:STATe]?	879
[[:SENSe]:OBW:BANDwidth BWIDth[:RESolution] <freq>	880
[[:SENSe]:OBW:BANDwidth BWIDth[:RESolution]?	880
[[:SENSe]:OBW:FFT:WINDow[:TYPE] BH4Tap BLACkman FLATtop GAUSSian HAMMING HANNing KB70 KB90 KB110 UNIFORM	880
[[:SENSe]:OBW:FFT:WINDow[:TYPE]?	880
[[:SENSe]:OBW:FREQuency:SPAN <freq>	881
[[:SENSe]:OBW:FREQuency:SPAN?	881
[[:SENSe]:OBW:TRIGger:SOURce EXTernal[1] EXTernal2 FRAME IF IMMEDIATE LINE RFBurst	881
[[:SENSe]:OBW:TRIGger:SOURce EXTernal[1] EXTernal2 IF IMMEDIATE RFBurst	881
[[:SENSe]:OBW:TRIGger:SOURce EXTernal[1] EXTernal2 IF IMMEDIATE RFBurst	881
[[:SENSe]:OBW:TRIGger:SOURce?	881
[[:SENSe]:OBW:TRIGger:SOURce?	881
[[:SENSe]:OBW:TRIGger:SOURce?	881
[[:SENSe]:PCONtrol:ADC:RANGe AUTO APEak APLOCK NONE M6 P0 P6 P12 P18 P24	883
[[:SENSe]:PCONtrol:ADC:RANGe?	883
[[:SENSe]:PCONtrol:BANDwidth BWIDth[:RESolution] <freq>	885
[[:SENSe]:PCONtrol:BANDwidth BWIDth[:RESolution]:TYPE FLATtop GAUSSian	886
[[:SENSe]:PCONtrol:BANDwidth BWIDth[:RESolution]:TYPE?	886
[[:SENSe]:PCONtrol:BANDwidth BWIDth[:RESolution]?	885
[[:SENSe]:PCONtrol:CAPTure:TIME <numeric>	887
[[:SENSe]:PCONtrol:CAPTure:TIME?	887
[[:SENSe]:PCONtrol:CRATe <freq>	888
[[:SENSe]:PCONtrol:CRATe?	888
[[:SENSe]:PCONtrol:FILTer[:RRC]:ALPHa <numeric>	888
[[:SENSe]:PCONtrol:FILTer[:RRC]:ALPHa?	888
[[:SENSe]:PCONtrol:FILTer[:RRC][:STATe] OFF ON 0 1	889
[[:SENSe]:PCONtrol:FILTer[:RRC][:STATe]?	889
[[:SENSe]:PCONtrol:METHod WAVEform CPOWER	889

List of Commands

[:SENSe]:PCONtrol:MEtHod?	.889
[:SENSe]:PCONtrol:PRACH:NFLoor <power>	.890
[:SENSe]:PCONtrol:PRACH:NFLoor?	.890
[:SENSe]:PCONtrol:PRACH:SIGNature <integer>	.891
[:SENSe]:PCONtrol:PRACH:SIGNature:AUTO OFF ON 0 1	.891
[:SENSe]:PCONtrol:PRACH:SIGNature:AUTO?	.891
[:SENSe]:PCONtrol:PRACH:SIGNature?	.891
[:SENSe]:PCONtrol:SBOundary:LIST:MS:APPend <symbol_rate>, <code_num>, IPH QPH	.892
[:SENSe]:PCONtrol:SBOundary:LIST:MS:INIT <symbol_rate>, <code_num>, IPH QPH	.892
[:SENSe]:PCONtrol:SBOundary:LIST:MS:NCHannels?	.895
[:SENSe]:PCONtrol:SBOundary:LIST:MS:REPLace <entry_id>, <symbol_rate>, <code_num>, IPH QPH	.892
[:SENSe]:PCONtrol:SBOundary:MS AUTO CUSTom	.896
[:SENSe]:PCONtrol:SBOundary:MS?	.896
[:SENSe]:PCONtrol:SLOT:FORMat SF0 SF1 SF2 SF3 SF4 SF5 AUTO	.897
[:SENSe]:PCONtrol:SLOT:FORMat?	.897
[:SENSe]:PCONtrol:SSLot:NUMBer <integer>	.898
[:SENSe]:PCONtrol:SSLot:NUMBer?	.898
[:SENSe]:PCONtrol:SSLot[:STATe] OFF ON 0 1	.898
[:SENSe]:PCONtrol:SSLot[:STATe]?	.898
[:SENSe]:PCONtrol:SYNC:SCRamble <integer>	.899
[:SENSe]:PCONtrol:SYNC:SCRamble?	.899
[:SENSe]:PCONtrol:TRIGger:SOURce EXtErnal[1] EXtErnal2 FRAMe IF IMMediate RFBurst LINE	.900
[:SENSe]:PCONtrol:TRIGger:SOURce?	.900
[:SENSe]:PCONtrol:TYPE SPOWer SLOT PRACH SPHase	.901
[:SENSe]:PCONtrol:TYPE?	.901
[:SENSe]:POWer:IQ:RANGe[:UPPer] <Float 64>[DBM] DBMV W	.902
[:SENSe]:POWer:IQ:RANGe[:UPPer] <power> [DBM] DBMV W	.786
[:SENSe]:POWer:IQ:RANGe[:UPPer]?	.786
[:SENSe]:POWer:IQ:RANGe[:UPPer]?	.902
[:SENSe]:POWer[:RF]:ATTenuation <rel_power>	.904

List of Commands

[[:SENSe]:POWer[:RF]:ATTenuation?	904
[[:SENSe]:POWer[:RF]:GAIN:ATTenuation <rel_power>	905
[[:SENSe]:POWer[:RF]:GAIN:ATTenuation?	905
[[:SENSe]:POWer[:RF]:GAIN[:STATe] OFF ON 0 1	904
[[:SENSe]:POWer[:RF]:GAIN[:STATe]?	904
[[:SENSe]:POWer[:RF]:RANGe:AUTO OFF ON 0 1	906
[[:SENSe]:POWer[:RF]:RANGe:AUTO?	906
[[:SENSe]:POWer[:RF]:RANGe[:UPPer] <power>	907
[[:SENSe]:POWer[:RF]:RANGe[:UPPer]?	907
[[:SENSe]:PStatistic: BANDwidth BWIDth <freq>	908
[[:SENSe]:PStatistic: BANDwidth BWIDth?	908
[[:SENSe]:PStatistic: COUNts <integer>	908
[[:SENSe]:PStatistic: COUNts?	908
[[:SENSe]:PStatistic: SWEep: TIME <time>	909
[[:SENSe]:PStatistic: SWEep: TIME?	909
[[:SENSe]:PStatistic: TRIGger: SOURce EXTernal[1] EXTernal2 FRAME IF IMMEDIATE RFBurst.	909
[[:SENSe]:PStatistic: TRIGger: SOURce?	909
[[:SENSe]:PVTime: AVERage: COUNT <integer>	910
[[:SENSe]:PVTime: AVERage: COUNT?	910
[[:SENSe]:PVTime: AVERage: TCONtrol EXPonential REPeat	911
[[:SENSe]:PVTime: AVERage: TCONtrol?	911
[[:SENSe]:PVTime: AVERage: TYPE LOG MAXimum MINimum MXMinimum RMS	911
[[:SENSe]:PVTime: AVERage: TYPE LOG MAXimum MINimum MXMinimum RMS POWer	911
[[:SENSe]:PVTime: AVERage: TYPE LOG MAXimum MINimum RMS SCALar	911
[[:SENSe]:PVTime: AVERage: TYPE RMS MAXimum MINimum	911
[[:SENSe]:PVTime: AVERage: TYPE?	911
[[:SENSe]:PVTime: AVERage[:STATe] OFF ON 0 1	910
[[:SENSe]:PVTime: AVERage[:STATe]?	910
[[:SENSe]:PVTime: BANDwidth BWIDth[:RESolution] <freq>	913
[[:SENSe]:PVTime: BANDwidth BWIDth[:RESolution]: TYPE FLATtop GAUSSian	914

List of Commands

[[:SENSe]:PVTime:BAWdwidth BWIDth[:RESolution]:TYPE?914
[[:SENSe]:PVTime:BAWdwidth BWIDth[:RESolution]?913
[[:SENSe]:PVTime:BURSt:STHReshold <rel_power>915
[[:SENSe]:PVTime:BURSt:STHReshold?915
[[:SENSe]:PVTime:CRATe <freq>915
[[:SENSe]:PVTime:CRATe?915
[[:SENSe]:PVTime:FILTer[:RRC]:ALPHa <numeric>915
[[:SENSe]:PVTime:FILTer[:RRC]:ALPHa?915
[[:SENSe]:PVTime:FILTer[:RRC][:STATe] 0 1 OFF ON916
[[:SENSe]:PVTime:FILTer[:RRC][:STATe]?916
[[:SENSe]:PVTime:LIMit:MASK OFF ON 0 1916
[[:SENSe]:PVTime:LIMit:MASK?916
[[:SENSe]:PVTime:MASK:LIST:LOWer:RELative <rel_power>, <rel_power>, <rel_power>, <rel_power>, <rel_power>916
[[:SENSe]:PVTime:MASK:LIST:LOWer:RELative?916
[[:SENSe]:PVTime:MASK:LIST:LOWer:TEST RELative NONE, ,RELative NONE, RELative NONE, RELative NONE, RELative NONE917
[[:SENSe]:PVTime:MASK:LIST:LOWer:TEST?917
[[:SENSe]:PVTime:MASK:LIST:PREFereNce A B C D E917
[[:SENSe]:PVTime:MASK:LIST:PREFereNce?917
[[:SENSe]:PVTime:MASK:LIST:SWEEp:TIME <seconds>{, <seconds>}918
[[:SENSe]:PVTime:MASK:LIST:SWEEp:TIME?918
[[:SENSe]:PVTime:MASK:LIST:TIME <seconds>{, <seconds>}918
[[:SENSe]:PVTime:MASK:LIST:TIME?918
[[:SENSe]:PVTime:MASK:LIST:UPPer:RELative <rel_power>, <rel_power>, <rel_power>, <rel_power>, <rel_power>918
[[:SENSe]:PVTime:MASK:LIST:UPPer:RELative?918
[[:SENSe]:PVTime:MASK:LIST:UPPer:TEST RELative NONE, RELative NONE, RELative NONE, RELative NONE, RELative NONE920
[[:SENSe]:PVTime:MASK:LIST:UPPer:TEST?920
[[:SENSe]:PVTime:MASK:REFereNce TRIGger RISE CENTER921
[[:SENSe]:PVTime:MASK:REFereNce?921

List of Commands

[[:SENSe]:PVTime:MASK:REFerence[:OFFSet]:TIME <time>	921
[[:SENSe]:PVTime:MASK:REFerence[:OFFSet]:TIME?	921
[[:SENSe]:PVTime:TRIGger:SOURce EXTernal[1] EXTernal2 FRAMe LINE IF IMMEDIATE RFBurst	922
[[:SENSe]:PVTime:TRIGger:SOURce?	922
[[:SENSe]:RADio:CONFigure:HSDPa[:STATe] OFF ON 0 1	923
[[:SENSe]:RADio:CONFigure:HSDPa[:STATe]?	923
[[:SENSe]:RADio:DEVICE BTS MS	924
[[:SENSe]:RADio:DEVICE?	924
[[:SENSe]:RHO:ADC:RANGe AUTO APEak APLOCK NONE M6 P0 P6 P12 P18 P24	925
[[:SENSe]:RHO:ADC:RANGe AUTO APEak APLOCK NONE P0 P6 P12 P18	925
[[:SENSe]:RHO:ADC:RANGe?	925
[[:SENSe]:RHO:ALPHa <numeric>	927
[[:SENSe]:RHO:ALPHa?	927
[[:SENSe]:RHO:AVERAge:COUNT <integer>	928
[[:SENSe]:RHO:AVERAge:COUNT?	928
[[:SENSe]:RHO:AVERAge:TCONtrol EXPonential REPEAT	929
[[:SENSe]:RHO:AVERAge:TCONtrol?	929
[[:SENSe]:RHO:AVERAge[:STATe] OFF ON 0 1	928
[[:SENSe]:RHO:AVERAge[:STATe]?	928
[[:SENSe]:RHO:CAPTure:TIME <time>	929
[[:SENSe]:RHO:CAPTure:TIME?	929
[[:SENSe]:RHO:CRATe <freq>	930
[[:SENSe]:RHO:CRATe?	930
[[:SENSe]:RHO:FERRor:TRANge WIDE NORMAl	930
[[:SENSe]:RHO:FERRor:TRANge?	930
[[:SENSe]:RHO:MCEStimator OFF ON 0 1	931
[[:SENSe]:RHO:MCEStimator:TIMing CHANnel GLOBAl	933
[[:SENSe]:RHO:MCEStimator:TIMing?	933
[[:SENSe]:RHO:MCEStimator?	931
[[:SENSe]:RHO:MICH:SPRead <integer>	932

List of Commands

[:SENSe]:RHO:MICH:SPRead?932
[:SENSe]:RHO:MICH:STATe OFF ON 0 1932
[:SENSe]:RHO:MICH:STATe?932
[:SENSe]:RHO:PICH:SPRead <integer>934
[:SENSe]:RHO:PICH:SPRead?934
[:SENSe]:RHO:PRACH:SIGNature <integer>935
[:SENSe]:RHO:PRACH:SIGNature <integer>964
[:SENSe]:RHO:PRACH:SIGNature:AUTO OFF ON 0 1964
[:SENSe]:RHO:PRACH:SIGNature:AUTO?964
[:SENSe]:RHO:PRACH:SIGNature?935
[:SENSe]:RHO:PRACH:SIGNature?964
[:SENSe]:RHO:SBOundary:LIST:MS INIT APPend <entry_id>, <symbol_rate>, <code_num>, IPH QPH936
[:SENSe]:RHO:SBOundary:LIST:MS:NCHannels?940
[:SENSe]:RHO:SBOundary:LIST:MS:REPLace <entry_id>, <symbol_rate>, <code_num>, IPH QPH952
[:SENSe]:RHO:SBOundary:LIST:MS? <entry_id>936
[:SENSe]:RHO:SBOundary:LIST[:BTS]:APPend <symbol_rate>, <code_num>, QPSK QAM16943
[:SENSe]:RHO:SBOundary:LIST[:BTS]:INIT <symbol_rate>,<code_num>, QPSK QAM16943
[:SENSe]:RHO:SBOundary:LIST[:BTS]:PRESet TM1D16 TM1D32 TM1D64 TM1D16SC TM1D32SC TM1D64SC TM2 TM2SC TM3D16 TM3D32 TM3D16SC TM3D32SC TM4 TM4CP TM5H2 TM5H4 TM5H8947
[:SENSe]:RHO:SBOundary:LIST[:BTS]:REPLace <entry_id>, <symbol_rate>, <code_num>, QPSK QAM16943
[:SENSe]:RHO:SBOundary:MS AUTO CUSTom948
[:SENSe]:RHO:SBOundary:MS?948
[:SENSe]:RHO:SBOundary?958
[:SENSe]:RHO:SBOundary[:BTS] AUTO TM1D16 TM1D32 TM1D64 TM1D16SC TM1D32SC TM1D64SC TM2 TM2SC TM3D16 TM3D32 TM3D16SC TM3D32SC TM4 TM4CP TM5H2 TM5H4 TM5H8 CUSTom941
[:SENSe]:RHO:SBOundary[:BTS] AUTO TM1D16 TM1D32 TM1D64 TM2 TM3D16 TM3D32 TM4 TM4CP TM1D16SC TM1D32SC TM1D64SC TM2SC TM3D16SC TM3D32SC TM5H2 TM5H4 TM5H8958

List of Commands

[[:SENSe]:RHO:SBOundary[:BTS]?	941
[[:SENSe]:RHO:SFORmat:MS SF0 SF1 SF2 SF3 SF4 SF5 AUTO	965
[[:SENSe]:RHO:SPECtrum INVert NORMal	968
[[:SENSe]:RHO:SPECtrum?	968
[[:SENSe]:RHO:SSLot:NUMBer <integer>	967
[[:SENSe]:RHO:SSLot:NUMBer?	967
[[:SENSe]:RHO:SSLot[:STATe] OFF ON 0 1.	967
[[:SENSe]:RHO:SSLot[:STATe]?	967
[[:SENSe]:RHO:SWEep:TIME:TRANsient INCLude EXCLude	969
[[:SENSe]:RHO:SWEep:TIME:TRANsient?	969
[[:SENSe]:RHO:SYNC:MS DPCCh PMESage.	970
[[:SENSe]:RHO:SYNC:MS?	970
[[:SENSe]:RHO:SYNC:SCRamble:MS <integer>.	973
[[:SENSe]:RHO:SYNC:SCRamble:MS?.	973
[[:SENSe]:RHO:SYNC:SCRamble[:BTS] <integer>.	971
[[:SENSe]:RHO:SYNC:SCRamble[:BTS]:OFFSet <integer>.	971
[[:SENSe]:RHO:SYNC:SCRamble[:BTS]:OFFSet?	971
[[:SENSe]:RHO:SYNC:SCRamble[:BTS]:TYPE LEFT RIGHT STANdard	972
[[:SENSe]:RHO:SYNC:SCRamble[:BTS]:TYPE?	972
[[:SENSe]:RHO:SYNC:SCRamble[:BTS]?	971
[[:SENSe]:RHO:SYNC:SYMBOL:SPRead <integer>	974
[[:SENSe]:RHO:SYNC:SYMBOL:SPRead?	974
[[:SENSe]:RHO:SYNC:SYMBOL:SRATe <integer>	975
[[:SENSe]:RHO:SYNC:SYMBOL:SRATe?	975
[[:SENSe]:RHO:SYNC[:BTS] CPICH SCH SYMBOL STTD A2CPich A1Sch A2Sch	969
[[:SENSe]:RHO:SYNC[:BTS]?	969
[[:SENSe]:RHO:TRIGger:SOURce IMMEDIATE IF EXTernal[1] EXTernal2 RFBurst FRAME	976
[[:SENSe]:RHO:TRIGger:SOURce?	976
[[:SENSe]:ROSCillator:EXTernal:FREQuency <frequency>.	977
[[:SENSe]:ROSCillator:EXTernal:FREQuency?	977

List of Commands

[:SENSe]:ROSCillator:OUTPut?	.978
[:SENSe]:ROSCillator:OUTPut[:STATe] OFF ON 0 1	.978
[:SENSe]:ROSCillator:SOURce INTernal EXTernal	.978
[:SENSe]:ROSCillator:SOURce?	.978
[:SENSe]:SEMAsk:AVERAge:COUNT <integer>	.979
[:SENSe]:SEMAsk:AVERAge:COUNT?	.979
[:SENSe]:SEMAsk:AVERAge[:STATe] OFF ON 0 1	.979
[:SENSe]:SEMAsk:AVERAge[:STATe]?	.979
[:SENSe]:SEMAsk:BANDwidth[n] BWIDth[n]:INTegration <freq>	.980
[:SENSe]:SEMAsk:BANDwidth[n] BWIDth[n]:INTegration?	.980
[:SENSe]:SEMAsk:BANDwidth[n] BWIDth[n]:RESolution <freq>	.981
[:SENSe]:SEMAsk:BANDwidth[n] BWIDth[n]:RESolution:AUTO OFF ON 0 1	.982
[:SENSe]:SEMAsk:BANDwidth[n] BWIDth[n]:RESolution:AUTO?	.982
[:SENSe]:SEMAsk:BANDwidth[n] BWIDth[n]:RESolution?	.981
[:SENSe]:SEMAsk:BANDwidth BWIDth:INTegration[m] <freq>	.980
[:SENSe]:SEMAsk:BANDwidth BWIDth:INTegration[m]?	.980
[:SENSe]:SEMAsk:BANDwidth BWIDth:RESolution[m] <freq>	.981
[:SENSe]:SEMAsk:BANDwidth BWIDth:RESolution[m]:AUTO OFF ON 0 1	.982
[:SENSe]:SEMAsk:BANDwidth BWIDth:RESolution[m]:AUTO?	.982
[:SENSe]:SEMAsk:BANDwidth BWIDth:RESolution[m]?	.981
[:SENSe]:SEMAsk:DETEctor[:FUNction] AAVerage POSitive	.983
[:SENSe]:SEMAsk:DETEctor[:FUNction]?	.983
[:SENSe]:SEMAsk:FILTer[:RRC]:ALPHA <numeric>	.983
[:SENSe]:SEMAsk:FILTer[:RRC]:ALPHA?	.983
[:SENSe]:SEMAsk:FILTer[:RRC][:STATe] OFF ON 0 1	.984
[:SENSe]:SEMAsk:FILTer[:RRC][:STATe]?	.984
[:SENSe]:SEMAsk:FREQuency:STEP[m] <freq>	.985
[:SENSe]:SEMAsk:FREQuency:STEP[m]:AUTO OFF ON 0 1	.986
[:SENSe]:SEMAsk:FREQuency:STEP[m]:AUTO?	.986
[:SENSe]:SEMAsk:FREQuency:STEP[m]?	.985
[:SENSe]:SEMAsk:FREQuency[n]:SPAN[m] <freq>	.984

List of Commands

[[:SENSe]:SEMAsk:FREQuency[n]:SPAN[m]?	984
[[:SENSe]:SEMAsk:FREQuency[n]:STEP <freq>.	985
[[:SENSe]:SEMAsk:FREQuency[n]:STEP:AUTO OFF ON 0 1	986
[[:SENSe]:SEMAsk:FREQuency[n]:STEP:AUTO?	986
[[:SENSe]:SEMAsk:FREQuency[n]:STEP?	985
[[:SENSe]:SEMAsk:OFFSet:LIST[m]:BANDwidth BWIDth <res_bw>,<res_bw>,<res_bw>,<res_bw>,<res_bw>	987
[[:SENSe]:SEMAsk:OFFSet:LIST[m]:BANDwidth BWIDth:AUTO OFF ON 0 1,OFF ON 0 1,OFF ON 0 1,OFF ON 0 1,OFF ON 0 1	988
[[:SENSe]:SEMAsk:OFFSet:LIST[m]:BANDwidth BWIDth:AUTO?	988
[[:SENSe]:SEMAsk:OFFSet:LIST[m]:BANDwidth BWIDth:IMULti <integer>,<integer>,<integer>,<integer>,<integer>	989
[[:SENSe]:SEMAsk:OFFSet:LIST[m]:BANDwidth BWIDth:IMULti?	989
[[:SENSe]:SEMAsk:OFFSet:LIST[m]:BANDwidth BWIDth?	987
[[:SENSe]:SEMAsk:OFFSet:LIST[m]:FREQuency:STARt <f_offset>,<f_offset>,<f_offset>,<f_offset>,<f_offset>	990
[[:SENSe]:SEMAsk:OFFSet:LIST[m]:FREQuency:STARt?	990
[[:SENSe]:SEMAsk:OFFSet:LIST[m]:FREQuency:STEP <f_offset>,<f_offset>,<f_offset>,<f_offset>,<f_offset>	991
[[:SENSe]:SEMAsk:OFFSet:LIST[m]:FREQuency:STEP:AUTO OFF ON 0 1,OFF ON 0 1,OFF ON 0 1,OFF ON 0 1,OFF ON 0 1	992
[[:SENSe]:SEMAsk:OFFSet:LIST[m]:FREQuency:STEP:AUTO?	992
[[:SENSe]:SEMAsk:OFFSet:LIST[m]:FREQuency:STEP?	991
[[:SENSe]:SEMAsk:OFFSet:LIST[m]:FREQuency:STOP <f_offset>,<f_offset>,<f_offset>,<f_offset>,<f_offset>	993
[[:SENSe]:SEMAsk:OFFSet:LIST[m]:FREQuency:STOP?	993
[[:SENSe]:SEMAsk:OFFSet:LIST[m]:RATTenuation <rel_power>,<rel_power>,<rel_power>,<rel_power>,<rel_power>	994
[[:SENSe]:SEMAsk:OFFSet:LIST[m]:RATTenuation?	994
[[:SENSe]:SEMAsk:OFFSet:LIST[m]:SIDE BOTH NEGative POSitive, BOTH NEGative POSitive,BOTH NEGative POSitive, BOTH NEGative POSitive,BOTH NEGative POSitive	995
[[:SENSe]:SEMAsk:OFFSet:LIST[m]:SIDE?	995
[[:SENSe]:SEMAsk:OFFSet:LIST[m]:STARt:ABSolute <abs_power>,<abs_power>,<abs_power>,<abs_power>,<abs_power>	996

List of Commands

[[:SENSE]:SEMAsk:OFFSet:LIST[m]:STARt:ABSolute?996
[[:SENSE]:SEMAsk:OFFSet:LIST[m]:STARt:RCARrier <rel_power>,<rel_power>,<rel_power>,<rel_power>,<rel_power>998
[[:SENSE]:SEMAsk:OFFSet:LIST[m]:STARt:RCARrier?998
[[:SENSE]:SEMAsk:OFFSet:LIST[m]:STATe OFF ON 0 1,OFF ON 0 1,OFF ON 0 1,OFF ON 0 1,OFF ON 0 1999
[[:SENSE]:SEMAsk:OFFSet:LIST[m]:STATe?999
[[:SENSE]:SEMAsk:OFFSet:LIST[m]:STOP:ABSolute <abs_power>,<abs_power>,<abs_power>,<abs_power>,<abs_power>	1000
[[:SENSE]:SEMAsk:OFFSet:LIST[m]:STOP:ABSolute:COUPle OFF ON 0 1,OFF ON 0 1,OFF ON 0 1,OFF ON 0 1,OFF ON 0 1	1002
[[:SENSE]:SEMAsk:OFFSet:LIST[m]:STOP:ABSolute:COUPle?	1002
[[:SENSE]:SEMAsk:OFFSet:LIST[m]:STOP:ABSolute?	1000
[[:SENSE]:SEMAsk:OFFSet:LIST[m]:STOP:RCARrier <rel_power>,<rel_power>,<rel_power>,<rel_power>,<rel_power>	1003
[[:SENSE]:SEMAsk:OFFSet:LIST[m]:STOP:RCARrier:COUPle OFF ON 0 1,OFF ON 0 1,OFF ON 0 1,OFF ON 0 1,OFF ON 0 1	1004
[[:SENSE]:SEMAsk:OFFSet:LIST[m]:STOP:RCARrier:COUPle?	1004
[[:SENSE]:SEMAsk:OFFSet:LIST[m]:STOP:RCARrier?	1003
[[:SENSE]:SEMAsk:OFFSet:LIST[m]:TEST ABSolute AND OR RELative,ABSolute AND OR RELative, ABSolute AND OR RELative,ABSolute AND OR RELative, ABSolute AND OR RELative.	1005
[[:SENSE]:SEMAsk:OFFSet:LIST[m]:TEST?	1005
[[:SENSE]:SEMAsk:OFFSet[n]:LIST:BANDwidth BWIDth <res_bw>,<res_bw>,<res_bw>,<res_bw>,<res_bw>987
[[:SENSE]:SEMAsk:OFFSet[n]:LIST:BANDwidth BWIDth:AUTO OFF ON 0 1,OFF ON 0 1,OFF ON 0 1,OFF ON 0 1,OFF ON 0 1988
[[:SENSE]:SEMAsk:OFFSet[n]:LIST:BANDwidth BWIDth:AUTO?988
[[:SENSE]:SEMAsk:OFFSet[n]:LIST:BANDwidth BWIDth:IMULti <integer>,<integer>,<integer>,<integer>,<integer>989
[[:SENSE]:SEMAsk:OFFSet[n]:LIST:BANDwidth BWIDth:IMULti?989
[[:SENSE]:SEMAsk:OFFSet[n]:LIST:BANDwidth BWIDth?987
[[:SENSE]:SEMAsk:OFFSet[n]:LIST:FREQuency:STARt <f_offset>,<f_offset>,<f_offset>,<f_offset>,<f_offset>990
[[:SENSE]:SEMAsk:OFFSet[n]:LIST:FREQuency:STARt?990

List of Commands

[[:SENSe]:SEMAsk:OFFSet[n]:LIST:FREQuency:STEP <f_offset>,<f_offset>,<f_offset>,<f_offset>,<f_offset>	991
[[:SENSe]:SEMAsk:OFFSet[n]:LIST:FREQuency:STEP:AUTO OFF ON 0 1,OFF ON 0 1,OFF ON 0 1,OFF ON 0 1,OFF ON 0 1	992
[[:SENSe]:SEMAsk:OFFSet[n]:LIST:FREQuency:STEP:AUTO?	992
[[:SENSe]:SEMAsk:OFFSet[n]:LIST:FREQuency:STEP?	991
[[:SENSe]:SEMAsk:OFFSet[n]:LIST:FREQuency:STOP <f_offset>,<f_offset>,<f_offset>,<f_offset>,<f_offset>	993
[[:SENSe]:SEMAsk:OFFSet[n]:LIST:FREQuency:STOP?	993
[[:SENSe]:SEMAsk:OFFSet[n]:LIST:RATTenuation <rel_power>,<rel_power>,<rel_power>,<rel_power>,<rel_power>	994
[[:SENSe]:SEMAsk:OFFSet[n]:LIST:RATTenuation?	994
[[:SENSe]:SEMAsk:OFFSet[n]:LIST:SIDE BOTH NEGative POSitive, BOTH NEGative POSitive,BOTH NEGative POSitive, BOTH NEGative POSitive,BOTH NEGative POSitive	995
[[:SENSe]:SEMAsk:OFFSet[n]:LIST:SIDE?	995
[[:SENSe]:SEMAsk:OFFSet[n]:LIST:STARt:ABSolute <abs_power>,<abs_power>,<abs_power>,<abs_power>,<abs_power>	996
[[:SENSe]:SEMAsk:OFFSet[n]:LIST:STARt:ABSolute?	996
[[:SENSe]:SEMAsk:OFFSet[n]:LIST:STARt:RCARrier <rel_power>,<rel_power>,<rel_power>,<rel_power>,<rel_power>	998
[[:SENSe]:SEMAsk:OFFSet[n]:LIST:STARt:RCARrier?	998
[[:SENSe]:SEMAsk:OFFSet[n]:LIST:STATe OFF ON 0 1,OFF ON 0 1,OFF ON 0 1,OFF ON 0 1,OFF ON 0 1	999
[[:SENSe]:SEMAsk:OFFSet[n]:LIST:STATe?	999
[[:SENSe]:SEMAsk:OFFSet[n]:LIST:STOP:ABSolute <abs_power>,<abs_power>,<abs_power>,<abs_power>,<abs_power>	1000
[[:SENSe]:SEMAsk:OFFSet[n]:LIST:STOP:ABSolute:COUple OFF ON 0 1,OFF ON 0 1,OFF ON 0 1,OFF ON 0 1,OFF ON 0 1	1002
[[:SENSe]:SEMAsk:OFFSet[n]:LIST:STOP:ABSolute:COUple?	1002
[[:SENSe]:SEMAsk:OFFSet[n]:LIST:STOP:ABSolute?	1000
[[:SENSe]:SEMAsk:OFFSet[n]:LIST:STOP:RCARrier <rel_power>,<rel_power>,<rel_power>,<rel_power>,<rel_power>	1003
[[:SENSe]:SEMAsk:OFFSet[n]:LIST:STOP:RCARrier:COUple OFF ON 0 1,OFF ON 0 1,OFF ON 0 1,OFF ON 0 1,OFF ON 0 1	1004
[[:SENSe]:SEMAsk:OFFSet[n]:LIST:STOP:RCARrier:COUple?	1004

List of Commands

[:SENSe]:SEMAsk:OFFSet[n]:LIST:STOP:RCARrier?	1003
[:SENSe]:SEMAsk:OFFSet[n]:LIST:TEST ABSolute AND OR RELative,ABSolute AND OR RELative, ABSolute AND OR RELative,ABSolute AND OR RELative, ABSolute AND OR RELative.	1005
[:SENSe]:SEMAsk:OFFSet[n]:LIST:TEST?	1005
[:SENSe]:SEMAsk:REGion:LIST:BANDwidth BWIDth <res_bw>,<res_bw>,<res_bw>,<res_bw>,<res_bw>	1006
[:SENSe]:SEMAsk:REGion:LIST:BANDwidth BWIDth:AUTO OFF ON 0 1,OFF ON 0 1,OFF ON 0 1,OFF ON 0 1,OFF ON 0 1	1007
[:SENSe]:SEMAsk:REGion:LIST:BANDwidth BWIDth:AUTO?	1007
[:SENSe]:SEMAsk:REGion:LIST:BANDwidth BWIDth?	1006
[:SENSe]:SEMAsk:REGion:LIST:FREQuency:STARt <f_region>,<f_region>,<f_region>,<f_region>,<f_region>	1008
[:SENSe]:SEMAsk:REGion:LIST:FREQuency:STARt?	1008
[:SENSe]:SEMAsk:REGion:LIST:FREQuency:STEP <f_region>,<f_region>,<f_region>,<f_region>,<f_region>	1009
[:SENSe]:SEMAsk:REGion:LIST:FREQuency:STEP:AUTO OFF ON 0 1,OFF ON 0 1,OFF ON 0 1,OFF ON 0 1,OFF ON 0 1	1010
[:SENSe]:SEMAsk:REGion:LIST:FREQuency:STEP:AUTO?	1010
[:SENSe]:SEMAsk:REGion:LIST:FREQuency:STEP?	1009
[:SENSe]:SEMAsk:REGion:LIST:FREQuency:STOP <f_region>,<f_region>,<f_region>,<f_region>,<f_region>	1011
[:SENSe]:SEMAsk:REGion:LIST:FREQuency:STOP?	1011
[:SENSe]:SEMAsk:REGion:LIST:RATTenuation <rel_power>,<rel_power>,<rel_power>,<rel_power>,<rel_power>	1012
[:SENSe]:SEMAsk:REGion:LIST:RATTenuation?	1012
[:SENSe]:SEMAsk:REGion:LIST:STARt:ABSolute <abs_power>,<abs_power>,<abs_power>,<abs_power>,<abs_power>	1013
[:SENSe]:SEMAsk:REGion:LIST:STARt:ABSolute?	1013
[:SENSe]:SEMAsk:REGion:LIST:STARt:RCARrier <rel_power>,<rel_power>,<rel_power>,<rel_power>,<rel_power>	1014
[:SENSe]:SEMAsk:REGion:LIST:STARt:RCARrier?	1014
[:SENSe]:SEMAsk:REGion:LIST:STATe OFF ON 0 1,OFF ON 0 1,OFF ON 0 1,OFF ON 0 1,OFF ON 0 1	1015
[:SENSe]:SEMAsk:REGion:LIST:STATe?	1015

List of Commands

[[:SENSe]:SEMAsk:REGion:LIST:STOP:ABSolute <abs_power>,<abs_power>,<abs_power>,<abs_power>,<abs_power>	1016
[[:SENSe]:SEMAsk:REGion:LIST:STOP:ABSolute?	1016
[[:SENSe]:SEMAsk:REGion:LIST:STOP:RCARrier <rel_power>,<rel_power>,<rel_power>,<rel_power>,<rel_power>	1018
[[:SENSe]:SEMAsk:REGion:LIST:STOP:RCARrier:COUPLE OFF ON 0 1,OFF ON 0 1,OFF ON 0 1,OFF ON 0 1,OFF ON 0 1	1019
[[:SENSe]:SEMAsk:REGion:LIST:STOP:RCARrier:COUPLE?	1019
[[:SENSe]:SEMAsk:REGion:LIST:STOP:RCARrier?	1018
[[:SENSe]:SEMAsk:REGion:LIST:TEST ABSolute AND OR RELative, ABSolute AND OR RELative,ABSolute AND OR RELative, ABSolute AND OR RELative,ABSolute AND OR RELative.	1020
[[:SENSe]:SEMAsk:REGion:LIST:TEST?	1020
[[:SENSe]:SEMAsk:REGion[n]:LIST:BANDwidth BWIDth <res_bw>,<res_bw>,<res_bw>,<res_bw>,<res_bw>	1006
[[:SENSe]:SEMAsk:REGion[n]:LIST:BANDwidth BWIDth:AUTO OFF ON 0 1,OFF ON 0 1,OFF ON 0 1,OFF ON 0 1,OFF ON 0 1	1007
[[:SENSe]:SEMAsk:REGion[n]:LIST:BANDwidth BWIDth:AUTO?	1007
[[:SENSe]:SEMAsk:REGion[n]:LIST:BANDwidth BWIDth?	1006
[[:SENSe]:SEMAsk:REGion[n]:LIST:FREQuency:START <f_region>,<f_region>,<f_region>,<f_region>,<f_region>	1008
[[:SENSe]:SEMAsk:REGion[n]:LIST:FREQuency:START?	1008
[[:SENSe]:SEMAsk:REGion[n]:LIST:FREQuency:STEP <f_region>,<f_region>,<f_region>,<f_region>,<f_region>	1009
[[:SENSe]:SEMAsk:REGion[n]:LIST:FREQuency:STEP:AUTO OFF ON 0 1,OFF ON 0 1,OFF ON 0 1,OFF ON 0 1,OFF ON 0 1	1010
[[:SENSe]:SEMAsk:REGion[n]:LIST:FREQuency:STEP:AUTO?	1010
[[:SENSe]:SEMAsk:REGion[n]:LIST:FREQuency:STEP?	1009
[[:SENSe]:SEMAsk:REGion[n]:LIST:FREQuency:STOP <f_region>,<f_region>,<f_region>,<f_region>,<f_region>	1011
[[:SENSe]:SEMAsk:REGion[n]:LIST:FREQuency:STOP?	1011
[[:SENSe]:SEMAsk:REGion[n]:LIST:RATTenuation <rel_power>,<rel_power>,<rel_power>,<rel_power>,<rel_power>	1012
[[:SENSe]:SEMAsk:REGion[n]:LIST:RATTenuation?	1012
[[:SENSe]:SEMAsk:REGion[n]:LIST:START:ABSolute <abs_power>,<abs_power>,<abs_power>,<abs_power>,<abs_power>	1013

List of Commands

[:SENSe]:SEMAsk:REGion[n]:LIST:STARt:ABSolute?	1013
[:SENSe]:SEMAsk:REGion[n]:LIST:STARt:RCARrier <rel_power>,<rel_power>,<rel_power>,<rel_power>,<rel_power>	1014
[:SENSe]:SEMAsk:REGion[n]:LIST:STARt:RCARrier?	1014
[:SENSe]:SEMAsk:REGion[n]:LIST:STATe OFF ON 0 1,OFF ON 0 1,OFF ON 0 1,OFF ON 0 1,OFF ON 0 1	1015
[:SENSe]:SEMAsk:REGion[n]:LIST:STATe?	1015
[:SENSe]:SEMAsk:REGion[n]:LIST:STOP:ABSolute <abs_power>,<abs_power>,<abs_power>,<abs_power>,<abs_power>	1016
[:SENSe]:SEMAsk:REGion[n]:LIST:STOP:ABSolute:COUple OFF ON 0 1,{OFF ON 0 1}	1017
[:SENSe]:SEMAsk:REGion[n]:LIST:STOP:ABSolute:COUple?	1017
[:SENSe]:SEMAsk:REGion[n]:LIST:STOP:ABSolute?	1016
[:SENSe]:SEMAsk:REGion[n]:LIST:STOP:RCARrier <rel_power>,<rel_power>,<rel_power>,<rel_power>,<rel_power>	1018
[:SENSe]:SEMAsk:REGion[n]:LIST:STOP:RCARrier:COUple OFF ON 0 1,OFF ON 0 1,OFF ON 0 1,OFF ON 0 1,OFF ON 0 1	1019
[:SENSe]:SEMAsk:REGion[n]:LIST:STOP:RCARrier:COUple?	1019
[:SENSe]:SEMAsk:REGion[n]:LIST:STOP:RCARrier?	1018
[:SENSe]:SEMAsk:REGion[n]:LIST:TEST ABSolute AND OR RELative, ABSolute AND OR RELative,ABSolute AND OR RELative, ABSolute AND OR RELative,ABSolute AND OR RELative	1020
[:SENSe]:SEMAsk:REGion[n]:LIST:TEST?	1020
[:SENSe]:SEMAsk:SEGment OFFSet REGion	1021
[:SENSe]:SEMAsk:SEGment?	1021
[:SENSe]:SEMAsk:SWEep:TIME <time> <no. of chips>	1021
[:SENSe]:SEMAsk:SWEep:TIME?	1021
[:SENSe]:SEMAsk:TRIGger:SOURce EXTernal[1] EXTernal2 FRAME IMMediate LINE	1022
[:SENSe]:SEMAsk:TRIGger:SOURce?	1022
[:SENSe]:SEMAsk:TYPE PSDRef TPRef	1022
[:SENSe]:SEMAsk:TYPE?	1022
[:SENSe]:SPECTrum:ACQuisition:PACKing AUTO LONG MEDIum SHORT	1023
[:SENSe]:SPECTrum:ACQuisition:PACKing?	1023
[:SENSe]:SPECTrum:ADC:DITHer[:STATe] AUTO ON OFF 2 1 0	1024

List of Commands

[[:SENSe]:SPECTrum:ADC:DITHer[:STATe]?	1024
[[:SENSe]:SPECTrum:ADC:RANGe AUTO APEak APLOCK M6 P0 P6 P12 P18 P24	1024
[[:SENSe]:SPECTrum:ADC:RANGe AUTO APEak APLOCK NONE P0 P6 P12 P18	1024
[[:SENSe]:SPECTrum:ADC:RANGe?	1024
[[:SENSe]:SPECTrum:AVERAge:CLEar	1026
[[:SENSe]:SPECTrum:AVERAge:COUNT <integer>	1026
[[:SENSe]:SPECTrum:AVERAge:COUNT?	1026
[[:SENSe]:SPECTrum:AVERAge:TCONtrol EXPONential REPeat	1027
[[:SENSe]:SPECTrum:AVERAge:TCONtrol?	1027
[[:SENSe]:SPECTrum:AVERAge:TYPE LOG MAXimum MINimum RMS SCALar	1027
[[:SENSe]:SPECTrum:AVERAge:TYPE?	1027
[[:SENSe]:SPECTrum:AVERAge[:STATe] OFF ON 0 1	1027
[[:SENSe]:SPECTrum:AVERAge[:STATe]?	1027
[[:SENSe]:SPECTrum:BANDwidth BWIDth:IF:AUTO OFF ON 0 1	1028
[[:SENSe]:SPECTrum:BANDwidth BWIDth:IF:AUTO?	1028
[[:SENSe]:SPECTrum:BANDwidth BWIDth:IF:FLATness OFF ON 0 1	1029
[[:SENSe]:SPECTrum:BANDwidth BWIDth:IF:FLATness?	1029
[[:SENSe]:SPECTrum:BANDwidth BWIDth:PADC OFF ON 0 1	1029
[[:SENSe]:SPECTrum:BANDwidth BWIDth:PADC?	1029
[[:SENSe]:SPECTrum:BANDwidth BWIDth:PFFT:TYPE FLAT GAUSSian	1031
[[:SENSe]:SPECTrum:BANDwidth BWIDth:PFFT:TYPE?	1031
[[:SENSe]:SPECTrum:BANDwidth BWIDth:PFFT[:SIZE] <freq>	1030
[[:SENSe]:SPECTrum:BANDwidth BWIDth:PFFT[:SIZE]?	1030
[[:SENSe]:SPECTrum:BANDwidth BWIDth[:RESolution] <freq>	1031
[[:SENSe]:SPECTrum:BANDwidth BWIDth[:RESolution]:AUTO OFF ON 0 1	1032
[[:SENSe]:SPECTrum:BANDwidth BWIDth[:RESolution]:AUTO?	1032
[[:SENSe]:SPECTrum:BANDwidth BWIDth[:RESolution]?	1031
[[:SENSe]:SPECTrum:DECimate[:FACTor] <integer>	1033
[[:SENSe]:SPECTrum:DECimate[:FACTor]?	1033
[[:SENSe]:SPECTrum:FFT:LENGth <integer>	1033
[[:SENSe]:SPECTrum:FFT:LENGth:AUTO OFF ON 0 1	1034

List of Commands

[:SENSe]:SPECTrum:FFT:LENGth:AUTO?	1034
[:SENSe]:SPECTrum:FFT:LENGth?	1033
[:SENSe]:SPECTrum:FFT:RBWPoints <real>	1035
[:SENSe]:SPECTrum:FFT:RBWPoints?	1035
[:SENSe]:SPECTrum:FFT:WINDow:DELay <real>	1035
[:SENSe]:SPECTrum:FFT:WINDow:DELay?	1035
[:SENSe]:SPECTrum:FFT:WINDow:LENGth <integer>	1036
[:SENSe]:SPECTrum:FFT:WINDow:LENGth?	1036
[:SENSe]:SPECTrum:FFT:WINDow[:TYPE] BH4Tap BLACKman FLATtop GAUSSian HAMMING HANNing KB70 KB90 KB110 UNIFORM	1036
[:SENSe]:SPECTrum:FFT:WINDow[:TYPE]?	1036
[:SENSe]:SPECTrum:FREQuency:SPAN <freq>	1037
[:SENSe]:SPECTrum:FREQuency:SPAN?	1037
[:SENSe]:SPECTrum:SWEep:TIME:AUTO OFF ON 0 1	1038
[:SENSe]:SPECTrum:SWEep:TIME:AUTO	1038
[:SENSe]:SPECTrum:SWEep:TIME?	1038
[:SENSe]:SPECTrum:SWEep:TIME[:VALue] <time>	1038
[:SENSe]:SPECTrum:TRIGger:SOURce EXTernal[1] EXTernal2 FRAME IF LINE IMMEDIATE RFBurst	1039
[:SENSe]:SPECTrum:TRIGger:SOURce?	1039
[:SENSe]:VOLTage:IQ:RANGe[:UPPer] <Float 64> [V]	903
[:SENSe]:VOLTage:IQ:RANGe[:UPPer] <level>	787
[:SENSe]:VOLTage:IQ:RANGe[:UPPer]?	787
[:SENSe]:VOLTage:IQ:RANGe[:UPPer]?	903
[:SENSe]:WAVEform:ACQuisition:PACKing AUTO LONG MEDium SHORt	1040
[:SENSe]:WAVEform:ACQuisition:PACKing?	1040
[:SENSe]:WAVEform:ADC:DITHer[:STATe] AUTO ON OFF 2 1 0	1041
[:SENSe]:WAVEform:ADC:DITHer[:STATe]?	1041
[:SENSe]:WAVEform:ADC:FILTer[:STATe] OFF ON 0 1	1041
[:SENSe]:WAVEform:ADC:FILTer[:STATe]?	1041
[:SENSe]:WAVEform:ADC:RANGe AUTO APEak APLock GROund M6 P0 P6 P12 P18 P24	1042

List of Commands

[[:SENSe]:WAVeform:ADC:RANGe?	1042
[[:SENSe]:WAVeform:ADC:RANGe AUTO APEak APLock GROund NONE P0 P6 P12 P18	1042
[[:SENSe]:WAVeform:APERture?	1043
[[:SENSe]:WAVeform:AVERage:COUNt <integer>	1043
[[:SENSe]:WAVeform:AVERage:COUNt?	1043
[[:SENSe]:WAVeform:AVERage:TCONtrol EXPonential REPeat	1044
[[:SENSe]:WAVeform:AVERage:TCONtrol?	1044
[[:SENSe]:WAVeform:AVERage:TYPE LOG MAXimum MINimum RMS SCALar	1045
[[:SENSe]:WAVeform:AVERage:TYPE?	1045
[[:SENSe]:WAVeform:AVERage[:STATe] OFF ON 0 1	1044
[[:SENSe]:WAVeform:AVERage[:STATe]?	1044
[[:SENSe]:WAVeform:BANDwidth[:RESolution]:ACTual?	1046
[[:SENSe]:WAVeform:BANDwidth BWIDth[:RESolution] <freq>	1045
[[:SENSe]:WAVeform:BANDwidth BWIDth[:RESolution]:TYPE FLATtop GAUSSian	1047
[[:SENSe]:WAVeform:BANDwidth BWIDth[:RESolution]:TYPE?	1047
[[:SENSe]:WAVeform:BANDwidth BWIDth[:RESolution]?	1045
[[:SENSe]:WAVeform:DECimate:STATe OFF ON 0 1	1048
[[:SENSe]:WAVeform:DECimate:STATe?	1048
[[:SENSe]:WAVeform:DECimate[:FACTor] <integer>	1047
[[:SENSe]:WAVeform:DECimate[:FACTor]?	1047
[[:SENSe]:WAVeform:SWEep:TIME <time>	1048
[[:SENSe]:WAVeform:SWEep:TIME?	1048
[[:SENSe]:WAVeform:TRIGger:SOURce EXTernal[1] EXTernal2 FRAMe IF IMMEDIATE LINE RFBurst	1049
[[:SENSe]:WAVeform:TRIGger:SOURce?	1049
CALCulate:CDPower:ASET:THReshold:AUTO OFF ON 0 1	562
CALCulate:CDPower:ASET:THReshold:AUTO?	562
CALCulate:CDPower:TDPCh <integer>	577
CALCulate:CDPower:TDPCh:AUTO OFF ON 0 1	577
CALCulate:CDPower:TDPCh:AUTO?	577
CALCulate:CDPower:TDPCh?	577

1 Introduction

This chapter provides overall information on W-CDMA, HSDPA and HSUPA communications systems, Options BAF and 210, and describes W-CDMA (3GPP) measurements made by the analyzer. Installation instructions for adding this option to your analyzer are provided in this section, in case you purchased this option separately.

What Do the Agilent PSA Series and VSA E4406A Options BAF and 210 Do?

This instrument can be used for testing a W-CDMA transmitter, including measuring HSDPA/HSUPA signals, manufactured according to the following standards documents:

- 3GPP TS 25.141 Base Station (BS) conformance testing (FDD) V6.10.0 (2005-06)
- 3GPP TS 25.211 Physical channels and mapping of transport channels onto physical channels (FDD) V6.5.0 (2005-06)
- 3GPP TS 25.212 Multiplexing and channel coding (FDD) V6.5.0 (2005-06)
- 3GPP TS 25.213 Spreading and modulation (FDD) V6.3.0 (2005-06)
- 3GPP TS 25.214 Physical layer procedure (FDD) V6.6.0 (2005-06)
- 3GPP TS 34.121 Terminal conformance specification; Radio transmission and reception (FDD) V6.1.0 (2005-06)

These documents define complex, multi-part measurements used to create and maintain an interference-free environment. For example, the documents include standardized test methods for the measurement of power in a carrier, a spectrum emission mask, intermodulation, and other critical measurements.

The instrument automatically makes these measurements using the measurement methods and limits defined in the documents. The detailed results displayed by the measurements allow you to analyze W-CDMA system performance. You may alter the measurement parameters for specialized analysis. For infrastructure test, the instrument will test transmitters of base stations in a non-interfering manner by means of a coupler or power splitter.

This instrument makes the following measurements of W-CDMA (3GPP) and HSDPA/HSUPA signals:

- Channel Power
- Adjacent Channel Leakage Power Ratio (ACPR or ACLR)
- Intermodulation Products
- Multi Carrier Power
- Spectrum Emission Mask
- Occupied Bandwidth
- Code Domain Power
- Modulation Accuracy (Composite EVM)
- QPSK EVM
- Power Statistics CCDF
- Spectrum (Freq Domain)
- Waveform (Time Domain)
- Power Control (Up Link)
- Power versus Time Mask

For more information on individual measurements see [Chapter 2](#) , “Making Measurements,” on page 67.

Installing Optional Measurement Personalities

When you install a measurement personality, you need to follow a three step process:

1. Determine whether your memory capacity is sufficient to contain all the options you want to load. If not, decide which options you want to install now, and consider upgrading your memory. Details follow in [“Do You Have Enough Memory to Load All Your Personality Options?”](#) on page 56.
2. Install the measurement personality firmware into the instrument memory. Details follow in [“Loading an Optional Measurement Personality”](#) on page 61.
3. Enter a license key that activates the measurement personality. Details follow in [“Obtaining and Installing a License Key”](#) on page 61.

Adding measurement personalities requires the purchase of an upgrade kit for the desired option. The upgrade kit contains the measurement personality firmware and an entitlement certificate that is used to generate a license key from the internet website. A separate license key is required for each option on a specific instrument serial number and host ID.

For the latest information on Agilent Spectrum Analyzer options and upgrade kits, visit the following Internet URL:

http://www.agilent.com/find/sa_upgrades

Do You Have Enough Memory to Load All Your Personality Options?

If you do not have memory limitations then you can skip ahead to the next section [“Loading an Optional Measurement Personality”](#) on page 61. If after installing your options you get error messages relating to memory issues, you can return to this section to learn more about how to optimize your configuration.

If you have 64 MBytes of memory installed in your instrument, you should have enough memory to install at least four optional personalities, with plenty of memory for data and states.

The optional measurement personalities require different amounts of memory. So the number of personalities that you can load varies. This is also impacted by how much data you need to save. If you are having memory errors you must swap the applications in/out of memory as needed. If you only have 48 MBytes of memory, you can upgrade your

hardware to 64 MBytes.

Additional memory can be added to any PSA Series analyzer by installing Option 115. With this option installed, you can install all currently available measurement personalities in your analyzer and still have memory space to store more state and trace files than would otherwise be possible.

To see the size of your installed memory for PSA Series Spectrum Analyzers:

1. Ensure that the spectrum analyzer is in spectrum analyzer mode because this can affect the screen size.
2. Press **System, More, Show Hdwr.**
3. Read Flash Memory size in the table. If Option 115 is installed (PSA only), the table will also show Compact Flash Type and Compact Flash Size.

PSA Flash Memory Size	Available Memory Without Option B7J and Option 122 or 140	Available Memory With Option B7J and Option 122 or 140
64 Mbytes	32.5 MBytes	30.0 MBytes
48 Mbytes	16.9 MBytes	14.3 MBytes

PSA Compact Flash Memory Size	Available Additional Memory for Measurement Personalities
512 Mbytes (Opt. 115)	512 MBytes

To see the size of your installed memory for E4406A Transmitter Testers:

1. Press the **System** key, **MORE (1 of 3)**, and **MORE (2 of 3)** keys.
2. Read the **File System Key** - The total of the entries for **Used** and **Free** memory will total the installed flash memory, either 48 or 64 MBytes.

If you have 48 MBytes of memory, and you want to install more than 3 optional personalities, you may need to manage your memory resources. The following section, [“How to Predict Your Memory Requirements” on page 58](#), will help you decide how to configure your installed options to provide optimal operation.

How to Predict Your Memory Requirements

NOTE If you have a PSA Series analyzer with Option 115, there is adequate memory to install all of the available optional personalities in your instrument.

If you plan to install many optional personalities, you should review your memory requirements, so you can determine whether you have enough memory (unless you have a PSA Series with Option 115). There is an Agilent “Memory Calculator” available online that can help you do this, or you can make a calculated approximation using the information that follows. You will need to know your instrument’s installed memory size as determined in the previous section and then select your desired applications.

For E4406A see: http://www.agilent.com/find/e4406a_firmware

For PSA Series see: http://www.agilent.com/find/psa_firmware

Select the “Memory Calculator” link. You can try any combination of available personalities to see if your desired configuration is compatible with your installed memory.

NOTE For PSA: After loading all your optional measurement personalities, you should have a reserve of ~2 MBytes memory to facilitate mode switching. Less available memory will increase mode switching time. For example, if you employ excessive free memory by saving files of states and/or data, your mode switching time can increase to more than a minute.

You can manually estimate your total memory requirements by adding up the memory allocations described in the following steps. Compare the desired total with the available memory that you identified in the previous section.

1. Program memory - Select option requirements from the table “Measurement Personality Options and Memory Required” on page 59.
2. For PSA only: shared libraries require 7.72 MBytes
3. For PSA only: recommended mode swap space is 2 MBytes
4. Screens - .gif files need 20-25 kB each
5. State memory - State file sizes range from 21 kB for SA mode to 40 kB for W-CDMA. The state of every mode accessed since power-on will be saved in the state file. File sizes can exceed 150 kB each when several modes are accessed, for each state file saved.

TIP State memory retains settings for all states accessed before the **Save State** command. To reduce this usage to a minimum, reduce the modes accessed before the **Save State** is executed. You can set the PSA to boot into a selected mode by assessing the desired mode, then pressing the **System, Power On/Preset, Power On** keys and toggle the setting to **Last**.

Measurement Personality Options and Memory Required

Personality Options for PSA Series Spectrum Analyzers ^a	Option	File Size (PSA Rev: A.09)
cdmaOne measurement personality	BAC	1.91 Mbytes
NADC and PDC measurement personalities (not available separately)	BAE	2.43 Mbytes
W-CDMA or W-CDMA , HSDPA, HSUPA measurement personality	BAF, 210	5.38 Mbytes ^b
cdma2000 or cdma2000 w/ 1xEV-DV measurement personality	B78, 214	4.00 Mbytes ^b
1xEV-DO measurement personality	204	5.61 Mbytes ^b
GSM (with EDGE) measurement personality	202	3.56 Mbytes ^b
Shared measurement library ^b	n/a	7.72 Mbytes
Phase Noise measurement personality	226	2.82 Mbytes ^c
Noise Figure measurement personality	219	4.68 Mbytes ^c
Basic measurement personality with digital demod hardware	B7J	Cannot be deleted (2.64 Mbytes)
Programming Code Compatibility Suite ^d (8560 Series, 8590 Series, and 8566B/8568B)	266	1.18 Mbytes ^c
TD-SCDMA	211	5.47 Mbytes ^c
Flexible Digital Modulation Analysis	241	2.11 Mbytes ^b
WLAN measurement personality	217	3.24 Mbytes ^b
External Source Control	215	0.72 Mbytes ^c
Measuring Receiver Personality	233	2.91 Mbytes ^b

a. Available as of the print date of this guide.

- b. Many PSA Series personality options use a 7.72 Mbyte shared measurement library. If you are loading multiple personalities that use this library, you only need to add this memory allocation once.
- c. Shared measurement library allocation not required.
- d. This is a no charge option that does not require a license key.

Personality Options for E4406A Transmitter Tester ^a	Option	File Size (E4406A Rev: A.10)
cdmaOne measurement personality	BAC	1.82 Mbytes
NADC measurement personality	BAE	1.10 Mbytes
PDC measurement personality	BAE	1.23 Mbytes
W-CDMA or W-CDMA, HSDPA, HSUPA measurement personality	BAF, 210	5.00 Mbytes
cdma2000 or cdma2000 w/ 1xEV-DV measurement personality	B78, 214	3.88 Mbytes
1xEV-DO measurement personality	204	4.84 Mbytes
GSM (with EDGE) measurement personality	202	3.56 Mbytes
GSM measurement personality	BAH	2.51 Mbytes
EDGE upgrade from BAH measurement personality	252 (202)	3.56 Mbytes
iDEN measurement personality	HN1	2.10 Mbytes
WiDEN measurement personality	HN1	1.58 Mbytes
Baseband I/Q Inputs	B7C	n/a (hardware only)

a. Available as of the print date of this guide.

Memory Upgrade Kits

The PSA 64 MByte Memory Upgrade kit part number is E4440AU-ANE. The PSA Compact Flash Upgrade kit part number is E4440AU-115.

The VSA 64 MByte Memory Upgrade kit part number is E4406AU-ANE.

For more information about memory upgrade kits contact your local sales/service office, or see:
http://www.agilent.com/find/sa_upgrades

Loading an Optional Measurement Personality

You must use a PC to load the desired personality option into the instrument memory. Loading can be done from a firmware CD-ROM or by downloading the update program from the internet. An automatic loading program comes with the files and runs from your PC.

You can check the Agilent internet website for the latest firmware versions available for downloading:

For PSA, see http://www.agilent.com/find/psa_firmware

For E4406A, see http://www.agilent.com/find/e4406a_firmware

NOTE

When you add a new option, or update an existing option, you will get the updated versions of all your current options as they are all reloaded simultaneously. This process may also require you to update the instrument core firmware so that it is compatible with the new option.

Depending on your installed hardware memory, you may not be able to fit all of the available measurement personalities in instrument memory at the same time. You may need to delete an existing option file from memory and load the one you want. Use the automatic update program that is provided with the files. Refer to the table showing “[Measurement Personality Options and Memory Required](#)” on page 59. The approximate memory requirements for the options are listed in this table. These numbers are worst case examples. Some options share components and libraries, therefore the total memory usage of multiple options may not be exactly equal to the combined total.

Obtaining and Installing a License Key

If you purchase an optional personality that requires installation, you will receive an “Entitlement Certificate” which may be redeemed for a license key specific to one instrument. Follow the instructions that accompany the certificate to obtain your license key.

To install a license key for the selected personality option, use the following procedure:

NOTE

You can also use this procedure to reinstall a license key that has been deleted during an uninstall process, or lost due to a memory failure.

For PSA:

1. Press **System, More, More, Licensing, Option** to access the alpha editor. Use this alpha editor to enter letters (upper-case), and the front-panel numeric keys to enter numbers for the option designation. You will validate your option entry in the active function area of the display. Then, press the **Enter** key.
2. Press **License Key** to enter the letters and digits of your license key. You will validate your license key entry in the active function area of the display. Then, press the **Enter** key.
3. Press the **Activate License** key.

For E4406A:

1. Press **System, More, More, Install, Choose Option** to access the alpha editor. Use this alpha editor to enter letters (upper-case), and the front-panel numeric keys to enter numbers for the option designation. You will validate your option entry in the active function area of the display. Then, press the **Done** key.

NOTE

Before you enter the license key for the EDGE Retrofit Option 252, you must already have entered the license key for the GSM Option BAH.

2. Press **License Key** to enter the letters and digits of your license key. You will validate your license key entry in the active function area of the display. Then, press the **Done** key.
3. Press the **Install Now** key. The message “New option keys become active after reboot.” will appear, along with the **Yes/No** menu: press the **Yes** key and cycle the instrument power off and then on to complete your installation process, or press the **No** key to cancel the installation process.

Viewing a License Key

Measurement personalities purchased with your instrument have been installed and activated at the factory before shipment. The instrument requires a **License Key** unique to every measurement personality purchased. The license key is a hexadecimal number specific to your measurement personality, instrument serial number and host ID. It enables you to install, or reactivate that particular personality.

Use the following procedure to display the license key unique to your personality option that is already installed in your instrument:

For PSA:

Press **System, More, More, Licensing, Show License**. The **System, Personality** key displays the personalities loaded, version information, and whether the personality is licensed.

For E4406A:

Press **System, More, More, Install, Choose Option** to enter the letters/numbers for the option you want. You can see the key on the **License Key** softkey. Press the Done key.

NOTE

*You will want to keep a copy of your license key in a secure location. Press **System, More**, then **Licensing, Show License** for PSA, or **Show System** for E4406A, and print out a copy of the display that shows the license numbers. If you should lose your license key, call your nearest Agilent Technologies service or sales office for assistance.*

Using the Delete License Key on PSA

This key will make the option unavailable for use, but will not delete it from memory. Write down the 12-digit license key for the option before you delete it. If you want to use that measurement personality later, you will need the license key to reactivate the personality firmware.

NOTE

Using the **Delete License** key does not remove the personality from the instrument memory, and does not free memory to be available to install another option. If you need to free memory to install another option, refer to the instructions for loading firmware updates located at the URL: <http://www.agilent.com/find/psa/>

1. Press **System, More, More, Licensing, Option**. Pressing the **Option** key will activate the alpha editor menu. Use the alpha editor to enter the letters (upper-case) and the front-panel numeric keyboard to enter the digits (if required) for the option, then press the **Enter** key. As you enter the option, you will see your entry in the active function area of the display.
2. Press **Delete License** to remove the license key from memory.

Using the Uninstall Key on E4406A

This key will make the option unavailable for use, but will not delete it from memory. The message “Application Not Licensed” will appear in the Status/Info bar at the bottom of the display. Record the 12-digit license key for the option before you delete it. If you want to use that measurement personality later, you will need the license key to reactivate the personality firmware.

NOTE

Using the **Uninstall** key does not remove the personality firmware from the instrument memory, and does not free memory to be available to install another option. If you need to free memory to install another option, refer to the instructions for loading firmware updates available at the URL: <http://www.agilent.com/find/vsa/>

1. Press **System, More(1 of 3), More(2 of 3), Uninstall, Choose Option** to access the alpha editor. Use this alpha editor to enter the letters (upper-case), and the front-panel numeric keys to enter the numbers (if required) for the installed option. You will validate your option entry in the active function area of the display. Then, press the **Done** key.
2. Pressing the **Uninstall Now** key will activate the **Yes/No** menu: press the **Yes** key to continue your uninstall process, or press the **No** key to cancel the uninstall process.
3. Cycle the instrument power off and then on to complete the uninstall process.

Ordering Optional Measurement Personalities

When you order a personality option, you will receive an entitlement certificate. Then you will need to go to the web site to redeem your entitlement certificate for a license key. You will need to provide your instrument serial number and host ID, and the entitlement certificate number.

Required Information:	Front Panel Key Path:
Model #: (Ex. E4440A)	
Host ID: _____	System, Show System
Instrument Serial Number: _____	System, Show System

W-CDMA (3GPP) Measurements

This chapter begins with instructions common to all measurements, then details all W-CDMA (3GPP) measurements available by pressing the **MEASURE** key. For information specific to individual measurements refer to the sections at the page numbers below.

- “Channel Power Measurements” on page 74
- “ACPR (ACLR) Measurements” on page 69
- “Intermodulation Measurements” on page 93
- “Multi Carrier Power Measurements” on page 102
- “Spectrum Emission Mask Measurements” on page 145
- “Occupied Bandwidth Measurements” on page 106
- “Code Domain Measurements” on page 77
- “Modulation Accuracy (Composite EVM) Measurements” on page 97
- “QPSK EVM Measurements” on page 120
- “Power Statistics CCDF Measurements” on page 114
- “Power Control Measurements” on page 109
- “Power versus Time (PvT) Mask Measurements” on page 117
- “Spectrum (Frequency Domain) Measurements” on page 125
- “Waveform (Time Domain) Measurements” on page 149
- “Using Option B7C Baseband I/Q Inputs” on page 169
- “Using Basic Mode” on page 182

These are referred to as one-button measurements. When you press the key to select one measurement, it becomes the active measurement, using settings and a display unique to that measurement. Data acquisition automatically begins when trigger requirements, if any, are met.

- “Interpreting Common Error Codes” on page 183

Setting up and Making a Measurement

Making the Initial Signal Connection

CAUTION

Before connecting a signal to the instrument, make sure the instrument can safely accept the signal level provided. The signal level limits are marked next to the connectors on the front panel.

See “[Input Key Menu](#)” on page 119 for details on selecting input ports and setting internal attenuation to prevent overloading the instrument.

For PSA only, the “[Input Key Menu](#)” on page 119 also provides details of **Int Preamp** operation.

Using Instrument Mode and Measurement Presets

If you want to set your current measurement personality to a known, factory default state, press **Preset**. This initializes the instrument by returning the mode setup and all of the measurement setups in the mode to the factory default parameters.

NOTE

For PSA, note that pressing the **Preset** key will switch instrument modes unless the type of preset is selected under **System, Power On/Preset** is set to **Mode** or **Save User Preset**.

To preset only the parameters that are specific to an active, selected measurement, press **Meas Setup**, then **Restore Meas Defaults**. **Restore Meas Defaults** will return all the measurement setup parameters to the factory defaults, but only for the currently selected measurement. The **Restore Meas Defaults** key may not appear on the first page of the **Meas Setup** menu. If not, press **More** until the key is available.

The 3 Steps to Set Up and Make Measurements

All measurements need to be set up in 3 steps: first at the Mode level, second at the Measurement level, then finally the result display may be adjusted.

1. Select and Set Up the Mode

Press **MODE** - All licensed, installed Modes available are shown. Press **Digital Modulation 1xEV-DOcdma2000 or cdma2000 w/1xEV-DVW-CDMA (3GPP)** or **W-CDMA w/HSDPA/HSUPA**, or select **Basic** mode to make measurements of signals with non-standard formats.

Press **Mode Setup** - Make any required adjustments to the mode settings. These settings apply to all measurement in the mode.

2. Select and Set Up the Measurement

Press **MEASURE** - Select **Modulation Analysis** a specific measurement to be performed (e.g. **ACP**, **Spectrum** or **Waveform**). The measurement begins as soon as any required trigger conditions are met. The resulting data is shown on the display or is available for export.

Press **Meas Setup** - Make any adjustments as required to the selected measurement settings. The settings only apply to this measurement.

3. Select and Set Up a View of the Results

Press **Trace/View** - Select a display format for the current measurement data. Depending on the mode and measurement selected, other graphical and tabular data presentations may be available. **X-Scale** and **Y-Scale** adjustments may also be made now.

NOTE

A setting may be reset at any time, and will be in effect on the next measurement cycle or View.

Step	Primary Key	Setup Keys	Related Keys
1. Select & set up a Mode	MODE	Mode Setup, Input (E4406A), Input/Output (PSA), FREQUENCY Channel	System
2. Select & set up a Measurement	MEASURE	Meas Setup	Meas Control, Restart
3. Select & set up a View of the Results	View/Trace (E4406A), Trace/View (PSA)	SPAN X Scale, AMPLITUDE Y Scale, Display, Next Window, Zoom	File, Save, Print, Print Setup, Marker, Search (E4406A), Peak Search (PSA)

ACPR (ACLR) Measurements

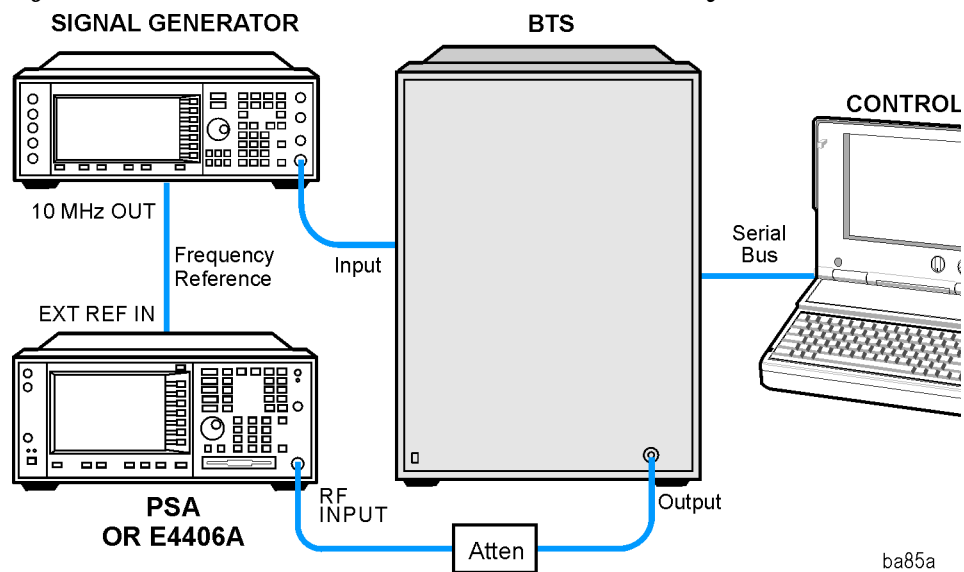
This section explains how to make the adjacent channel leakage power ratio (ACLR or ACPR) measurement on a W-CDMA (3GPP) mobile station. ACPR is a measurement of the amount of interference, or power, in an adjacent frequency channel. The results are displayed as a bar graph or as spectrum data, with measurement data at specified offsets.

Configuring the Measurement System

The mobile station (MS) under test has to be set to transmit the RF power remotely through the system controller. This transmitting signal is connected to the instruments RF input port. Connect the equipment as shown.

Figure 2-1

Adjacent Channel Power Ratio Measurement System



1. Using the appropriate cables, adapters, and circulator, connect the output signal from the MS to the RF input port of the instrument.
2. Connect the base transmission station simulator or signal generator to the MS through the circulator to initiate a link constructed with the sync and pilot channels, if required.
3. Connect a BNC cable between the 10 MHz OUT port of the signal generator and the EXT REF IN port of the instrument.
4. Connect the system controller to the MS through the serial bus cable to control the MS operation.

Setting the MS (Example)

From the UE transmission station simulator and/or the system controller, perform all of the call acquisition functions required for the MS to transmit the RF power as follows:

Frequency: 1,920 MHz (Channel Number: $5 \times 1,920 = 9,600$)

Physical Channels: DPCCH with 4 DPDCH

Scramble Code: 0

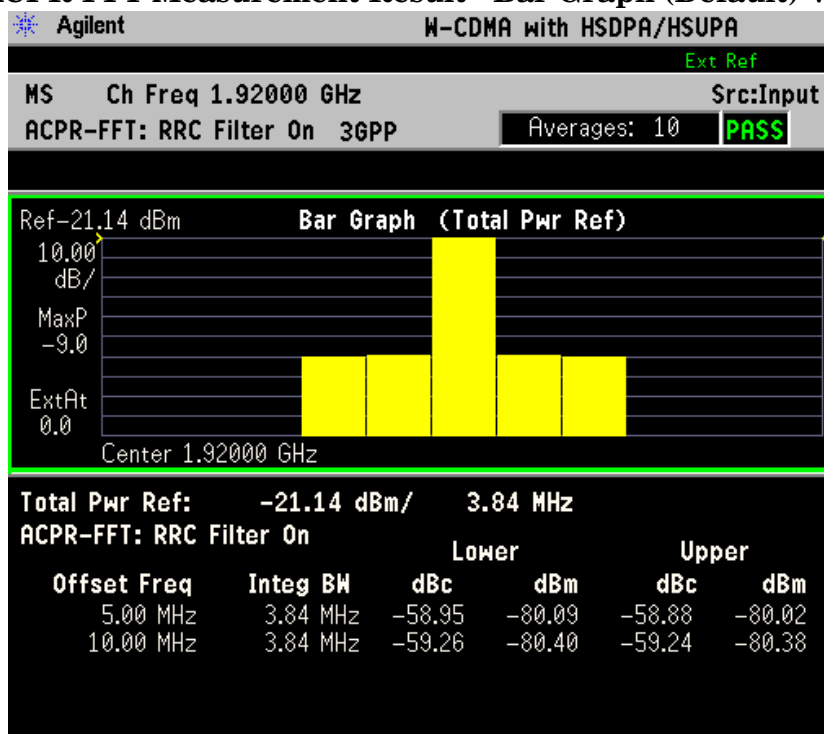
Output Power: -20 dBm (at analyzer input)

Measurement Procedure

- Step 1.** Press the **Preset** key to preset the instrument.
- Step 2.** Press the **MODE, More (1 of 2), W-CDMA (3GPP)** keys to enable the W-CDMA (3GPP) measurements.
- Step 3.** Press the **Mode Setup, Radio, Device** to toggle the device to **MS**.
- Step 4.** Press the **FREQUENCY Channel, 1920, MHz** keys to set the center frequency to 1.920 GHz.
- Step 5.** Press the **MEASURE, ACPR (ACLR)** keys to initiate the adjacent channel leakage power ratio measurement.

Figure 2-2

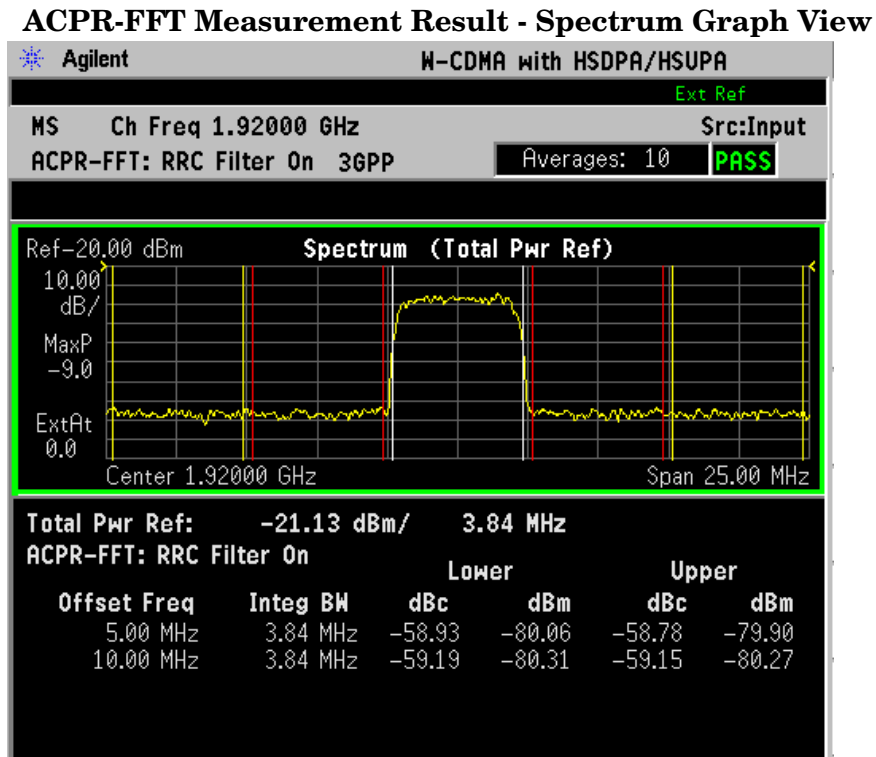
ACPR-FFT Measurement Result - Bar Graph (Default) View



The ACPR-FFT Bar Graph measurement result should look like [Figure 2-2](#). The bar graph (referenced to the total power) and a text window are displayed. The text window shows the absolute total power reference, while the lower and upper offset channel power levels are displayed in both absolute and relative readings.

- Step 6.** Press the **View/Trace, Spectrum** keys to see the ACPR-FFT: Spectrum graph with the bandwidth marker lines in the graph window. The corresponding measured data is also shown in the text window. See [Figure 2-3](#).

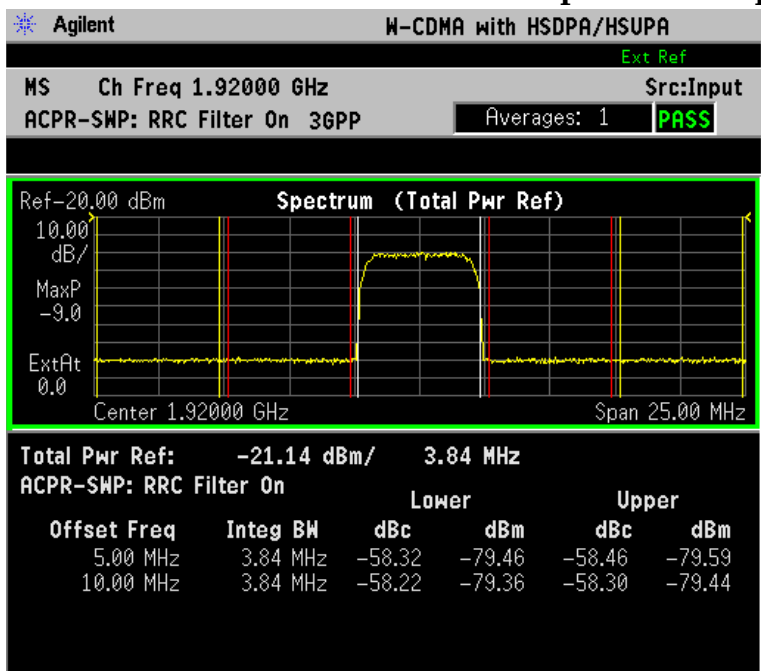
Figure 2-3



Step 7. Press the **Meas Setup, More (1 of 2), Sweep Type** keys to select **Swp**. The ACPR-SWP: measurement result display is shown below. The **Integration Bandwidth** is indicated by vertical white lines. The vertical red lines indicate the Offset frequencies. See [Figure 2-4](#).

Figure 2-4

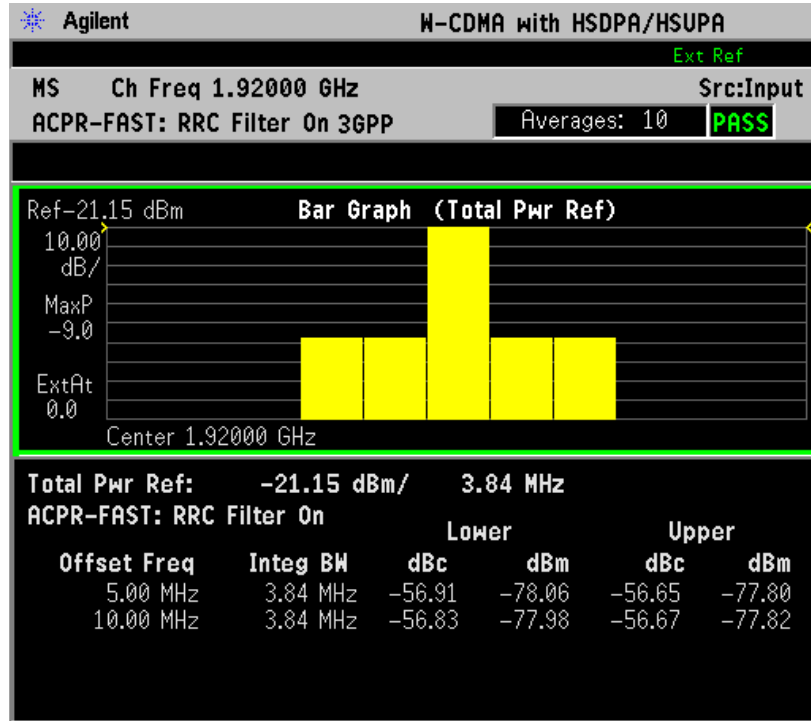
ACPR- SWP Measurement Result - Spectrum Graph View



Step 8. Press the **Sweep Type** key one more time to change the Sweep Type to **Fast**. The display will change to ACPR-FAST: Bar Graph. The measurement speed is faster than the ACPR-FFT: Bar Graph measurement. (See [Figure 2-5](#))

Figure 2-5

ACPR- FAST Measurement Result - Bar Graph View



Step 9. Press the **Meas Setup, More (1 of 2)** keys to check what keys are available to change the measurement parameters from the default condition.

If you have a problem, and get an error message, see [“Interpreting Common Error Codes” on page 183](#) or the “Instrument Messages and Functional Tests” manual.

Channel Power Measurements

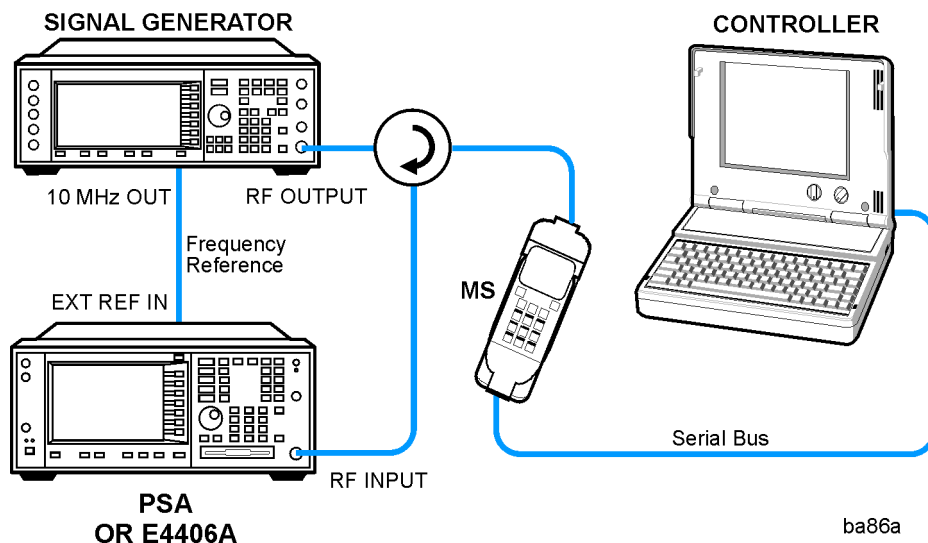
This section explains how to make a channel power measurement on a W-CDMA (3GPP) mobile station. This test measures the total RF power present in the channel. The results are displayed graphically as well as in total power (dB) and power spectral density (dBm/Hz). If you install option 210 HSDPA/HSUPA measurement personality license, Code Domain and Modulation Accuracy can measure HSDPA/HSUPA signals as well.

Configuring the Measurement System

The mobile station (MS) under test has to be set to transmit the RF power remotely through the system controller. This transmitting signal is connected to the instruments RF input port. Connect the equipment as shown.

Figure 2-6

Channel Power Measurement System



1. Using the appropriate cables, adapters, and circulator, connect the output signal from the MS to the RF input port of the instrument.
2. Connect the base transmission station simulator or signal generator to the MS through the circulator to initiate a link constructed with the sync and pilot channels, if required.
3. Connect a BNC cable between the 10 MHz OUT port of the signal generator and the EXT REF IN port of the instrument.
4. Connect the system controller to the MS through the serial bus cable to control the MS operation.

Setting the MS (Example)

From the UE transmission station simulator and/or the system controller, perform all of the call acquisition functions required for the MS to transmit the RF power as follows:

Frequency: 1,920 MHz (Channel Number: $5 \times 1,920 = 9,600$)

Output Power: -20 dBm (at analyzer input)

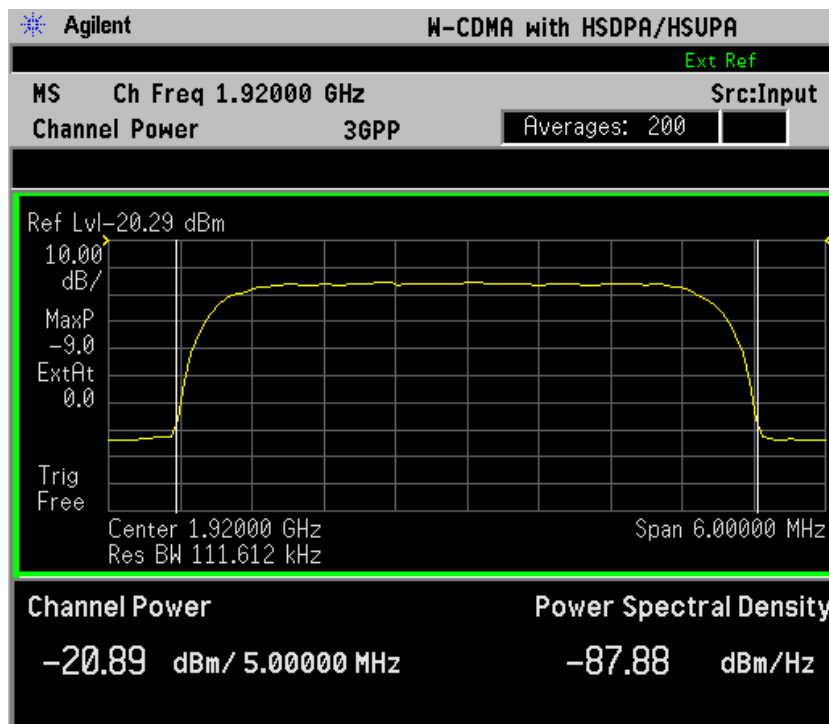
Measurement Procedure

- Step 1.** Press the **Preset** key to preset the instrument.
- Step 2.** Press the **MODE, More (1 of 2), W-CDMA (3GPP)** keys to enable the W-CDMA (3GPP) measurements.
- Step 3.** Press the **Mode Setup, Radio, Device** to toggle the device to MS.
- Step 4.** Press the **FREQUENCY Channel, 1920, MHz** keys to set the center frequency to 1.920 GHz.
- Step 5.** Press the **MEASURE, Channel Power** keys to initiate the channel power measurement.

The Channel Power measurement result should look like [Figure 2-7](#). The graph window and the text window showing the absolute power and its mean power spectral density values over 5 MHz are displayed.

Figure 2-7

Channel Power Measurement Result



Step 6. Press the **Meas Setup, More (1 of 2)** keys to check what keys are available to change the measurement parameters from their default condition.

If you have a problem, and get an error message, see [“Interpreting Common Error Codes” on page 183](#) or the “Instrument Messages and Functional Tests” manual.

Code Domain Measurements

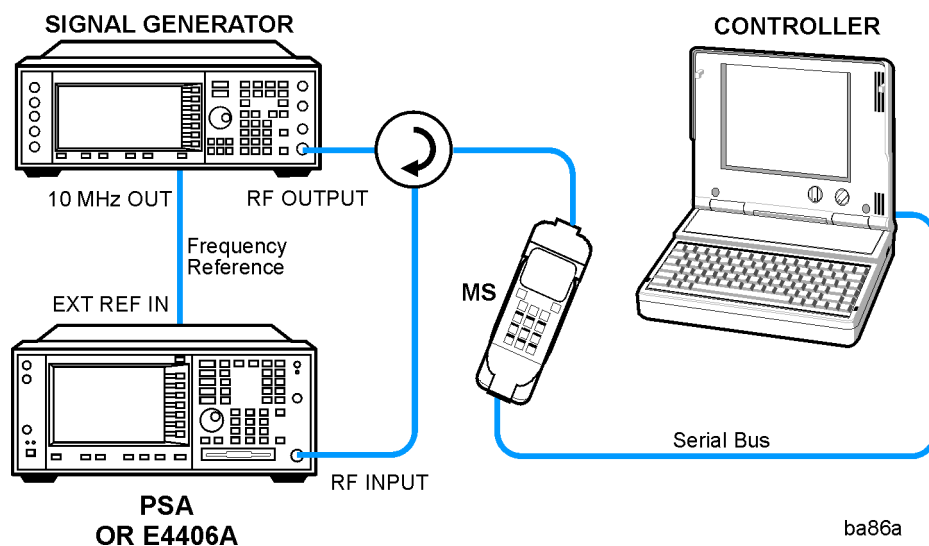
This section explains how to make a code domain measurement on W-CDMA (3GPP) MS and BTS. This is the measurement of power levels of the spread code channels across composite RF channels. The code power may be measured relative to the total power within the 3.840 MHz channel bandwidth, or absolutely, in units of power.

Code Domain measurement examples using a W-CDMA (UL) signal and a HSDPA (DL) signal are shown in this section.

Configuring the Measurement System

For configuring the measurement system, the mobile station (MS) under test has to be set to transmit the RF power remotely through the system controller. This transmitting signal is connected to the instruments RF input port. Connect the equipment as shown.

Figure 2-8 Code Domain Power Measurement System



1. Using the appropriate cables, adapters, and circulator, connect the output signal of the MS to the RF input of the instrument.
2. Connect the base transmission station simulator or signal generator to the MS through the circulator to initiate a link constructed with the sync and pilot channels, if required.
3. Connect a BNC cable between the 10 MHz OUT port of the signal generator and the EXT REF IN port of the instrument.
4. Connect the system controller to the MS through the serial bus cable to control the MS operation.

W-CDMA UL Measurement Example (Normal Mode)

Setting the MS (Example)

From the mobile station simulator and/or the system controller, perform all of the call acquisition functions required for the MS to transmit the RF power as follows:

Frequency: 1,920 MHz (Channel Number: $5 \times 1,920 = 9,600$)

Physical Channels: DPCCH with 4 DPDCH

Scramble Code: 0

Output Power: -20 dBm (at analyzer input)

Measurement Procedure

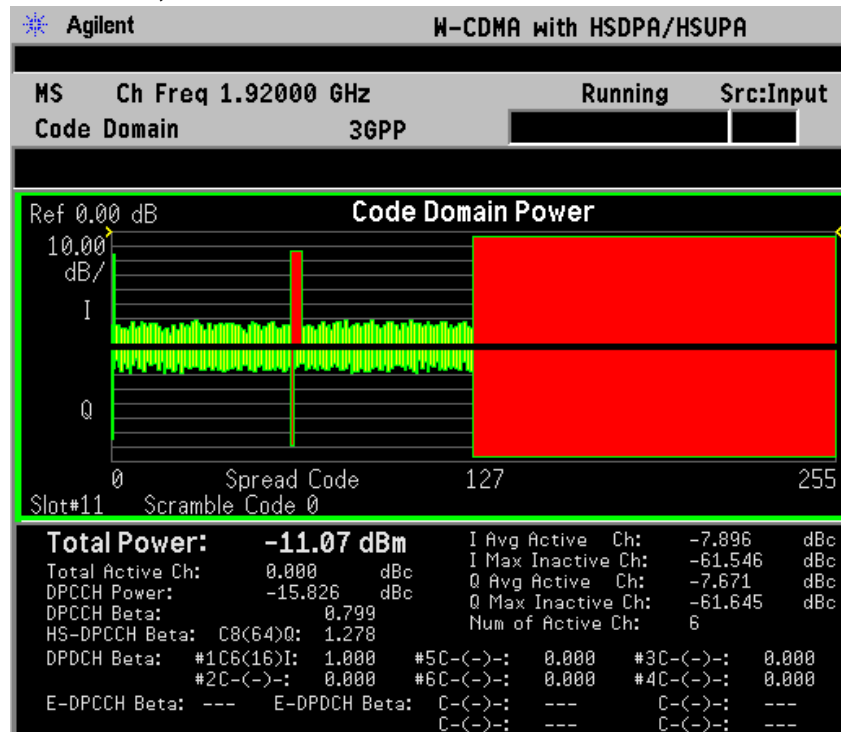
- Step 1.** Press the **Preset** key to preset the instrument.
- Step 2.** Press the **MODE, More (1 of 2), W-CDMA (3GPP)** keys to enable the W-CDMA w/HSDPA/HSUPA measurements.
- Step 3.** Press the **Mode Setup, Radio, Device** to toggle the device to **MS**.
- Step 4.** Press the **FREQUENCY Channel, 1920, MHz** keys to set the center frequency to 1.920 GHz.
- Step 5.** Press the **MEASURE, More (1 of 2), Code Domain** keys to initiate the code domain measurement.

The Code Domain: Power measurement result should look like [Figure 2-9](#). The graph window is displayed with a text window below it. The text window shows the total power level along with the relative power levels of the various channels.

The sample screen shows the following HSUPA configured channels in code domain. On I axis, DPDCH, E-DPCCH, and E-DPDCH. On Q axis, DPCCH, HS-DPCCH and another E-DPDCH.

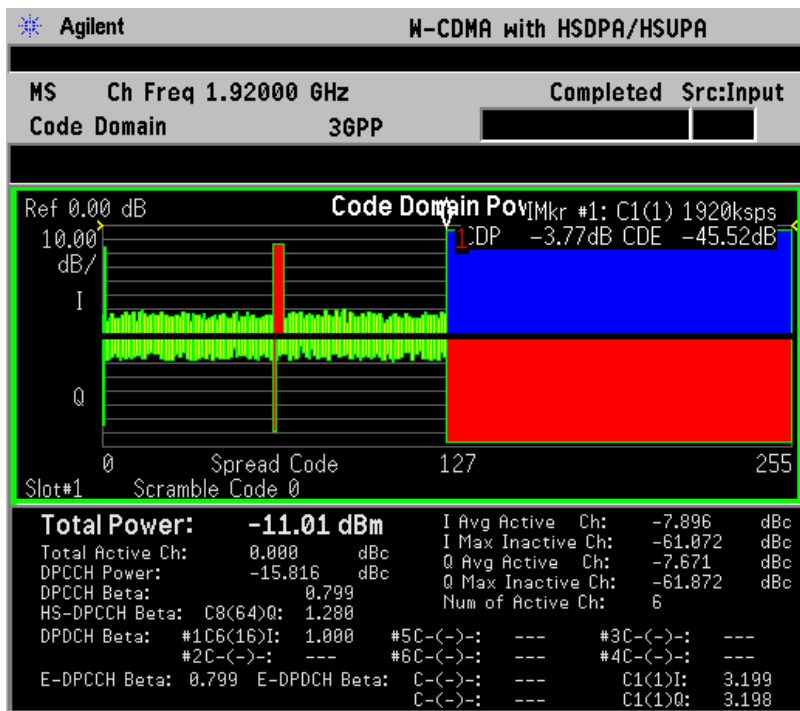
Figure 2-9

Code Domain Measurement Result - Power Graph and Metrics (Default) View - Uplink (MS) DPCCH,DPDCH,HS-DPCCH, E-DPCCH, and 2 E-DPDCH



Step 6. Press **Peak Search (PSA)** or **Peak (VSA)** to put a marker on the highest power channel. (See [Figure 2-10](#)). It shows the result of the code channel with marker as C1(1), which indicates code channel number 1 with SF $2^1 = 2$. E-DPDCH for HSUPA shall have the symbol rate up to 1920 ksps as this sample. CDP (Code Domain Power) and CDE (Code Domain Error) of the channel can be checked with the marker. The result summary shows the total power of the signal, relative code power of active data channels, and power beta values. For correct beta calculation, DPCH/E-DPCH Config should be selected correctly under **Meas Setup**.

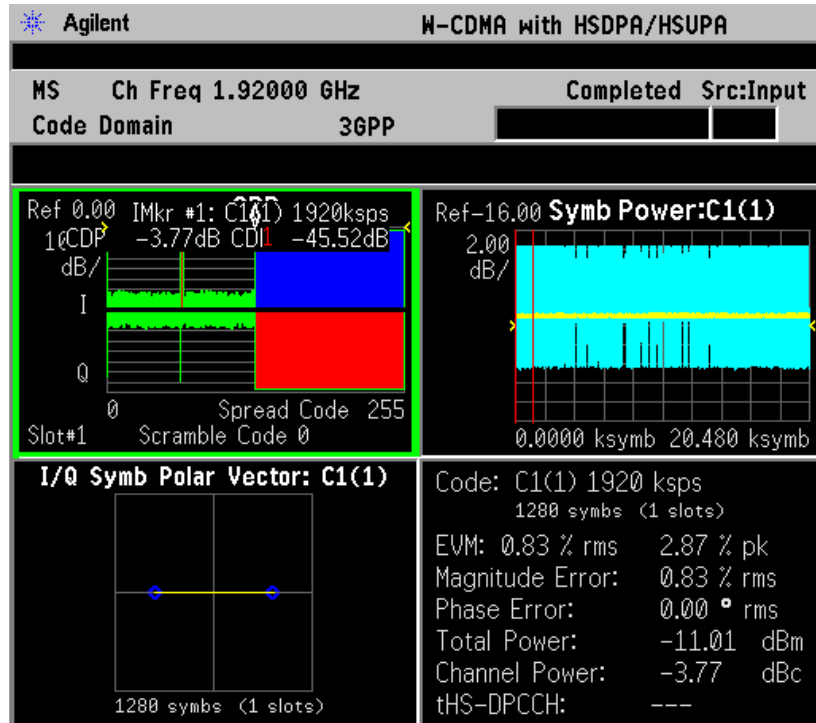
Figure 2-10 Code Domain Measurement Result - Power Graph and Metrics View - Uplink (MS) DPCCCH, DPDCH, HS-DPCCH, E-DPCCH, and 2 E-DPDCH w/ Peak Marker



- Step 7.** Press **Marker, More, Mkr-> Despread** to initiate the despreading and decoding of the marked channel to allow EVM and other error measurements to be conducted on the channel.
- Step 8.** Press the **View/Trace, Code Domain (Quad View)** key to display a combination view of the code domain power, symbol power, and I/Q symbol polar vector graph windows, with a summary results window as shown below:

Figure 2-11

Code Domain Measurement Result - Code Domain Quad View



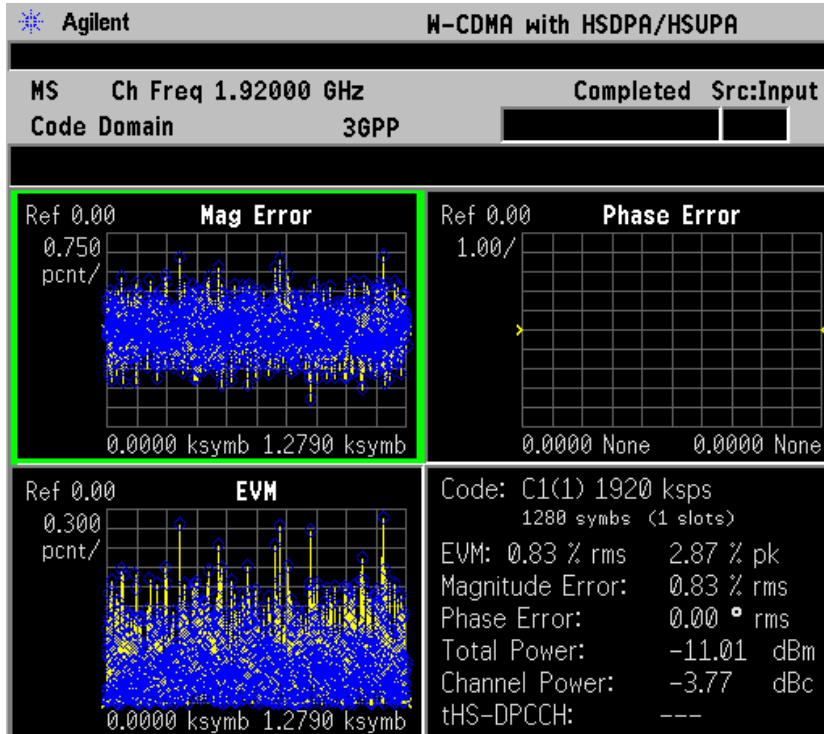
The Symbol Power vs. Time (PvT) measurement of the marked I-data channel is at the top right. The solid area below the first graticule (blue on the instrument display) is the composite chip power versus time over the entire capture interval (20.480 k symbols), while the (yellow) horizontal line is symbol power versus time for C1(1). The Capture Interval is 1 frame, but the measured interval is 1 slot. The 2 vertical red lines in the PvT graph indicate the measurement interval, with the default measurement offset of 0 slots. The graph of the I/Q vector trajectory for C1(1) during the measurement interval is shown at lower left.

As the constellation diagram shows at the lower left, this example uses I-only data that is effectively BPSK modulation for channel C1(1), so the phase error must be zero.

Step 9. Press the **View/Trace, I/Q Error (Quad View)** keys to display a combination view of the magnitude error vs. time, phase error vs. time, and EVM vs. time graph windows, with the modulation summary results window as shown below:

Figure 2-12

Code Domain Measurement Result - I/Q Error Quad View



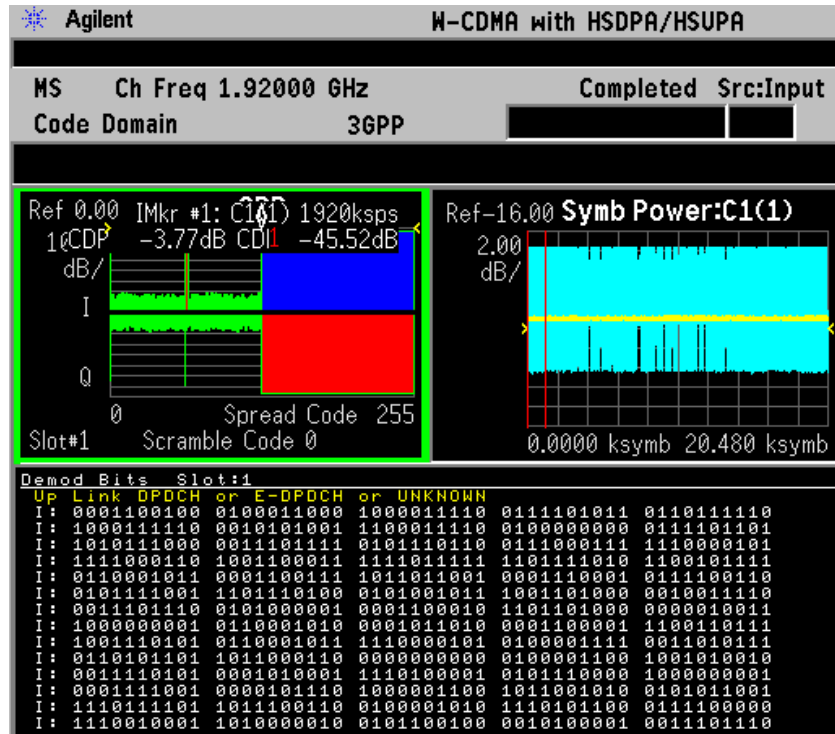
The above screen shows the data for the same code domain channel C1(1) that was selected for despreading by the marker in the Code Domain Quad View in the previous step.

Again, this example uses I-only data that is effectively BPSK modulation for channel C1(1), the phase error must be zero.

Step 10. Press the **View/Trace, Demod Bits** key to display a combination view of the code domain power, symbol power graph windows, and the I/Q demodulated bit stream data for the symbol power slots selected by the measurement interval and measurement offset parameters.

Figure 2-13

Code Domain Measurement Result - Demod Bits View



The Demod Bits View displays the same Code Domain Power and Symbol Power windows as the Code Domain (Quad View) shown in Figure 2-11 on page 81

The demodulated bit stream displayed is the data contained in the Measurement Interval, slot #1. In the PvT graph, this is the data between the red vertical lines; 1 slot, with no offset, so it is the first slot of the Capture Interval of 1 frame. For more details of these adjustments see “Code Domain Keys” on page 232

Step 11. To make measurements repeatedly, press the **Meas Control, Measure** keys to change the Meas Control from **Single** to **Cont**.

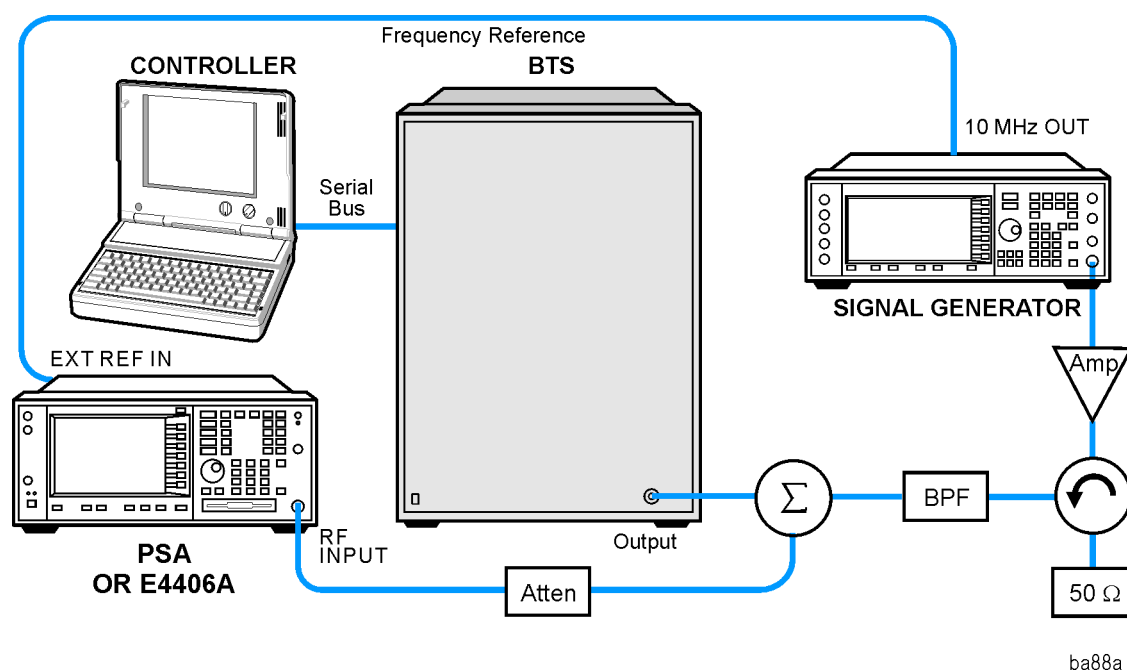
If you have a problem, and get an error message, see “Interpreting Common Error Codes” on page 183 or the “Instrument Messages and Functional Tests” manual.

HSDPA DL Measurement Example (Test Model 5)

Configuring the Measurement System

The base transmission station (BTS) under test has to be set to transmit the RF power remotely through the system controller. The W-CDMA modulated interference signal is injected to the antenna output port of the BTS through an attenuator and circulator. The transmitting signal from the BTS is connected to the RF input port of the instrument from the circulator port. Connect the equipment as shown.

Figure 2-14 Intermodulation Product Measurement System



1. Using the appropriate amplifier, circulator, bandpass filter, combiner, cables, and adapters, connect the unmodulated carrier signal from the signal generator to the output connector of the BTS.
2. Connect the circulator output signal to the RF input port of the instrument through the attenuator.
3. Connect a BNC cable between the 10 MHz OUT port of the signal generator and the EXT REF IN port of the instrument.
4. Connect the system controller to the BTS through the serial bus cable.

Setting the BS (Example)

From the base transmission station simulator and/or the system controller, perform all of the call acquisition functions required for the MS to transmit the RF power as follows:

Frequency: 1,000 MHz

Physical Channels: Test Model 5 with 8 HS-PDSCH

Scramble Code: 0

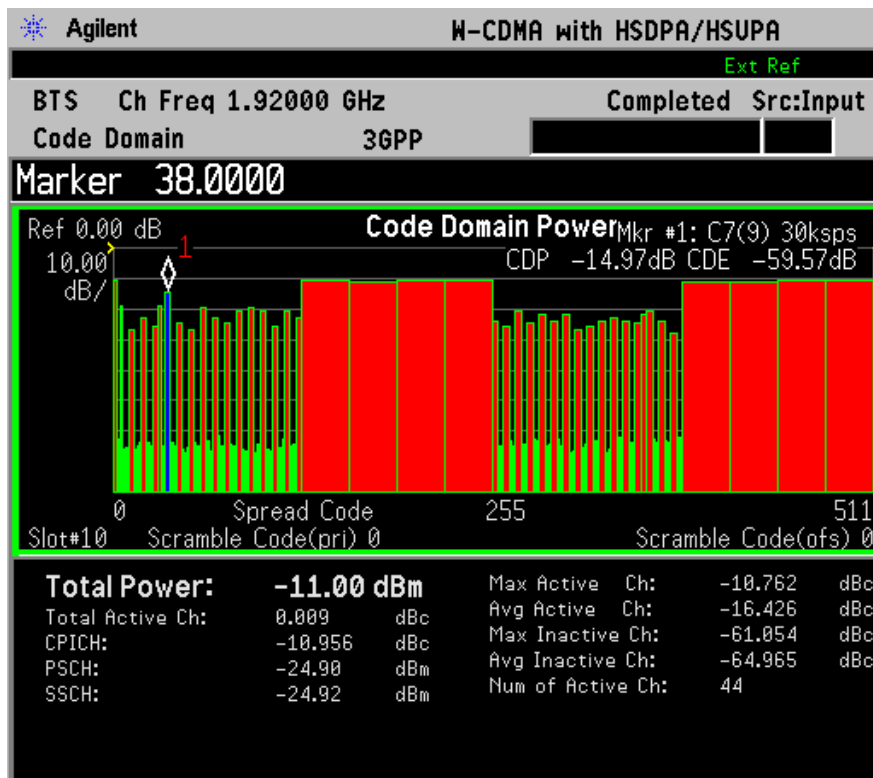
Output Power: -10 dBm

Measurement Procedure

- Step 1.** Press the **Preset** key to preset the instrument.
- Step 2.** Press the **MODE, More (1 of 2), W-CDMA w/HSDPA** keys to enable the W-CDMA w/HSDPA/HSUPA measurements.
- Step 3.** Press the **Mode Setup, Radio, Device** to toggle the device to **BTS**.
- Step 4.** Press the **FREQUENCY Channel, 1000, MHz** keys to set the center frequency to 1.000 GHz.
- Step 5.** Press the **MEASURE, More (1 of 2), Code Domain** keys to initiate the code domain measurement.

Step 6. Press **Meas Setup, More, Symbol Boundary, Predefined Test Models, Test Model 5, Test Model 5 w/ 8 HS-PDSCH.**

Figure 2-15 Code Domain Measurement Result - Power Graph and Metrics (Default) View - Downlink (BS) Test Model 5



The Code Domain: Power measurement result should look like [Figure 2-15](#). The graph window is displayed with a text window below it. The text window shows the total power level along with the relative power levels of the various channels.

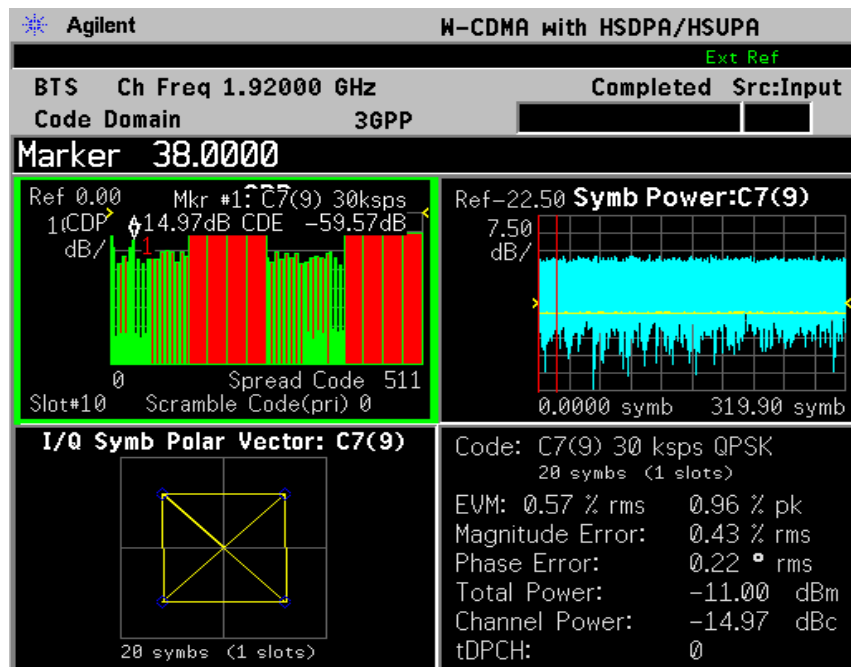
Now let's examine a single HSDPA code channel in the code domain more closely:

Step 7. Press **Marker**, and enter the number 38 via the front panel keypad.

Step 8. Press **Marker, More, Mkr-> Despread** to initiate the despreading and decoding of the marked channel to allow EVM and other error measurements to be conducted on the channel.

Step 9. Press the **View/Trace, Code Domain (Quad View)** key to display the combination view of the code domain power, symbol power, and I/Q symbol polar vector graph windows, and summary results window as shown below:

Figure 2-16 Code Domain Measurement Result - Code Domain Quad View - HSDPA DL Test Model 5



The original Code Domain Measurement with the marker at code channel 38 is shown at the top left, while the Symbol Power vs. Time (PvT) measurement of the marked channel is at the top right. The solid area below the first gradicule (blue on the instrument display) is the composite chip power versus time over the entire capture interval, while the (yellow) horizontal line is Symbol power versus time for C7(9).

The 2 vertical red lines in the PvT graph indicate the measurement interval, with the default measurement offset of 0 slots. The graph of the I/Q vector trajectory for C7(9) during the measurement interval is shown at lower left. The summary data at lower right indicates peak and RMS EVM, magnitude and phase errors, powers of signal and channel.

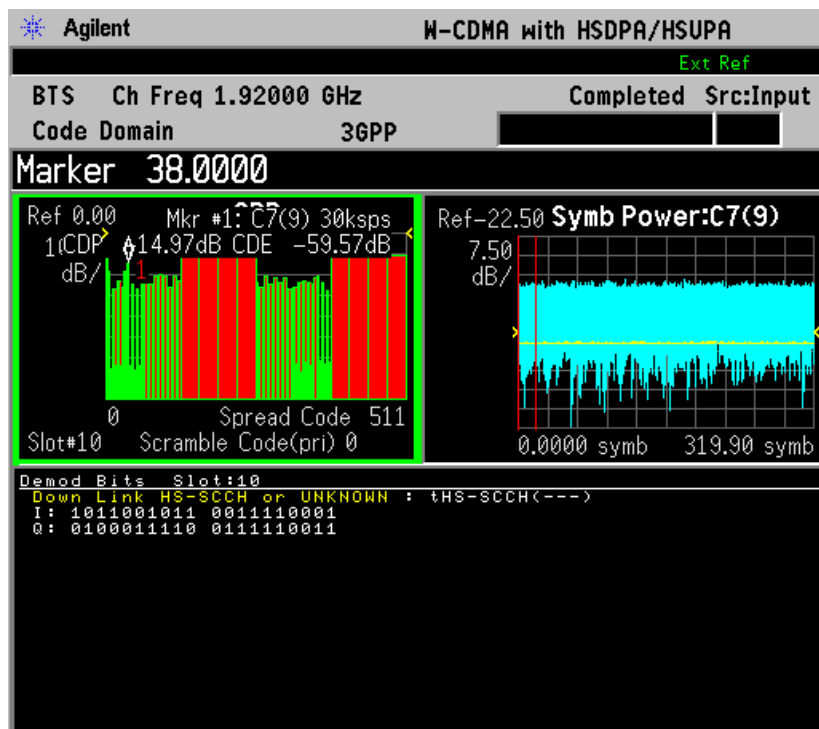
The code channel at C7(9) is HS-SCCH, a new code channel for HSDPA (See “HSDPA Concepts” on page 419.)

Step 10. Optimize your measurement results: several Code Domain Power measurement functions have been developed by Agilent to help you to obtain improved accuracy under difficult measurement conditions. Some of these tools include the Multi Channel Estimator, Timing Estimation function, Sync Channel Suppression, and Symbol EVM Compensation. Some of these are active by default, while others can be selected for you particular application. All these functions are available in the **Meas Setup, Advanced** menu. See “[Measurement Setup Key Menu](#)” on page 210.

TIP If your EVM or Phase Error results are high, and you have many code channels in your signal, try using the Multi Channel Estimator to improve your measurement result. Press **Meas Setup, Advanced**, and toggle the **Multi Channel Estimator** key to **ON**.

Step 11. Press the **View/Trace, Demod Bits** key to display the combination view of the code domain power, symbol power graph windows, and the I/Q demodulated bit stream data for the symbol power slots selected by the measurement interval and measurement offset parameters.

Figure 2-17 Code Domain Measurement Result - Demod Bits View - HSDPA DL Test Model 5

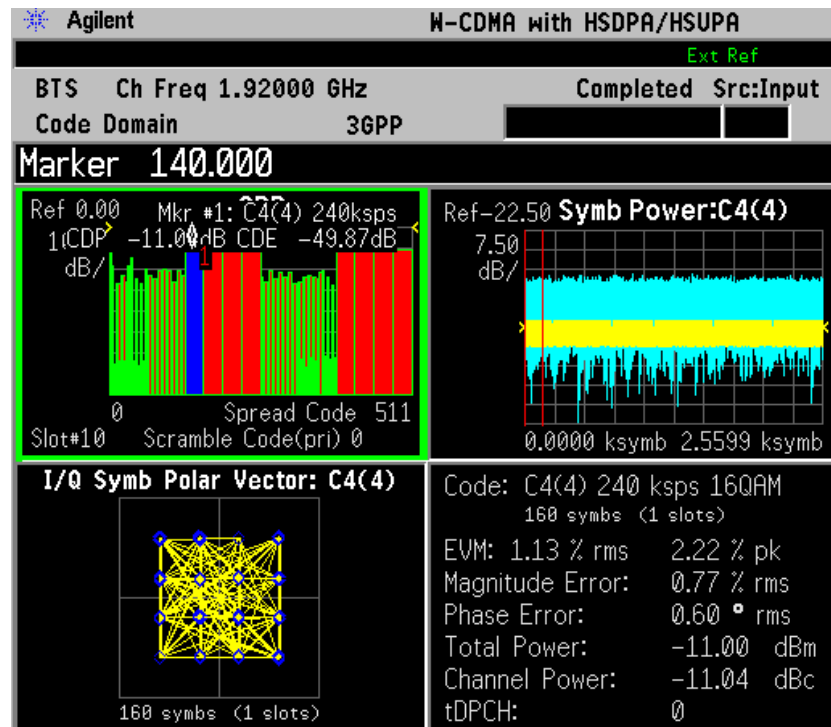


The Demod Bits View displays the same Code Domain Power and Symbol Power windows as the Code Domain (Quad View) shown in Figure 2-11 on page 81

The demodulated bit stream displayed is the data contained in the Measurement Interval (1 slot, with no offset, so it is the first slot) of the Capture Interval of 2 frames. For details of these adjustments see “Measurement Setup Key Menu” on page 210. Let’s look more closely at another HSDPA code channel: HS-PDCSH.

- Step 12.** Press the **View/Trace, Power Graph and Metrics** keys to display the primary code domain power view and summary results window.
- Step 13.** Press **Marker**, and enter **140, ENTER** via the front panel keypad.
- Step 14.** Press **Marker, More, Mkr-> Despread** to initiate the despreading and decoding of the marked channel to allow EVM and other error measurements to be conducted on the channel. It may be necessary to press **Restart** if the **Meas Control, Measure** setting is on **Single**.
- Step 15.** Press the **View/Trace, Code Domain (Quad View)** key to display the combination view of the code domain power, symbol power, and I/Q symbol polar vector graph windows, and summary results window.

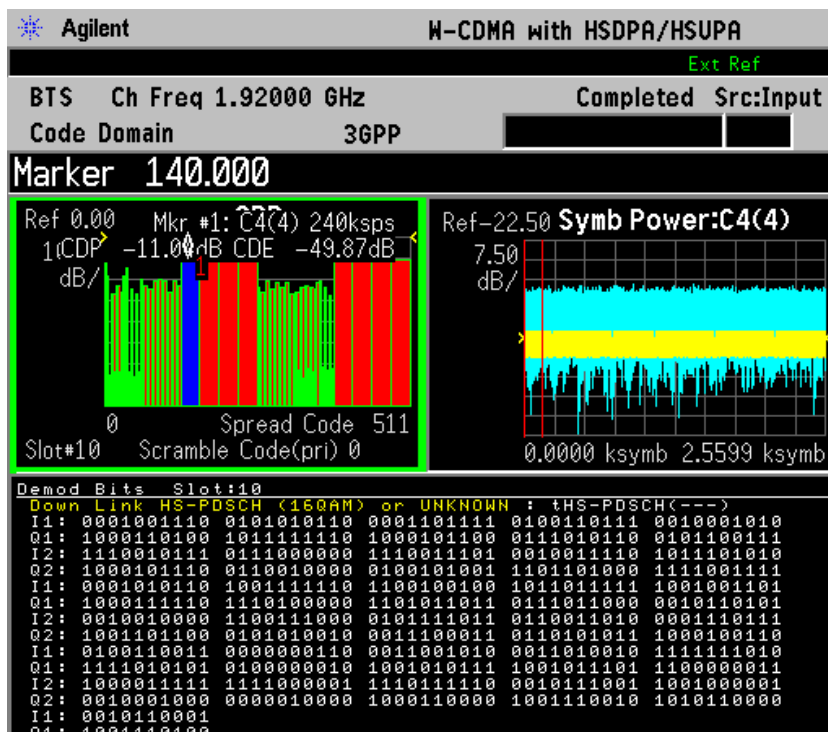
Figure 2-18 Code Domain Measurement Result - Code Domain Quad View - HSDPA DL Test Model 5



This code channel C4(4) is the HS-PDSCH, unique to HSDPA, and present in Test Model 5. The difference in symbol power vs. time can be clearly seen. The 16QAM modulation is also displayed, instead of the normal QPSK for W-CDMA DPCH channels.

- Step 16.** Press the **View/Trace, Demod Bits** key again to display the I/Q demodulated bit stream data for the symbol power slots selected by the measurement interval and measurement offset parameters.

Figure 2-19 Code Domain Measurement Result - Demod Bits View (Binary)



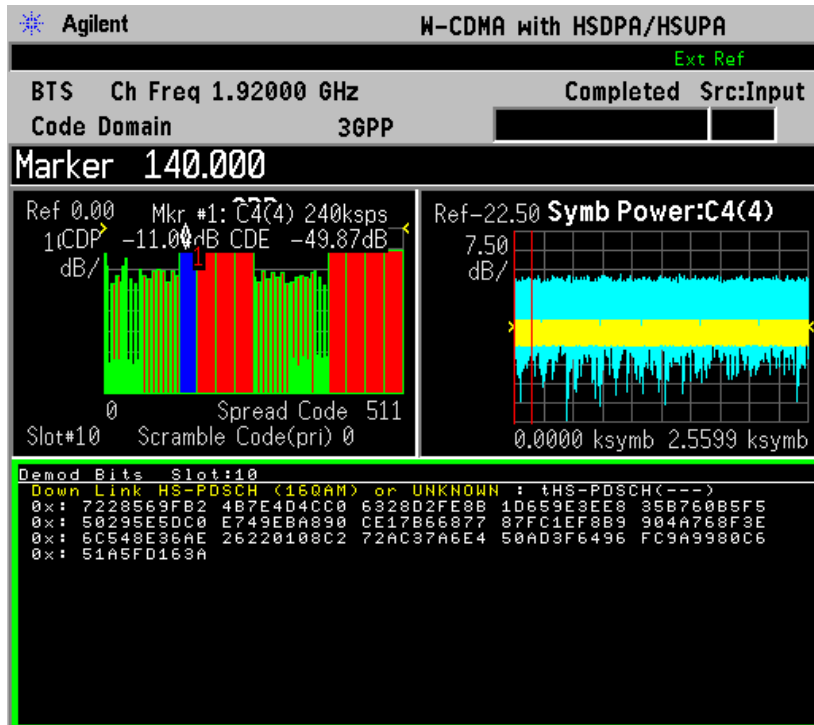
The demodulated bits for slot 10 are shown in Binary format. You can also view the bit stream in Hexadecimal format.

- Step 17.** Press **Next Window** twice to select Demod Bits as the active window with the green outline. When Demod Bits is active you can access a menu allowing you to page through the data or change the bit format.

Press the **Display, Demod Bit Format** key to toggle the demodulated bit stream display from **Binary** to **Hex**. (See [Figure 2-20](#))

Figure 2-20

Code Domain Measurement Result - Demod Bits View (Hex)



NOTE

The **Demod Bit Format** key is only available 16 QAM modulated code channels. For other code channels like the DPCH, only the Binary data bit stream is available.

Step 18. To make measurements repeatedly, press the **Meas Control, Measure** keys to change the Meas Control from **Single** to **Cont**.

If you have a problem, and get an error message, see [“Interpreting Common Error Codes” on page 183](#) or the “Instrument Messages and Functional Tests” manual.

Troubleshooting Hints

Uncorrelated interference may cause CW interference like local oscillator feedthrough or spurs. Another cause of uncorrelated noise can be I/Q modulation impairments. Correlated impairments can be due to the phase noise on the local oscillator in the upconverter or I/Q modulator of the UUT. These will be analyzed by the code domain measurements along with the QPSK EVM measurements and others.

Poor phase error indicates a problem at the I/Q baseband generator, filters, and/or modulator in the transmitter circuitry of the UUT. The output amplifier in the transmitter can also create distortion that causes unacceptably high phase error. In a real system, poor phase error will reduce the ability of a receiver to correctly demodulate the received signal, especially in marginal signal conditions.

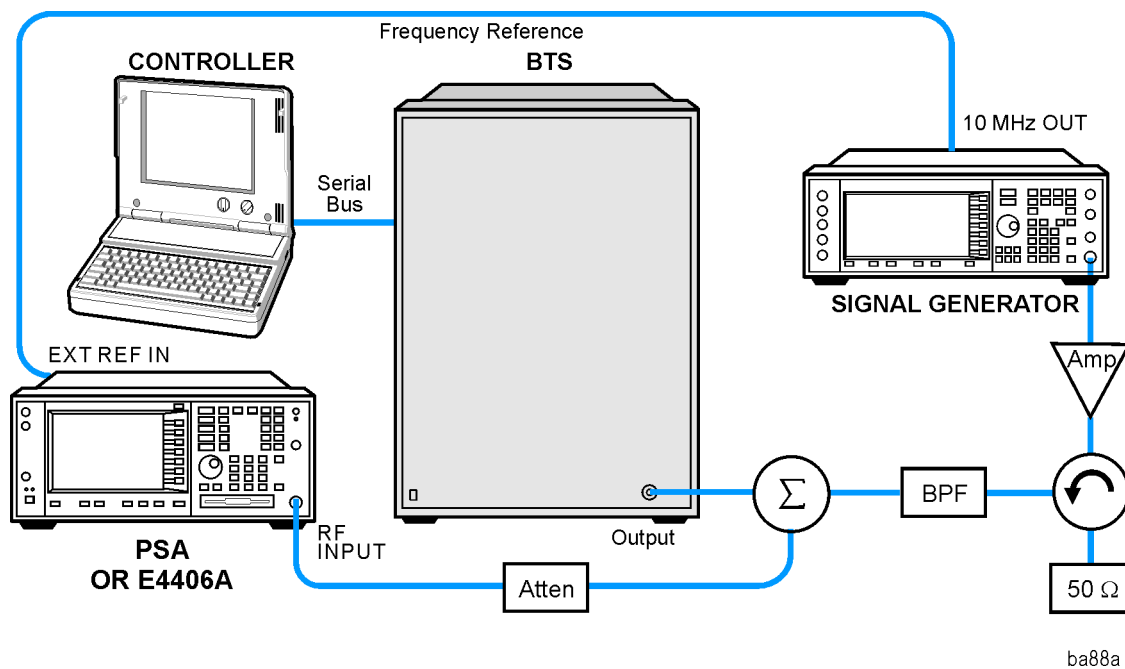
Intermodulation Measurements

This section explains how to make the intermodulation products measurement on a W-CDMA (3GPP) base transmission station. The instrument, by default, measures the third- and fifth-order intermodulation products of the base frequency signal. Either two-tone or transmit intermodulation products are automatically identified.

Configuring the Measurement System

The base transmission station (BTS) under test has to be set to transmit the RF power remotely through the system controller. The W-CDMA modulated interference signal is injected to the antenna output port of the BTS through an attenuator and circulator. The transmitting signal from the BTS is connected to the RF input port of the instrument from the circulator port. Connect the equipment as shown.

Figure 2-21 Intermodulation Product Measurement System



1. Using the appropriate amplifier, circulator, bandpass filter, combiner, cables, and adapters, connect the unmodulated carrier signal from the signal generator to the output connector of the BTS.
2. Connect the circulator output signal to the RF input port of the instrument through the attenuator.

3. Connect a BNC cable between the 10 MHz OUT port of the signal generator and the EXT REF IN port of the instrument.
4. Connect the system controller to the BTS through the serial bus cable.

Setting the BTS and Signal Generator

From the system controller, perform all of the call acquisition functions required for the BTS to transmit the RF signal. Set the signal generator to output a 5 MHz offset carrier signal to make the intermodulation measurement with the transmit IM and tone signals.

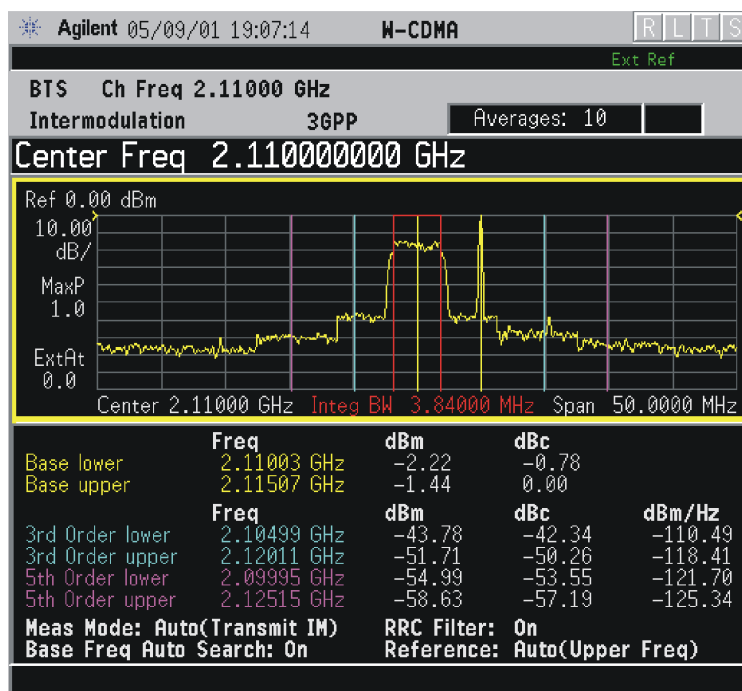
- BTS (transmit intermodulation signal)
 - Frequency: 2,110 MHz (Channel Number: $5 \times 2,110 = 10,550$)
 - Signal: Test model 1
 - Output Power: Specified maximum output power level
- Signal Generator (interference carrier signal)
 - Frequency: 2,115 MHz (Channel Number: $5 \times 2,115 = 10,575$)
 - Signal: CW (unmodulated carrier)
 - Output Power: Same level to the BTS output power at the BTS antenna output port

Measurement Procedure

- Step 1.** Press the **Preset** key to preset the instrument.
- Step 2.** Press the **Mode, More (1 of 2), W-CDMA (3GPP)** keys to enable the W-CDMA (3GPP) measurements.
- Step 3.** Press the **Mode Setup, Radio, Device** to toggle the device to **BTS**.
- Step 4.** Press the **FREQUENCY Channel, 2110, MHz** keys to set the center frequency to 2.110 GHz.
- Step 5.** Press the **MEASURE, Intermod** keys to initiate the intermodulation measurement.

The Intermodulation measurement result should look like the next figure. The intermodulation products are graphically displayed in the graph window. The absolute and relative power levels and lower and upper power spectral density levels are shown in the text window.

Figure 2-22 Intermodulation Measurement Result



- Step 6.** Press the **Meas Setup, More (1 of 2)** keys to check what keys are available to change the measurement parameters from the default condition.

If you have a problem, and get an error message, see [“Interpreting Common Error Codes”](#) on page 183 or the “Instrument Messages and Functional Tests” manual.

Troubleshooting Hints

Intermodulation distortion (IMD) measurements can reveal degraded or defective parts in the transmitter section of the UUT. Check the following if further intermodulation distortion occurs:

- Faulty DC power supply control of the transmitter power amplifier.
- RF power controller of the pre-power amplifier stage.
- I/Q control of the baseband stage.
- Reduction in the gain and output power level of the amplifier due to a degraded gain control and/or increased distortion.
- Degradation of the amplifier linearity and other performance characteristics.

Power amplifiers are one of the final stage elements of a base or mobile transmitter and play a critical part in meeting the important power and spectral efficiency specifications. Measuring the spectral response of the amplifiers to complex wideband signals is crucial to linking amplifier linearity and other performance characteristics to the stringent system specifications.

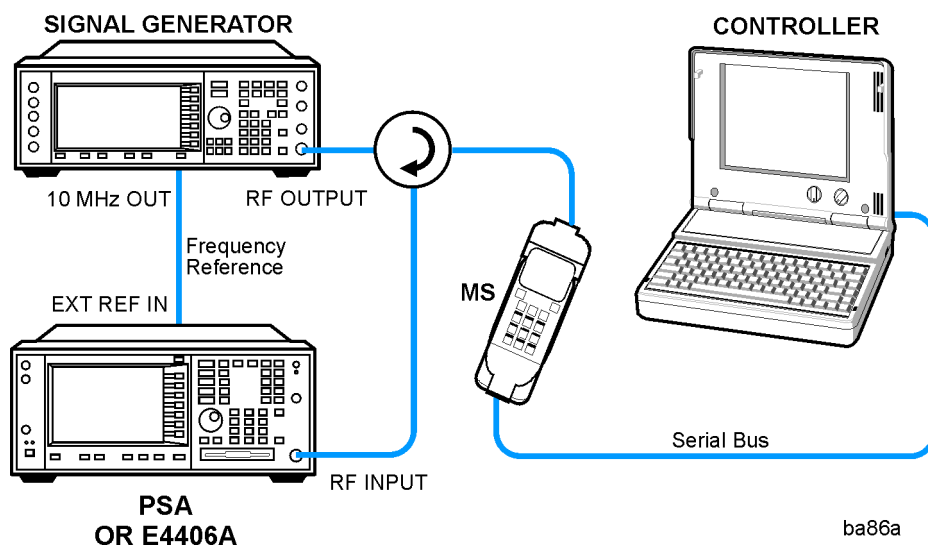
Modulation Accuracy (Composite EVM) Measurements

This section explains how to make the modulation accuracy (composite EVM) measurement on a W-CDMA (3GPP) mobile station. Modulation accuracy is the ratio of the correlated power in a multi coded channel to the total signal power.

Configuring the Measurement System

For configuring the measurement system, the mobile station (MS) under test has to be set to transmit the RF power remotely through the system controller. This transmitting signal is connected to the instruments RF input port. Connect the equipment as shown.

Figure 2-23 Modulation Accuracy Measurement System



1. Using the appropriate cables, adapters, and circulator, connect the output signal of the MS to the RF input of the instrument.
2. Connect the base transmission station simulator or signal generator to the MS through the circulator to initiate a link constructed with the sync and pilot channels, if required.
3. Connect a BNC cable between the 10 MHz OUT port of the signal generator and the EXT REF IN port of the instrument.
4. Connect the system controller to the MS through the serial bus cable to control the MS operation.

Setting the MS

From the base transmission station simulator and/or the system controller, perform all of the call acquisition functions required for the MS to transmit the RF power as follows:

Frequency: 1,920 MHz (Channel Number: $5 \times 1,920 = 9,600$)

Physical Channels: A coded signal with the DPCCH and at least one DPDCH is required to make a composite EVM measurement on a W-CDMA UL signal. (A W-CDMA DL signal must contain either the SCH or the CPICH.)

Scramble Code: 0

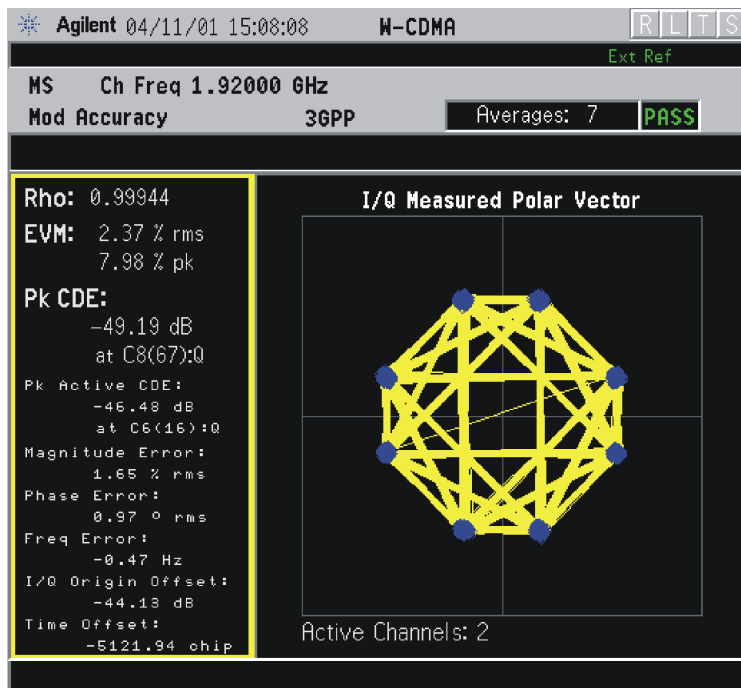
Output Power: -20 dBm (at analyzer input)

Measurement Procedure

- Step 1.** Press the **Preset** key to preset the instrument.
- Step 2.** Press the **MODE, More (1 of 2), W-CDMA (3GPP)** keys to enable the W-CDMA (3GPP) measurements.
- Step 3.** Press the **Mode Setup, Radio, Device** to toggle the device to **MS**.
- Step 4.** Press the **FREQUENCY Channel, 1920, MHz** keys to set the center frequency to 1.920 GHz.
- Step 5.** Press the **MEASURE, More (1 of 2), Mod Accuracy (Composite EVM)** keys to initiate the modulation accuracy (composite EVM) measurement.

The Mod Accuracy: I/Q Measured Polar Vector measurement result should look like [Figure 2-24](#).

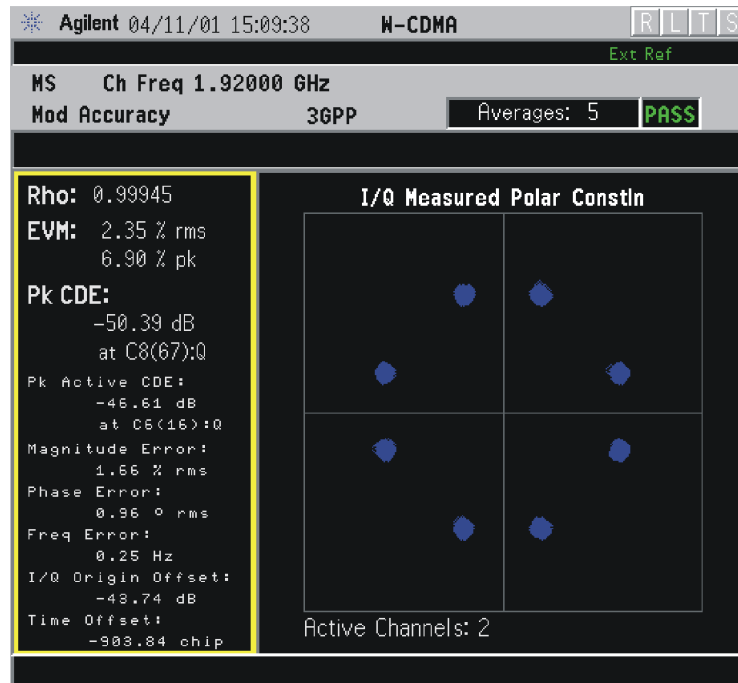
Figure 2-24 Modulation Accuracy Measurement Result - Polar Graph (Default) View



The modulation constellation is shown, along with summary data for Rho, EVM, Peak Code Domain Error, and phase and magnitude errors. For more information see “[Modulation Accuracy \(Composite EVM\) Measurements](#)” on page 97 in the Concepts section of this manual.

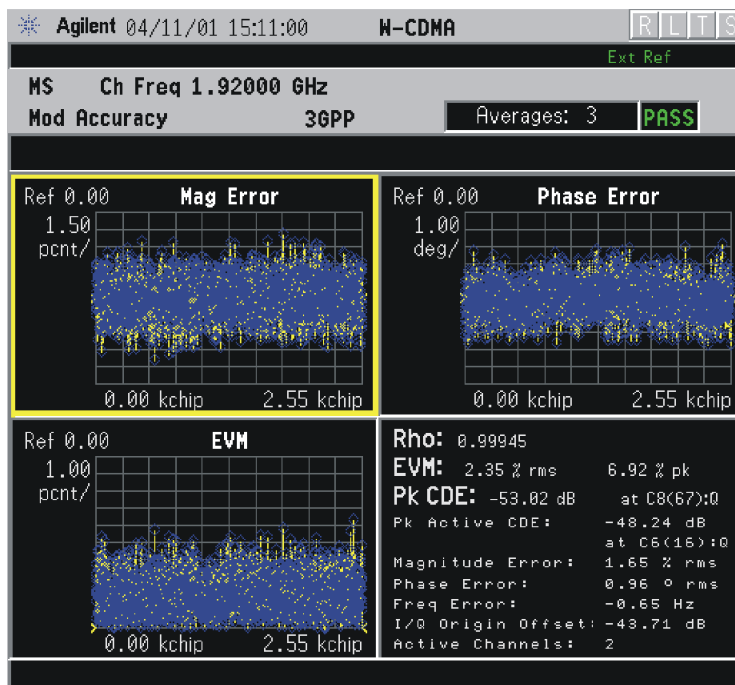
Step 6. Press the **View/Trace, I/Q Measured Polar Constln** keys to display a combination view of the I/Q measured polar constellation graph window and the modulation summary result window.

Figure 2-25 Modulation Accuracy Measurement Result - Polar Constellation View



Step 7. Press the **View/Trace, I/Q Error (Quad View)** keys to display a combination view of the magnitude error, phase error, and EVM graph windows, and the modulation summary result window.

Figure 2-26 Modulation Accuracy Measurement Result - I/Q Error Quad View



If you have a problem, and get an error message, see “[Interpreting Common Error Codes](#)” on page 183 or the “Instrument Messages and Functional Tests” manual.

For more information, see “[Modulation Accuracy \(Composite EVM\) Measurements](#)” on page 97 in the Concepts section of this manual.

Troubleshooting Hints

A poor phase error often indicates a problem with the I/Q baseband generator, filters, and/or modulator in the transmitter circuitry of the UUT. The output amplifier in the transmitter can also create distortion that causes unacceptably high phase error. In a real system, a poor phase error will reduce the ability of a receiver to correctly demodulate the received signal, especially in marginal signal conditions.

If the error code 503 “Can not correlate to input signal” is shown, it means that your measurement has failed to find any active channels due to the lack of correlation with the input signal. The input signal level and/or scramble code may need to be adjusted to obtain correlation.

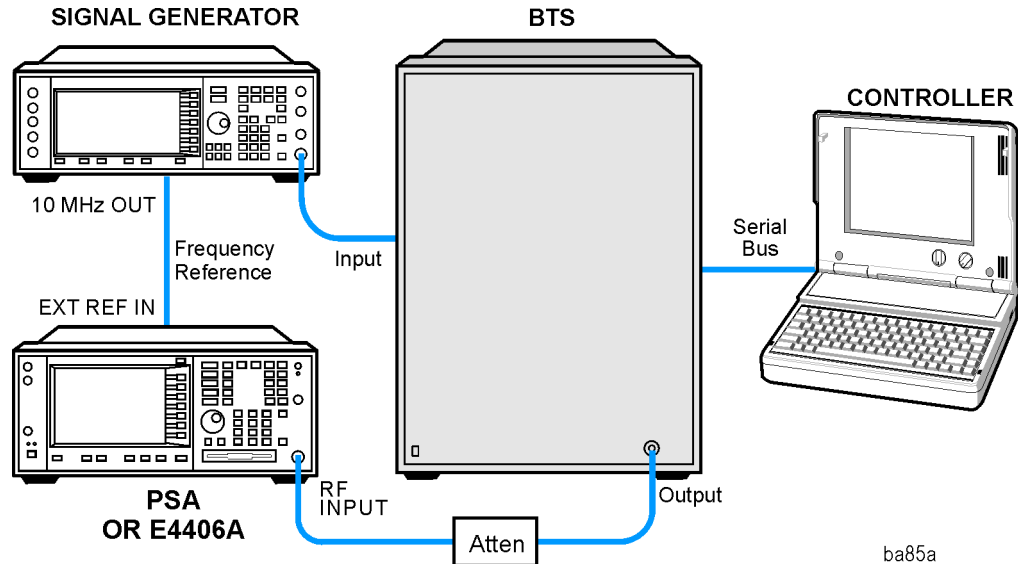
Multi Carrier Power Measurements

This section explains how to make the multi carrier power measurement on a W-CDMA (3GPP) base transmission station. Multi carrier power measures the in-channel and out-of-channel power of the intermodulation products from two or more carriers that are present at the same time.

Configuring the Measurement System

The base transmission station (BTS) under test has to be set to transmit the one RF carrier remotely through the system controller. This transmitting signal is connected to the instruments RF input port. Connect the equipment as shown.

Figure 2-27 Multi Carrier Power Measurement System



1. Using the appropriate cables and adapters, connect the W-CDMA modulated signal from the signal generator to the amplifier input connector of the BTS.
2. Connect the output signal of the BTS to the RF input port of the instrument, through the attenuator.
3. Connect a BNC cable between the 10 MHz OUT port of the signal generator and the EXT REF IN port of the instrument.
4. Connect the system controller to the BTS through the serial bus cable.

Setting the BTS and W-CDMA Signal Generator

From the system controller, perform all of the call acquisition functions required for the BTS to transmit the RF signal. Set the signal generator to output the 5 MHz offset second carrier signal. Make sure you do not exceed the maximum safe input power to the analyzer.

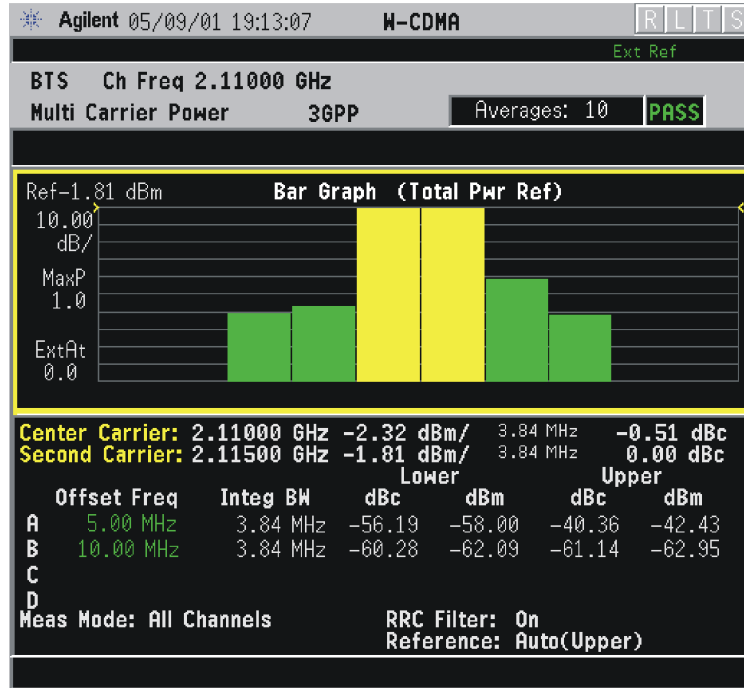
- **BTS (center carrier)**
Frequency: 2,110 MHz (Channel Number: $5 \times 2,110 = 10,550$)
Signal: Test Model 1
Output Power: Minimum output power level
- **Signal Generator (5 MHz offset second carrier)**
Frequency: 2,115 MHz (Channel Number: $5 \times 2,115 = 10,575$)
Signal: Test Model 1
Output Power: Same level to the BTS output power at the BTS antenna output port

Measurement Procedure

- Step 1.** Press the **Preset** key to preset the instrument.
- Step 2.** Press the **Mode, More (1 of 2), W-CDMA (3GPP)** keys to enable the W-CDMA (3GPP) measurements.
- Step 3.** Press the **Mode Setup, Radio, Device** to toggle the device to **BTS**.
- Step 4.** Press the **FREQUENCY Channel, 2110, MHz** keys to set the center carrier to 2.110 GHz.
- Step 5.** Press the **MEASURE, Multi Carrier Power** keys to initiate the multi carrier power measurement.

The Multi Carrier Power: Bar Graph (Total Pwr Ref) measurement result should look like [Figure 2-28 on page 104](#). The bar graph window and the text window show the relative and absolute power levels for each carrier and offset channel.

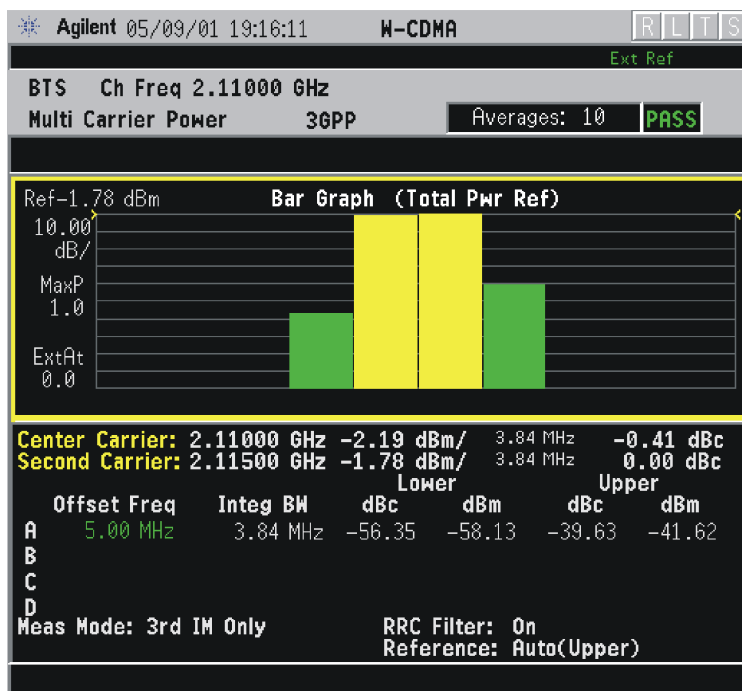
Figure 2-28 Multi Carrier Power Measurement Result - All Channels Mode



- Step 6.** Press the **Meas Setup, 2nd Carrier Offset** keys to make sure that the **+5 MHz** key is highlighted. This means that the second carrier offset is set to +5 MHz relative to the center carrier. You can change the offset frequency when the second carrier frequency is changed.
- Step 7.** Press the **Ref Chan, Upper** keys to change the reference channel control from the automatic mode to the upper carrier (the second carrier in this example). Notice how the displayed measurement results change.

Step 8. Press the **Meas Mode, 3rd IM Only** keys to measure the 3rd order intermodulation products.

Figure 2-29 Multi Carrier Power Measurement Result - 3rd Order IMD Mode



If you have a problem, and get an error message, see [“Interpreting Common Error Codes”](#) on page 183 or the “Instrument Messages and Functional Tests” manual.

Troubleshooting Hints

If there is a frequency channel dependency in the operating characteristics of a multi carrier power amplifier, it might have channel balance problems due to spurious response, distortion, and/or intermodulation products.

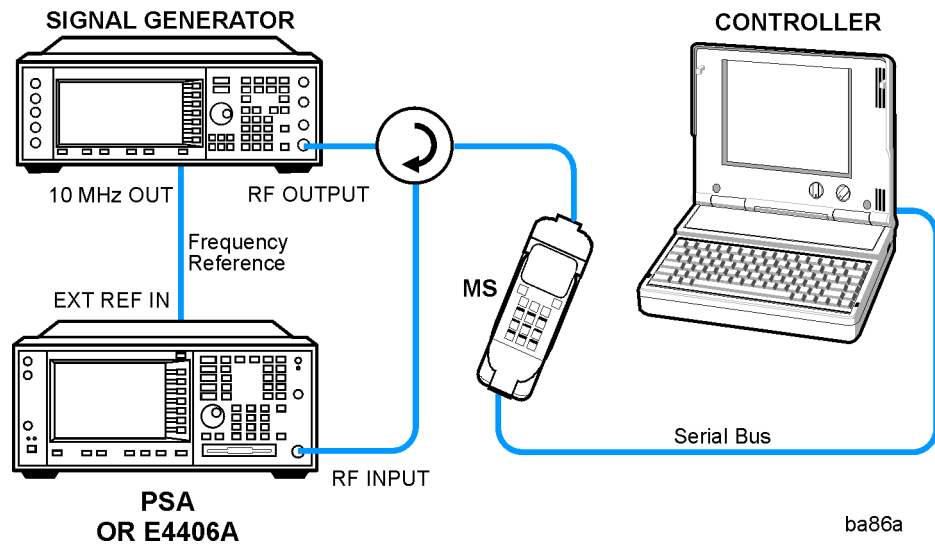
Occupied Bandwidth Measurements

This section explains how to make the occupied bandwidth measurement on a W-CDMA (3GPP) mobile station. The instrument measures power across the band, and then calculates its 99.0% power bandwidth.

Configuring the Measurement System

For configuring the measurement system, the mobile station (MS) under test has to be set to transmit the RF power remotely through the system controller. This transmitting signal is connected to the instruments RF input port. Connect the equipment as shown.

Figure 2-30 Occupied Bandwidth Measurement System



1. Using the appropriate cables, adapters, and circulator, connect the output signal of the MS to the RF input of the instrument.
2. Connect the base transmission station simulator or signal generator to the MS through the circulator to initiate a link constructed with the sync and pilot channels, if required.
3. Connect a BNC cable between the 10 MHz OUT port of the signal generator and the EXT REF IN port of the instrument.
4. Connect the system controller to the MS through the serial bus cable to control the MS operation.

Setting the MS

From the base transmission station simulator and/or the system controller, perform all of the call acquisition functions required for the MS to transmit the RF power as follows:

Frequency: 1,920 MHz (Channel Number: $5 \times 1,920 = 9,600$)

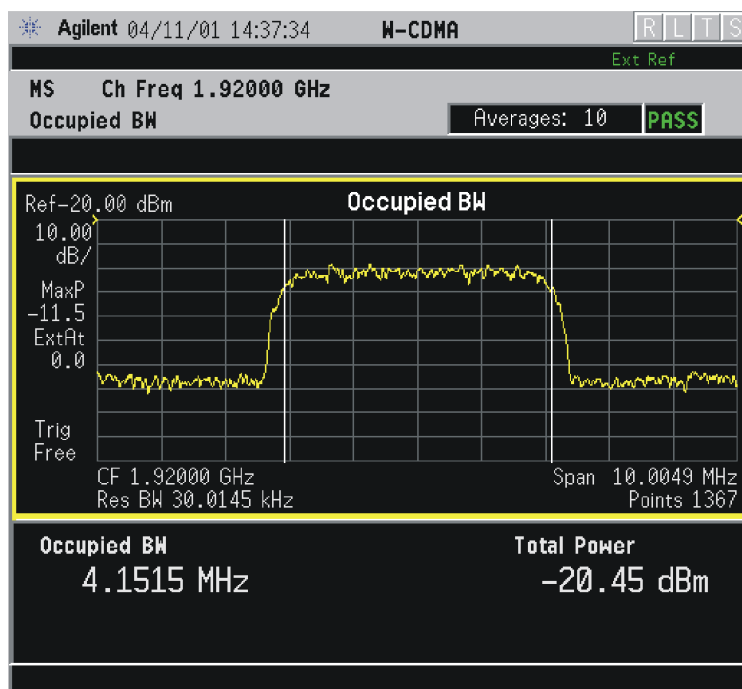
Output Power: +21 dBm with Power Class 4 (or other power level for the MS)

Measurement Procedure

- Step 1.** Press the **Preset** key to preset the instrument.
- Step 2.** Press the **MODE, More (1 of 2), W-CDMA (3GPP)** keys to enable the W-CDMA (3GPP) measurements.
- Step 3.** Press the **Mode Setup, Radio, Device** to toggle the device to **MS**.
- Step 4.** Press the **FREQUENCY Channel, 1920, MHz** keys to set the center frequency to 1.920 GHz.
- Step 5.** Press the **MEASURE, Occupied BW** keys to initiate the occupied bandwidth measurement.

The Occupied BW measurement result should look like the [Figure 2-31](#).

Figure 2-31 Occupied Bandwidth Measurement Result



If you have a problem, and get an error message, see “[Interpreting Common Error Codes](#)” on page 183 or the “Instrument Messages and Functional Tests” manual.

Troubleshooting Hints

Any distortion such as harmonics or intermodulation, for example, produces undesirable power outside the specified bandwidth.

Shoulders on either side of the spectrum shape indicate spectral regrowth and intermodulation. Rounding or sloping of the top shape can indicate filter shape problems.

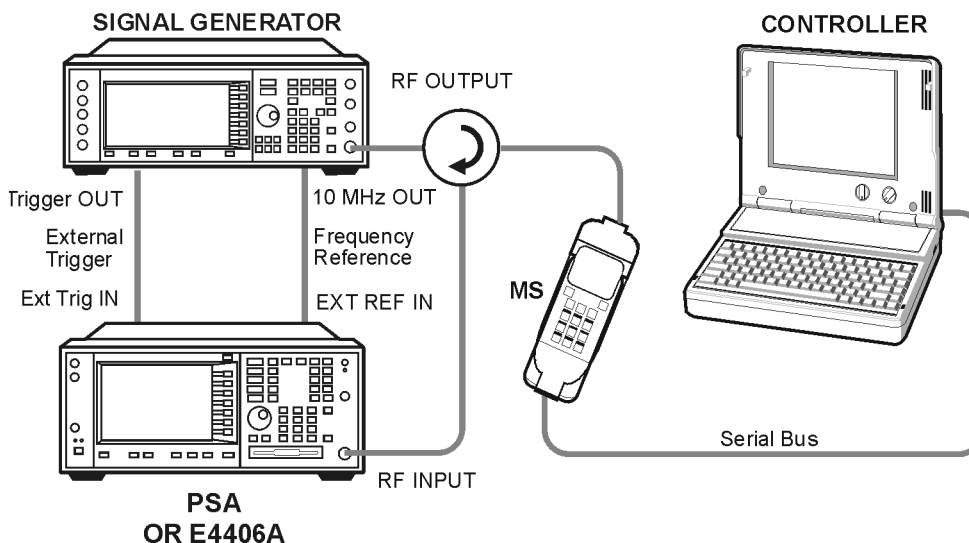
Power Control Measurements

This section explains how to make power control measurements on W-CDMA mobile stations. Power control measurements characterize the ability of a mobile station to vary the power levels of a digitally modulated signal, as directed by the base station. There are three selections of measurement type; Slot Power to monitor the power steps, PRACH Power to verify the PRACH preambles and PRACH message power levels, and Slot Phase for UE phase discontinuity.

Configuring the Measurement System

For configuring the measurement system, the mobile station (MS) under test has to be set to transmit the RF power remotely through the system controller. This transmitting signal is connected to the instruments RF input port. Connect the equipment as shown.

Figure 2-32 Power Control Measurement System



1. Using the appropriate cables, adapters, and circulator, connect the output signal of the MS to the RF input of the instrument.
2. Connect the base transmission station simulator or signal generator to the MS through the circulator to initiate a link constructed with the sync and pilot channels, if required.
3. Connect a BNC cable between the 10 MHz OUT port of the signal generator and the EXT REF IN port of the instrument.
4. Connect a trigger signal from the signal generator or system controller and the EXT TRIG IN port of the instrument.

5. Connect the system controller to the MS through the serial bus cable to control the MS operation.

Setting the MS

From the UE transmission station simulator and/or the system controller, perform all of the call acquisition and power control functions required for the MS to transmit the RF power as follows:

Frequency: 1.000 GHz

Physical Channels: DPCCH with one or more DPDCH

NOTE

This example shows a signal with 1 dB power steps across the frame

Output Power: -15 dBm (at analyzer input) peak

Measurement Procedure

- Step 1.** Press the **Preset** key to preset the instrument.
- Step 2.** Press the **MODE, More (1 of 2), W-CDMA (3GPP)** keys to enable the W-CDMA (3GPP) measurements.
- Step 3.** Press the **Mode Setup, Radio, Device** to toggle the device to **MS**.
- Step 4.** Press the **Mode Setup, Trigger** to select the **EXT Front** or **EXT Rear** trigger supplied.
- Step 5.** Press the **FREQUENCY Channel, 1000, MHz** keys to set the center frequency to 1.000 GHz.
- Step 6.** Press the **MEASURE, More (1 of 3), More (2 of 3)**, then **Pwr Control** keys to initiate the default power control measurement

The default power control measurement result should look like [Figure 2-33 on page 112](#).

Figure 2-33 Power Control Measurement Result - Default View

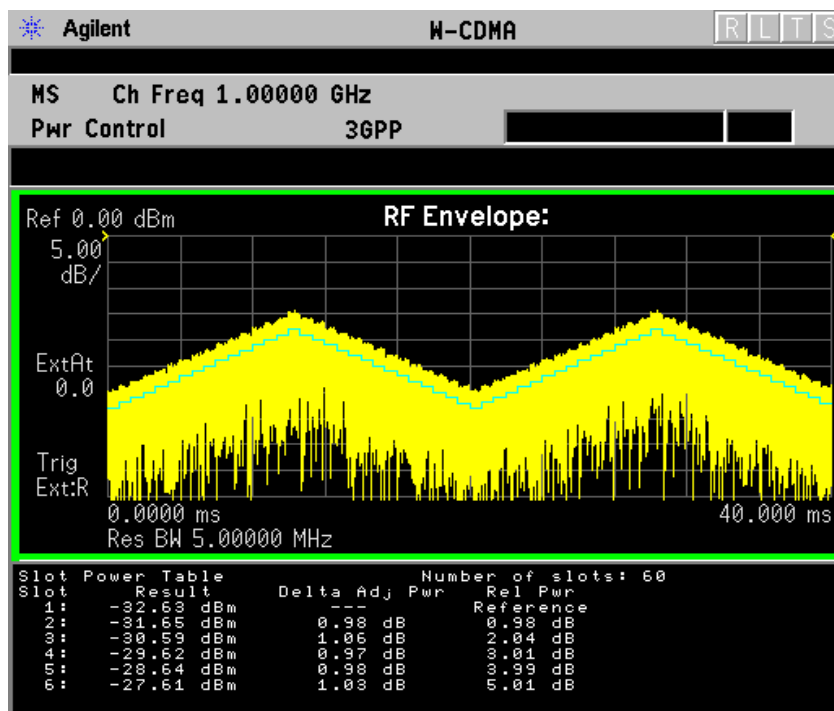


Figure 2-34 Power Control Measurement Result - PRACH Measurement

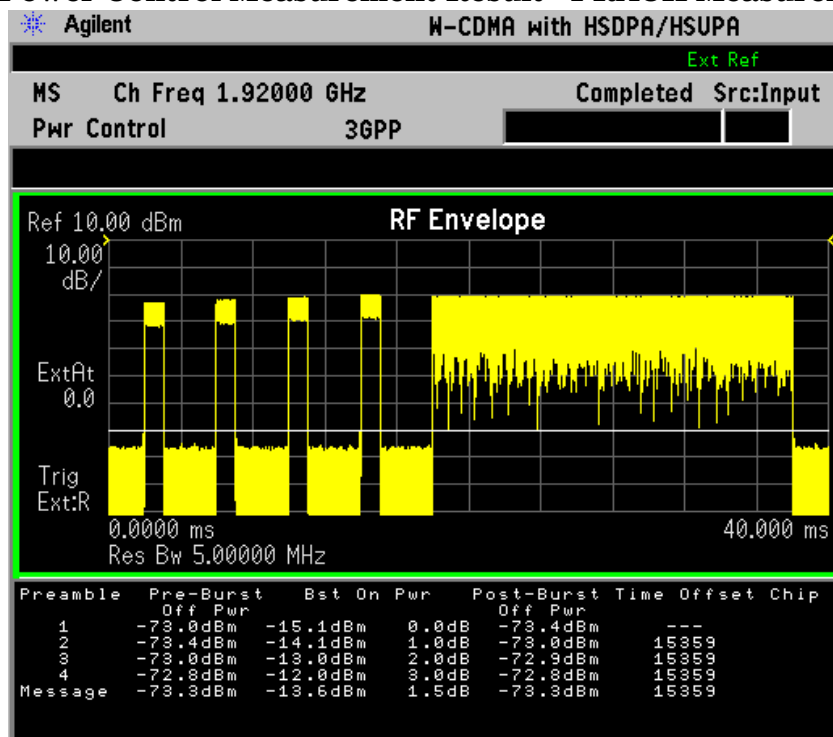
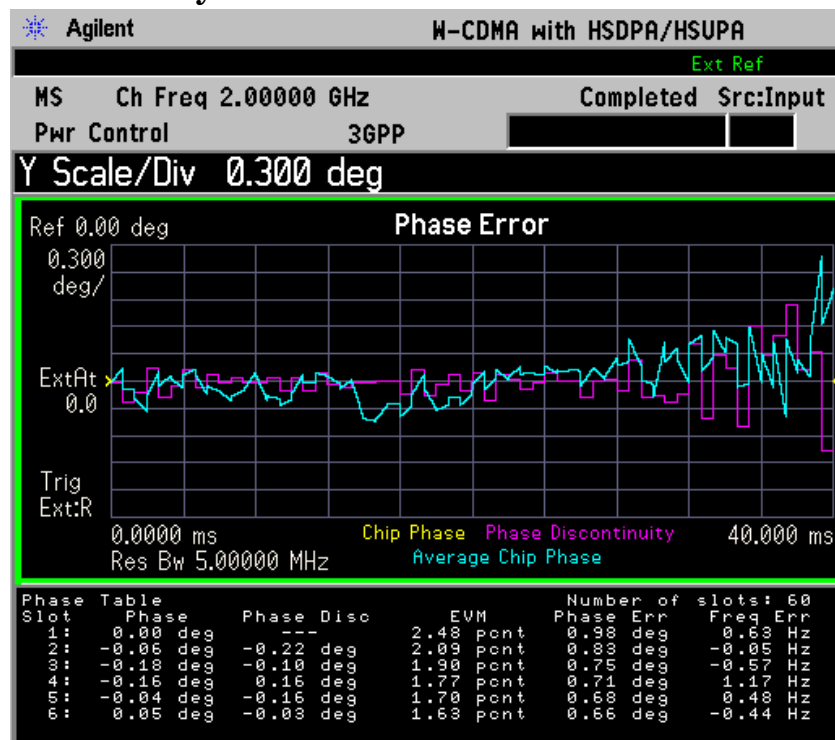


Figure 2-35 Power Control Measurement Result - Slot Phase for UE Phase Discontinuity



Step 7. To make measurements repeatedly, press the **Meas Control**, **Measure** keys to change the Meas Control from **Single** to **Cont**.

If you have a problem, and get an error message, see [“Interpreting Common Error Codes” on page 183](#) or the “Instrument Messages and Functional Tests” manual.

Troubleshooting Hints

If an external attenuator is used, be sure to use the **Ext RF Atten** key to include the attenuation value in the displayed measurement result.

The power control measurement, along with the power versus time measurement and spectrum measurement, can reveal the effects of degraded or defective parts in the transmitter section of the UUT. The following are areas of concern which can contribute to performance degradation:

- DC power supply control of the transmitter power amplifier, RF power control of the pre-power amplifier stage, and/or I/Q control of the baseband stage.
- Gain and output power levels of the power amplifier, caused by degraded gain control and/or increased distortion.
- Amplifier linearity.

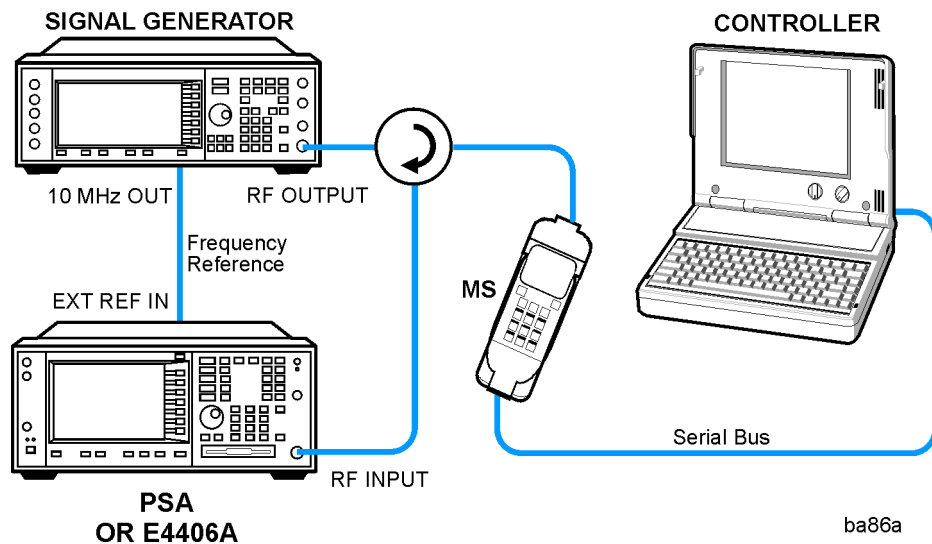
Power Statistics CCDF Measurements

This section explains how to make the Power Statistics Complementary Cumulative Distribution Function (Power Stat CCDF) measurement on a W-CDMA (3GPP) mobile station. Power Stat CCDF curves characterize the higher level power statistics of a digitally modulated signal.

Configuring the Measurement System

For configuring the measurement system, the mobile station (MS) under test has to be set to transmit the RF power remotely through the system controller. This transmitting signal is connected to the instrument's RF input port. Connect the equipment as shown.

Figure 2-36 Power Statistics (CCDF) Measurement System



1. Using the appropriate cables, adapters, and circulator, connect the output signal of the MS to the RF input of the instrument.
2. Connect the base transmission station simulator or signal generator to the MS through the circulator to initiate a link constructed with the sync and pilot channels, if required.
3. Connect a BNC cable between the 10 MHz OUT port of the signal generator and the EXT REF IN port of the instrument.
4. Connect the system controller to the MS through the serial bus cable to control the MS operation.

Setting the MS

From the base transmission station simulator and/or the system controller, perform all of the call acquisition functions required for the MS to transmit the RF power as follows:

Frequency: 1,920 MHz (Channel Number: $5 \times 1,920 = 9,600$)

Physical Channels: DPCCH with one or more DPDCH

Output Power: -20 dBm (at analyzer input)

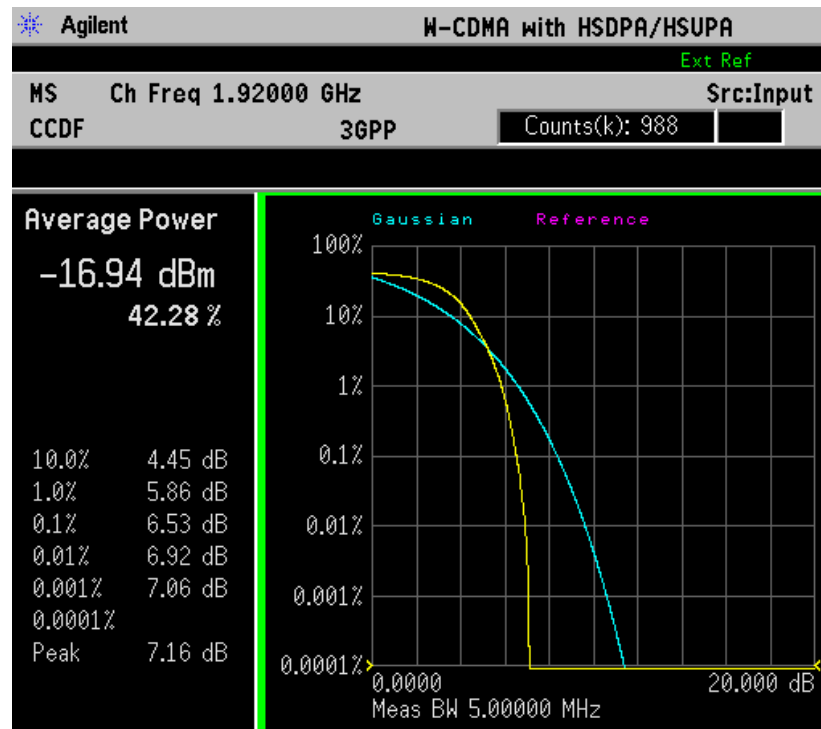
Measurement Procedure

- Step 1.** Press the **Preset** key to preset the instrument.
- Step 2.** Press the **MODE, More (1 of 2), W-CDMA (3GPP)** keys to enable the W-CDMA (3GPP) measurements.
- Step 3.** Press the **Mode Setup, Radio, Device** to toggle the device to **MS**.
- Step 4.** Press the **FREQUENCY Channel, 1920, MHz** keys to set the center frequency to 1.920 GHz.
- Step 5.** Press the **MEASURE, More (1 of 2), Power Stat CCDF** keys to initiate the power statistics CCDF measurement.

The CCDF measurement result should look like the next figure.

Figure 2-37

Power Statistics CCDF Result



Step 6. To make continuous measurements, press **Meas Control, Measure, Cont.**

If you have a problem, see [“Interpreting Common Error Codes”](#) on page 183 or the “Instrument Messages and Functional Tests” manual.

Troubleshooting Hints

The power statistics CCDF measurement can contribute in setting the signal power specifications for design criteria for systems, amplifiers, and other components. For example, it can help determine the optimum operating point to adjust each code timing for appropriate peak/average power ratio throughout the wide channel bandwidth of the transmitter for a W-CDMA (3GPP) system.

As this measurement is a new method, there will be some correlations between CCDF curve degradation and digital radio system measurement parameters such as BER, FER, code domain power, and ACPR. Some studies will help set standards for radio design by specifying the maximum allowed CCDF curve degradation for specific systems.

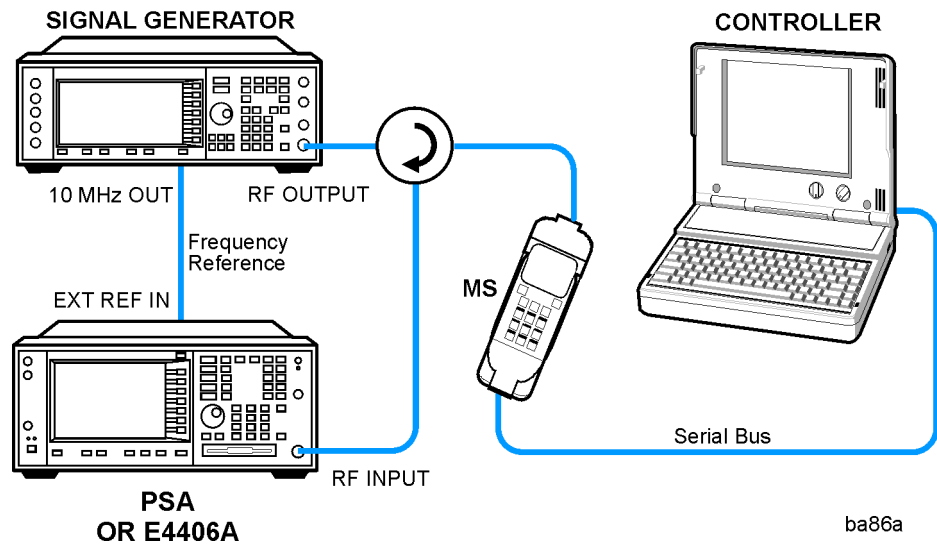
Power versus Time (PvT) Mask Measurements

This section explains how to make a PvT mask measurement on a W-CDMA (3GPP) mobile station. PvT mask measurements indicate whether the timing of the transmission of the digitally modulated signal is consistent with the 3GPP standards.

Configuring the Measurement System

For configuring the measurement system, the mobile station (MS) under test has to be set to transmit the RF power remotely through the system controller. This transmitting signal is connected to the instruments RF input port. Connect the equipment as shown.

Figure 2-38 PvT Mask Measurement System



1. Using the appropriate cables, adapters, and circulator, connect the output signal of the MS to the RF input of the instrument.
2. Connect the base transmission station simulator or signal generator to the MS through the circulator to initiate a link constructed with the sync and pilot channels, if required.
3. Connect a BNC cable between the 10 MHz OUT port of the signal generator and the EXT REF IN port of the instrument.
4. Connect the system controller to the MS through the serial bus cable to control the MS operation.

Setting the MS

From the base transmission station simulator and/or the system controller, perform all of the call acquisition functions required for the MS to transmit the RF power as follows:

Frequency: 1,920 MHz (Channel Number: $5 \times 1,920 = 9,600$)

Physical Channels: DPCCH with one or more DPDCH

Scramble Code: 0

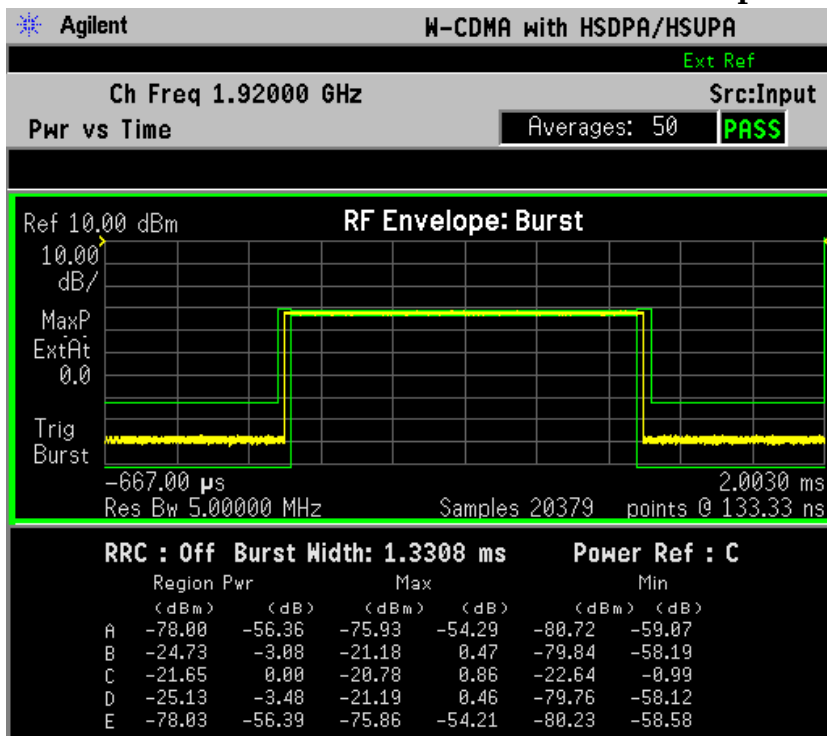
Output Power: -20 dBm (at analyzer input)

Measurement Procedure

- Step 1.** Press the **Preset** key to preset the instrument.
- Step 2.** Press the **MODE**, **More (1 of 2)**, **W-CDMA (3GPP)** keys to enable the W-CDMA (3GPP) measurements.
- Step 3.** Press the **Mode Setup**, **Radio**, **Device** to toggle the device to **MS**.
- Step 4.** Press the **FREQUENCY Channel**, **1920**, **MHz** keys to set the center frequency to 1.920 GHz.
- Step 5.** Press the **MEASURE**, **More (1 of 3)**, **More (2 of 3)**, **Pwr vs Time** keys to initiate the Power versus Time Mask measurement. The measurement result should look like [Figure 2-39](#).

Figure 2-39

Power Vs Time Measurement Result - RF Envelope View



Step 6. To make measurements repeatedly, press the **Meas Control**, **Measure** keys to change the Meas Control from **Single** to **Cont**.

If you have a problem, and get an error message, see [“Interpreting Common Error Codes” on page 183](#) or the “Instrument Messages and Functional Tests” manual.

Troubleshooting Hints

This power versus time measurement can reveal degraded or defective parts in the transmitter section of the UUT. The following examples are those areas to be checked further.

- Some faults in the DC power supply control of the transmitter power amplifier, RF power controller of the pre-power amplifier stage, or I/Q control of the baseband stage
- Some degradation in the gain and output power level of the amplifier due to the degraded gain control and/or increased distortion
- Some degradation of the amplifier linearity and other performance characteristics

Power amplifiers are one of the final stage elements of a base or mobile transmitter and are a critical part of meeting the important power and spectral efficiency specifications. Since ACPR measures the spectral response of the amplifier to a complex wideband signal, it is a key measurement linking amplifier linearity and other performance characteristics to the stringent system specifications.

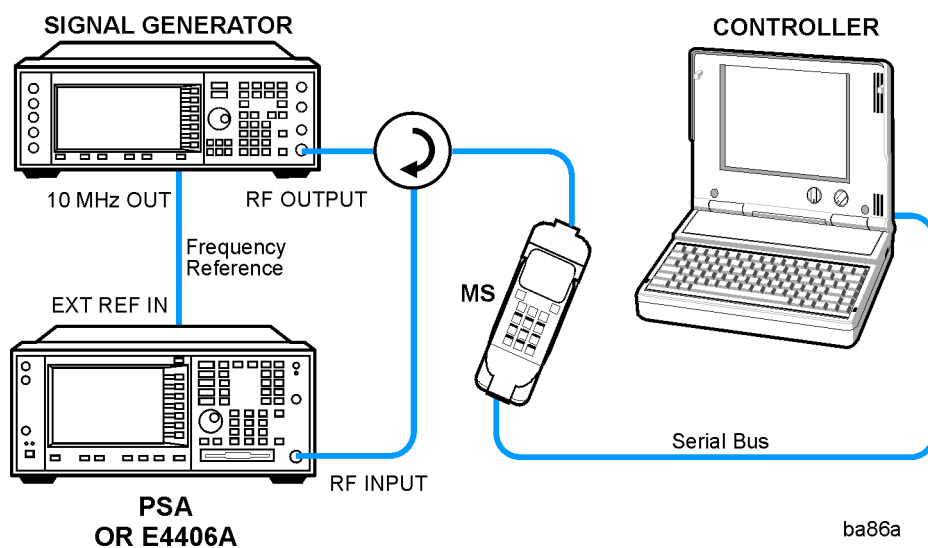
QPSK EVM Measurements

This section explains how to make the QPSK error vector magnitude (EVM) measurement on a W-CDMA (3GPP) mobile station. QPSK EVM is a measure of phase and amplitude modulation quality that relates the performance of the actual signal compared to an ideal signal as a percentage, calculated over the course of the ideal constellation.

Configuring the Measurement System

For configuring the measurement system, the mobile station (MS) under test has to be set to transmit the RF power remotely through the system controller. This transmitting signal is connected to the instrument's RF input port. Connect the equipment as shown.

Figure 2-40 QPSK EVM Measurement System



1. Using the appropriate cables, adapters, and circulator, connect the output signal of the MS to the RF input of the instrument.
2. Connect the base transmission station simulator or signal generator to the MS through the circulator to initiate a link constructed with the sync and pilot channels, if required.
3. Connect a BNC cable between the 10 MHz OUT port of the signal generator and the EXT REF IN port of the instrument.
4. Connect the system controller to the MS through the serial bus cable to control the MS operation.

Setting the MS

From the base transmission station simulator and/or the system controller, perform all of the call acquisition functions required for the MS to transmit the RF power as follows:

Frequency: 1,920 MHz (Channel Number: $5 \times 1,920 = 9,600$)

Physical Channels: DPCCH only

Scramble Code: 0

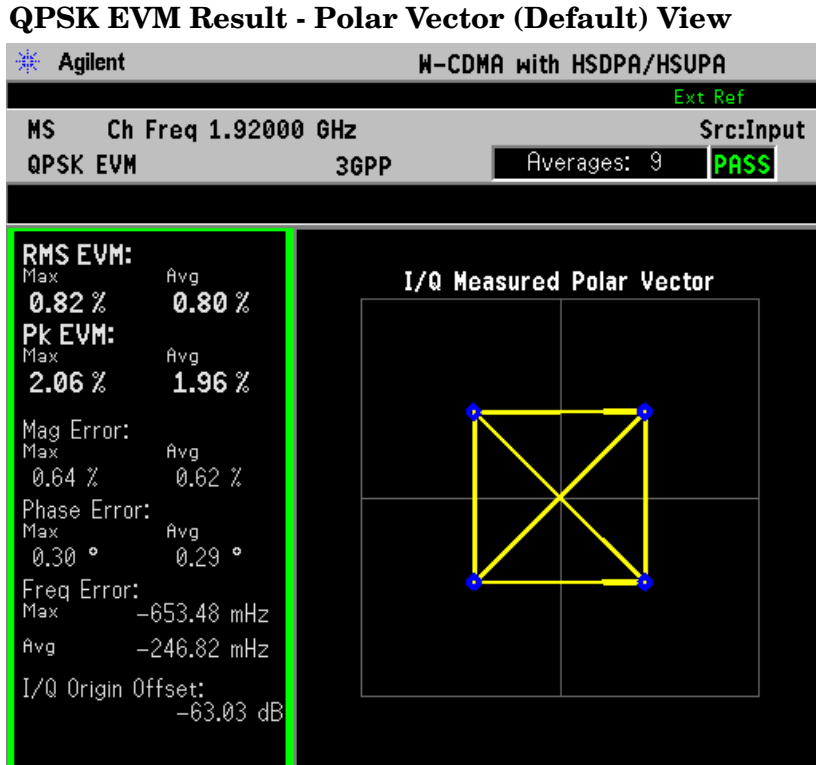
Output Power: -20 dBm (at analyzer input)

Measurement Procedure

- Step 1.** Press the **Preset** key to preset the instrument.
- Step 2.** Press the **MODE, More (1 of 2), W-CDMA (3GPP)** keys to enable the W-CDMA (3GPP) measurements.
- Step 3.** Press the **Mode Setup, Radio, Device** to toggle the device to **MS**.
- Step 4.** Press the **FREQUENCY Channel, 1920, MHz** keys to set the center frequency to 1.920 GHz.
- Step 5.** Press the **MEASURE, More (1 of 2), QPSK EVM** keys to initiate the QPSK EVM measurement.

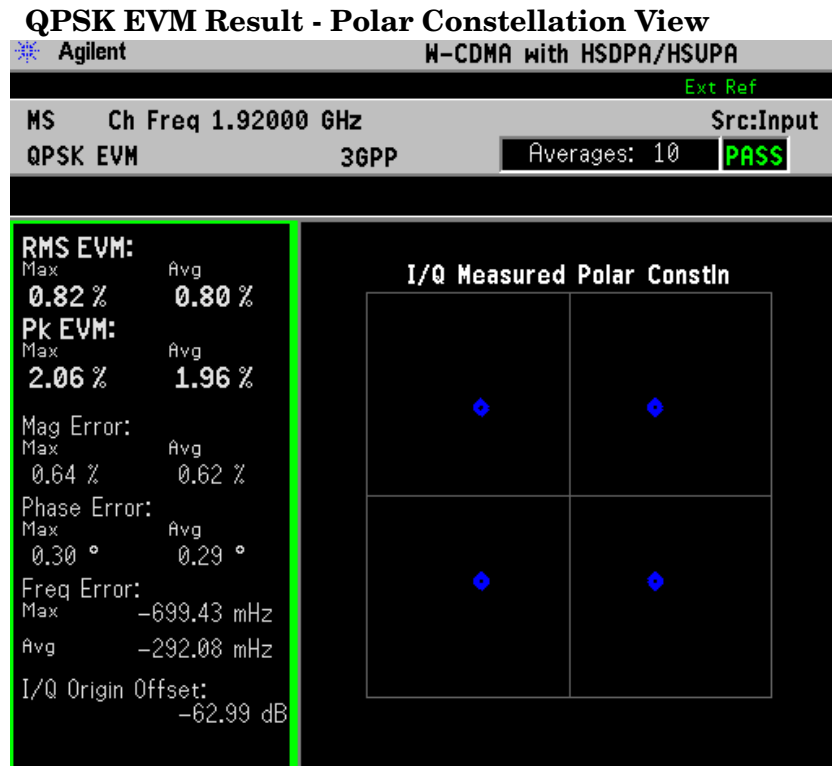
The QPSK EVM: I/Q Measured Polar Vector measurement result should look like Figure 2-41. The measurement values for modulation accuracy are shown in the summary result window.

Figure 2-41



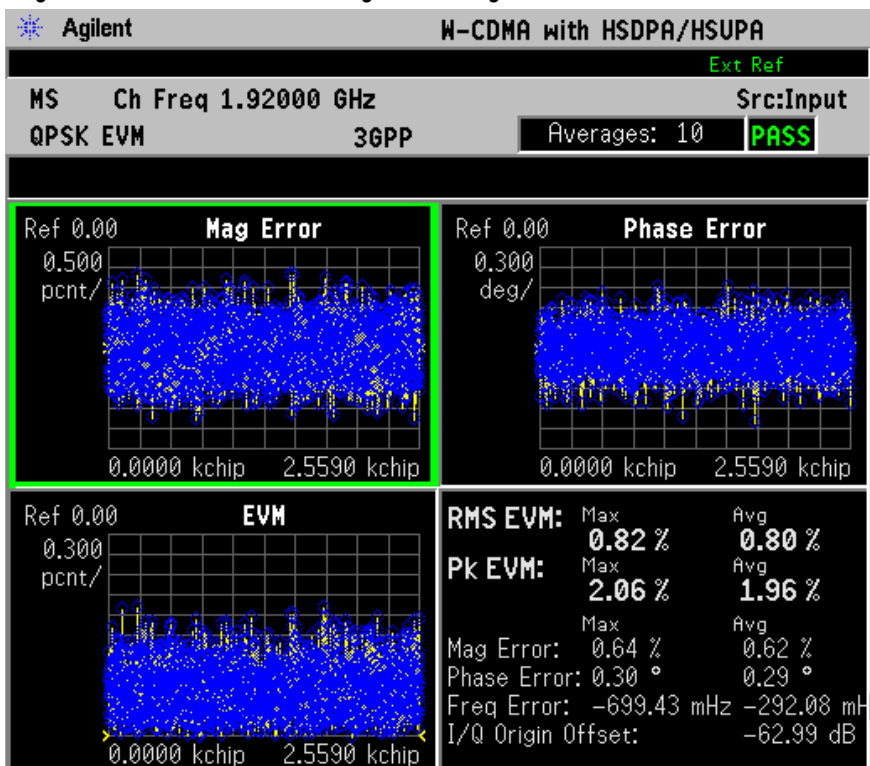
Step 6. Press the **View/Trace, I/Q Measured Polar Constln** keys to display a combination view of the I/Q measured polar constellation graph window and the modulation summary result window.

Figure 2-42



Step 7. Press the **View/Trace, I/Q Error (Quad View)** keys to display a combination view of the magnitude error, phase error, EVM graph windows, and the modulation summary result window.

Figure 2-43 QPSK EVM Result - I/Q Error Quad View



If you have a problem, and get an error message, see [“Interpreting Common Error Codes”](#) on page 183 or the “Instrument Messages and Functional Tests” manual.

Troubleshooting Hints

A poor phase error indicates a problem with the I/Q baseband generator, filters, and/or modulator in the transmitter circuitry of the UUT. The output amplifier in the transmitter can also create distortion that causes unacceptably high phase error. In a real system, a poor phase error will reduce the ability of a receiver to correctly demodulate the received signal, especially in marginal signal conditions.

Spectrum (Frequency Domain) Measurements

This section explains how to make a frequency domain measurement on a W-CDMAcdma20001xEV-DOcellular base station. An adjacent or an interfering signal can also be applied, if desired, during spectrum measurements.

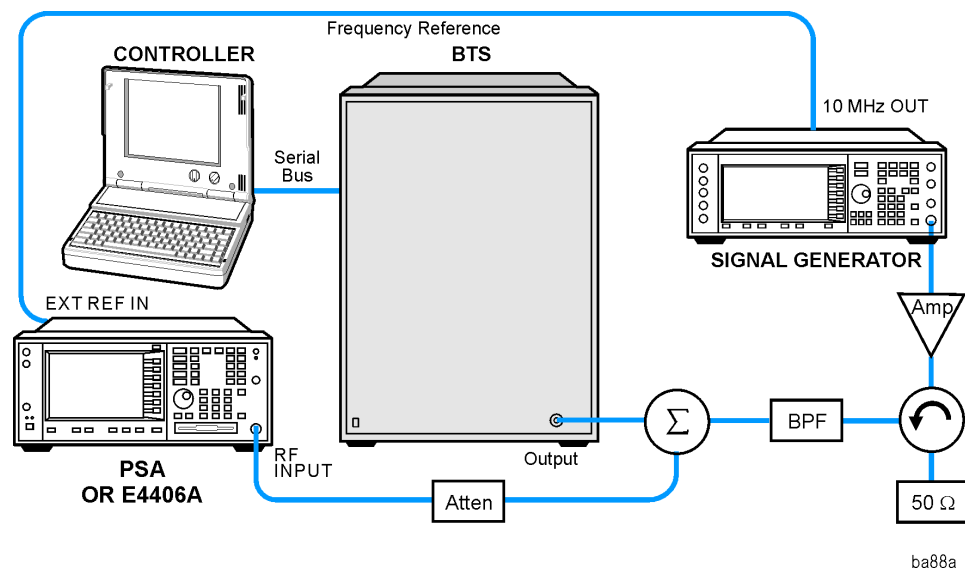
If installed, you may use PSA Option 122, the 80 MHz Bandwidth Digitizer hardware, or PSA Option 140, the 40 MHz Bandwidth Digitizer hardware to perform Waveform measurements of wideband signals using Basic Mode.

Configuring the Measurement System

This example shows a base station (BTS) under test set up to transmit RF power, and being controlled remotely by a system controller. The transmitting signal is connected to the analyzer RF input port. Connect the equipment as shown.

Figure 2-44

Spectrum Measurement System



1. Using the appropriate cables, adapters, and circulator, connect the output signal of the BTS to the RF input of the instrument.
2. Connect the base transmission station simulator or signal generator to the BTS through a circulator to initiate a link constructed with sync and pilot channels, if required.
3. Connect a BNC cable between the 10 MHz OUT port of the signal generator and the EXT REF IN port of the instrument.
4. Connect the system controller to the BTS through the serial bus cable to control the BTS operation.

Setting the BTS

From the base transmission station simulator and the system controller, set up a call using loopback mode to allow the BTS to transmit RF signal.

Measurement Procedure

- Step 1.** Press the **Preset** key to preset the instrument.
- Step 2.** Press the **MODE**, GSM with EDGEBasic1xEV-DO keys to enable the GSM with EDGEBasic1xEV-DO Mode measurements.
- Step 3.** To set the measurement center frequency press the **FREQUENCY Channel** key, enter a numerical frequency using the front-panel keypad, and complete the entry by selecting a units key, like **MHz**.
- Step 4.** Press the **SPAN** key, enter a numerical span using the front-panel keypad, and press the **MHz** key to set the measurement span in MHz.
- Step 5.** Press the **MEASURE** to initiate the spectrum measurement, which is the default measurement for GSM with EDGEBasic1xEV-DO.

NOTE

A display with both a Spectrum window and an I/Q Waveform window will appear when you activate a Spectrum measurement. The active window is outlined in green. Changes to **FREQUENCY**, **Span**, or **Amplitude** settings will affect only the active window. Use the **Next Window** key to select a different window, and the **Zoom** key to enlarge a window.

The default display shows both **Current** (yellow trace) and **Average** (blue trace) data. To make viewing the display easier, you can view either the **Current** trace or **Average** separately.

- Press **Trace/View**, **Trace Display**, and select the trace(s) desired for display.

Figure 2-45 Spectrum Measurement - Spectrum and I/Q Waveform (Default View)

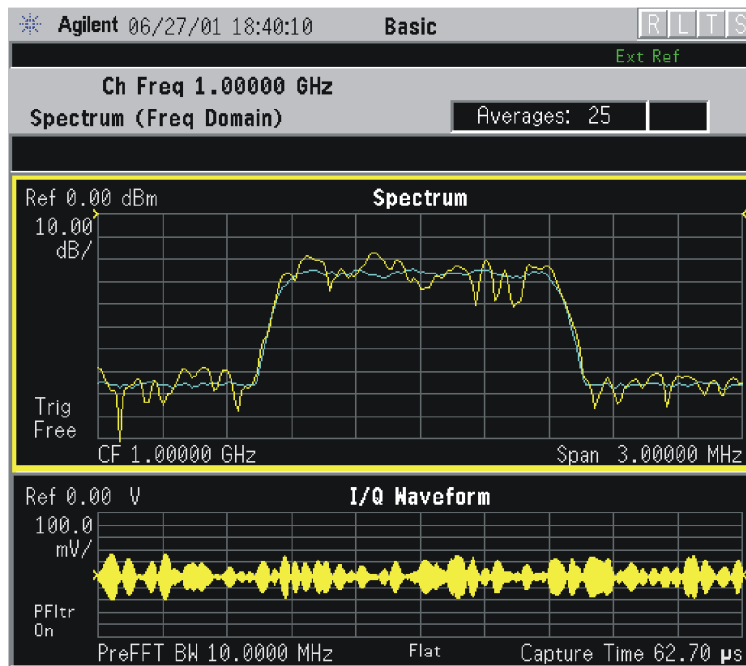


Figure 2-46 Spectrum Measurement - Spectrum and I/Q Waveform (Default) View

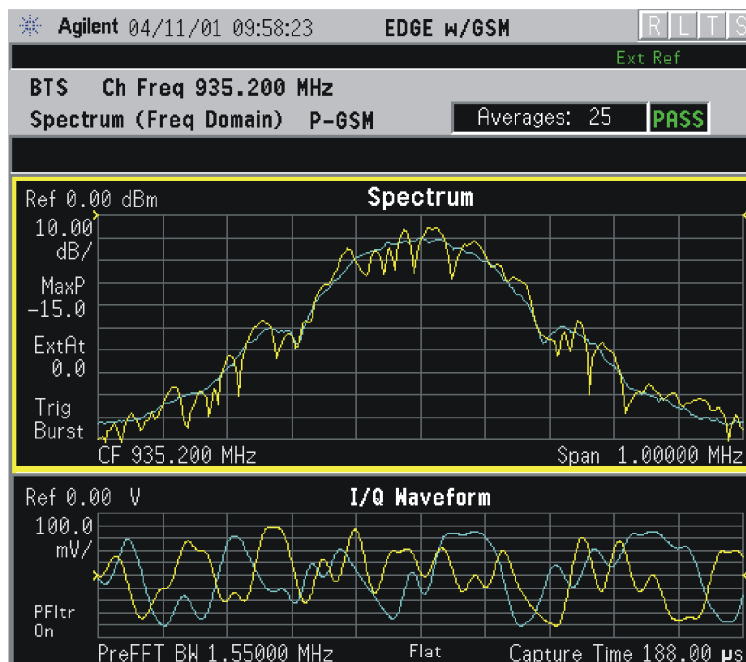


Figure 2-47 Spectrum Measurement - Spectrum and I/Q Waveform (Default View)

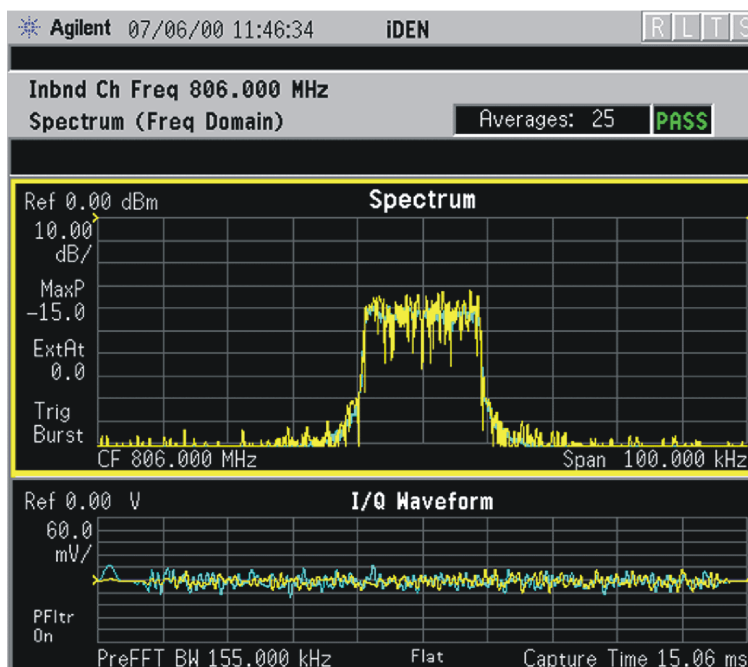
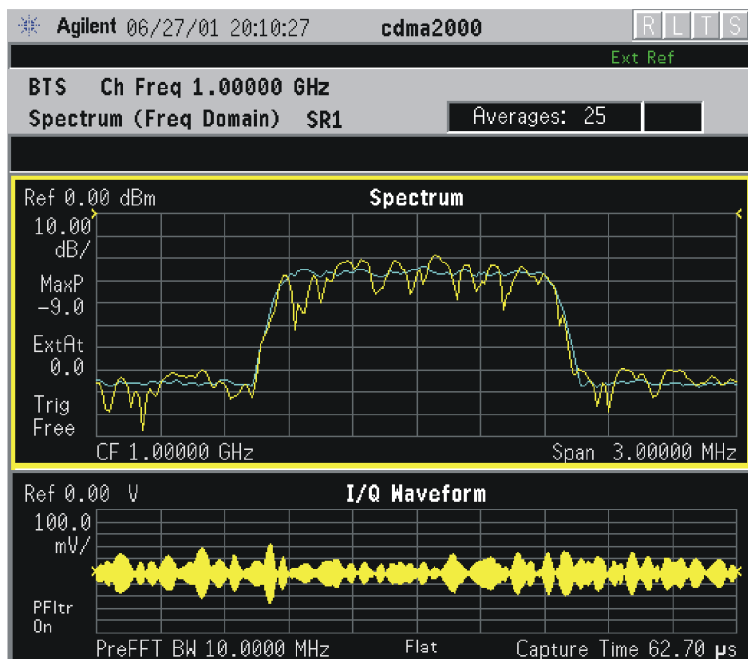


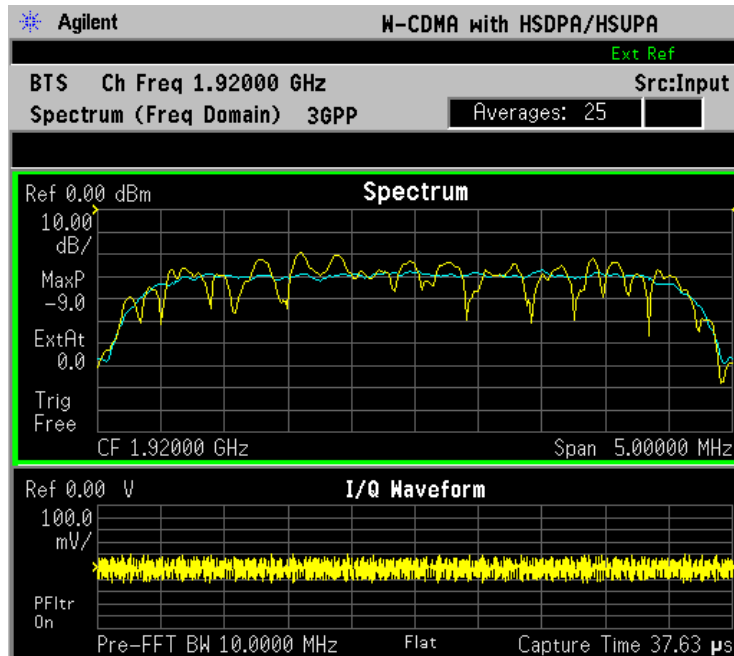
Figure 2-48 Spectrum Measurement - Spectrum and I/Q Waveform (Default View)



*Meas Setup: Span = 3.000 MHz, Capture Time = 62.70 μs,
Others = Factory default settings

*Input signal: -10.00 dBm, Pilot channel of SR1, cdma2000 Rev 8

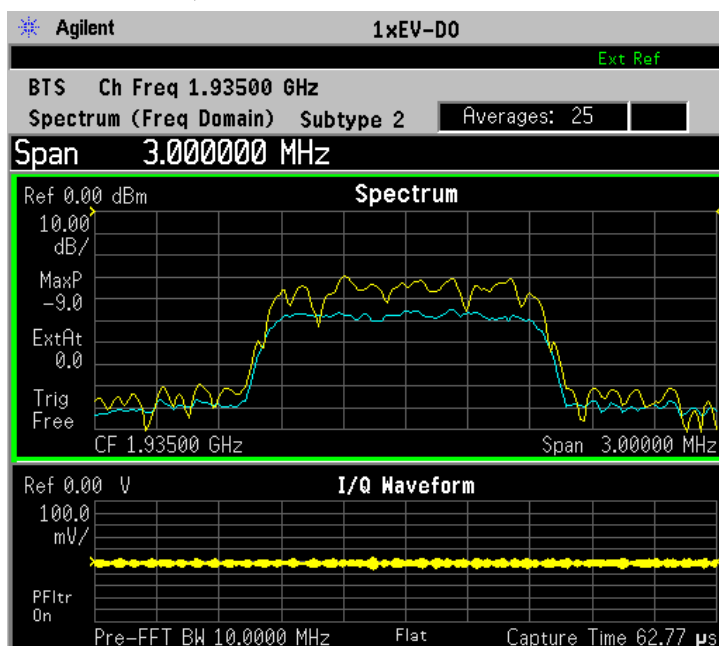
Figure 2-49 Spectrum Measurement - Spectrum and I/Q Waveform (Default View)



*Meas Setup: Span = 5.000 MHz,
Others = Factory default settings

*Input signals: -10.00 dBm, PCCPCH + SCH

Figure 2-50 Spectrum Measurement - Spectrum and I/Q Waveform (Default View)



*Meas Setup: Span = 3.000 MHz, Capture Time = 62.70 μs,
Others = Factory default settings

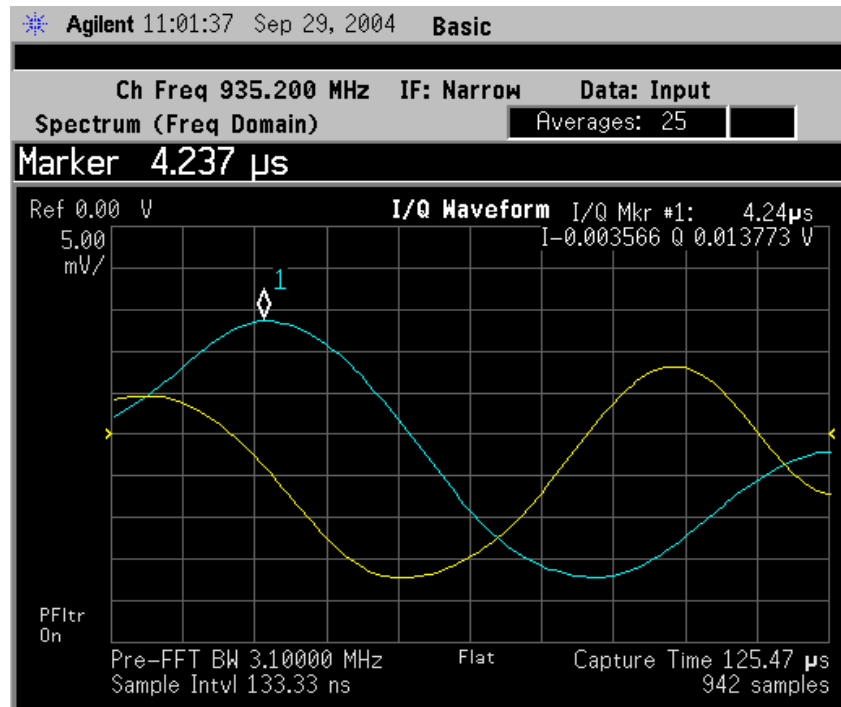
*Input signal: -10.00 dBm, Pilot channel, 1xEV-DO

The spectrum measurement result should look like the above figure. The measurement result values are shown in the summary result window.

Step 6. Press the **View/Trace** key to display a menu allowing selection of another measurement result display including the following:

- **Spectrum** - Provides a combination view of the spectrum graph in parameters of power versus frequency with semi-log graticules, and the I/Q waveform graph in parameters of voltage and time. Changes to frequency span or power will sometimes affect data acquisition. This is equivalent to changing the selected window with the **Next** key.
- **Spectrum (Time Domain) I/Q Waveform** - (Key for PSA only) This graph is shown below the Spectrum graph in the default dual-window display. I/Q Waveform provides a view of the I/Q waveform in parameters of voltage versus time in linear scale. Changes to sweep time or resolution bandwidth can affect data acquisition.

Figure 2-51 Spectrum (Time Domain) Measurement - I/Q Waveform Result



- **Spectrum Linear** - (for E4406A) Provides a view of the spectrum graph in parameters of voltage versus frequency in linear scale. Changes to frequency span or voltage can affect data acquisition.

Figure 2-52 Spectrum Measurement - Linear Spectrum View (for E4406A)

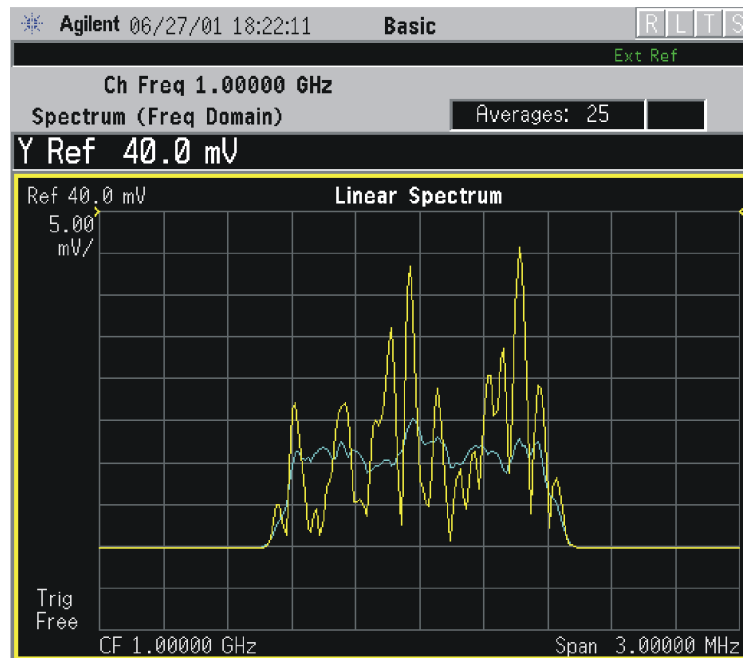
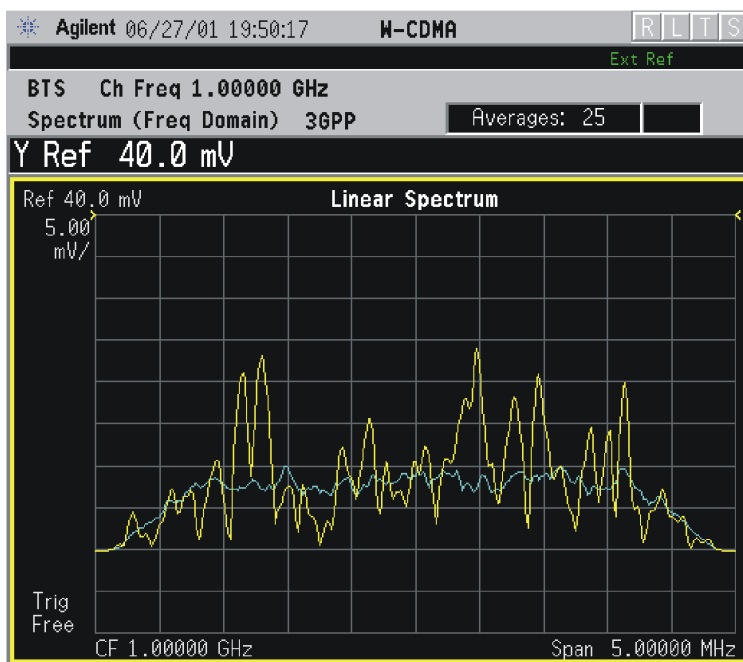


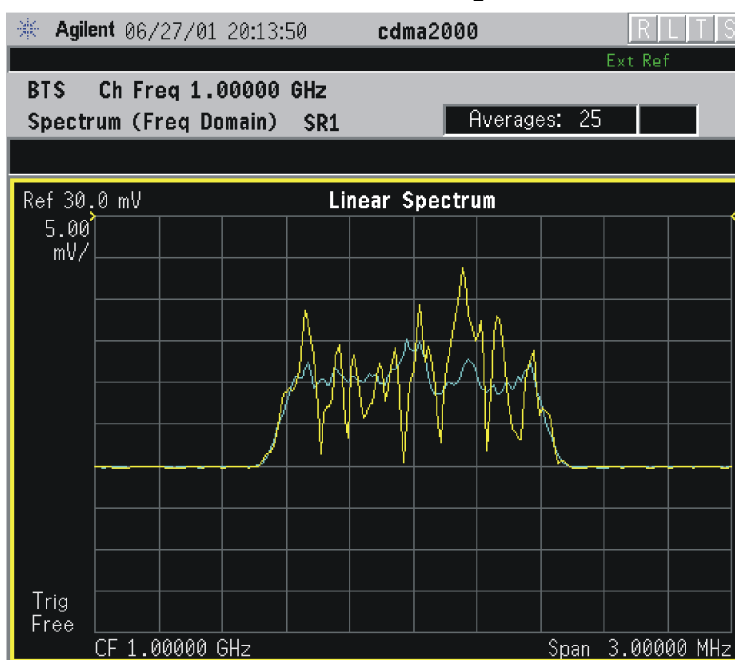
Figure 2-53 Spectrum Measurement - Linear Spectrum View (for E4406A)



*Meas Setup: View/Trace = Spectrum Linear,
Span = 5.000 MHz,
Y Scale/Div = 5.0 mV, Ref Value = 40.0 mV,
Others = Factory default settings

*Input signals: -10.00 dBm, PCCPCH + SCH

Figure 2-54 Spectrum Measurement - Linear Spectrum View (for E4406A)

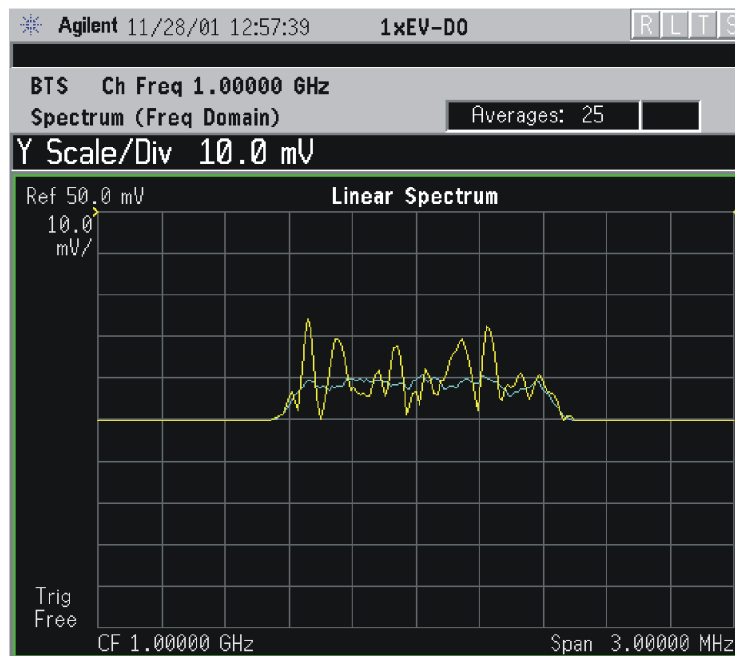


*Meas Setup: View/Trace = Spectrum Linear,

Span = 3.000 MHz,
Y Scale/Div = 5.00 mV, Ref Value = 30.0 mV,
Others = Factory default settings

*Input signals: -10.00 dBm, 9 channels of SR1, cdma2000 Rev 8

Figure 2-55 Spectrum Measurement - Linear Spectrum View (for E4406A)



*Meas Setup: View/Trace = Spectrum Linear,
Span = 3.000 MHz,
Y Scale/Div = 10.00 mV, Ref Value = 50.0 mV,
Others = Factory default settings

*Input signals: -10.00 dBm, Pilot channel, 1xEV-DO

NOTE

(for E4406A) For the widest spans, the I/Q window becomes just “ADC time domain samples”, because the I/Q down-conversion is no longer in effect. This is not the case for E4406A Option B7C if the **Input Port** is set to either **I/Q**, **I only**, or **Q only** and you have connected baseband I/Q signals to the **I/Q INPUT** connectors.

- **I and Q Waveform** - (for E4406A) Provides individual views of the I and Q signal waveform windows in parameters of voltage versus time.

To select the I or Q trace view, press the **Next** key at the bottom of the display. The selected window will have a green outline. To view the window full size press the **Zoom** key.

Figure 2-56 Spectrum Measurement - I and Q Waveform View (for E4406A)

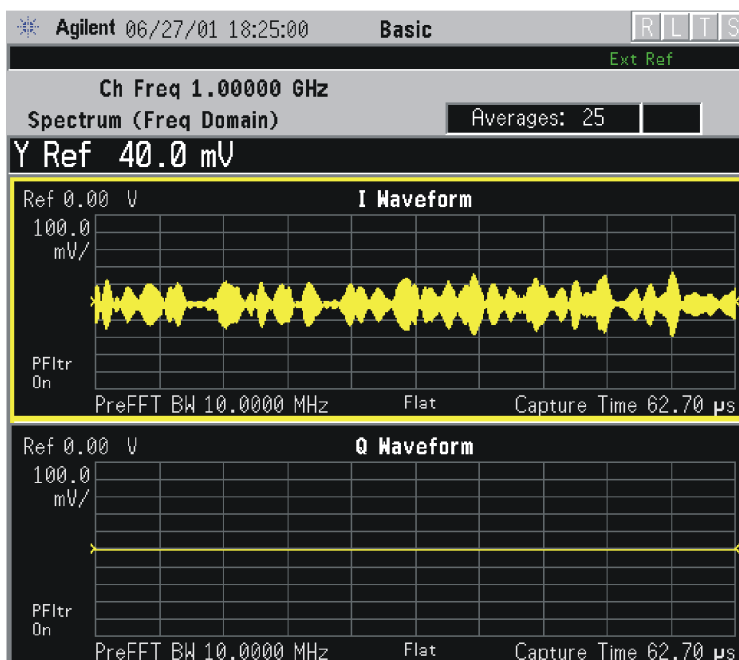
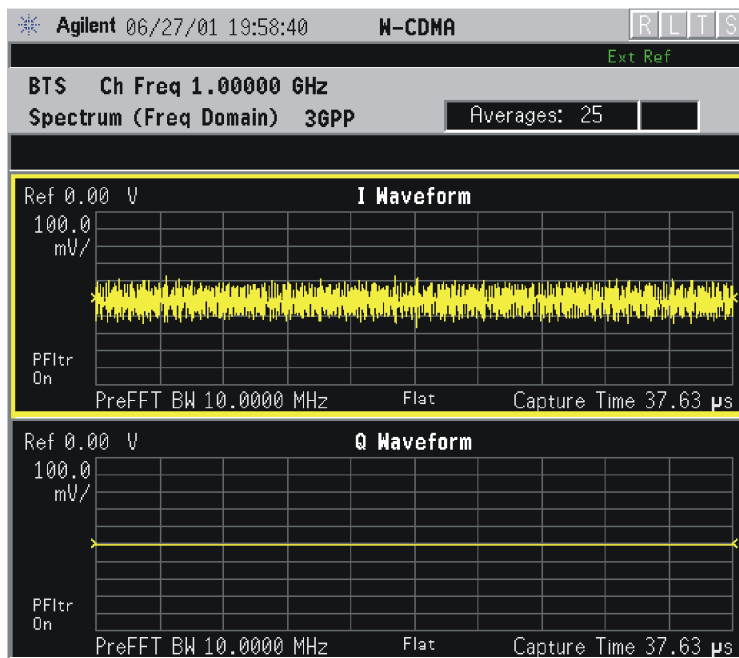


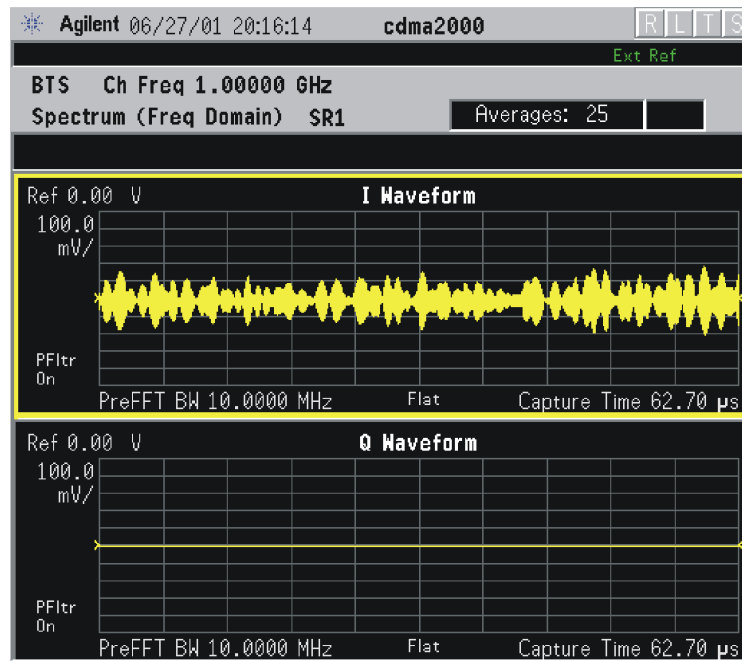
Figure 2-57 Spectrum Measurement - I and Q Waveform View (for E4406A)



*Meas Setup: View/Trace = I and Q Waveform,
 Others = Factory default settings

*Input signals: -10.00 dBm, PCCPCH + SCH

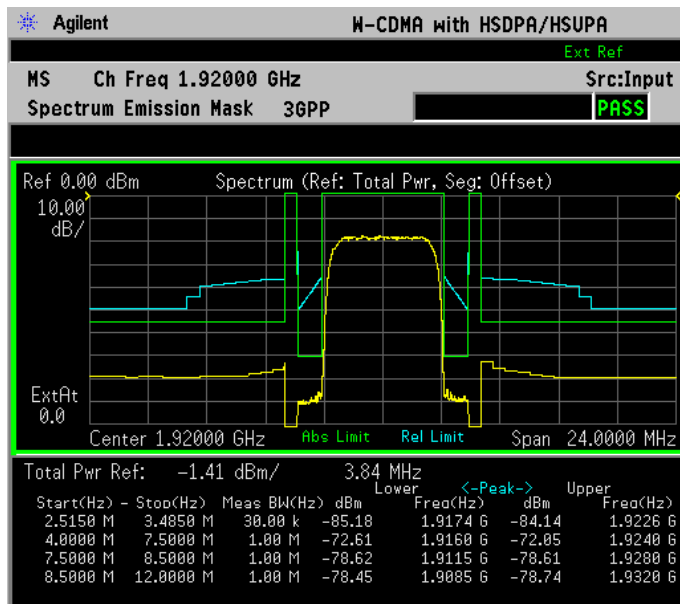
Figure 2-58 Spectrum Measurement - I and Q Waveform View (for E4406A)



*Meas Setup: View/Trace = I and Q Waveform,
AMPLITUDE Y Scale = 5.00 mV,
Others = Factory default settings

*Input signals: -10.00 dBm, 9 channels of SR1, cdma2000 Rev 8

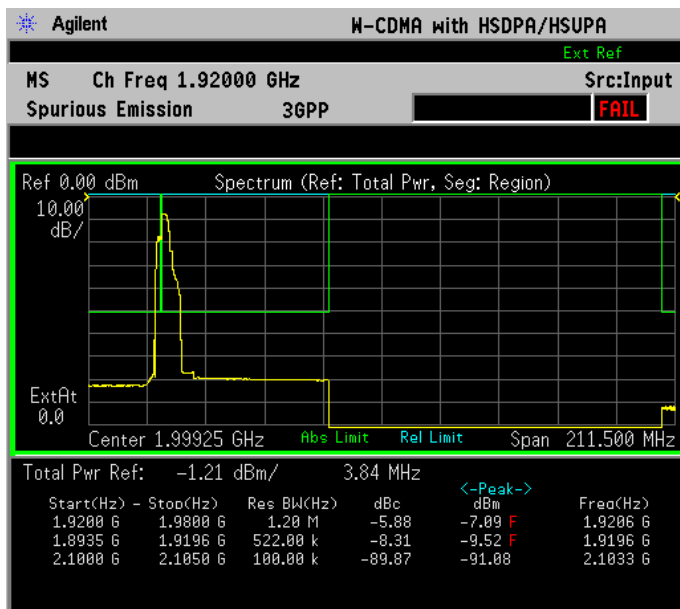
Figure 2-59 Spectrum Measurement - I and Q Waveform View (for E4406A)



*Meas Setup: View/Trace = I and Q Waveform,
Others = Factory default settings

*Input signals: -10.00 dBm, Pilot channel, 1xEV-DO

Figure 2-60 Spectrum Measurement - I and Q Waveform View (for E4406A)



*Meas Setup: View/Trace = I and Q Waveform
Span = 500.000 kHz,
Y Scale/Div = 5.0 mV, Ref Value = 0.0 V,
Others = Factory default settings

*Input signals: -20.00 dBm, EDGE pattern data (PN9)

- **I/Q Polar** - (for E4406A) Provides a view of the I/Q signal displayed in a polar vector graph.

Figure 2-61 Spectrum Measurement - I/Q Polar View (for E4406A)

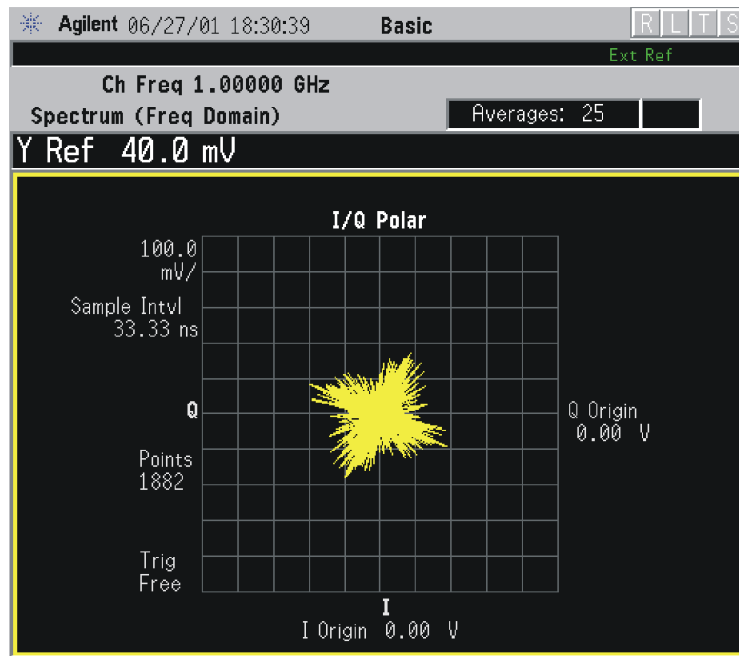
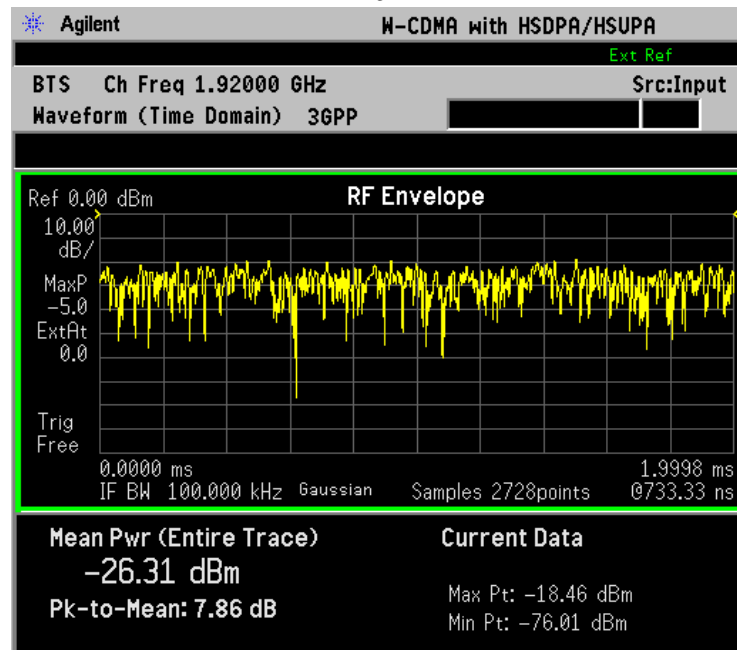


Figure 2-62 Spectrum Measurement - I/Q Polar View (for E4406A)



*Meas Setup: View/Trace = I/Q Polar,
Others = Factory default settings

*Input signals: -10.00 dBm, PCCPCH + SCH

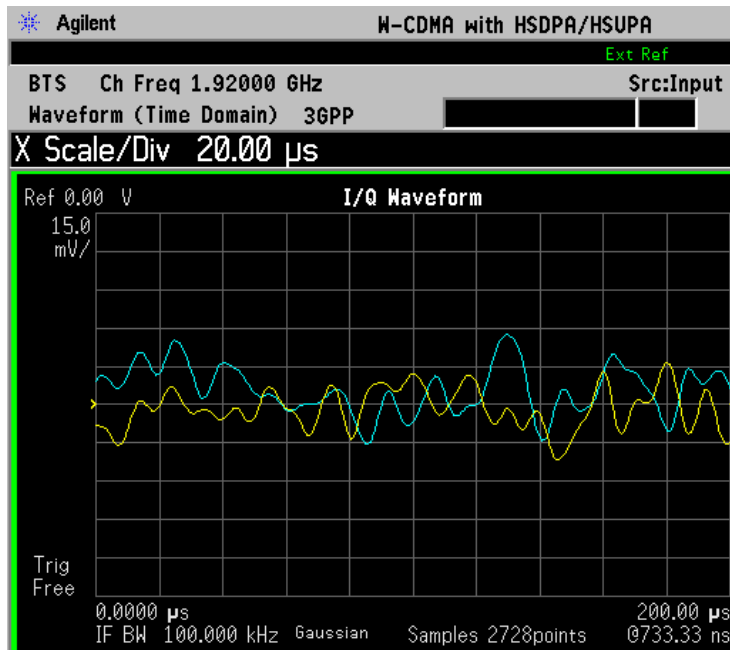
Figure 2-63 Spectrum Measurement - I/Q Polar View (for E4406A)



*Meas Setup: View/Trace = I/Q Polar,
Others = Factory default settings

*Input signals: -10.00 dBm, Pilot channel of SR1, cdma2000 Rev 8

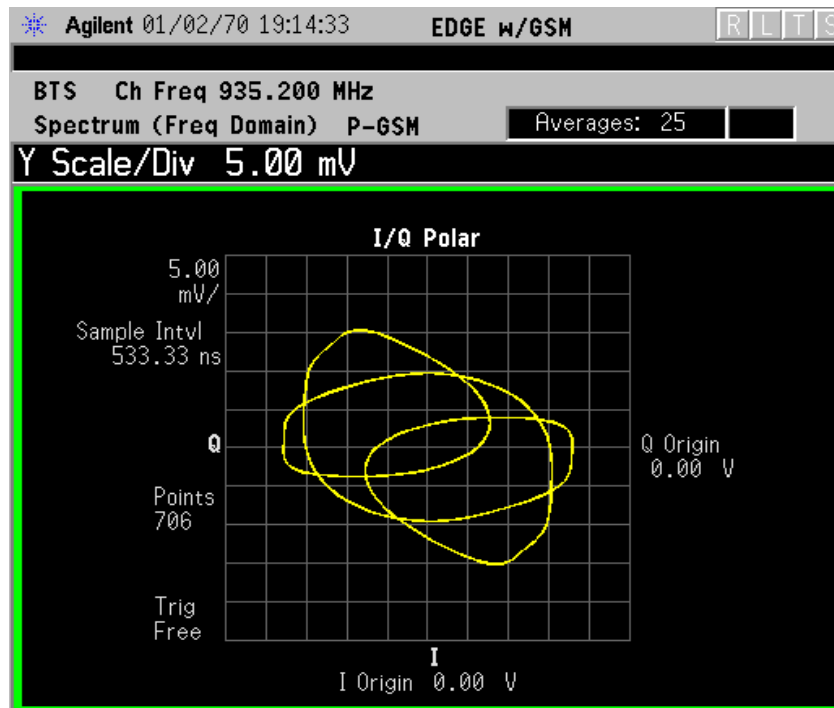
Figure 2-64 Spectrum Measurement - I/Q Polar View (for E4406A)



*Meas Setup: View/Trace = I/Q Polar,
Others = Factory default settings

*Input signals: -10.00 dBm, Pilot channel, 1xEV-DO

Figure 2-65 Spectrum Measurement - I/Q Polar View (for E4406A)



*Meas Setup: View/Trace = I/Q Polar
Span = 500.000 kHz,
Y Scale/Div = 5.0 mV, Ref Value = 0.0 V,
Others = Factory default settings

*Input signals: -20.00 dBm, EDGE pattern data (PN9)

Step 7. To make a measurement repeatedly, press **Meas Control**, **Measure** to toggle the setting from **Single** to **Cont**.

Step 8. For PSA, if Option 122 or 140 is installed, you may use the wideband IF hardware to view a wide bandwidth signal in the Spectrum view. The I/Q Waveform view will be correctly demodulated to the I and Q components over the entire display bandwidth.

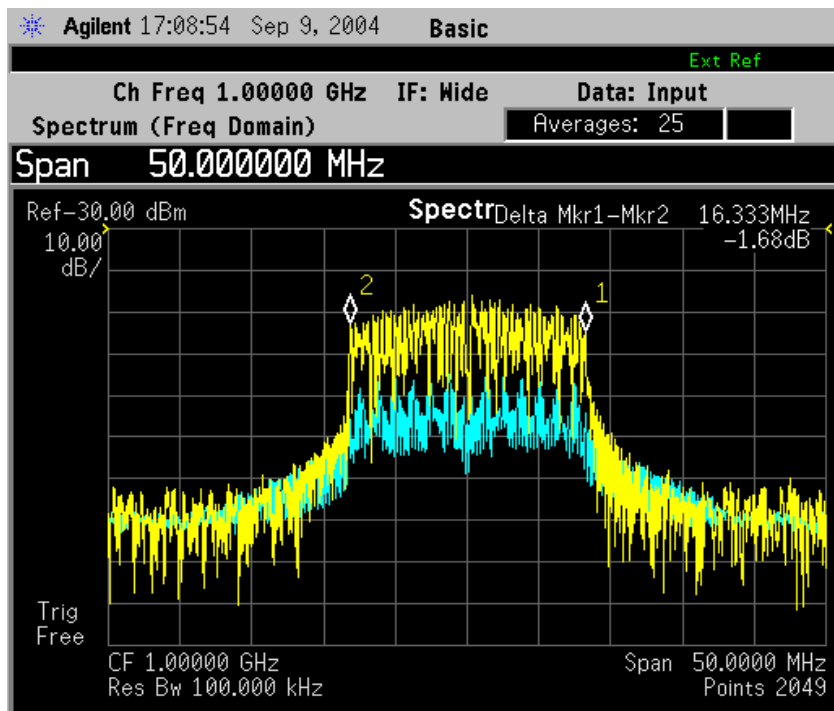
- Press **Mode**, and select **Basic** or **Modulation Analysis** to be able to use the Wideband IF path.
- Press **Measure**, and select the **Spectrum** measurement.
- Press **SPAN** and toggle the **IF Path** key to select **Wide**. Adjust the span to view up to 80 MHz for Option 122, or up to 40 MHz for Option 140 around your selected center frequency. Note the example below has 1 million data points.

The example shown below is a 54 carrier OFDM signal which has a -10 dB bandwidth greater than 16 MHz, with skirts to over twice that

bandwidth. Delta markers are shown measuring the peak bandwidth.

Figure 2-66

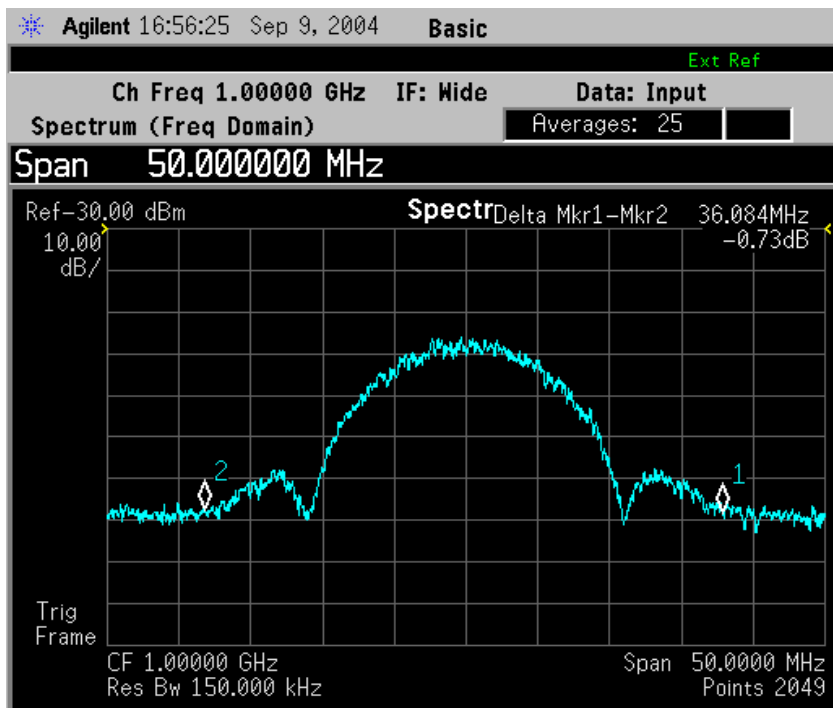
Spectrum Measurement - Spectrum Zoom View with Opt. 122–80 MHz Bandwidth Digitizer Hardware



The example shown below is a 802.11 WLAN signal which has an instantaneous bandwidth of over 36 MHz. Only the Average trace is displayed.

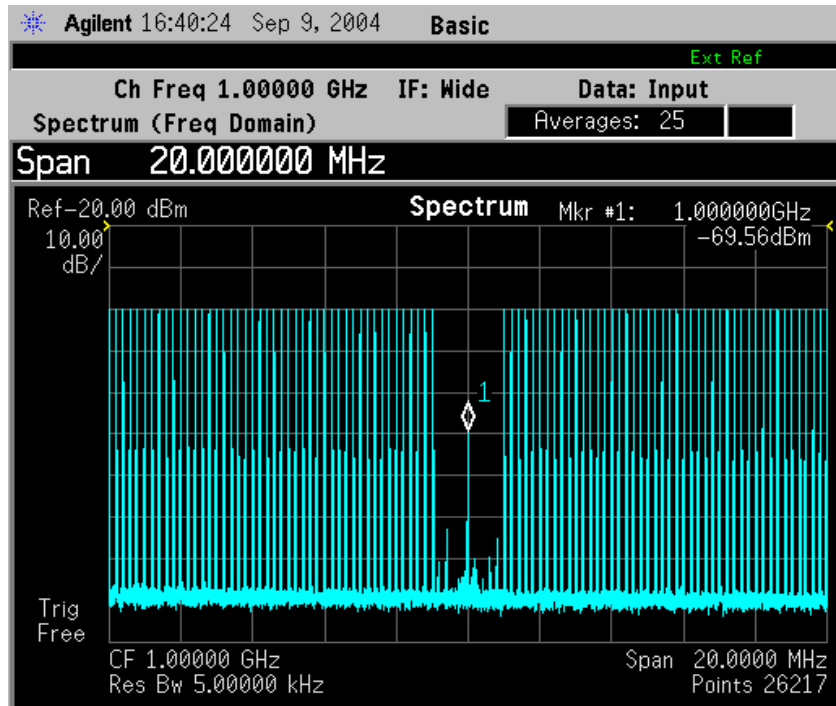
When using the widest spans, the Resolution Bandwidth may be limited by the maximum number of points available for a Spectrum measurement. If your desired setting exceeds the available number of points, the maximum number available will be used, and an error message will be displayed.

Figure 2-67 Spectrum Measurement - Spectrum Zoom View with Opt. 122–80 MHz Bandwidth Digitizer Hardware



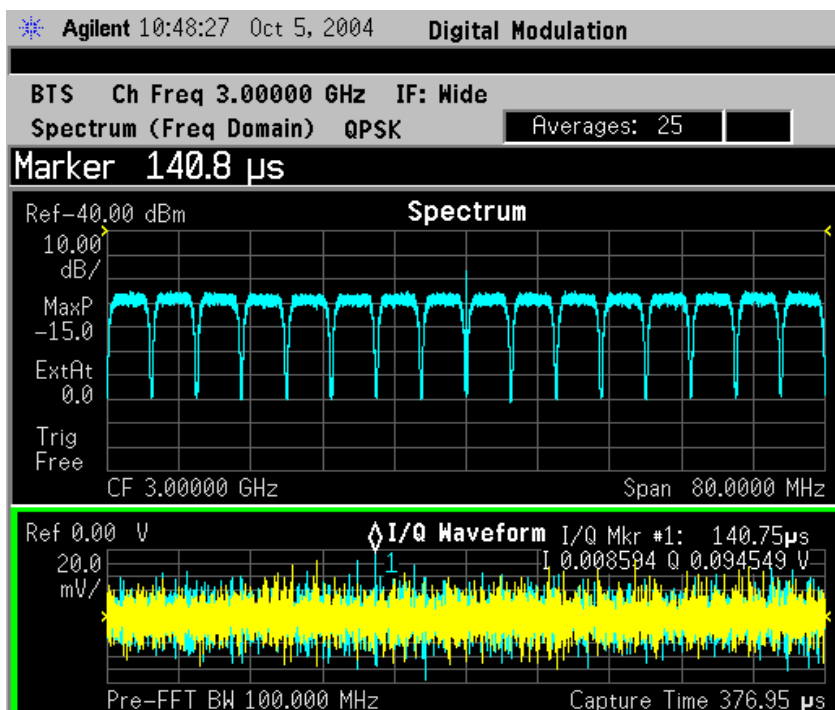
The example shown below is a Spectrum View of the center 20 MHz of a Noise Power Ratio measurement. If you extend the Span to the full 80 MHz bandwidth, individual carriers displayed may merge, as they can be limited by screen resolution and resolution bandwidth. Only the Average data trace is displayed in the example below.

Figure 2-68 Spectrum Measurement - Spectrum View with Opt. 122– 80 MHz Bandwidth Digitizer Hardware



The wideband signal example shown below is 16 W-CDMA carriers, each occupying 5 MHz of bandwidth. The full 80 MHz of available demodulation bandwidth for the Spectrum measurement is used. Only the Average trace is displayed. Note the demodulated composite I/Q waveform for the entire 80 MHz BW signal in the I/Q Waveform window below. A peak search marker has been applied to the composite waveform.

Figure 2-69 Spectrum Measurement - Spectrum Zoom View with Opt. 122–80 MHz Bandwidth Digitizer Hardware



Step 9. Press the **Meas Setup, More (1 of 2)** keys to check the keys available to change the measurement parameters from the default condition

For more details about using PSA Wide Bandwidth BW Digitizing Hardware Options 122 and 140, including detailed functional descriptions and SCPI commands and concepts, see the PSA Basic Mode Guide.

For more details about changing measurement parameters, see [“Spectrum \(Frequency Domain\) Measurement Concepts” on page 632](#)

Spectrum Emission Mask Measurements

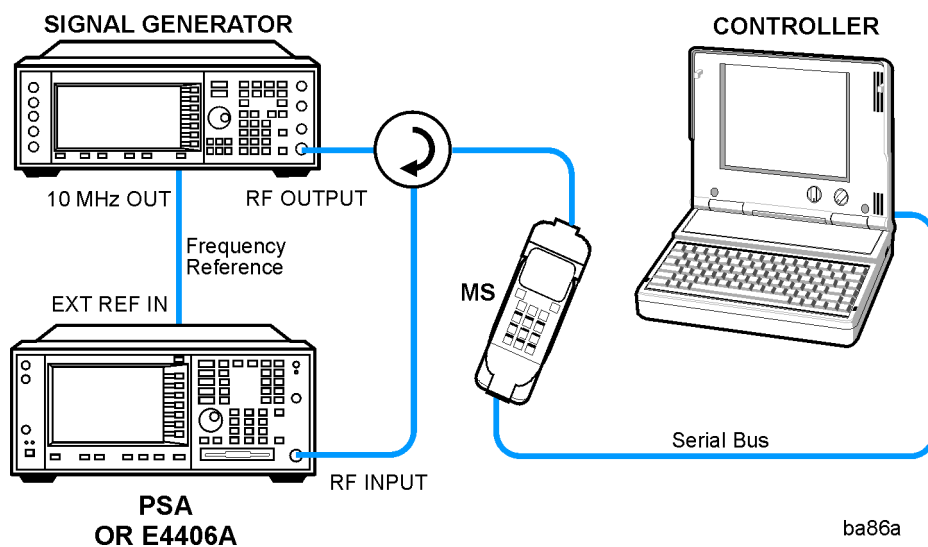
This section explains how to make the spectrum emission mask measurement on a W-CDMA (3GPP) mobile station. SEM compares the total power level within the defined carrier bandwidth and the given offset channels on both sides of the carrier frequency, to levels allowed by the standard. Results of the measurement of each offset segment can be viewed separately.

Configuring the Measurement System

For configuring the measurement system, the mobile station (MS) under test has to be set to transmit the RF power remotely through the system controller. This transmitting signal is connected to the instruments RF input port. Connect the equipment as shown.

Figure 2-70

Spectrum Emission Mask Measurement System



1. Using the appropriate cables, adapters, and circulator, connect the output signal from the MS to the RF input port of the instrument.
2. Connect the base transmission station simulator or signal generator to the MS through the circulator to initiate a link constructed with the sync and pilot channels, if required.
3. Connect a BNC cable between the 10 MHz OUT port of the signal generator and the EXT REF IN port of the instrument.
4. Connect the system controller to the MS through the serial bus cable to control the MS operation.

Setting the MS

From the base transmission station simulator and/or the system controller, perform all of the call acquisition functions required for the MS to transmit the RF power as follows:

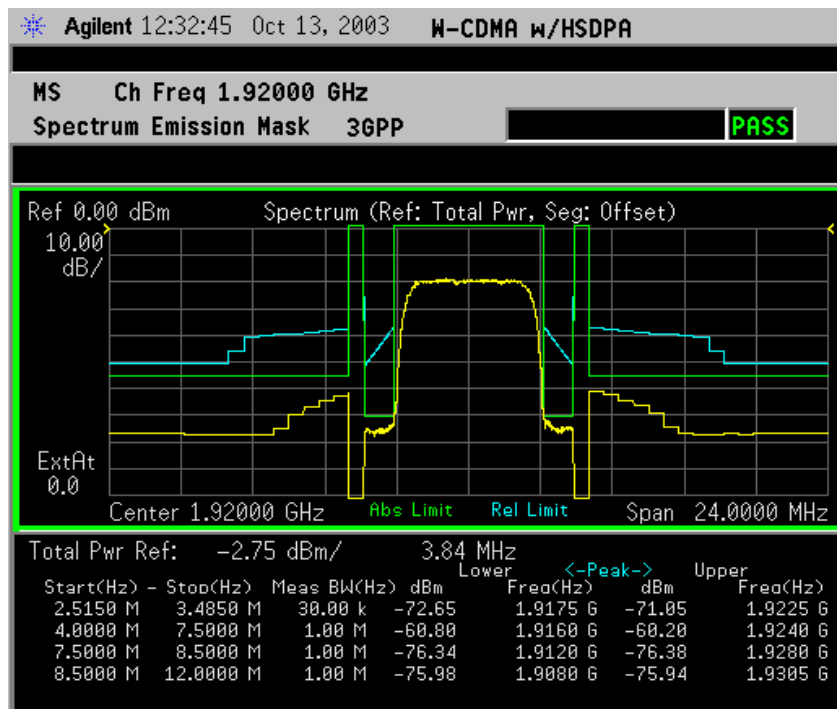
Frequency: 1,920 MHz (Channel Number: $5 \times 1,920 = 9,600$)

Output Power: 0 dBm (at analyzer input)

Measurement Procedure

- Step 1.** Press the **Preset** key to preset the instrument.
- Step 2.** Press the **MODE, More (1 of 2), W-CDMA (3GPP)** keys to enable the W-CDMA (3GPP) measurements.
- Step 3.** Press the **Mode Setup, Radio, Device** to toggle the device to **MS**.
- Step 4.** Press the **FREQUENCY Channel, 1920, MHz** keys to set the center frequency to 1.920 GHz.
- Step 5.** Press the **MEASURE, Spectrum Emission Mask** keys to initiate the spectrum emission mask measurement.

Figure 2-71 Spectrum Emission Mask Measurement Result - Offset Segment (Default) View



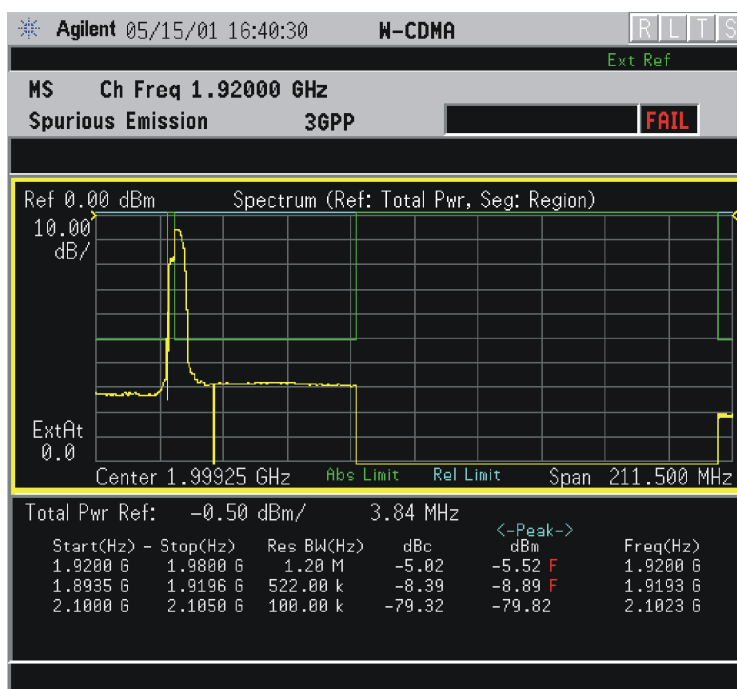
The Spectrum Emission Mask: Spectrum (Ref: Total Pwr, Seg: Offset) measurement result should look like [Figure 2-71 on page 146](#). The text window shows the reference total power and the absolute peak power levels which correspond to the frequency bands on both sides of the reference channel.

Step 6. Press the **Meas Setup, Spectrum Segment** keys to toggle to **Region**.

The Spurious Emission: Spectrum (Ref: Total Pwr, Seg: Region) measurement result should look like the next figure.

Figure 2-72

Spectrum Emission Mask Measurement Result - Region Segment



If you have a problem, and get an error message, see [“Interpreting Common Error Codes” on page 183](#) or the “Instrument Messages and Functional Tests” manual.

Troubleshooting Hints

This spectrum emission mask measurement can reveal degraded or defective parts in the transmitter section of the UUT. The following examples are those areas to be checked further.

- Faulty DC power supply control of the transmitter power amplifier.
- RF power controller of the pre-power amplifier stage.
- I/Q control of the baseband stage.
- Some degradation in the gain and output power level of the amplifier due to the degraded gain control and/or increased distortion.
- Some degradation of the amplifier linearity or other performance characteristics.

Power amplifiers are one of the final stage elements of a base or mobile transmitter and are a critical part of meeting the important power and spectral efficiency specifications. Since spectrum emission mask measures the spectral response of the amplifier to a complex wideband signal, it is a key measurement linking amplifier linearity and other performance characteristics to the stringent system specifications.

Waveform (Time Domain) Measurements

This section explains how to make waveform (time domain) measurement on a W-CDMAcdma2000GSM with EDGE1xEV-DOcellular base station. Measurement of I and Q modulated waveforms in the time domain disclose the voltages which comprise the complex modulated waveform of a digital signal.

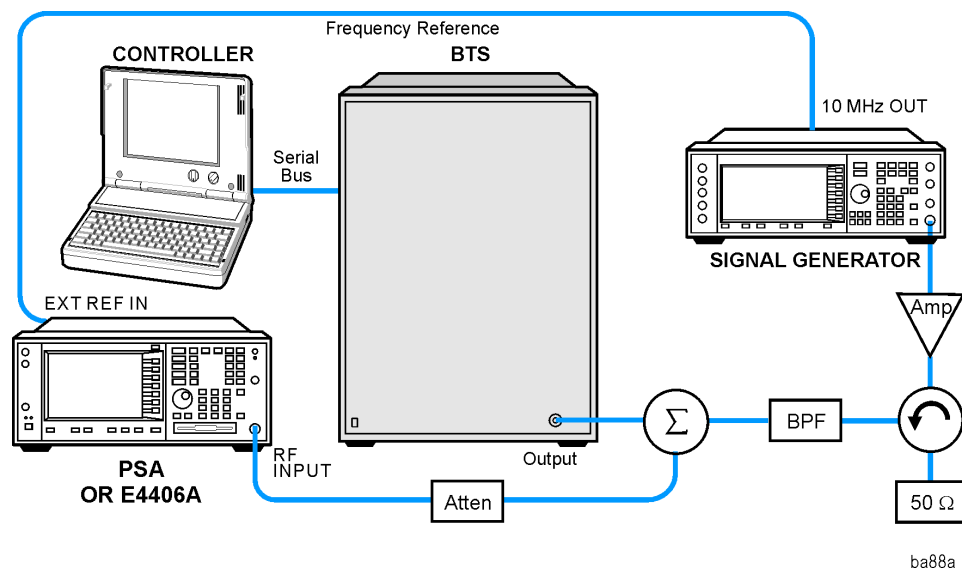
If installed, you may use PSA Option 122, the 80 MHz Bandwidth Digitizer hardware, or PSA Option 140, the 40 MHz Bandwidth Digitizer hardware to perform Waveform measurements of wideband signals using Basic Mode.

Configuring the Measurement System

The base station (BTS) under test has to be set to transmit the RF power remotely through the system controller. This transmitting signal is connected to the instruments RF input port. Connect the equipment as shown. An interfering or adjacent signal may supplied as shown.

Figure 2-73

Waveform Measurement System



1. Using the appropriate cables, adapters, and circulator, connect the output signal of the BTS to the RF input of the instrument.
2. Connect the base transmission station simulator or signal generator to the BTS through a circulator to initiate a link constructed with sync and pilot channels, if required.
3. Connect a BNC cable between the 10 MHz OUT port of the signal generator and the EXT REF IN port of the instrument.

4. Connect the system controller to the BTS through the serial bus cable to control the BTS operation.
5. Connect an external trigger, if needed. Press **Mode Setup, Trigger** to access a menu to set up inputs and levels for all triggers. You must then select the appropriate trigger under the **Meas Setup, Trigger** menu to direct the measurement to use your trigger settings.

Setting the BTS

From the base transmission station simulator and the system controller, set up a call using loopback mode for the BTS to transmit the RF signal.

Measurement Procedure

- Step 1.** Press the **Preset** key to preset the instrument.
- Step 2.** Press the **MODE**, GSM with EDGEBasic1xEV-DO keys to enable the GSM with EDGEBasic1xEV-DO Mode measurements.
- Step 3.** To set the measurement center frequency press the **FREQUENCY Channel** key, enter a numerical frequency using the front-panel keypad, and complete the entry by selecting a units key, like **MHz**.
- Step 4.** Press the **SPAN** key, enter a numerical span using the front-panel keypad, and press the **MHz** key to set the measurement span in MHz.
- Step 5.** Press the **MEASURE** to initiate the Waveform measurement.

The default display shows both **Current** (yellow trace) and **Average** (blue trace) data. To make viewing the display easier, you can view either the **Current** trace or **Average** separately.

- Press **Trace/View, Trace Display**, and select the trace(s) desired for display.

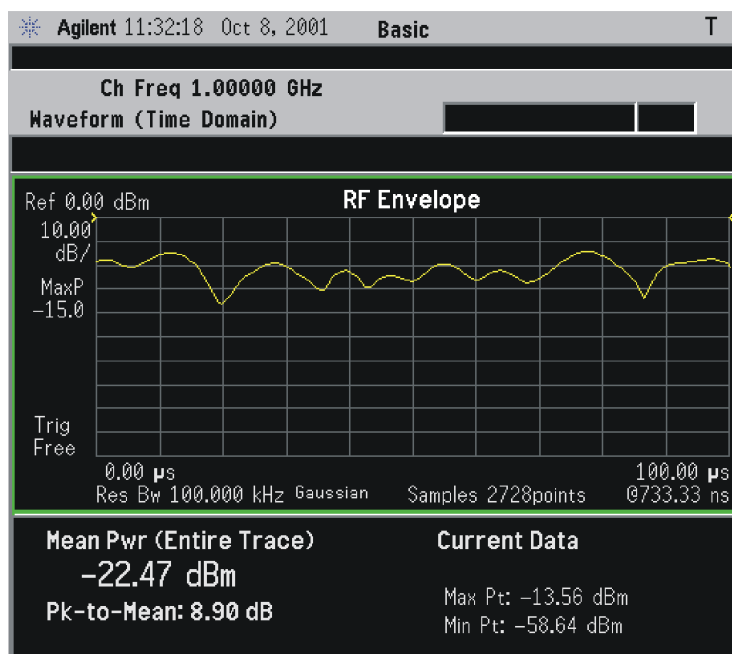
- Step 6.** Press **SPAN X Scale**, and the up or down arrow keys until the waveform is shown at a convenient time scale for viewing.

If installed, you may use the 80 MHz Bandwidth hardware to view a wideband signal in the RF Envelope view.

Press **SPAN** and select the **Wideband** RF Path. Adjust the span to view up to 80 MHz around your selected center frequency.

The next figure shows an example of an **RF Envelope** (key is called **Signal Envelope** on VSA) result for a waveform (time domain) measurement. The measured values for the mean power and peak-to-mean power are shown in the text window.

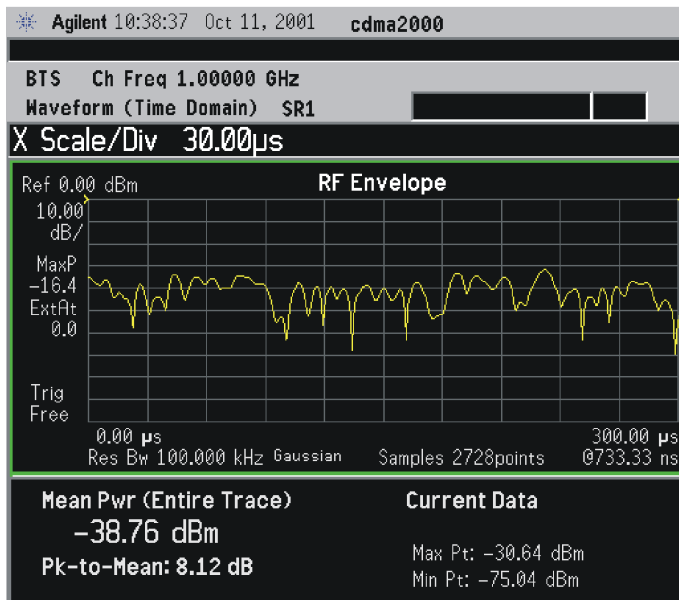
Figure 2-74 Waveform Measurement - RF Envelope (Default View)



*Meas Setup: Trace/View = RF Envelope,
Others = Factory default settings

*Input signal: cdma2000 Rev 8, SR1, 9 Channel

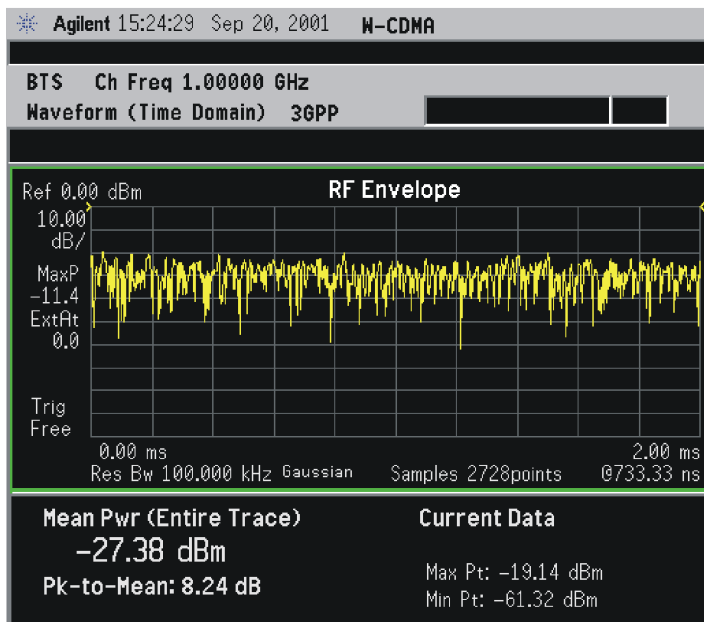
Figure 2-75 Waveform Measurement - RF Envelope (Default View)



*Meas Setup: Trace/View = RF Envelope,
Others = Factory default settings

*Input signal: cdma2000 Rev 8, SR1, 9 Channel

Figure 2-76 Waveform Measurement - RF Envelope (Default View)

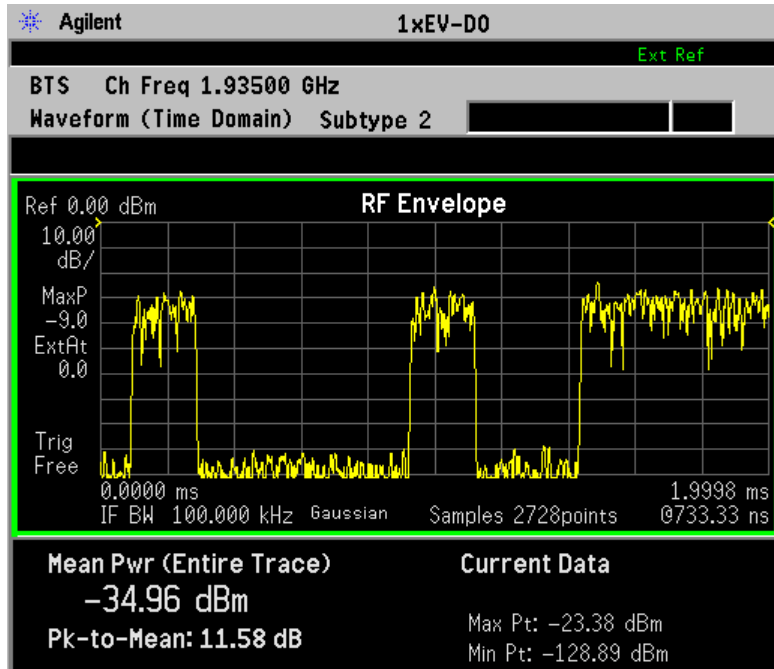


*Meas Setup: Trace/View = RF Envelope View,
Others = Factory default settings

*Input signal: W-CDMA (3GPP 3.4 12-00), 1 DPCH,

Figure 2-77

Waveform Measurement - RF Envelope (Default View)

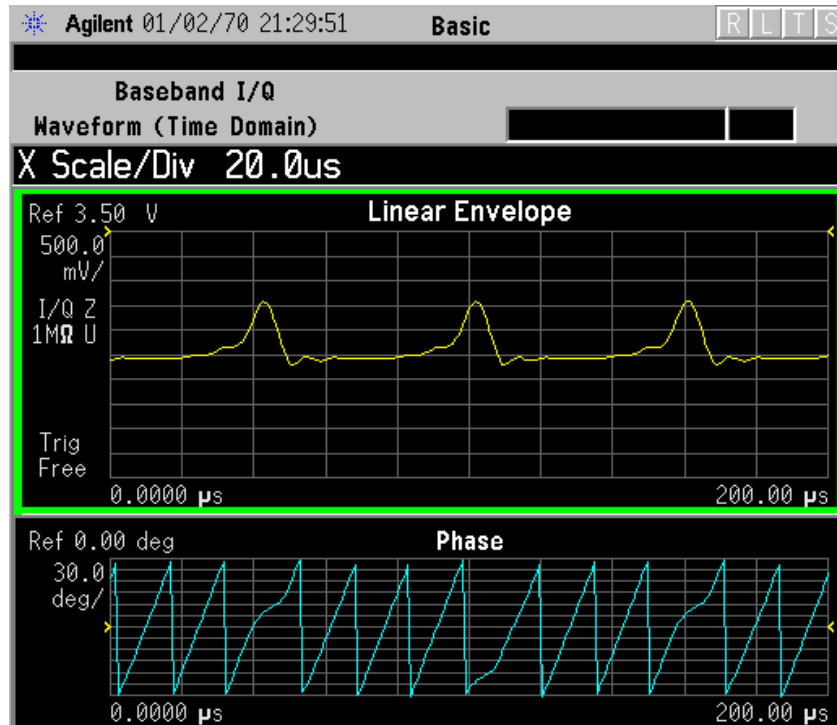


*Meas Setup: View/Trace = RF Envelope,
Trigger Source = Ext Rear,
Others = Factory default settings

*Input signal: -10 dBm, Idle slot, 1xEV-DO

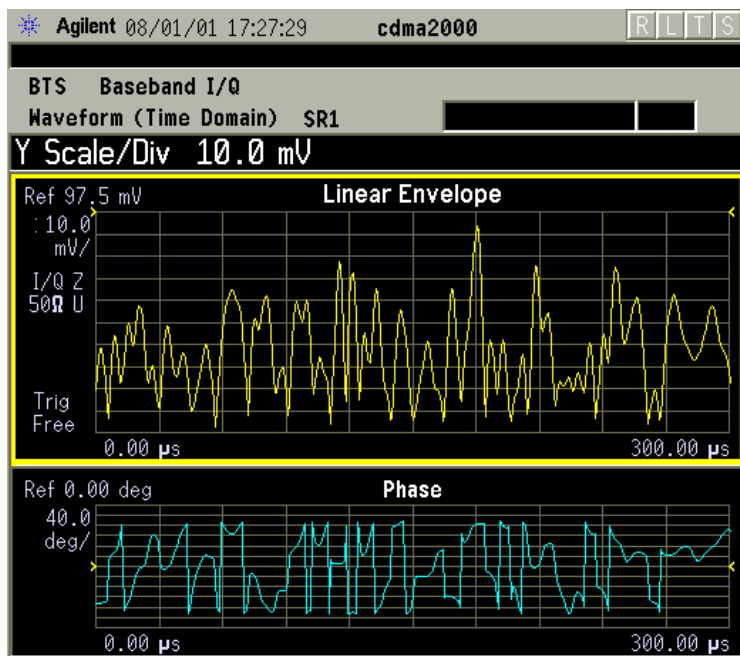
- Step 7.** Press the **Trace/View** (for PSA) or **View/Trace** (for E4406A) key to display the menu allowing selection of the other Waveform views, including the following:
- **Linear Envelope** - (for E4406A Option B7C) Provides a combination view of a linear signal envelope graph and a phase graph with linear graticules. Use the **Next Window** and **Zoom** keys to select and enlarge either graph.

Figure 2-78 Waveform Measurement - Linear Envelope View



*Meas Setup: View/Trace = Linear Envelope View, GSM signal
Others = Factory defaults, except X and Y scales

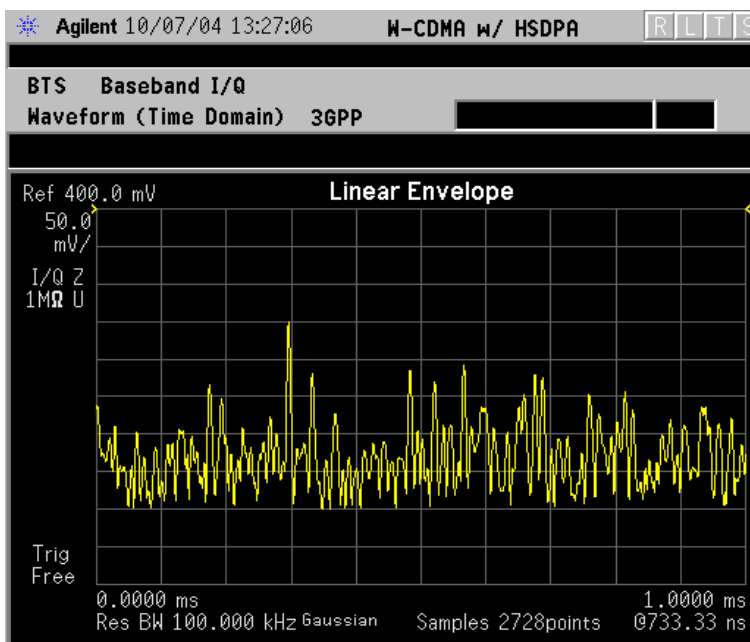
Figure 2-79 Waveform Measurement - Linear Envelope View



*Meas Setup: View/Trace = Linear Envelope View,
 Others = Factory defaults, except X and Y scales

*Input signal: cdma2000 Rev 8, SR1, 9 Channel

Figure 2-80 Waveform Measurement - Linear Envelope View

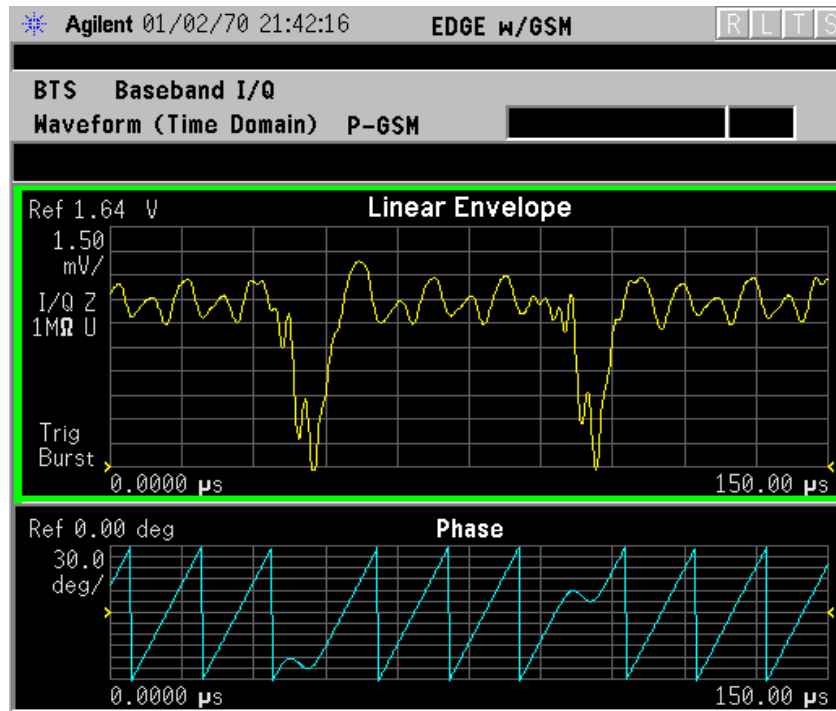


*Meas Setup: View/Trace = Linear Envelope View,
 Others = Factory defaults, except X and Y scales

*Input signal: W-CDMA (3GPP 3.4 12-00), 1 DPCH,

Figure 2-81

Waveform Measurement - Linear Envelope View



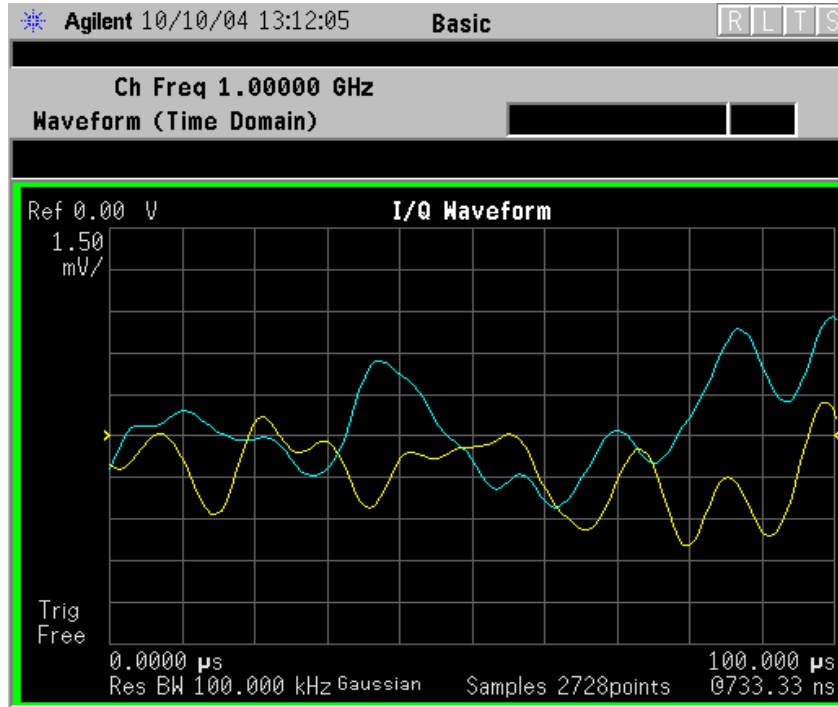
*Meas Setup: View/Trace = Linear Envelope View,
Others = Factory defaults, except X and Y scales

*Input signal: EDGE Standard pattern (4-1's and 4-0's)

- **I/Q Waveform** - Provides a view of the I and Q waveforms together on the same graph in parameters of voltage versus time in linear scale. Changes to sweep time or resolution bandwidth can affect data acquisition.

Figure 2-82

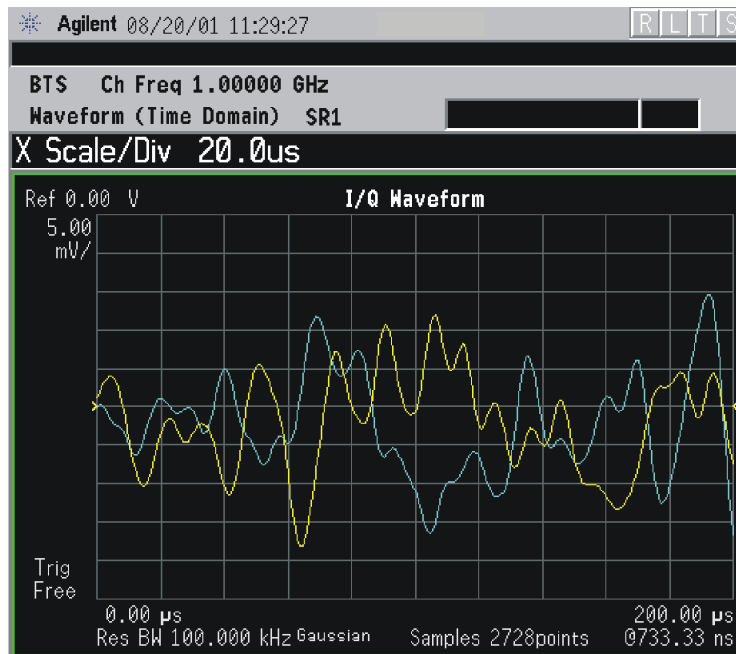
Waveform Measurement - I/Q Waveform View



NOTE

For the widest spans, the I/Q Waveform window becomes just “ADC time domain samples”, because the I/Q down-conversion is no longer in effect.

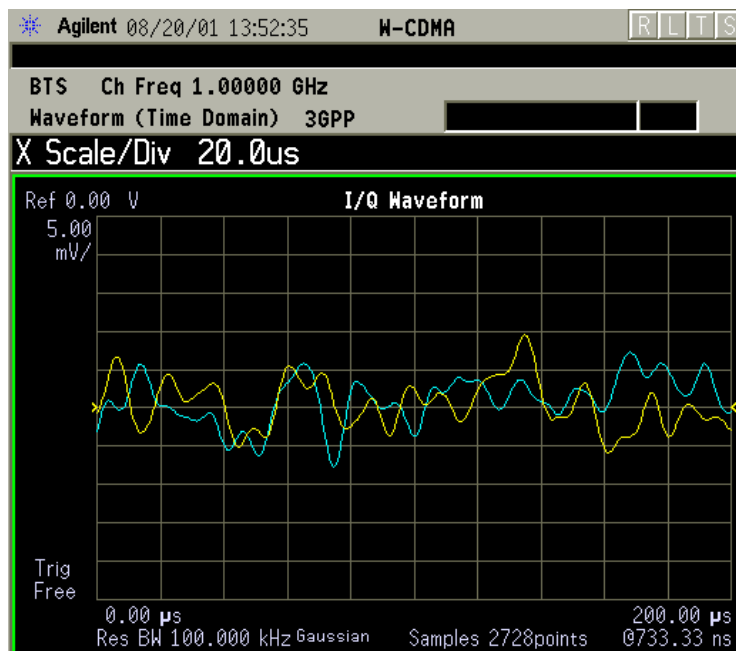
Figure 2-83 Waveform Measurement - I/Q Waveform View



*Meas Setup: View/Trace = I/Q Waveform,
Others = Factory defaults, except X and Y scales

*Input signal: cdma2000 Rev 8, SR1, 9 Channel

Figure 2-84 Waveform Measurement - I/Q Waveform View

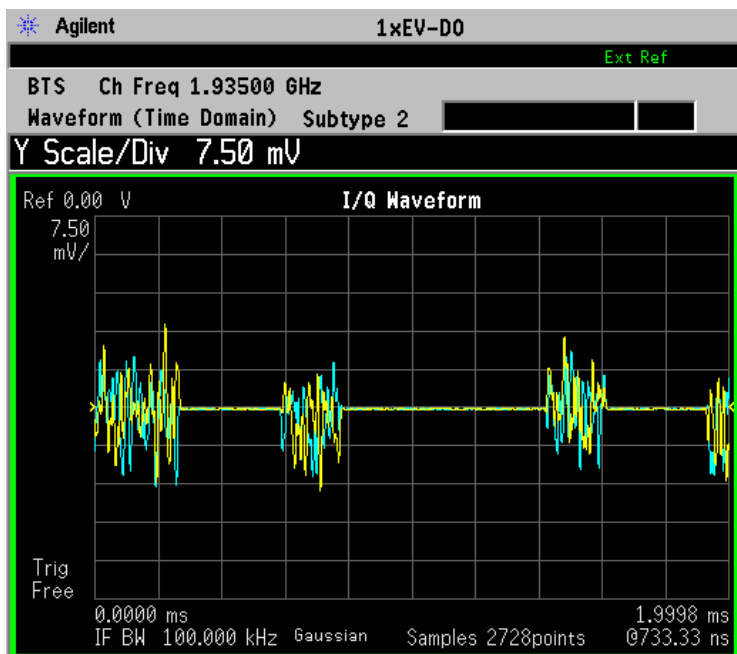


*Meas Setup: View/Trace = Linear Envelope View,
Others = Factory defaults, except X and Y scales

*Input signal: W-CDMA (3GPP 3.4 12-00), 1 DPCH,

NOTE For the widest spans the I/Q Waveform window becomes just “ADC time domain samples”, because the I/Q down-conversion is no longer in effect.

Figure 2-85 Waveform Measurement - I/Q Waveform View



*Meas Setup: View/Trace = I/Q Waveform,
Trigger Source = Ext Rear,
Others = Factory default settings

*Input signal: -10 dBm, Idle slot, 1xEV-DO

- **I and Q Waveform** - (for E4406A Option B7C) Provides a combination view of the I and Q signal waveform graphs in the linear scales.

Figure 2-86

Waveform Measurement - I and Q Waveform View

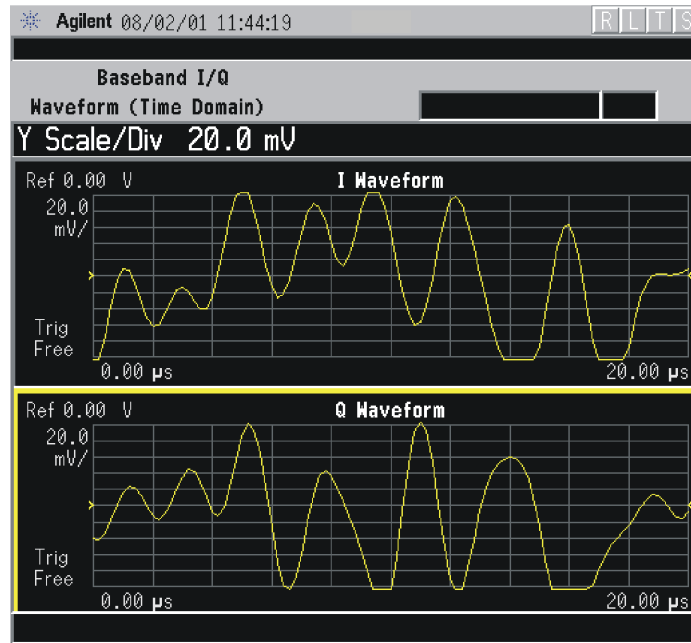


Figure 2-87

Waveform Measurement - I and Q Waveform View

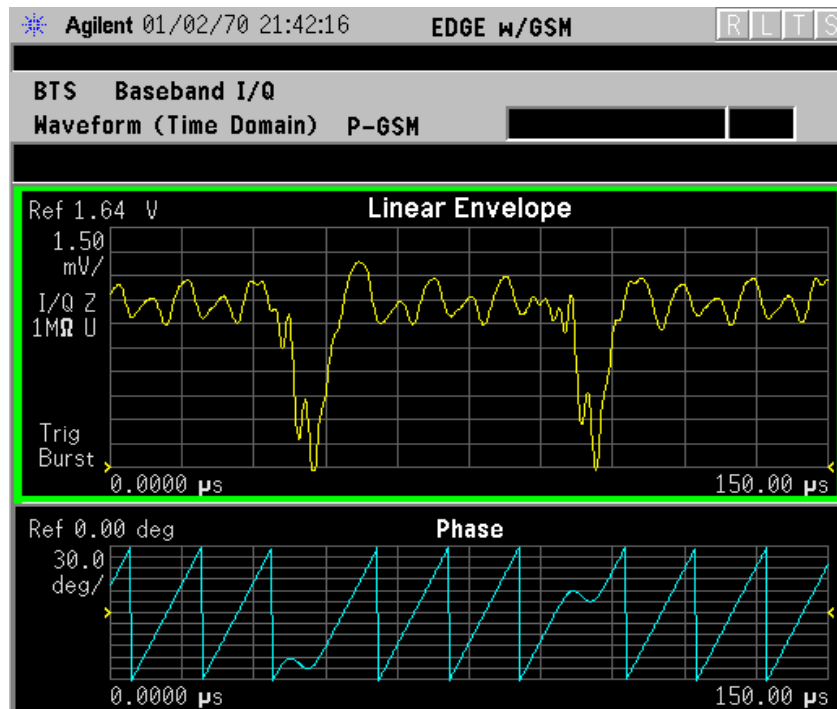
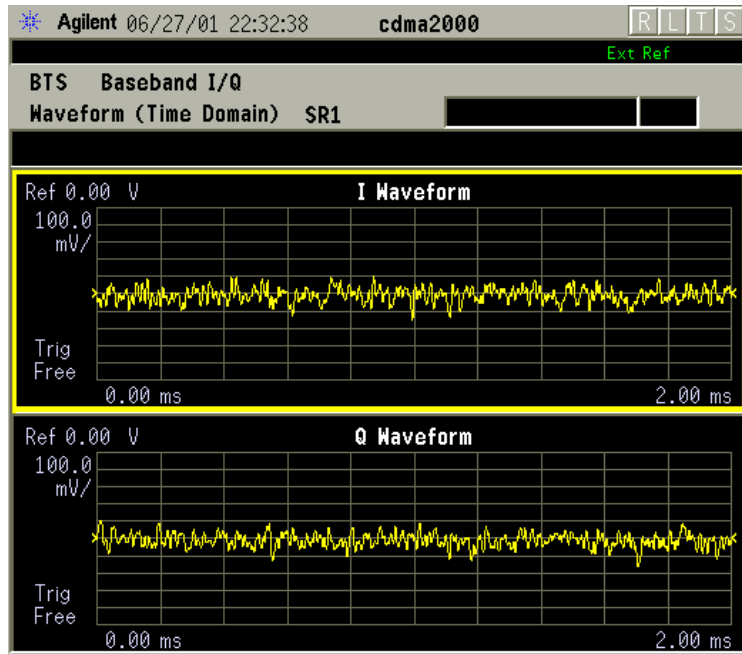


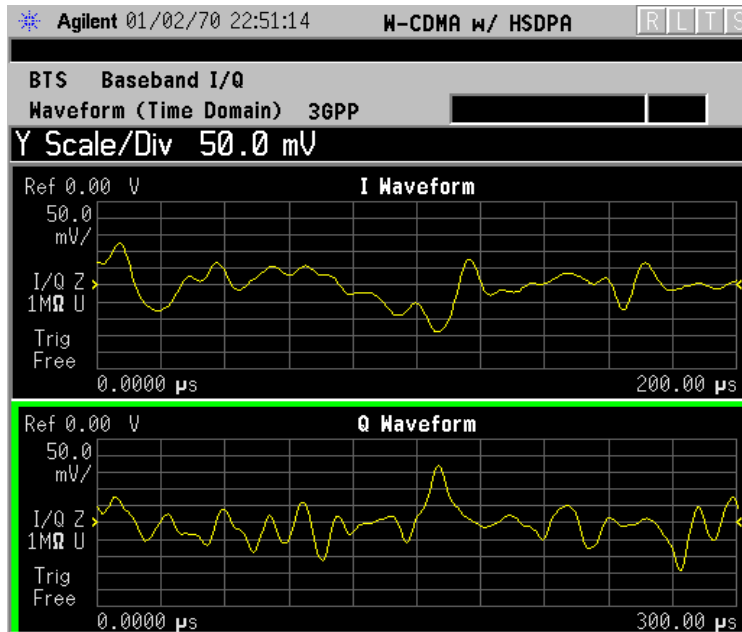
Figure 2-88 Waveform Measurement - I and Q Waveform View



*Meas Setup: View/Trace = I and Q Waveform View,
Others = Factory defaults, except X and Y scales

*Input signal: cdma2000 Rev 8, SR1, 9 Channel

Figure 2-89 Waveform Measurement - I and Q Waveform View



*Meas Setup: View/Trace = I and Q Waveform View,
Others = Factory defaults, except X and Y scales

*Input signal: W-CDMA (3GPP 3.4 12-00), 1 DPCH,

- **I/Q Polar** - (for E4406A) Provides a view of the I/Q signal in a polar vector graph.

Figure 2-90 Waveform Measurement - I/Q Polar View

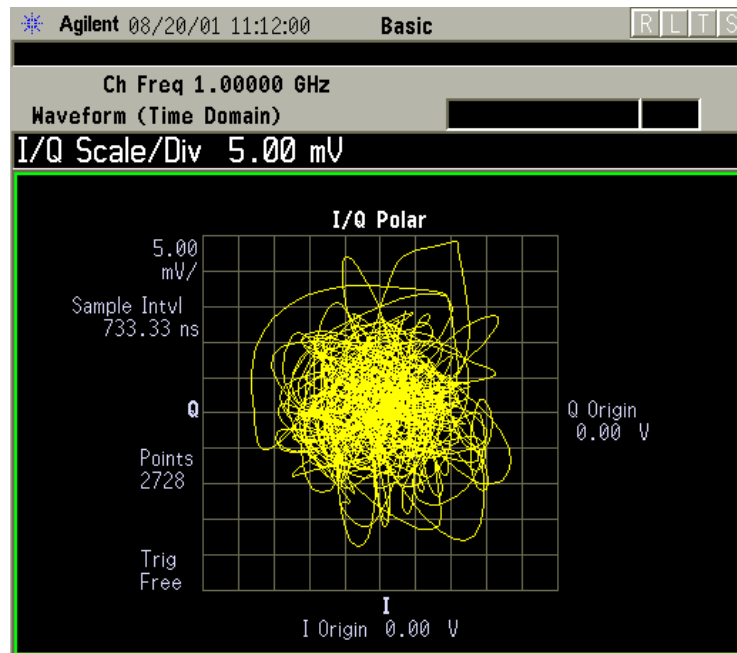


Figure 2-91 Waveform Measurement - I/Q Polar View

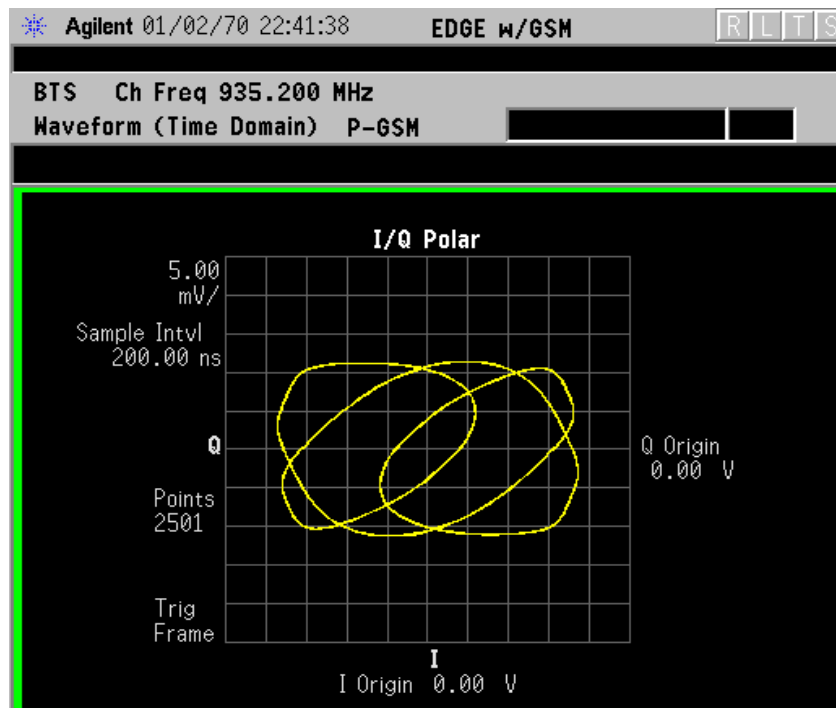
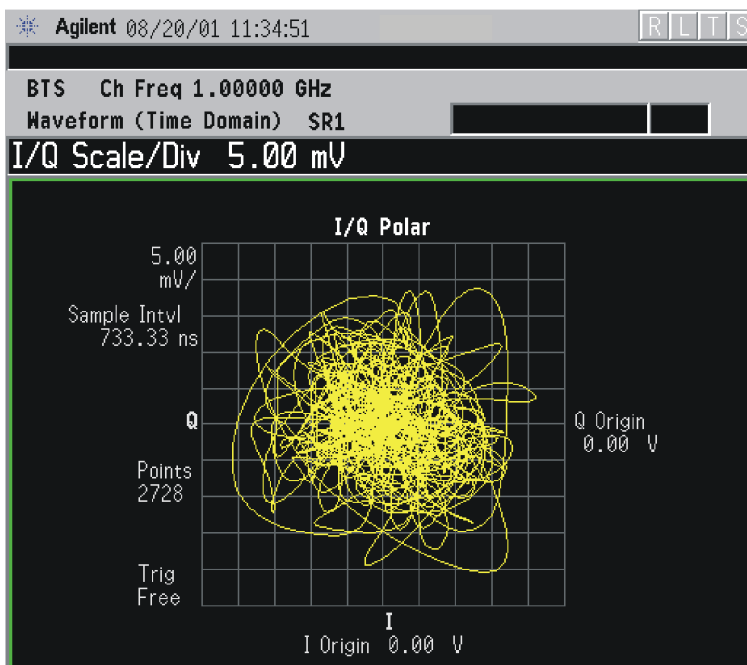


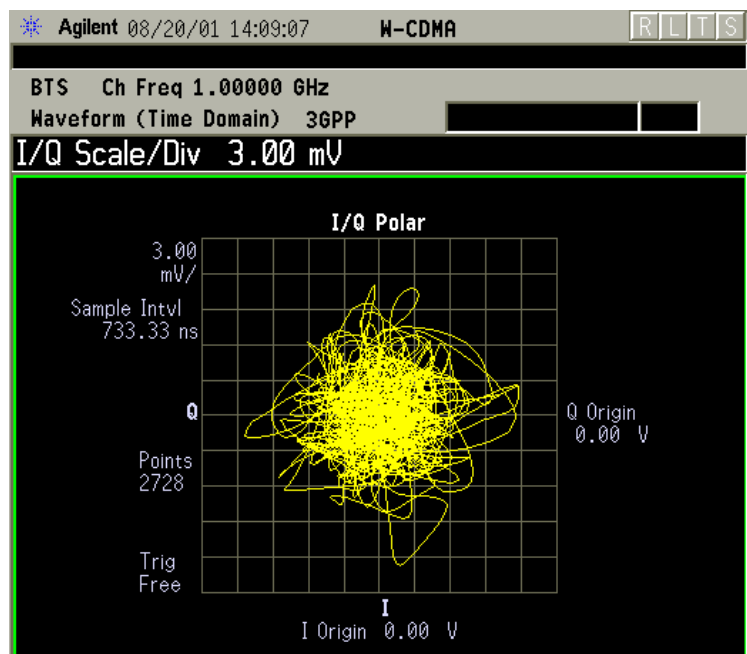
Figure 2-92 Waveform Measurement - I/Q Polar View



*Meas Setup: View/Trace = I/Q Polar View,
Others = Factory defaults, except X and Y scales

*Input signal: cdma2000 Rev 8, SR1, 9 Channel

Figure 2-93 Waveform Measurement - I/Q Polar View



*Meas Setup: View/Trace = I/Q Polar View,
Others = Factory defaults, except X and Y scales

*Input signal: W-CDMA (3GPP 3.4 12-00), 1 DPCH,

Figure 2-94 Waveform Measurement - I/Q Polar View



*Meas Setup: View/Trace = I/Q Polar,
Trigger Source = Ext Rear,
Others = Factory default settings

*Input signal: -10 dBm, Idle slot, 1xEV-DO

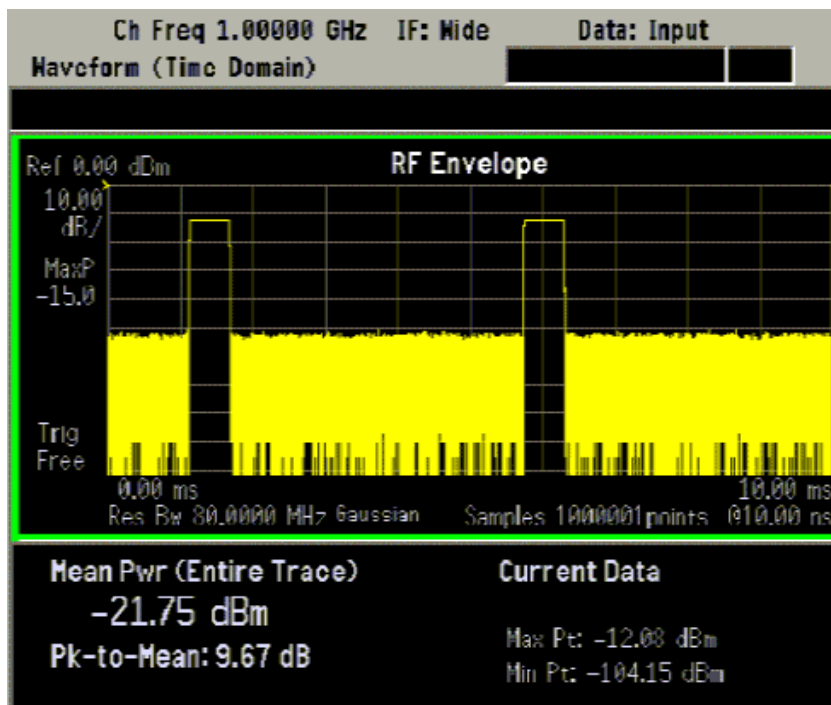
Step 8. If PSA Option 140 or 122 is installed, you may use the 40 or 80 MHz Bandwidth hardware to view a wideband signal in the Waveform view. Even if you are not interested in a wideband signal, using the Wideband IF path provides powerful measurement flexibility, including to the ability to accurately set practically any sample rate and thereby resample waveforms. Resampling, or oversampling, at the correct rate allows you to effectively obtain an integer number of samples per symbol. Make sure that the sample time is aligned with the decision points of the symbols to make analysis of measurement data much easier.

The following example of performing a Wideband IF Waveform measurement of a GSM burst will show the technique to accurately align and resample a signal:

- Press **Mode**, and select **Basic** or **Modulation Analysis** to be able to use the 80 MHz IF path.
- Press **Measure**, and select the **Waveform** measurement.
- Press **Trace/View** and select the **RF Envelope** view.

- Press **SPAN** and toggle the **IF Path** key to select **Wide**. Adjust the span to view up to 80 MHz around your selected center frequency. Note the example below has 1 million data points.

Figure 2-95 Waveform Measurement - RF Envelope View with Opt. 122– 80 MHz Bandwidth Digitizer Hardware



- Make sure that your samples are synchronized to the decision points of the signal of interest. In this case we will use the internal Frame Timer to trigger our measurement. A GSM frame is 4.615383 ms long.

Press **Mode Setup**, **Trigger**, select **Frame Timer**, then select **Period**. Enter 4.615383 ms. This only sets the frame timer period. You must direct the measurement to use the Frame Timer in the next step:

Press **Meas Setup**, **Trigger Source** and select **Frame**.

For other measurements, an external trigger may be applied to an External Trigger Input, on either the front or the rear panels. You must specify that trigger selection in this menu.

- In this example, we want to capture an entire GSM burst of 144 symbols (plus guard). A GSM burst is approximately 4.6 ms, so we will set our **Meas Time** to 5 ms:

Press **Meas Setup**, **Meas Time** and enter 5 ms.

- In this resampling example, we want to take exactly 10 samples per GSM symbol. The GSM symbol rate is 270.833 kHz, so we want a sample rate of 2.70833 MHz. Option 122 Wideband IF hardware lets us set the desired sample rate, as follows: sample rate = 5/4 IF Bandwidth. That means we need set an IF BW of 2.16667 MHz.

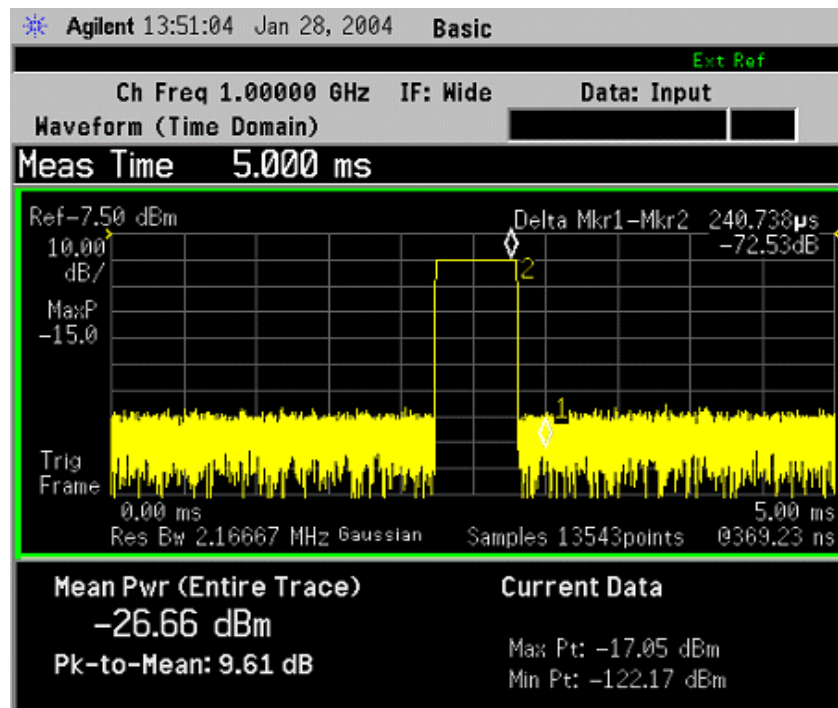
Press **Meas Setup**, **IF BW** and enter 2.16667 MHz.

You can also access the sample rate key directly:

Press **Meas Setup**, **Wideband Setup**, and **Sample Rate** keys. Enter the **Sample Rate** frequency. The **Sample Rate** and **IF BW** settings are coupled. The 5/4 ratio will be preserved regardless of which setting is used.

- Your measurement result should look like [Figure 2-75](#)

Figure 2-96 Waveform Measurement - RF Envelope View with Opt. 122–80 MHz Bandwidth Digitizer Hardware



For more details about making wideband measurements, see the Option 122 section in the Basic Mode Guide.

- Step 9.** Press the **AMPLITUDE Y Scale**, and down arrow keys until the waveforms are shown at a convenient voltage scale for viewing.
- Step 10.** Press the **SPAN X Scale**, and down arrow keys until the waveforms are shown at a convenient time scale for viewing.
- Step 11.** Press the **Marker, Trace**, and **I/Q Waveform** keys to activate a marker. Rotate the RPG knob until the marker is shown at a desired time in the waveform for viewing the trace values at the time position of the marker.
- Step 12.** To make a measurement repeatedly, press **Meas Control, Measure** to toggle the setting from **Single** to **Cont**.
- Step 13.** Press the **Meas Setup, More (1 of 2)** keys to check the keys available to change the measurement parameters from the default condition.

Using the Waveform Measurement to Set Up Triggering (for burst signals)

You can use the waveform measurement to view your signal in the time domain and to help select the appropriate trigger to acquire your signal.

- Step 1.** Activate the waveform measurement view:
Press **MEASURE, Waveform (Time Domain)**.
- Step 2.** Adjust the scale of the x-axis to view the complete signal waveform:
Press **SPAN X Scale, Scale/Div**, then use the front-panel keypad to input the scale/div, then press a units key, like μs , to complete the entry.
- Step 3.** Select a trigger source (free run is the default setting):
Press **Meas Setup, Trig Source**, then select one of the available trigger sources.

NOTE

In the waveform measurement the **Burst/Sync Search** menu is not available. **Burst/Sync Search** is available in the **Modulation Analysis** measure mode. **Frame Timer** (located under the **Trig Setup** menu) must be used to trigger on framed signals in the **Waveform** measurement.

Step 4. Setup the trigger conditions:

Press **Trig** or for E4406A press **Mode Setup, Trigger Setup**, then choose a trigger mode.

In the trigger mode set the delay, peak level and positive or negative edge slope trigger. You can also setup trigger holdoff, auto trigger timing and frame timer settings.

For more details about using PSA Option 122, 80 MHz BW Digitizing Hardware, and PSA Option 140, 40 MHz Digitizing Hardware, including detailed function descriptions, SCPI commands and concepts, see the PSA Basic Mode Guide.

For more details about changing measurement parameters, see [“Waveform \(Time Domain\) Measurement Concepts” on page 633](#)

Using Option B7C Baseband I/Q Inputs

Baseband I/Q Measurements Available for E4406A VSA Series Transmitter Tester

The following measurements can be made using Baseband I/Q inputs:

- Channel Power
- Occupied Bandwidth
- Code Domain
- Modulation Accuracy (Composite EVMRho)
- QPSK EVM
- Power Stat CCDF
- Spectrum (Frequency Domain)
- Waveform (Time Domain)

NOTE

The following measurements can not be made using Baseband I/Q Inputs:

- ACPR (ACLR)
 - Intermodulation
 - Spectrum Emission Mask
 - Multi Carrier Power
-

Baseband I/Q Measurement Overview

Baseband I/Q measurements are similar to RF measurements. To avoid duplication, this section describes only the details unique to using the baseband I/Q inputs. For generic measurement details, refer to the previous “Making Measurements” sections.

To make measurements using baseband I/Q Inputs, make the following selections:

- Select a measurement that supports baseband I/Q inputs. For details see [“Baseband I/Q Measurements Available for E4406A VSA Series Transmitter Tester”](#) on page 169.
- Select the appropriate circuit location and probe(s) for measurements. For details see “Slecting Input Probes for Baseband Measurements in the Concepts chapter. .
- Select baseband I/Q input connectors. For details see Input Port Key Menu in the Key Reference chapter.
- Select just I/Q Setup if desired. For details see IQ Setup Key Menu in the Key Reference chapter.
- Select baseband I/Q input impedance. For details see I/Q Input Z Key Menu in the Key Reference chapter.
- Select a baseband I/Q measurement results view. For details see [“Baseband I/Q Measurement Result Examples”](#) on page 171.

Baseband I/Q Measurement Result Examples

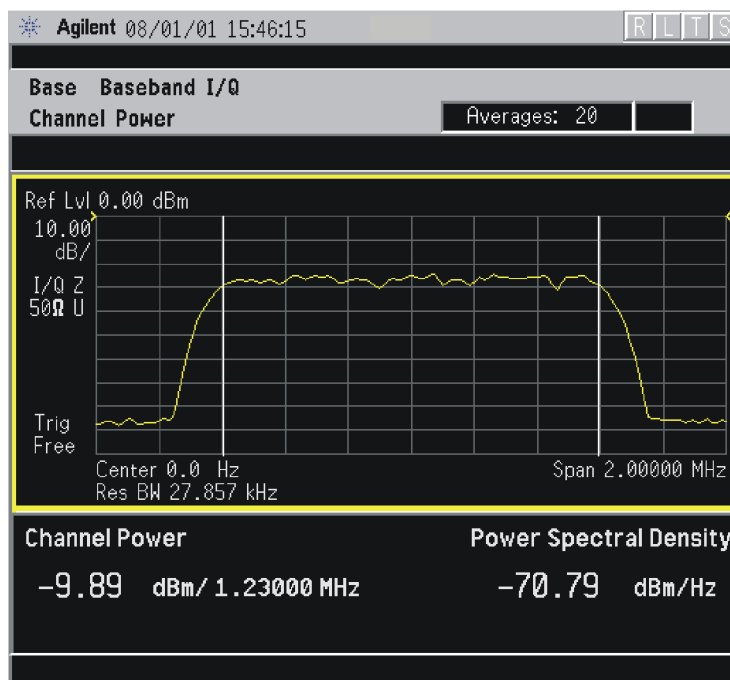
The following are examples of new measurement result displays using baseband I/Q Inputs. A notation below each example indicates the nature of the input signal.

Channel Power Measurement

There is a new view for Channel Power measurements with baseband I/Q Inputs: the Channel Power Spectrum view with 0 Hz center frequency.

This measurement is not available if Input Port menu is set to **I only** or **Q only**, as the total I/Q channel power cannot be measured.

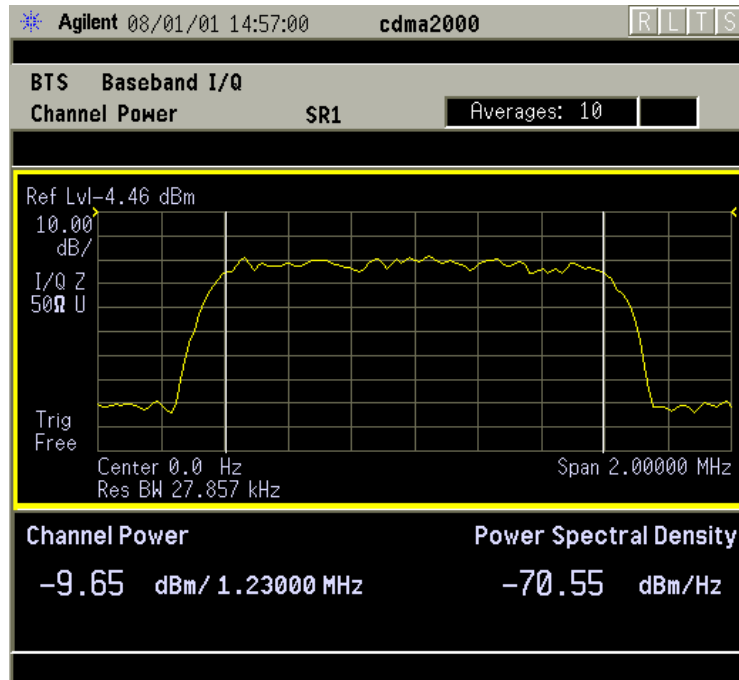
Figure 2-97 Channel Power - Baseband I/Q Inputs



cdma2000 (Rev.8) Downlink, SR1 9 Channel, Baseband I/Q Inputs

Figure 2-98

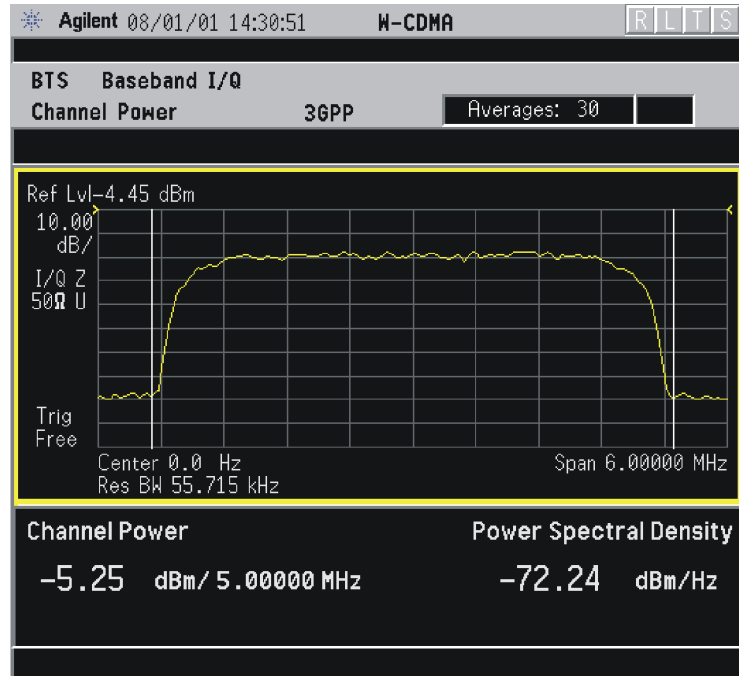
cdma2000 Channel Power - Baseband I/Q Inputs



cdma2000 (Rev.8) Downlink, SR3 9 Channel, Baseband I/Q Inputs

Figure 2-99

W-CDMA Channel Power - Baseband I/Q Inputs



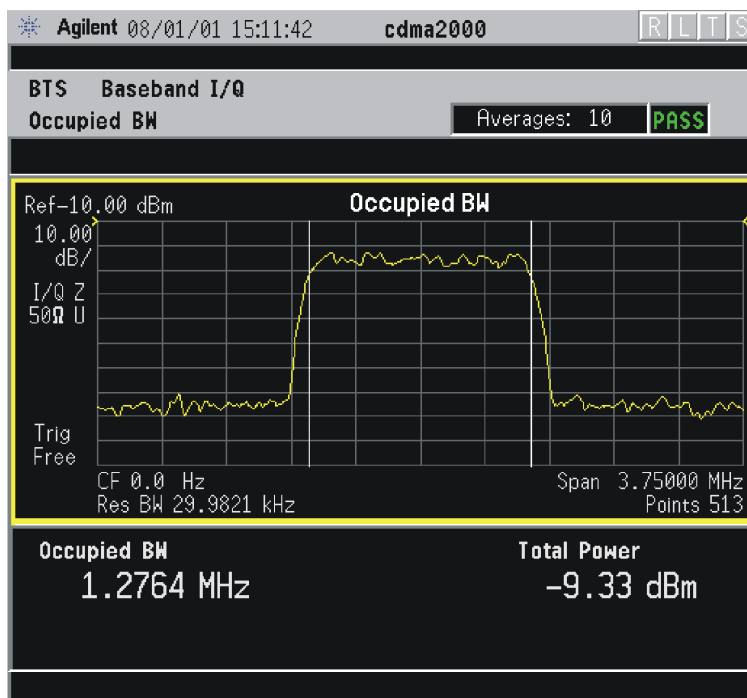
W-CDMA (3GPP 3.4 12-00) Downlink, 1 DCPH, Baseband I/Q Inputs

Occupied Bandwidth Measurement

There is one new view for Occupied Bandwidth measurements with baseband I/Q Inputs: the Occupied BW Spectrum view with 0 Hz center frequency.

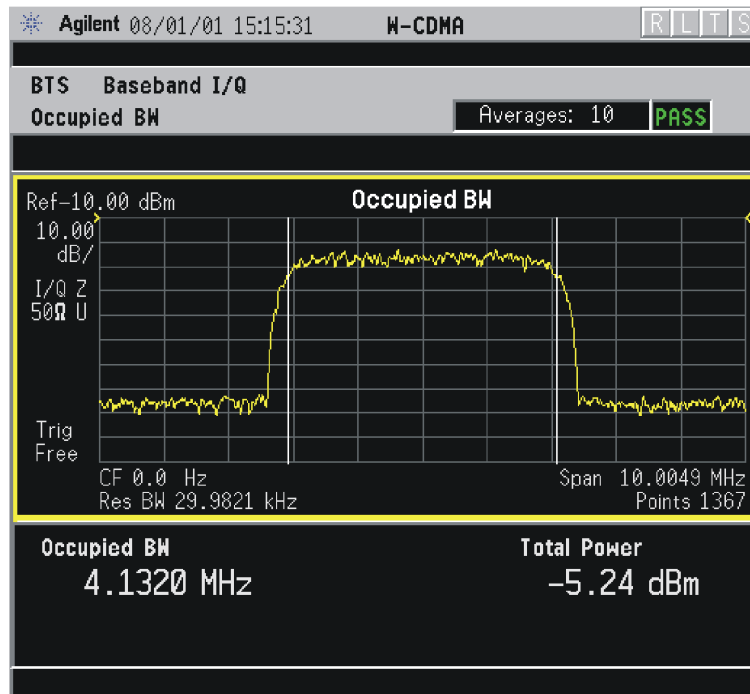
Figure 2-100

cdma2000 Occupied Bandwidth - Baseband I/Q Inputs



cdma2000 (Rev.8) Downlink, SR1 9 Channel, Baseband I/Q Inputs

Figure 2-101 W-CDMA Occupied Bandwidth - Baseband I/Q Inputs



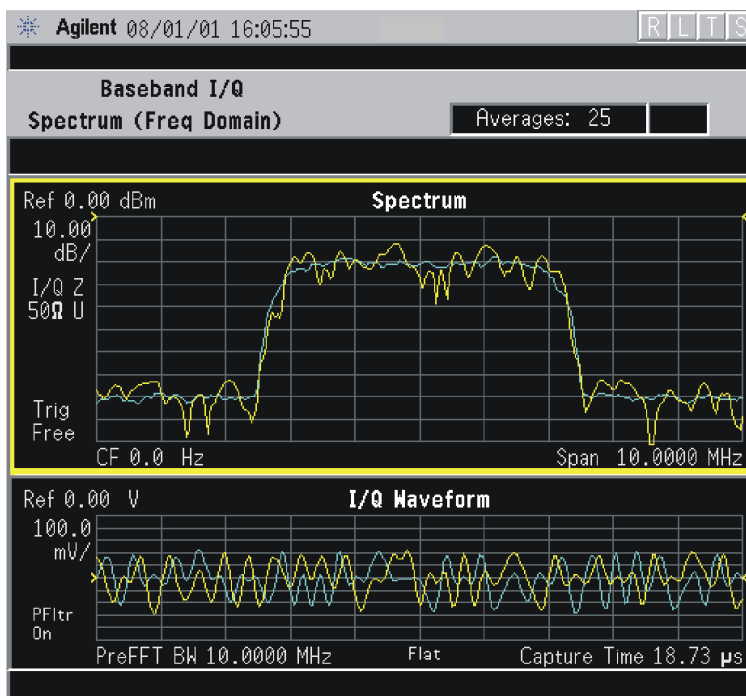
W-CDMA (3GPP 3.4 12-00) Downlink, 1 DCPH, Baseband I/Q Inputs

Spectrum (Frequency Domain) Measurement

There are two new views with baseband I/Q input Spectrum measurements: the Spectrum view with 0 Hz center frequency, and the Spectrum Linear view with 0 Hz center frequency and the vertical scale in volts.

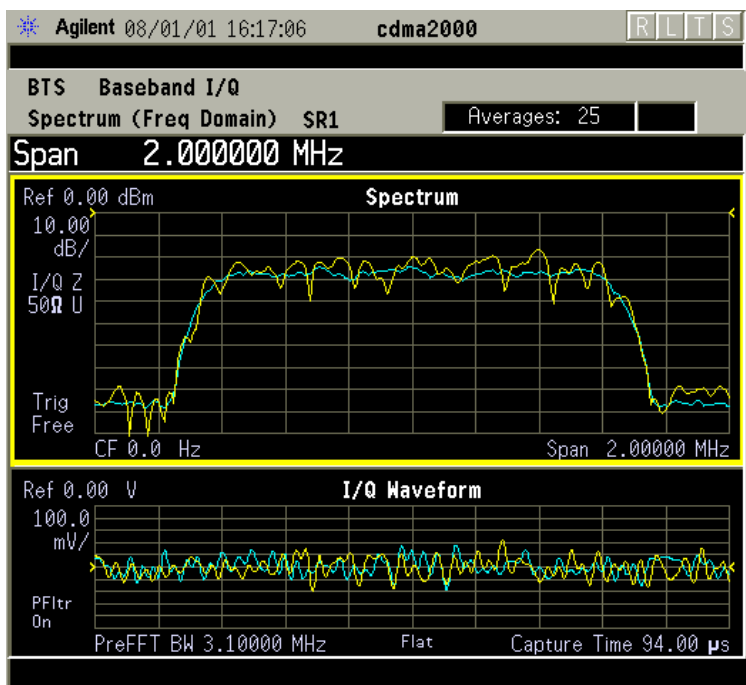
If you have **I only** or **Q only** selected as the **Input Port**, a Spectrum view does not have 0 Hz as the center frequency. It is displayed with 0 Hz at the left margin, similar to a conventional spectrum display, except that the start frequency remains 0 Hz regardless of **Span**, and the center frequency is displayed as half the **Span**.

Figure 2-102 Spectrum View- Baseband I/Q Inputs



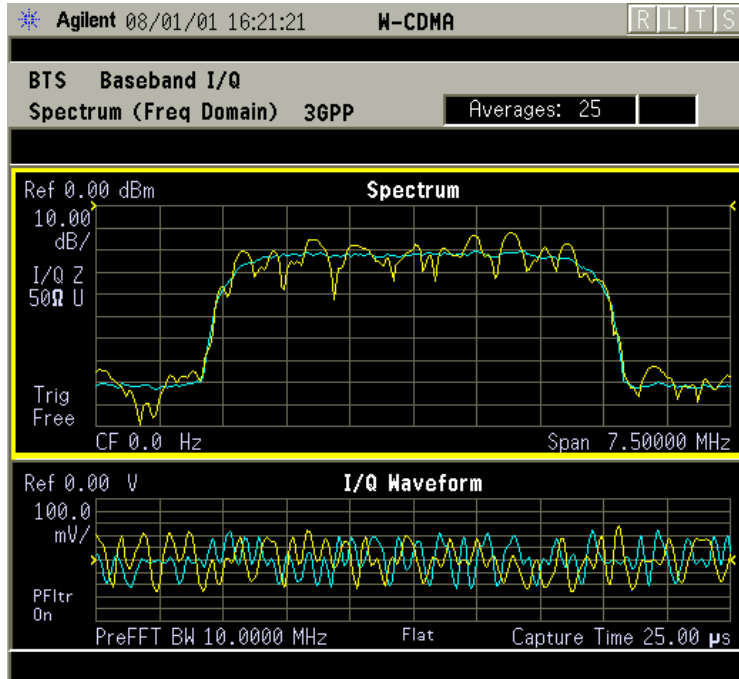
W-CDMA (3GPP 3.4 12-00) Downlink, 1 DCPH, Baseband I/Q Inputs

Figure 2-103 cdma2000 Spectrum View - Baseband I/Q Inputs



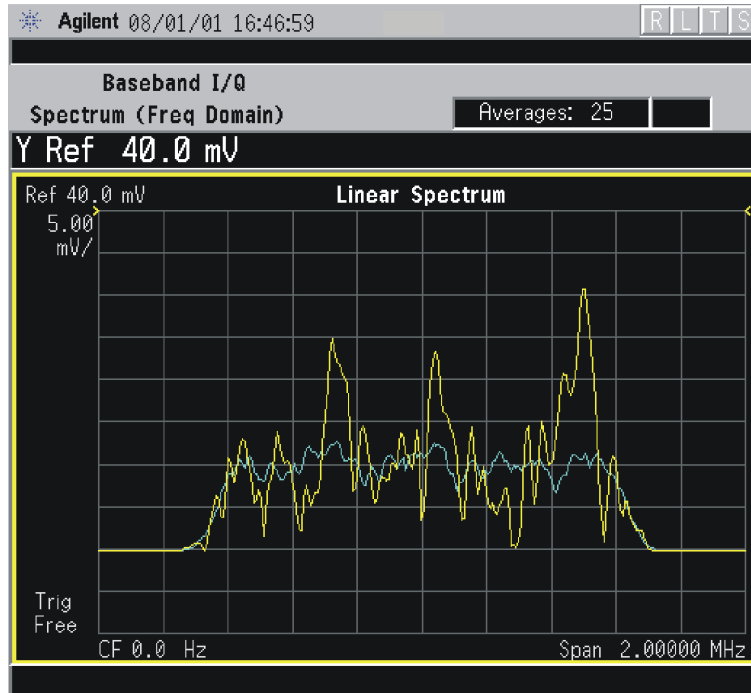
cdma2000 (Rev.8) Downlink, SR1 9 Channel, Baseband I/Q Inputs

Figure 2-104 W-CDMA Spectrum View - Baseband I/Q Inputs



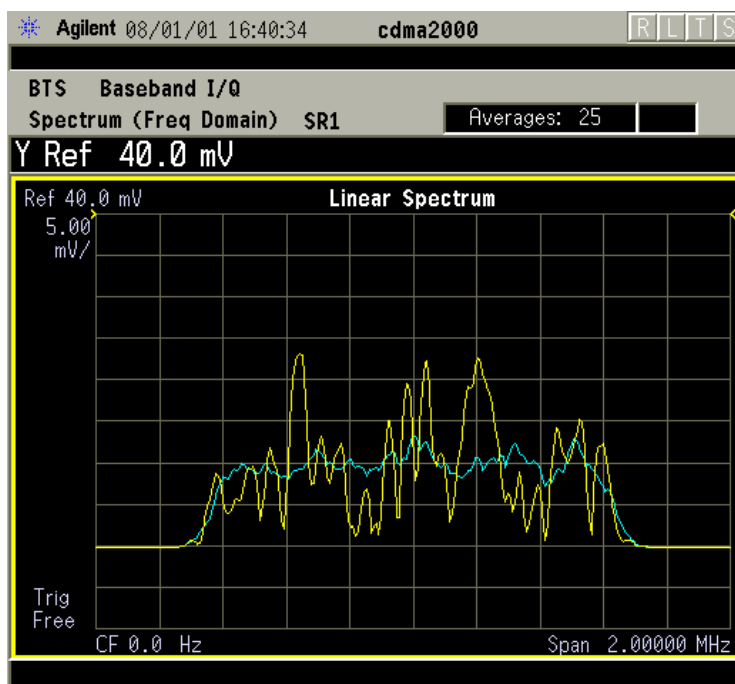
W-CDMA (3GPP 3.4 12-00) Downlink, 1 DCPH, Baseband I/Q Inputs

Figure 2-105 Spectrum Linear View- Baseband I/Q Inputs



W-CDMA (3GPP 3.4 12-00) Downlink, 1 DCPH, Baseband I/Q Inputs

Figure 2-106 cdma2000 Spectrum Linear View - Baseband I/Q Inputs



cdma2000 (Rev.8) Downlink, SR1 9 Channel, Baseband I/Q Inputs

Figure 2-107 W-CDMA Spectrum Linear View - Baseband I/Q Inputs

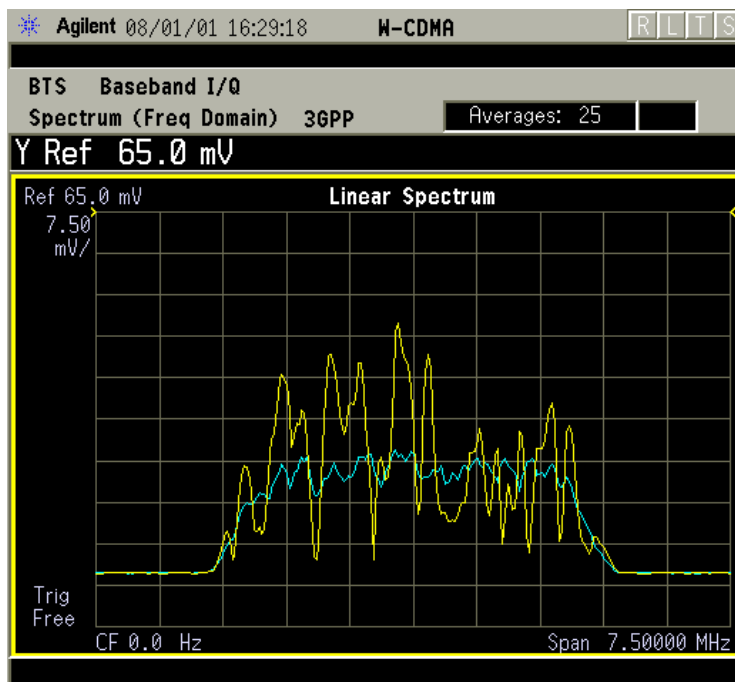
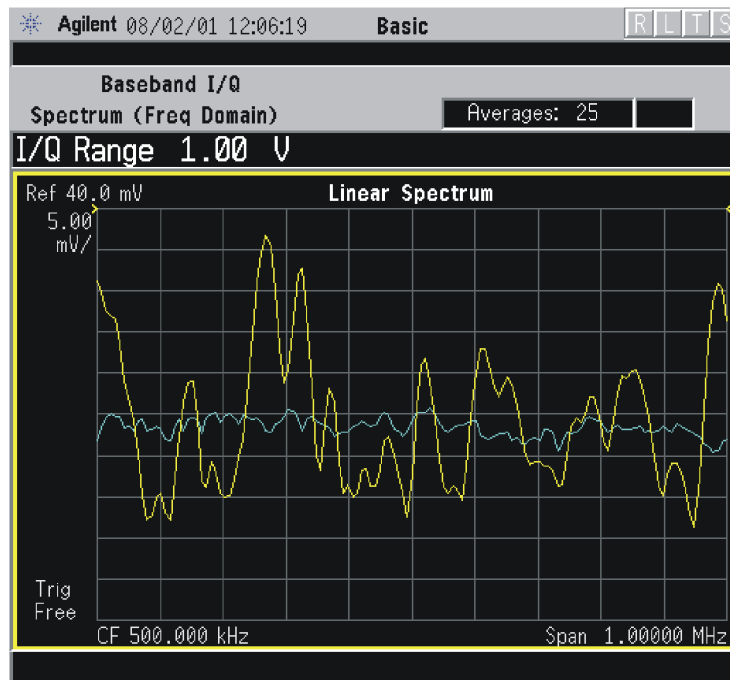


Figure 2-108 W-CDMA (3GPP 3.4 12-00) Downlink, 1 DCPH, Baseband I/Q Inputs

Figure 2-109 Basic Mode Spectrum I only View- Baseband I/Q Inputs



W-CDMA (3GPP 3.4 12-00) Downlink, 1 DCPH, Baseband I/Q Inputs

Waveform (Time Domain) Measurement

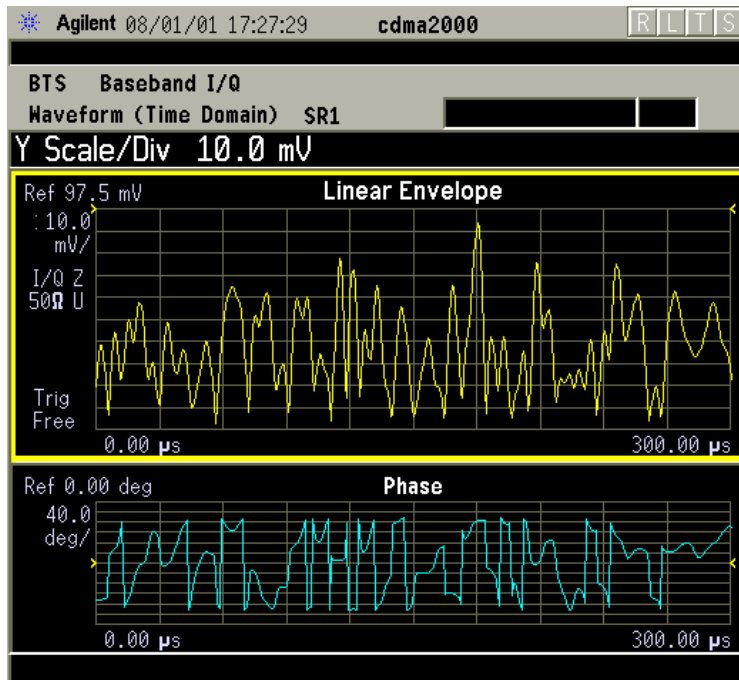
There are two new views with baseband I/Q input Waveform (Time Domain) measurements: the Linear Envelope view with the vertical scale in volts, and the I and Q Waveform view with separate windows for the I and Q traces.

Figure 2-110 Waveform Linear Envelope - Baseband I/Q Inputs



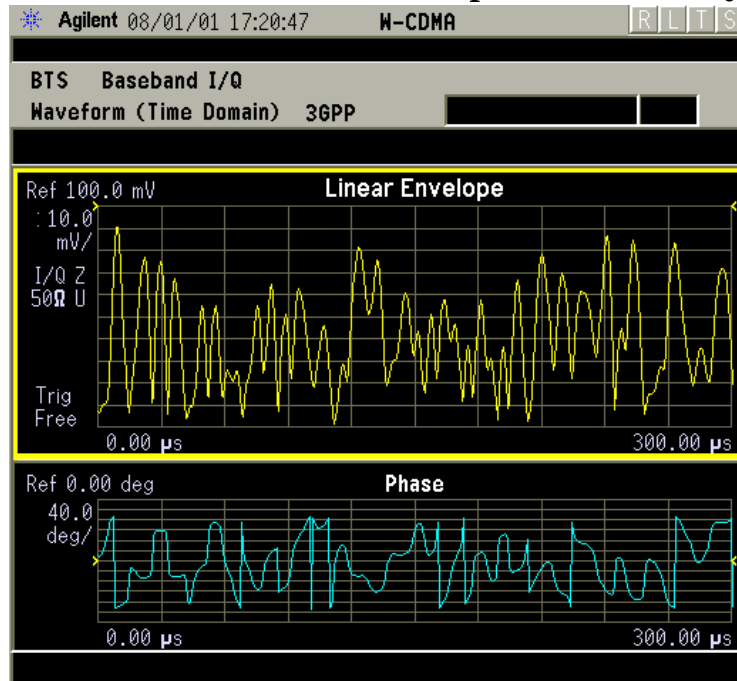
W-CDMA (3GPP 3.4 12-00) Downlink, 1 DCPH, Baseband I/Q Inputs

Figure 2-111 cdma2000 Waveform Linear Envelope - Baseband I/Q Inputs



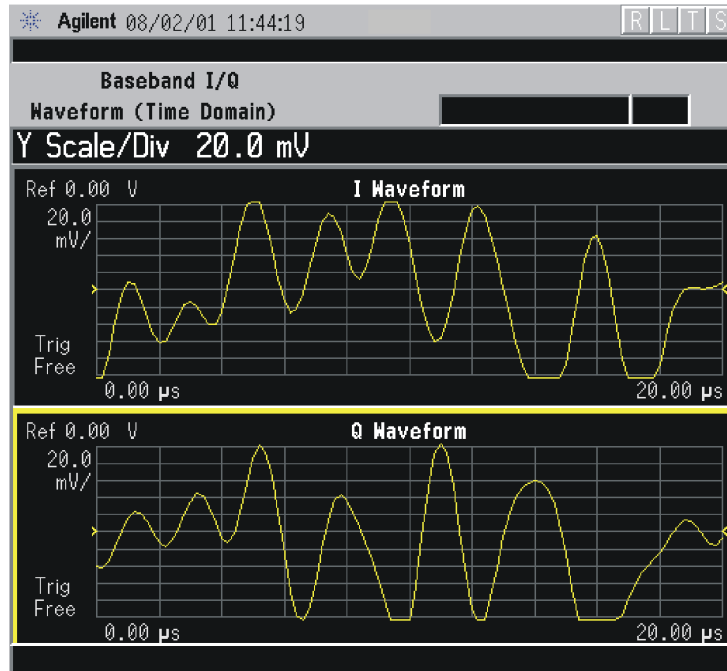
cdma2000 (Rev.8) Downlink, SR1 9 Channel, Baseband I/Q Inputs

Figure 2-112 W-CDMA Waveform Linear Envelope - Baseband I/Q Inputs



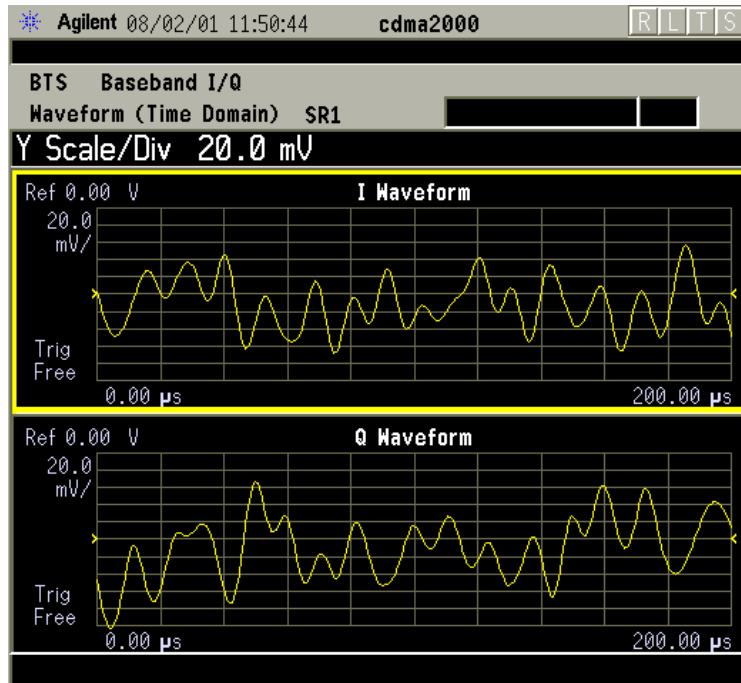
W-CDMA (3GPP 3.4 12-00) Downlink, 1 DCPH, Baseband I/Q Inputs

Figure 2-113 I and Q Waveform View - Baseband I/Q Inputs



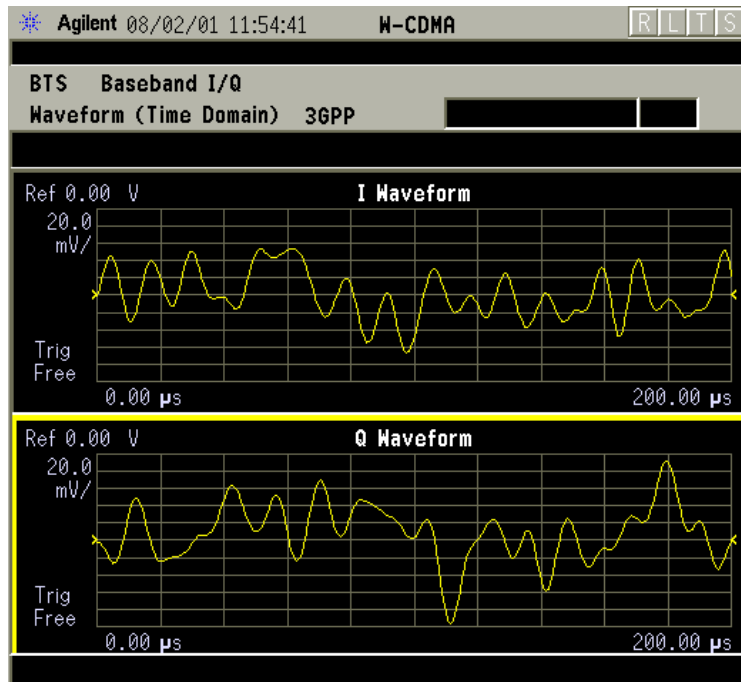
W-CDMA (3GPP 3.4 12-00) Downlink, 1 DCPH, Baseband I/Q Inputs

Figure 2-114 cdma2000 I and Q Waveform View - Baseband I/Q Inputs



cdma2000 (Rev.8) Downlink, SR1 9 Channel, Baseband I/Q Inputs

Figure 2-115 W-CDMA I and Q Waveform View - Baseband I/Q Inputs



W-CDMA (3GPP 3.4 12-00) Downlink, 1 DCPH, Baseband I/Q Inputs

Using Basic Mode

Basic mode is a standard feature of E4406A Transmitter Testers, and is part of Option B7J for the PSA Series Spectrum Analyzers. Basic mode is *not* related to a particular communications standard. That is, it does not default to measurement settings that are for any specific standard. You may want to use Basic Mode if you are making measurements on a signal that is not based on a specific digital communications standard.

Basic Mode in E4406A VSA Series Transmitter Testers

There are five generic measurements available under the **MEASURE** key in Basic mode:

- Adjacent Channel Power (ACP)
- Channel Power
- Power Statistics CCDF
- Spectrum measurement (frequency domain).
- Waveform measurement (time domain)

The ACP, Channel Power, and Power Stat CCDF measurements are fully described in the VSA Series User's Guide. Please refer to that manual for complete information on these measurements.

Spectrum and Waveform Measurements

These measurements provide a spectrum measurement mode that is similar to a standard spectrum analyzer, and a waveform measurement mode that is similar to a microwave oscilloscope. Unlike those standard analyzers, these measurements are optimized for digitally modulated signals, so they can be used to output the measured I/Q data.

For your convenience, Spectrum and Waveform measurements are also available in this mode, with the same functionality, so you can refer to the sections included in this chapter for information about using them.

Basic Mode in PSA Series Spectrum Analyzers

There are two generic measurements available under the **MEASURE** key in Basic mode:

- Spectrum measurement (frequency domain).
- Waveform measurement (time domain)

These Spectrum and Waveform measurements are also available in this mode, with the same functionality, so you can refer to the sections included in this chapter for information about using them.

Interpreting Common Error Codes

During the execution of your measurement you may encounter problems which generate error codes. Reference to the following common errors may be helpful.

If **Err** is shown in the annunciator bar, press the **System, Show Errors** hard and soft keys to read detailed error information.

- **Error Code 16 “Input overload”**

This error means that your measurement has erroneous results due to an excessive input power level. To correct this condition, the input signal level must be reduced by using the internal and/or external attenuators.

Press the **Mode Setup, Input, Input Atten** keys to enter an attenuation value to reduce the transmitted power from the MS using the internal attenuator. The allowable range is up to 40 dB.

If you want to attenuate more than 40 dB, connect your external attenuator between the **RF INPUT** port and the UUT. Press the **Mode Setup, Input, Input Atten** and select **MS** or **BTS** keys to enter the attenuation value. The allowable range is up to ± 100 dB. The analyzer will automatically add its attenuation value to the readings of the measurement result.

To automate this calculation, press the **Mode Setup, Input, Ext Atten** keys to enter the additional attenuation value. The allowable range is up to 100 dB. The power readings of the measurement will take into account the external attenuation value.

- **Error Code 501 “Signal too noisy”**

This error means that your input signal is too noisy to capture the correct I/Q components. To make a more stable measurement the trigger source may need to be set to **Frame**, for example.

- **Error Code 503 “Can not correlate to input signal”**

This error means that the instrument has failed to find any active channels in the input signal as specified. To improve the correlation some critical parameter needs to be adjusted, like the input signal level or scramble code, for example.

For more details consult the chapter in this book dedicated to the measurement in question, or “Instrument Messages and Functional Tests” manual.

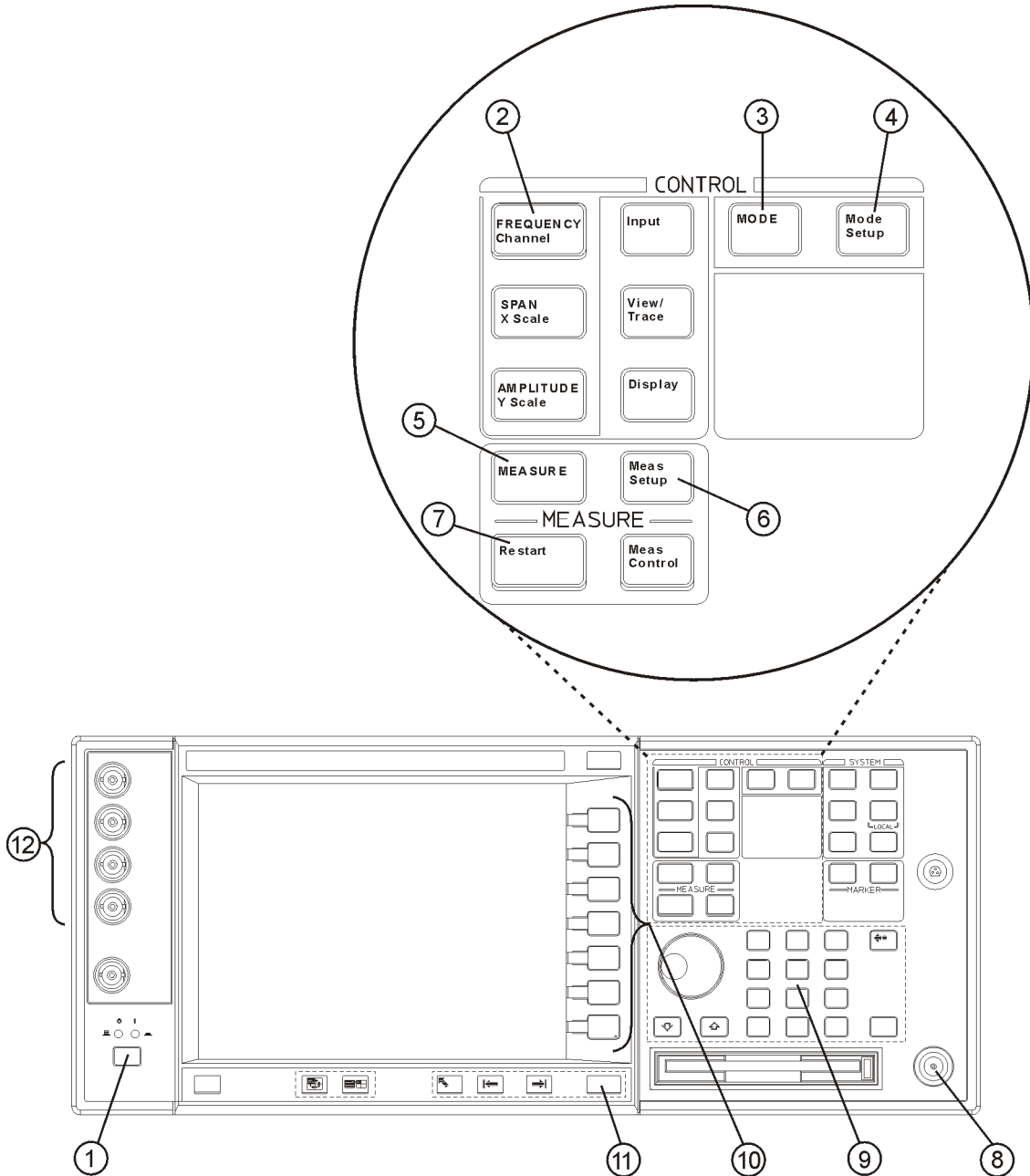
3 Key Reference

This chapter provides detailed descriptions of the keys used to set up and make W-CDMA measurements, including **Mode Setup**, **Meas Setup**, and **MEASURE**. Keys that allow you to see different presentations of the measurement results are also described, including **View/Trace**, and **Display**, showing the associated screens.

Instrument Front Panel Highlights

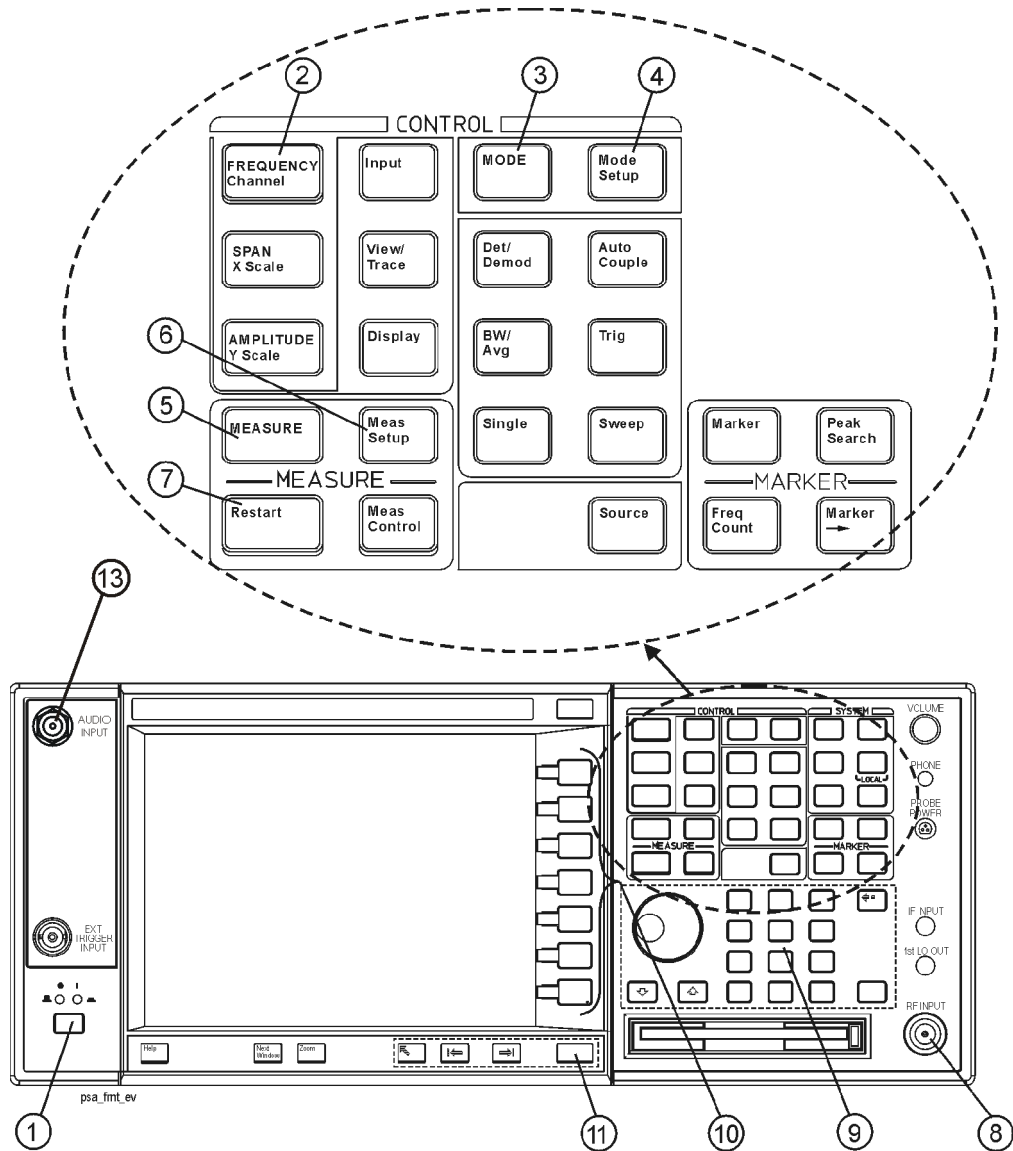
The most commonly used function keys on the VSA and PSA front panels are located as shown in the illustrations below. The operation of the keys is briefly explained on the following page. Refer to your User's Guide for complete details on all keys.

Figure 3-1 Selected E4406A VSA Series Front Panel Feature Locations



aa81a

Figure 3-2 Selected PSA Series Front Panel Feature Locations



Selected E4406A VSA and PSA Front-Panel Features

1. The **On/Off** switch toggles the AC Line power between On and Standby. A green LED will light when the instrument is On. When energized in the standby mode, a yellow LED is lit above the switch.
2. **FREQUENCY Channel** accesses a key menu to set the analyzer center frequency in units of Hz, kHz, MHz, or GHz, or by channel number. These parameters apply to all measurements in the current mode.
3. **MODE** accesses a key menu to select one of the measurement personalities installed in the instrument. Each mode is independent from all other modes.
4. **Mode Setup** accesses a key menu that sets parameters specific to the current mode and can affect all measurements within that mode.
5. **MEASURE** accesses a display key menu to initiate one of the various measurements that are specific to the current mode.
6. **Meas Setup** accesses the menus of test parameters that are specific to the current measurement.
7. **Restart** causes a measurement to start again from the initial process according to the current measurement setup parameters.
8. **RF INPUT** port: Type N connector for the E4406A VSA and E4443A, E4445A, and E4440A PSAs. It is 2.4mm on the E4446A and E4448A PSAs. It is a 3.5mm connector on all PSAs with Opt BAB. The maximum input power level is shown next to the port.
9. The **Data Entry** keypad is used to enter numeric values. Keypad entries are displayed in the active function area of the screen and become valid for the current measurement upon pressing the **Enter** key or selecting a unit of measurement, depending on the parameter.

10. The Display Menu keys allow you either to activate a feature or to access a more detailed sub-menu. An arrow on the right side of a softkey label indicates that the key has a further selection menu. The active menu key is highlighted, however, grayed-out keys are currently unavailable for use or only show information. If a menu has multiple pages, successive pages are accessed by pressing the **More** key located at the bottom of the menu.
11. Pressing the **Return** key allows you to exit the current menu and display the previous menu. Often, pressing a menu key will invoke a multi-page sub-menu. Pressing the **Return** key will show the menu “above” it, not a previous page. When you activate another measurement, the return list is cleared. The **Return** key will not return you to a previously activated mode, nor will it alter any values you have entered in previous menus.
12. **Baseband I/Q Inputs** (E4406A Option B7C only) Allow you to analyze signals at baseband frequencies. See [“Using Option B7C Baseband I/Q Inputs” on page 1.](#)
13. **BNC Audio Input** (PSA Option 233 Measuring Receiver only) Provides a 100 kOhm input for audio measurements. Frequency range is 20 Hz to 250 kHz. Safe input level is 7 Vrms or 20 V DC.

Front Panel Keys

NOTE Only front panel keys affected by selection of W-CDMA mode are described here. For a complete description of all front panel keys see the E4406A VSA or PSA Series User's Guide.

FREQUENCY Channel Key Menu

Key path: **FREQUENCY Channel**

- **Center Freq** - Allows you to enter a frequency that corresponds to the desired RF channel to be measured. This is the current instrument center frequency. The range is 1.000 kHz to 4.32140 GHz with 1 Hz resolution.
- **CF Step** - Allows you to enter a center frequency step to shift the measurement segment, and to toggle the step function between **Auto** and **Man**. If set to **Auto**, the **CF Step** value automatically changes according to the selection of the standard. The range is 1.000 kHz to 1.00000 GHz with 1 Hz resolution.

FREQUENCY Channel Default Settings	
FREQUENCY Channel:	
Center Freq	1.00000 GHz
CF Step	5.00000 MHz, Auto

NOTE For E4406A, Option B7C, if **Input Port** is set to **I/Q**, the **Center Freq** and **CF Step** keys are disabled as the baseband I/Q signal frequencies are centered at 0 Hz.

MEASURE Key Menu

Key path: **MEASURE**

- **Channel Power** - Press this key to activate channel power measurements. This is the in-channel power measurement. The channel power graph is displayed in the graph window and both the absolute channel power and mean power spectral density are shown in the text window.
- **ACPR (ACLR)** - Press this key to activate adjacent channel power ratio (ACPR) measurements. This is also called Adjacent Channel Leakage power Ratio (ACLR). This is the out-of-channel power measurement. The following windows are available:
 - Bar graph display to show a histogram of powers within the channel integration bandwidth
 - Spectrum display to show a power distribution curve, like a swept-frequency spectrum analyzer, relative to the center frequency power of the carrier signal
- **Intermod** - Press this key to activate intermodulation products measurements. Three measurement modes are available as follows:
 - Auto - Automatically identifies one of two modes between two-tone or transmit intermodulation products.
 - Two-tone Measurements are made supposing two signals to be the tone signals.
 - Transmit IM - Measurements are made supposing the lower frequency signal to be the modulated transmitting signal and the upper frequency signal to be the tone signal.

NOTE

For E4406A, Option B7C, this measurement is not available when using Baseband IQ inputs.

- **Multi Carrier Power** - Press this key to activate multi carrier power measurements. All power levels of two input carriers, the channels between them, and out-of-channels from them are measured by applying two input carriers of which offset should be either 5 MHz, 10 MHz, or 15 MHz. The third, fifth, and seventh order intermodulation products can be measured by setting the measurement mode.

For E4406A, Option B7C, this measurement is not available when using Baseband IQ inputs.

- **Spectrum Emission Mask** - Press this key to activate spectrum emission mask measurements. The measurement mask is configurable with flat and sloped lines according to the radio specifications. **Spurious Emission** measurements can be done with some restrictions of the upper frequency bandwidth by selecting **Region** in **Spectrum Segment**.

NOTE

For E4406A, Option B7C, this measurement is not available when using Baseband IQ inputs.

- **Occupied BW** - Press this key to activate occupied bandwidth measurements. The frequency bandwidth that contains 100.0% of the total power is measured first, and then 99.0% of the frequency bandwidth is calculated as the measurement result.
- **CDP Graph and CDE Graph** - Provides a combination view of the code domain power graph and code domain error graph as shown in [Figure 3-13 on page 245](#). This selection is not available if **Capture Intvl** is set to Long Mode.
- **Code Domain** - Press this key to activate code domain power (CDP) measurements. The amount of power in each code channel is displayed. The following windows are available:
 - Power graph and metrics to show the code domain power and the summary data
 - Quad view of the I/Q errors in graphs for the spread rate selected, and the summary data
 - Quad view of the code domain power, the selected symbol power vs. symbol rate, and the selected symbol EVM polar vector graphs, and the summary data
 - Triad view of the code domain power and the selected symbol power graphs, and the selected demodulated bits stream text
- **Mod Accuracy (Composite EVM)** - Press this key to activate modulation accuracy (composite EVM) measurements. The input signal should contain only the Perch channel. This is essentially a code domain power measurement with one active channel. The following windows are available:
 - Polar Vector Constellation view displays a graph of the I/Q demodulated signals and the summary data
 - I/Q Error (Quad View) displays graphs of the demodulated signals, showing Magnitude Error, Phase Error, EVM, and the summary data.
 - Code Domain Power (Triad View) displays graphs of power across spread codes, I/Q Measured Polar Vector, and summary data.

- Peak/Avg Metrics view shows a tabular summary of Rho, with all I/Q, EVM, Code Domain, Phase, and Frequency errors.
- Capture Intvl - Allows you to access a menu to set the signal capture length for a code domain power measurement.
- Slot CDE/EVM - Provides a combination view of frequency error, peak Code Domain error, and an EVM graph for slot-by-slot results (as shown [Figure 3-23](#)).
- **QPSK EVM** - Press this key to activate QPSK error vector magnitude (EVM) measurements. The following windows are available:
 - Polar vector graph of the I/Q demodulated signals and the summary data
 - Polar constellation graph of the I/Q demodulated signals and the summary data
 - Quad view of the I/Q errors in graphs and the summary data
- **Power Stat CCDF** - Press this key to activate power statistics Complementary Cumulative Distribution Function (CCDF) measurements. This is helpful to observe the time domain characteristics of a spread spectrum signal that can significantly affect the ACPR measurement results for a given UUT.
- **Spectrum (Freq Domain)** - Press this key to activate frequency domain spectrum measurements. The following windows are available:
 - Spectrum graph with semi-log graticules and I/Q waveform graph with linear graticules
 - Linear spectrum graph with linear graticules
 - I and Q waveform graphs with linear graticules
 - I/Q polar graph with linear graticules
- **Waveform (Time Domain)** - Press this key to activate time domain waveform measurements. The following windows are available:
 - Signal envelope graph with semi-log graticules and the summary data
 - Linear envelope graph and phase graph with linear graticules and the summary data
 - I/Q waveform graph with linear scale graticules
 - I and Q waveform graph for the baseband I/Q input signals and the summary data (E4406A, Option B7C only)
 - I/Q polar graph with linear scale graticules

Key Reference

Front Panel Keys

- **Pwr Control** - Press this key to activate uplink power control measurements. The following windows are available:
 - Slot Power display using a Power versus Time graph and summary data summary data
 - PRACH Power graph display using a Power versus Time graph and summary data summary data
- **Pwr vs Time** - Press this key to activate Power versus Time Mask measurements. The following window is available:
 - RF Envelope display using a Power versus Time graph and summary data summary data

Meas Control Key Menu

Key path: **Meas Control**

- **Restart** - Press this key to repeat the current measurement from the beginning, while retaining the current measurement settings. This is equivalent to the **Restart** front panel key.
- **Measure**- Press this key (not to be confused with the **MEASURE** front panel key which has a different function) to toggle the measurement state between **Single** and **Cont** (continuous). When set to **Single**, the measurement will continue until it has reached the specified number of averages set by the average counter. When set to **Cont**, the measurement will run continuously and execute averaging according to the current average mode, either repeat or exponential. The default setting is **Cont**, except for code domain and power statistics CCDF measurements, for which the default is **Single**.
- **Pause** - Press this key to pause the current measurement until you reactivate the measurement. Once toggled, the label of the **Pause** key changes to read **Resume**. The **Resume** key, once pressed, continues the active measurement from the point at which it was paused.

Mode Setup Key Menu

Key path: **Mode Setup**

Radio Key Menu

Key path: **Mode Setup, Radio**

- **Device** - Allows you to toggle the test device between **BTS** (Base Transmission Station) and **MS** (Mobile Station).

Radio Default Setting	
Device	BTS

Input Key Menu

Key path: **Mode Setup, Input**

NOTE

You can also access this menu from the **Input/Output** front panel key. For details on the **Input** key see: [“Input/Output Key Menu” on page 204.](#)

- **Input Port** - Allows you to access the menu to select one of the signal input ports as follows:
 - **RF** - Allows you to measure the RF signal supplied to the **RF INPUT** port.
 - **I/Q** - (For E4406A, requires Option B7C.) Allows you to make measurements on the baseband I/Q signals supplied to the I/Q input ports.
 - **I only** - Allows you to make measurements on a baseband I signal supplied to the front panel I or I input port (VSA Basic mode only).
 - **Q only** - Allows you to make measurements on a baseband Q signal input to the Q or Q input port (VSA Basic mode only).
 - **50 MHz Ref** - (For E4406A) Allows you to measure the 50 MHz reference signal to calibrate the instrument.
 - **Amptd Ref (f=50 MHz)** - (For PSA) Allows you to measure the 50 MHz reference signal to calibrate the instrument.
 - **IF Align** - Allows you to configure the IF alignment signal. The RF path is switched to bring in the same alignment signal that is automatically switched to perform many alignments.
 - **Baseband Align Signal** - (For E4406A) Selects an internal signal used for alignment of Option B7C baseband inputs.

Key Reference
Front Panel Keys

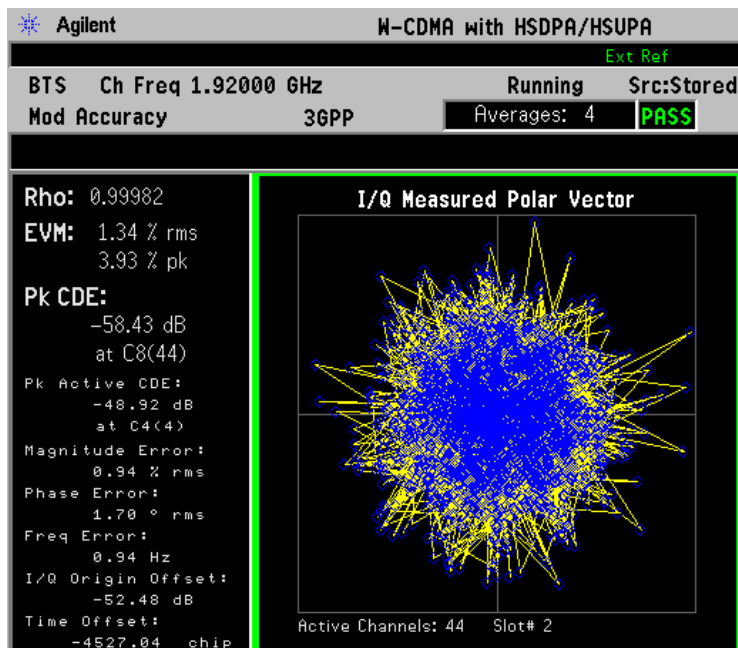
- **Data Source** - Enables sharing of raw data between Code Domain and Modulation Accuracy measurements, as long as critical measurement parameters are compatible. Data Sharing allows a single measured data set to be used to calculate results of both measurements.
 - **Input** - (Default) Signals applied to the RF Input will be measured.
 - **Stored** - Press this key to use stored data from either a Code Domain or Modulation Accuracy measurement measurement. (See **Store Capture** below). When the complimentary measurement is then selected, the displayed result will be based on the same raw data as the first measurement, as long as the measurement parameters for Capture Interval, Measurement Control, and Averaging are identical. If the capture length of the stored data is greater than the capture length of the subsequent measurement, the data will be truncated. If the capture length of the stored data is less than the capture length of the subsequent measurement, the capture length will be reset to match the data. See [Table 3-1](#) for more measurement compatibility interactions.
 - **Store Capture** - Press this key to store current data in instrument memory for sharing . When this key is pressed, **Data Source** is automatically set to **Stored**.
 - **Clear Capture** - Press this key to clear the internal memory of the instrument.

When a measurement is made on a shared data set, the letters “Src:Stored” appear in the upper right hand corner of the display. See [Figure 3-3](#).

NOTE

After completing a shared measurement, you must select **Input, Data Source, Input** to obtain signals at the RF Input for new measurements.

**Figure 3-3 Mod Accuracy Measurement - (BTS) with Data Sharing Enabled
“Src: Stored” Displayed at Top Right Corner**



NOTE

Data can be shared only between Modulation Accuracy and Code Domain measurements. In the table below, “Meas A” refers to the first of a pair of shared data measurements, either Modulation Accuracy or Code Domain. “Meas B” refers to the subsequent complementary measurement performed using the same data set.

Table 3-1

Data Sharing - Measurement Setup Parameter Compatibility

Meas. Parameter	Setting Relationships	Data Sharing Effect
Capture Interval	Meas B = Meas A	Raw data is shared.
	Meas B < Meas A	Meas A data is truncated to fit Meas B setting.
	Meas B > Meas. A	Meas B capture interval, meas offset, and Meas interval settings are overridden- Meas A setting takes effect.

Key Reference
Front Panel Keys

- **I/Q Setup** - (For E4406A, Option B7C) Allows you to access the menu to select the input impedance for the baseband I/Q input signals, and to set the dc offset voltages for I/Q input signals. This key is grayed out unless **Input Port** is set to either **I/Q**, **I only**, or **Q only**.
 - **I Offset** - Allows you to set a dc offset voltage value for the I input signal. The range is 0.0000 to 2.5600 V in 0.0001 V.
 - **Q Offset** - Allows you to set a dc offset voltage value for the Q input signal. The range is 0.0000 to 2.5600 V in 0.0001 V.
 - **I/Q Input Z** - Allows you to access the menu to select one of the input impedances for baseband I/Q input signals as follows:
 - 50 Ω Unbalanced** - Allows you to set the input impedance to unbalanced 50 Ω for use with the I/Q input ports. This is the default setting.
 - 600 Ω Balanced** - Allows you to set the input impedance to balanced 600 Ω for use with the I/Q input ports and the I/Q input ports.
 - 1 M Ω Unbalanced** - Allows you to set the input impedance to 1 M Ω for use with the I/Q input ports.
 - 1 M Ω Balanced** - Allows you to set the input impedance to 1 M Ω for use with the I/Q input ports and the I/Q input ports.
 - **I/Q Z Ref** - Allows you to enter a numeric value to set the reference impedance if **I/Q Input Z** is set to 1 M Ω , otherwise this key is grayed out. The range is x.x to y.y MW in z.z MW.
- **RF Input Range** - Allows you to toggle the input range control for the RF signal between **Auto** and **Man** (manual). If **Auto** is chosen, the instrument automatically sets the attenuator, based on the carrier power level where it is tuned.

For example, once you change the **Max Total Pwr** or **Input Atten** value with the RPG knob the **Input Range** key is automatically set to **Man**. If there are multiple carriers present, the total power might overdrive the front end. In this case you need to set the **Input Range** to **Man** and enter the expected maximum total power by activating the **Max Total Pwr** key. **Man** is also useful to hold the input attenuation constant for the best relative power accuracy. For single carriers it is recommended that you set this to **Auto**.

For PSA, when you use the internal preamplifier, Int Preamp, the selections using the **RF Input Range** key are not available, and the key is greyed-out.

For E4406A, Option B7C, if **Input Port** is set to **I/Q** this key is grayed out

- **Max Total Pwr** - Allows you to set the maximum total power level from the UUT (Unit Under Test). The range is -200.00 to 100.00 dBm with 0.01 dB resolution. This is the expected maximum value of the mean carrier power referenced to the output of the UUT; it may include multiple carriers. The **Max Total Pwr** setting is coupled together with the **Input Atten** and **Ext Atten** settings. Once you change the **Max Total Pwr** value with the RPG knob, for example, the **RF Input Range** key is automatically set to **Man**.

For PSA, when you use the internal preamplifier, Int Preamp, the selections using the **Max Total Pwr** key are not available, and the key is greyed-out.

For E4406A, Option B7C, when **Input Port** is set to **I/Q**, this key label changes to **I/Q Range**. It controls the maximum input voltages of the baseband I/Q input signals. The ranges are 130.0 mV, 250.0 mV, 500.0 mV and 1.0 V.

- **Input Atten** - Allows you to control the internal input attenuator setting. The range is 0 to 40 dB with 1 dB resolution. The **Input Atten** key shows the actual hardware value that is used for the current measurement. If more than one input attenuator value is used in a single measurement, the value used at the carrier frequency will be displayed. The **Input Atten** setting is coupled to the **Max Total Pwr** setting. Once you change the **Input Atten** setting with the RPG knob, for example, the **RF Input Range** key is automatically set to **Man**.

For PSA, when you use the internal preamplifier, Int Preamp, the electronic attenuator selections using the **Input Atten** key are not available, and the key is greyed-out. Use the mechanical attenuator under **More 1 of 2, Attenuator**, below.

For E4406A, Option B7C, this attenuator is located in front of the first down converter, therefore it is cannot be used for the baseband I/Q input signals.

- **Ext Atten** - Allows you to access the following menu to enter the external attenuation values. Either of the **Ext Atten** settings is coupled together with the **RF Input Range** setting, however, pressing **Ext Atten** does not switch the **RF Input Range** key to **Man**. This will allow the instrument to display the measurement results referenced to the output of the UUT.
 - **MS** - Allows you to set an external attenuation value for MS tests. The range is -50.00 to $+50.00$ dB with 0.01 dB resolution.
 - **BTS** - Allows you to set an external attenuation value for BTS tests. The range is -50.00 to $+50.00$ dB with 0.01 dB resolution.

- **Int Preamp** - (For PSA, requires Option 1DS) Allows you to control the internal RF input preamplifier. The internal preamplifier provides +30 dB of gain and is useful for lower power measurements. The **Int Preamp** setting default is **Off**. RF power values displayed for these measurements are adjusted to compensate for the internal preamplifier gain, and indicate power levels at the input port. The preamplifier is only available for Modulation Accuracy (EVM and Peak Code Domain Error) measurements, QPSK EVM, and Code Domain measurements. If the **Int Preamp** is not available for a particular measurement, the key is greyed-out.

To avoid damaging the internal preamplifier, limit the total power applied to the RF input to $\leq +25\text{dBm}$.

When using the internal preamplifier, the electronic attenuator selections using the **Input Atten** key are not available, and the key is greyed-out. Use the mechanical attenuator under **More 1 of 2, Attenuator**, below.

- **Attenuator** - (For PSA, requires Option 1DS) When **Int Preamp** is set to **On**, this key allows you to control an internal mechanical input attenuator setting. The settings available are 0 dB, 10 dB, or 20 dB. The **Attenuator** key shows the actual hardware value that is used for the current measurement. The **Attenuator** setting is not coupled to the **Max Total Pwr** setting.

The **Attenuator** is only available for measurements which can use the **Int Preamp**: Modulation Accuracy (EVM and Peak Code Domain Error) measurements, QPSK EVM, and Code Domain measurements. If the **Int Preamp** is not available for a particular measurement, the key is greyed-out.

NOTE

The **Max Total Pwr** and **Input Atten** settings are coupled together, so changing the input **Max Total Pwr** setting by x dB changes the **Input Atten** setting by x dB. When you switch to a different measurement, the **Max Total Pwr** setting is kept constant, but the **Input Atten** may change if the two measurements have different mixer margins. Therefore, you can set the input attenuator manually, or you can set it indirectly by specifying the expected maximum power from the UUT.

Input Default Settings	
Input Port	RF
Data Source	Input
I/Q Setup ^a (E4406A, Option B7C only)	(disabled)
RF Input Range	Auto ^b
Max Total Pwr	-15.00 dBm ^c
Input Atten	0.00 dB ^c
Ext Atten: MS BTS	0.00 dB 0.00 dB
Int Preamp ^d (PSA only):	OFF

- a. This key is grayed out if **Input Port** is set to **RF**.
- b. Auto is not available for Spectrum measurements.
- c. This may differ if the maximum input power is more than -15.00 dBm, or depending on the previous measurements.
- d. The preamplifier is only available for Modulation Accuracy (EVM and Peak Code Domain Error) measurements, QPSK EVM, and Code Domain measurements.

Trigger Key Menu

The **Trigger** key allows you:

- (1) to access the trigger selection menu to specify each triggering condition,
- (2) to modify the default trigger holdoff time using **Trig Holdoff**,
- (3) to modify the auto trigger time and to activate or deactivate the auto trigger feature using **Auto Trig**, and
- (4) to modify the period of the frame timer using **Frame Timer**.

NOTE

The actual trigger source is selected separately for each measurement under the **Meas Setup** key.

- **RF Burst, Video (Envlp), Ext Front, Ext Rear**- Pressing one of these trigger keys will access each triggering condition setup menu. This menu is used to specify the **Delay**, **Level** and **Slope** settings for each trigger source as follows:
 - **Delay** - Allows you to enter a numerical value to modify the trigger delay time. The range is -100.0 to $+500.0$ ms with $1\ \mu\text{s}$ resolution. For trigger delay use a positive value, and for pre-trigger use a negative value.
 - **Level** - Allows you to enter a numerical value to adjust the trigger level depending on the trigger source selected.
 - For **RF Burst** selection, the key label is **Peak Level**. The RF level range is -25.00 to 0.00 dB with 0.01 dB resolution, relative to the peak RF signal level. The realistic range can be down to -20 dB.
 - For **Video (Envlp)** selection, the video level range is -200.00 to $+50.00$ dBm with 0.01 dB resolution at the RF input. The realistic range can be down to around -50 dBm depending on the noise floor level of the input signal.
 - For **Ext Front** or **Ext Rear** selection, the level range is -5.00 to $+5.00$ V with 1 or 10 mV resolution.
 - **Slope** - Allows you to toggle the trigger slope between **Pos** at the positive-going edge and **Neg** at the negative-going edge of the burst signal.

There are other keys under the **Trigger** key as follows:

- **Trig Holdoff** - Allows you to set the period of time before the next trigger can occur. The range is $0.000\ \mu\text{s}$ to 500.0 ms with $1\ \mu\text{s}$ resolution.
- **Auto Trig** - Allows you to specify a time for a trigger timeout and toggle the auto trigger function between **On** and **Off**. The range is 1.000 ms to 1.000 ks with $1\ \mu\text{s}$ resolution. If no trigger occurs by the specified time, a trigger is automatically generated.
- **Frame Timer** - Allows you to access the menu to manually control the frame timer:
 - **Period** - Allows you to set the period of the frame clock. The range is 0.000 ns to 559.0000 ms with 1 ps resolution.
 - **Offset** - Allows you to set the offset of the frame clock. The range is 0.000 to 10.00 s with 100 ns resolution over $1.000\ \mu\text{s}$ range.
 - **Reset Offset Display** - Allows you to display without any offset of the frame clock.
 - **Sync Source** - Allows you to access the menu to select one of the sources to be synchronized with.

Off - Allows you to turn the synchronizing source off for asynchronous tests.

Ext Front - Allows you to select the external input signal from the front panel input port as the synchronizing source.

Ext Rear - Allows you to select the external input signal from the rear panel input port as the synchronizing source.

The trigger default settings are listed in the following table:

Trigger Default Settings	
RF Burst: Delay Peak Level Slope	0.000 μ s -6.00 dB Pos
Video (Envlp): Delay Level Slope	0.000 μ s -6.00 dBm Pos
Ext Front: Delay Level Slope	0.000 μ s 2.00 V Pos
Ext Rear: Delay Level Slope	0.000 μ s 2.00 V Pos
Trig Holdoff	0.000 ms
Auto Trig	100.0 ms, On
Frame Timer: Period Offset Sync Source	10.00000 ms 0.000 ms Off

Demod Key Menu

Key Path: **Mode Setup, Demod**

NOTE The **Demod** key allows you to enable or disable HSPDA measurements. This key is unavailable unless Option 210 is installed and licensed.

- **HSDPA/HSUPA Enable** - (Requires Option 210) Enables detection of HSDPA format signals, including QPSK or 16QAM-encoded signals.

Demodulation Default Settings	
HSDPA/HSUPA Enable	On (Requires Option 210)

Input/Output Key Menu

Key path: **Input/Output**

NOTE You can also access this menu from the **Mode Setup, Input** front panel key.

- **Input Port** - Allows you to access the menu to select one of the signal input ports as follows:
 - **RF** - Allows you to measure the RF signal supplied to the **RF INPUT** port.
 - **I/Q** - (For E4406A, requires Option B7C.) Allows you to make measurements on the baseband I/Q signals supplied to the I/Q input ports.
 - **I only** - Allows you to make measurements on a baseband I signal supplied to the front panel I or I input port (VSA Basic mode only).
 - **Q only** - Allows you to make measurements on a baseband Q signal input to the Q or Q input port (VSA Basic mode only).
 - **50 MHz Ref** - (For E4406A) Allows you to measure the 50 MHz reference signal to calibrate the instrument.
 - **Amptd Ref (f=50 MHz)** - (For PSA) Allows you to measure the 50 MHz reference signal to calibrate the instrument.
 - **IF Align** - Allows you to configure the IF alignment signal. The RF path is switched to bring in the same alignment signal that is automatically switched to perform many alignments.
 - **Baseband Align Signal** - (For E4406A) Selects an internal signal used for alignment of Option B7C baseband inputs.
- **Data Source** - Enables sharing of raw data between Code Domain and Modulation Accuracy measurements, as long as critical

measurement parameters are compatible. Data Sharing allows a single measured data set to be used to calculate results of both measurements.

- **Input** - (Default) Signals applied to the RF Input will be measured.
- **Stored** - Press this key to use stored data from either a Code Domain or Modulation Accuracy measurement measurement. (See **Store Capture** below). When the complimentary measurement is then selected, the displayed result will be based on the same raw data as the first measurement, as long as the measurement parameters for Capture Interval, Measurement Control, and Averaging are identical. If the capture length of the stored data is greater than the capture length of the subsequent measurement, the data will be truncated. If the capture length of the stored data is less than the capture length of the subsequent measurement, the capture length will be reset to match the data. See [Table 3-2](#) for more measurement compatibility interactions.
- **Store Capture** - Press this key to store current data in instrument memory for sharing . When this key is pressed, **Data Source** is automatically set to **Stored**.

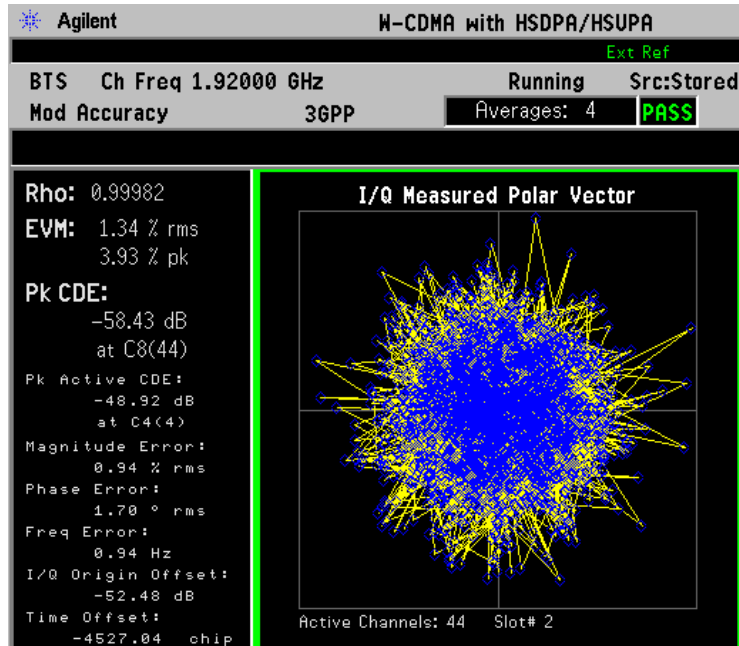
When a measurement is made on a shared data set, the letters “Src:Stored” apper in the upper right hand corner of the display. See [Figure 3-3](#).

Table 3-2 Data Sharing - Measurement Setup Parameter Compatibility

Meas. Parameter	Setting Relationships	Data Sharing Effect
Capture Interval	Meas B = Meas A	Raw data is shared.
	Meas B < Meas A	Meas A data is truncated to fit Meas B setting.
	Meas B > Meas. A	Meas B capture interval, meas offset, and Meas interval settings are overridden- Meas A setting takes effect.

NOTE After completing a shared measurement, you must select **Input, Data Source, Input** to obtain signals at the RF Input for new measurements.

**Figure 3-4 Mod Accuracy Measurement - (BTS) with Data Sharing Enabled
“Src: Stored” Displayed at Top Right Corner**



NOTE

Data can be shared only between Modulation Accuracy and Code Domain measurements. In the table below, “Meas A” refers to the first of a pair of shared data measurements, either Modulation Accuracy or Code Domain. “Meas B” refers to the subsequent complementary measurement performed using the same data set.

- **I/Q Setup** - (For E4406A, Option B7C) Allows you to access the menu to select the input impedance for the baseband I/Q input signals, and to set the dc offset voltages for I/Q input signals. This key is grayed out unless **Input Port** is set to either **I/Q**, **I only**, or **Q only**.
 - **I Offset** - Allows you to set a dc offset voltage value for the I input signal. The range is 0.0000 to 2.5600 V in 0.0001 V.
 - **Q Offset** - Allows you to set a dc offset voltage value for the Q input signal. The range is 0.0000 to 2.5600 V in 0.0001 V.

— **I/Q Input Z** - Allows you to access the menu to select one of the input impedances for baseband I/Q input signals as follows:

50 Ω Unbalanced - Allows you to set the input impedance to unbalanced 50 Ω for use with the I/Q input ports. This is the default setting.

600 Ω Balanced - Allows you to set the input impedance to balanced 600 Ω for use with the I/Q input ports and the I/Q input ports.

1 M Ω Unbalanced - Allows you to set the input impedance to 1 M Ω for use with the I/Q input ports.

1 M Ω Balanced - Allows you to set the input impedance to 1 M Ω for use with the I/Q input ports and the I/Q input ports.

— **I/Q Z Ref** - Allows you to enter a numeric value to set the reference impedance if **I/Q Input Z** is set to 1 M Ω , otherwise this key is grayed out. The range is x.x to y.y MW in z.z MW.

- **RF Input Range** - Allows you to toggle the input range control for the RF signal between **Auto** and **Man** (manual). If **Auto** is chosen, the instrument automatically sets the attenuator, based on the carrier power level where it is tuned.

For example, once you change the **Max Total Pwr** or **Input Atten** value with the RPG knob the **Input Range** key is automatically set to **Man**. If there are multiple carriers present, the total power might overdrive the front end. In this case you need to set the **Input Range** to **Man** and enter the expected maximum total power by activating the **Max Total Pwr** key. **Man** is also useful to hold the input attenuation constant for the best relative power accuracy. For single carriers it is recommended that you set this to **Auto**.

For PSA, when you use the internal preamplifier, Int Preamp, the selections using the **RF Input Range** key are not available, and the key is greyed-out.

For E4406A, Option B7C, if **Input Port** is set to **I/Q** this key is grayed out

Key Reference
Front Panel Keys

- **Max Total Pwr** - Allows you to set the maximum total power level from the UUT (Unit Under Test). The range is -200.00 to 100.00 dBm with 0.01 dB resolution. This is the expected maximum value of the mean carrier power referenced to the output of the UUT; it may include multiple carriers. The **Max Total Pwr** setting is coupled together with the **Input Atten** and **Ext Atten** settings. Once you change the **Max Total Pwr** value with the RPG knob, for example, the **RF Input Range** key is automatically set to **Man**.

For PSA, when you use the internal preamplifier, Int Preamp, the selections using the **Max Total Pwr** key are not available, and the key is greyed-out.

For E4406A, Option B7C, when **Input Port** is set to **I/Q**, this key label changes to **I/Q Range**. It controls the maximum input voltages of the baseband I/Q input signals. The ranges are 130.0 mV, 250.0 mV, 500.0 mV and 1.0 V.

- **Input Atten** - Allows you to control the internal input attenuator setting. The range is 0 to 40 dB with 1 dB resolution. The **Input Atten** key shows the actual hardware value that is used for the current measurement. If more than one input attenuator value is used in a single measurement, the value used at the carrier frequency will be displayed. The **Input Atten** setting is coupled to the **Max Total Pwr** setting. Once you change the **Input Atten** setting with the RPG knob, for example, the **RF Input Range** key is automatically set to **Man**.

For PSA, when you use the internal preamplifier, Int Preamp, the electronic attenuator selections using the **Input Atten** key are not available, and the key is greyed-out. Use the mechanical attenuator under **More 1 of 2, Attenuator**, below.

For E4406A, Option B7C, this attenuator is located in front of the first down converter, therefore it is cannot be used for the baseband I/Q input signals.

- **Ext Atten** - Allows you to access the following menu to enter the external attenuation values. Either of the **Ext Atten** settings is coupled together with the **RF Input Range** setting, however, pressing **Ext Atten** does not switch the **RF Input Range** key to **Man**. This will allow the instrument to display the measurement results referenced to the output of the UUT.
 - **MS** - Allows you to set an external attenuation value for MS tests. The range is -50.00 to $+50.00$ dB with 0.01 dB resolution.
 - **BTS** - Allows you to set an external attenuation value for BTS tests. The range is -50.00 to $+50.00$ dB with 0.01 dB resolution.

- **Int Preamp** - (For PSA, requires Option 1DS) Allows you to control the internal RF input preamplifier. The internal preamplifier provides +30 dB of gain and is useful for lower power measurements. The **Int Preamp** setting default is **Off**. RF power values displayed for these measurements are adjusted to compensate for the internal preamplifier gain, and indicate power levels at the input port. The preamplifier is only available for Modulation Accuracy (EVM and Peak Code Domain Error) measurements, QPSK EVM, and Code Domain measurements. If the **Int Preamp** is not available for a particular measurement, the key is greyed-out.

To avoid damaging the internal preamplifier, limit the total power applied to the RF input to $\leq +25\text{dBm}$.

When using the internal preamplifier, the electronic attenuator selections using the **Input Atten** key are not available, and the key is greyed-out. Use the mechanical attenuator under **More 1 of 2, Attenuator**, below.

- **Attenuator** - (For PSA, requires Option 1DS) When **Int Preamp** is set to **On**, this key allows you to control an internal mechanical input attenuator setting. The settings available are 0 dB, 10 dB, or 20 dB. The **Attenuator** key shows the actual hardware value that is used for the current measurement. The **Attenuator** setting is not coupled to the **Max Total Pwr** setting.

The **Attenuator** is only available for measurements which can use the **Int Preamp**: Modulation Accuracy (EVM and Peak Code Domain Error) measurements, QPSK EVM, and Code Domain measurements. If the **Int Preamp** is not available for a particular measurement, the key is greyed-out.

NOTE

The **Max Total Pwr** and **Input Atten** settings are coupled together, so changing the input **Max Total Pwr** setting by x dB changes the **Input Atten** setting by x dB. When you switch to a different measurement, the **Max Total Pwr** setting is kept constant, but the **Input Atten** may change if the two measurements have different mixer margins. Therefore, you can set the input attenuator manually, or you can set it indirectly by specifying the expected maximum power from the UUT.

Key Reference
Front Panel Keys

Input Default Settings	
Input Port	RF
I/Q Setup ^a (E4406A, Option B7C only)	(disabled)
RF Input Range	Auto ^b
Max Total Pwr	-15.00 dBm ^c
Input Atten	0.00 dB ^c
Ext Atten: MS BTS	0.00 dB 0.00 dB
Int Preamp ^d (PSA only):	OFF

- a. This key is grayed out if **Input Port** is set to **RF**.
- b. Auto is not available for Spectrum measurements.
- c. This may differ if the maximum input power is more than -15.00 dBm, or depending on the previous measurements.
- d. The preamplifier is only available for Modulation Accuracy (EVM and Peak Code Domain Error) measurements, QPSK EVM, and Code Domain measurements.

W-CDMA Measurement Keys

Adjacent Channel Power Ratio (ACPR/ACLR) Keys

NOTE You must have selected ACPR/ACLR at Key Path: **MEASURE** to access these menus.

Measurement Setup Key Menu

Key Path: **Meas Setup**

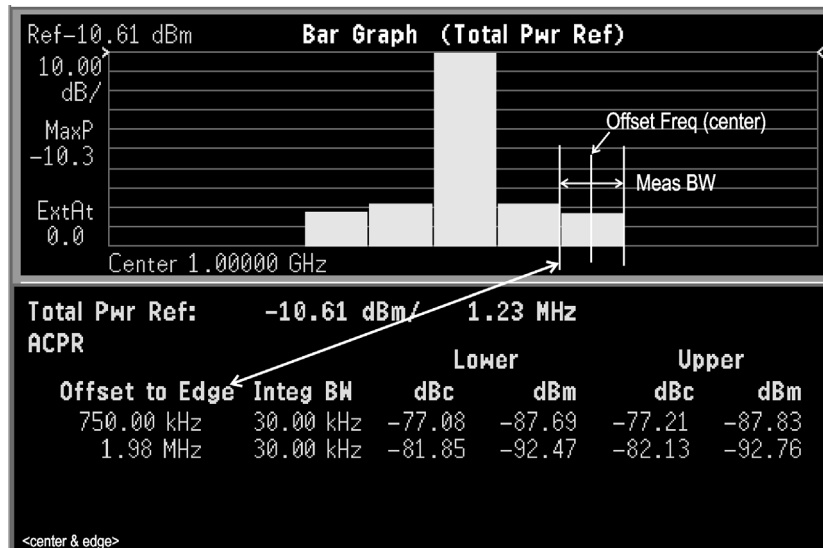
- **Avg Number** - Allows you to change the number of N averages.
- **Avg Mode** - Allows you to toggle the averaging mode between **Exp** (exponential) and **Repeat**. This selection only effects on the averaging result after the number of N averages is reached. The N is set using the **Avg Number** key.
 - **Normal averaging**: Normal (linear) averaging is always used until the specified number of N averages is reached. When the **Measure** key under **Meas Control** is set to **Single**, data acquisition is stopped when the number of N averages is reached, thus **Avg Mode** has no effect in the single measurement mode.
 - **Exponential averaging**: When **Measure** is set to **Cont**, data acquisition will continue indefinitely. Exponential averaging is used with a weighting factor of N (the displayed count of averages stops at N). Exponential averaging weights new data more heavily than old data, which allows tracking of slow-changing signals. The weighting factor N is set using the Avg Number key.
 - **Repeat averaging**: When **Measure** is set to **Cont**, data acquisition will continue indefinitely. After the number of N averages is reached, all previous result data is cleared and the average count displayed is set back to 1. This is equivalent to being in **Measure Single** and pressing the **Restart** key each time the single measurement finishes.
- **Chan Integ BW** - Allows you to specify the channel integration bandwidth in which the channel power levels are measured. The range is 300.0 Hz to 20.0000 MHz with 1 Hz resolution. If **Sweep Type** is set to **Fast**, this key is grayed out.

Key Reference
W-CDMA Measurement Keys

- **Ref Channel** - Allows you to access the following parameters for the reference channel settings:
 - **Chan Integ BW** - Allows you to specify the channel integration bandwidth in which the carrier power is measured. The range is 1.000 kHz to 20.0000 MHz with the best resolution of 1 Hz.
 - **Avg Type** - Allows you to set to power averaging type to either **Pwr Avg (RMS)** or **Maximum**.
 - **Ref Chan Adv** - Allows you to access the menu to change the following advanced parameters for the reference channel:
 - ❑ **Sweep Time** - Allows you to toggle the sweep time function between **Auto** and **Man** (manual), and to set a value for the sweep time ranging from 1.0 ms to 50.000 ms if set to **Man**. If set to **Auto**, the reference channel measurement sweep time is derived from the data points and the number of FFT segments.
 - ❑ **Data Points** - Allows you to toggle the control function of the number of data points between **Auto** and **Man** (manual), and to set the number of data points ranging from 64 to 65536. The automatic mode chooses the optimum number of points ($= 2^{n+6}$ where $n = 0$ to 11) for the fastest measurement time with acceptable repeatability. The minimum number of points that could be used is determined by the sweep time and the sampling rate. You can increase the length of the measured time record (capture more of the burst) by increasing the number of points, but the measurement will take longer.
 - ❑ **Res BW** - This key is always grayed out. However, it allows you to see the resolution bandwidth that is derived from the combination of sweep time, data points, and FFT segments.
 - ❑ **Num FFT Seg** - Allows you to select the number of FFT segments used in making the measurement of the reference channel (carrier). In the automatic mode the measurement optimizes the number of FFT segments required for the shortest measurement time. The minimum number of segments required to make a measurement is set by your desired measurement bandwidth. Selecting more than the minimum number of segments will give you more dynamic range for making the measurement, but the measurement will take longer to execute.
- **Ofs & Limits** - Allows you to access the menu to change the following parameters for offset frequency settings and pass/fail tests:
 - **Offset** - Allows you to access the memory selection menu from **A** to **E** to store 5 sets of values for **Offset Freq**, **Ref BW**, **Abs Limit** and so forth. Only one selection at a time (A, B, C, D, or E) is shown on this key.

- **Offset Freq**- Allows you to enter an offset frequency center value, and to toggle the offset function between **On** and **Off**, according to each offset key selected. The range is 0.0 Hz to 100.000 MHz. While this key is activated, enter an offset frequency center value from the numeric keypad by terminating with one of the frequency unit keys shown. One offset frequency center value corresponding to the **Offset** menu selection is shown on this key., however, this is titled as Offset to Edge in the measurement result window considering the measurement bandwidth.

The following figure illustrates the difference between the offset frequency center and the offset to edge frequency.



- **Ref BW** - Allows you to enter a reference bandwidth ranging from 300.0 Hz to 20.0000 MHz with 1 Hz resolution. When this parameter is changed, the integration bandwidth Integ BW in the summary data window changes to that value.
- **Abs Limit** - Allows you to enter an absolute limit value ranging from -200.00 to +50.00 dBm with 0.01 dB resolution.
- **Fail** - Allows you to access the following menu to select one of the logic keys for fail conditions between the measurement results and the test limits:
 - Absolute** - Fail is shown if one of the absolute ACPR measurement results is larger than the limit for **Abs Limit**.
 - Relative** - Fail is shown if one of the relative ACPR measurement results is larger than the limit for **Rel Lim (Car)** or **Rel Lim (PSD)**.
 - Abs AND Rel** - Fail is shown if one of the absolute ACPR measurement results is larger than the limit for **Abs Limit** AND one of the relative ACPR measurement results is larger than the limit for **Rel Lim (Car)** or **Rel Lim (PSD)**.

Key Reference
W-CDMA Measurement Keys

❑ **Abs OR Rel - Fail** is shown if one of the absolute ACPR measurement results is larger than the limit for **Abs Limit OR** one of the relative ACPR measurement results is larger than the limit for **Rel Lim (Car)** or **Rel Lim (PSD)**.

— **Rel Lim (Car)** - Allows you to enter a relative limit value of the carrier level ranging from -200.00 to +50.00 dBc with 0.01 dB resolution.

— **Rel Lim (PSD)** - Allows you to enter a relative limit value of the power spectral density level ranging from -200.00 to +50.00 dB with 0.01 dB resolution.

Table 3-3 Default Offsets and Limits

Offset	Offset Freq (MHz)	Abs Limit (dBm)	Rel Limit (Car) (dBc)		Rel Limit (PSD) (dB)	
			BTS	MS	BTS	MS
A, On	5.000	50.00	-44.20	-32.20	-44.20	-32.20
B, On	10.000	50.00	-49.20	-42.20	-49.20	-42.20
C, Off	15.000	50.00	-49.20	-42.20	-49.20	-42.20
D, Off	20.000	50.00	-49.20	-42.20	-49.20	-42.20
E, Off	25.000	50.00	-49.20	-42.20	-49.20	-42.20

Table 3-4 Default Offsets and Limits

Offset	Offset Frequency (kHz)		Abs Limit (dBm)	Rel Limit (Car) (dBc)	Rel Limit (PSD) (dB)
	BTS	MS		BTS/MS	BTS/MS
A, On	765.0	900.0	50.00	0.00	0.00
B, On	1995.0	1995.0	50.00	0.00	0.00
C, Off	0.000	0.000	50.00	0.00	0.00
D, Off	0.000	0.000	50.00	0.00	0.00
E, Off	0.000	0.000	50.00	0.00	0.00

- **Offset/Limits** - Allows you to access the menu to change the following parameters for offset frequency settings and pass/fail tests:
 - **Offset** - Allows you to select one of five offsets (**A** through **E**). Only one selection at a time (**A**, **B**, **C**, **D**, or **E**) is shown on this key label. The remaining softkeys on the **Offset/Limits** menu then apply to the selected offset.
 - **Offset Freq** - Allows you to enter an offset frequency value and toggle the offset function between **On** and **Off**. The range is 0.0 Hz to 45.000 MHz. While this key is activated, enter an offset value from the numeric keypad by terminating with one of the frequency unit keys shown. Offsets **A** and **B** are defaulted as follows for BS tests, while others are defaulted to 0.0 Hz and **Off**:
 - Offset A: 750.00 kHz, **On**
 - Offset B: 1.9800 MHz, **On**One offset frequency center value corresponding to the **Offset** menu selection is shown on this key label.
 - **Offset Side** - Choose **Neg** (negative) or **Pos** (positive) to have single-sided offsets relative to the carrier, or **Both** (the default) to have offset frequency pairs.
 - **Ref BW** - Allows you to enter a reference bandwidth ranging from 300 Hz to 20.0000 MHz with the best resolution of 1 Hz. When this parameter is changed, the integration bandwidth **Integ BW** in the summary data window changes to that value.
 - **Avg Type** - Choose the type of averaging between **Pwr Avg (RMS)** or **Maximum**.
 - **Limit Setup** - Allows you to access the menu to setup the limit values and conditions.
 - Abs Limit** - Allows you to enter an absolute limit value ranging from -200.00 to +50.00 dBm with 0.01 dB resolution.
 - Fail** - Allows you to access the following menu to select one of the logic keys for fail conditions between the measurement results and the test limits:
 - AND** - Fail is shown if one of the relative ACP measurement results is larger than **Rel Lim (Car)** or **Rel Lim (PSD)** AND one of the absolute ACP measurement results is larger than **Abs Limit**.
 - OR** - Fail is shown if one of the relative ACP measurement results is larger than **Rel Lim (Car)** or **Rel Lim (PSD)** OR one of the absolute ACP measurement results is larger than **Abs Limit**.

Absolute - Fail is shown if one of the absolute ACP measurement results is larger than **Abs Limit**.

Relative - Fail is shown if one of the relative ACP measurement results is larger than **Rel Lim (Car)** or **Rel (PSD)**.

- ❑ **Rel Lim (Car)**- Allows you to enter a relative limit value of the carrier level ranging from -150.00 to $+50.00$ dBc with 0.01 dB resolution. The default is -45.00 dBc for **Offset A** and -60.00 dBc for **Offset B**.
- ❑ **Rel Lim (PSD)**- Allows you to enter a relative limit value of the power spectral density level ranging from -150.00 to $+50.00$ dB with 0.01 dB resolution. The default is -28.87 dB for **Offset A** and -43.87 dB for **Offset B**.
- **Offset Adv** - Allows you to access the menu to change the following advanced offset parameters:
 - ❑ **Sweep Time** - Allows you to toggle the sweep time function between **Auto** and **Man** (manual), and to set a value for the sweep time ranging from 1.0 ms to 50.000 ms if set to **Man**. If set to **Auto**, the offset channel measurement sweep time is derived from the data points and the number of FFT segments.
 - ❑ **Data Points** - Allows you to toggle the control function of the number of data points between **Auto** and **Man** (manual), and to set the number of data points ranging from 64 to 65536. If set to **Auto**, the optimum number of points ($= 2^{n+6}$ where $n = 0$ to 11) for the fastest measurement time with acceptable repeatability is automatically determined. The minimum number of points that could be used is determined by the sweep time and the sampling rate. You can increase the length of the measured time record (capture more of the burst) by increasing the number of points, but the measurement will take longer.
 - ❑ **Res BW** - This key is always grayed out. However, it allows you to see the resolution bandwidth that is derived from the combination of sweep time, data points, and FFT segments.
 - ❑ **Num FFT Seg** - The automatic mode selects the optimum number of FFT segments to measure the offset, while making the fastest possible measurement.

- **Relative Atten** - Allows you to set a relative amount of attenuation for the measurements made at your offsets. The amount of attenuation is always specified relative to the attenuation that is required to measure the carrier channel. Since the offset channel power is lower than the carrier channel power, less attenuation is required to measure the offset channel and you get wider dynamic range for the measurement.
- **Meas Type** - Allows you to access the menu to select one of the measurement reference types.
 - **Total Pwr Ref** - Select this to set the total carrier power to the measurement reference level and the measured data is shown in dBc and dBm.
 - **PSD Ref** - Select this to set the mean power spectral density of the carrier to the measurement reference level and the measured data is shown in dB and dBm/Hz.
- **Fast ACP** - Allows you to increase the speed of the measurement. A time domain computation method is used rather than an FFT transformation. When this faster measurement method is selected, repeatability is slightly reduced.
- **Spectrum Trace** - Turns off the spectrum trace data calculations. This is only applicable when using the Spectrum View. It speeds up the display of the other measured data values by not calculating the spectrum trace.
- **Limit Test** - Turns on or off the limit test function.
- **Sweep Type** - Allows you to select the method of measurement between **FFT** and **Swp** (swept), **Swp** (swept), or **Fast**.

If set to **FFT**, the signal is digitized in a series of moderate bandwidth measurements. The LO (local oscillator) changes frequency to center the analysis region for each step in this series. A Fast Fourier Transform is used to convert the digitized signal to a spectrum at each step. The steps are combined to create a spectrum. The power in each offset is computed from that spectrum. The **FFT Sweep Type** provides maximum dynamic range and accuracy.

If set to swept (**Swp**), the LO is stepped in small steps to simulate swept spectrum analysis. Swept spectrum analysis can provide a spectrum display with peak detection that is more familiar to many users. But swept analysis is slower and no more accurate than **FFT** analysis. Only **Spectrum** view is available in swept analysis.

If set to **Fast**, the signal is digitized in the smallest possible number of measurements with the LO hopping in frequency between the centers of the analysis regions of these measurements. A Fast Fourier Transform is used to convert the digitized signal to a spectrum. The power in each offset is computed from that spectrum. The Fast Sweep Type provides maximum speed, but with reduced dynamic range and reduced accuracy. Only **Bar Graph** view is available in **Fast** analysis.

- **Swp RBW** - Allows you to control the resolution bandwidth to be used when the Sweep Type is swept. If set to **Auto**, the RBW is automatically selected based on the sweep span, which is determined by the **Offset Freq** and **Ref BW**. If set to **Man**, the RBW is set manually. The allowed range is 1.000 kHz to 1.000000 MHz with 1 Hz resolution.
- **Swp Det** - Allows you to select **Avg** (average) or **Peak** detection to be used when the Sweep Type is swept. Both detectors operate during the data acquisition time for each measurement point of the sweep. Average detection measures the average power during that time, as required for accurate adjacent channel power measurements. Peak detection measures the peak power during the data acquisition time.
- **Restore Meas Defaults** - Allows you to preset only the settings that are specific to the selected measurement by pressing **Meas Setup, More (1 of 2), Restore Meas Defaults**. This will set the measure setup parameters, for the currently selected measurement only, to the factory defaults.
- **Advanced** - Allows you to access the menu to set the following parameters:
 - **Swp Acq Time** - Allows you to set the data acquisition time when **Sweep Type** is set to **Swp**. The range is 500 μ s to 10.000 ms with 1 μ s resolution.
 - **RRC Filter** - Allows you to toggle the root-raised cosine filter function between **On** and **Off**. This is grayed out if **Sweep Type** is set to **Fast**.
 - **Filter Alpha** - Allows you to change the alpha value of the RRC filter. The range is 0.010 to 0.500 with 0.001 resolution. This is grayed out if **Sweep Type** is set to **Fast**.

— **Offset Ch Range (FAST Mode)** - Allows you to optimize the ADC input range aligned with the input signal by changing **ADC Range** and **Relative Atten** (attenuation) if **Sweep Type** is set to **Fast**.

- ❑ **ADC Range** - Allows you to access the following selection menu to define one of the ADC ranging functions:

Auto - Select this to set the ADC range automatically. For most FFT measurements, the auto feature should not be selected. An exception is when measuring a signal which is “bursty”, in which case **Auto** can maximize the time domain dynamic range, if FFT results are less important to you than time domain results.

Auto Peak - Select this to set the ADC range automatically to the peak signal level. **Auto Peak** is a compromise that works well for both CW and burst signals.

Auto Peak Lock - Select this to hold the ADC range automatically at the peak signal level. **Auto Peak Lock** is more stable than **Auto Peak** for CW signals, but should not be used for “bursty” signals.

Manual - Allows you to access the selection menu of values, -6 to +24 dB for E4406A or None to +18 dB for PSA, to set the ADC range level. To optimize the ADC range, set the **Manual** range value and the **Relative Atten** value so that the error message “Input overload” is not displayed. Also, note that manual ranging is best for a CW signal.

- ❑ **Relative Atten** - Allows you to enter a relative amount of attenuation for the measurements at the offset channels in the fast mode. The range is -40.00 to 40.00 dB with 0.01 dB resolution. The value of this function is set in conjunction with the **Manual** range value. This attenuation is always specified relative to the attenuation that is required to measure the carrier channel. Since the offset channel power is lower than the carrier channel power, less attenuation is required to measure the offset channels and wider dynamic range is available for the measurement.

The next table shows the factory default settings for adjacent channel power ratio measurements.

Table 3-5 Adjacent Channel Power Ratio Measurement Defaults

Measurement Parameter	Factory Default Condition
View/Trace	Bar Graph (Total Pwr Ref)
Spectrum Trace	On
Avg Number	2010; On
Avg Mode	Repeat
Avg Mode	Exp
Ref Channel:	
Chan Integ BW	1.23000 MHz
Avg Type	Pwr Avg (RMS)
Ref Chan Adv.:	
Sweep Time	546.1 μ s; Auto
Data Points	2048; Auto
Res BW	1.620 kHz (grayed out)
Num FFT Seg	1; Auto
Offset/Limits:	
Offset	A
Offset Freq	A: 750.000 kHz; On B: 1.98000 MHz; On
Offset Side	Both
Ref BW	30.000 kHz
Avg Type	Pwr Avg (RMS)
Limit Setup:	
Abs Limit	0.00 dBm
Fail	Relative
Rel Lim (Car)	A: -45.00 dBc B: -60.00 dBc
Rel Lim (PSD)	A: -28.87 dB B: -43.87 dB
Offset Adv.:	
Sweep Time	11.20 ms; Auto
Data Points	1024; Auto
Res BW	79.0 Hz (grayed out)
Num FFT Seg	1; Auto
Relative Atten	0.00 dB
Chan Integ BW	3.84000 MHz 1.23000 MHz

Table 3-5 Adjacent Channel Power Ratio Measurement Defaults

Measurement Parameter	Factory Default Condition
Ofs & Limits: Offset Offset Freq	A A: 5.00000 MHz; 765.000 kHz; On B: 10.0000 MHz; 1.99500 MHz; On C: 15.0000 MHz; 0.0 Hz; Off D: 20.0000 MHz; 0.0 Hz; Off E: 25.0000 MHz; 0.0 Hz; Off
Ref BW	A to E: 30.000 kHz; 3.84000 MHz
Abs Limit	A to E: 50.00 dBm
Fail	A to E: Relative
Rel Lim (Car)	A to E: 0.00 dBc; A: -44.20 dBc, B to E: -49.20 dBc
Rel Lim (PSD)	A to E: 0.00 dBA; A: -44.20 dB, B to E: -49.20 dB
Meas Type	Total Pwr Ref
Trig Source	Free Run (Immediate)
Fast ACP	Off
Trigger Source	RF burst (inbound)
Limit Test	On
Reference BW	18 kHz
Offset frequency	25.000 kHz
Offset bandwidth	10.000 kHz
Absolute limit	0.00 dBm
Fail	Relative
Relative limit (carrier)	-60 dB
Relative limit (PSD)	-57.45 dB
Sweep Type	FFT
Swp RBW (grayed out for FFT/Fast)	41.6676.667 kHz; Auto
Swp Det (grayed out for FFT/Fast)	PeakAvg
Advanced	
Swp Acq Time	1.250 ms (grayed out for FFT)
Swp Acq Time	625.0 μs (grayed out for FFT/Fast)
RRC Filter	On (grayed out for Fast)
Filter Alpha	0.220 (grayed out for Fast)

Table 3-5

Adjacent Channel Power Ratio Measurement Defaults

Measurement Parameter	Factory Default Condition
Offset Ch Range (Fast Mode): ADC Range Relative Atten	(grayed out for FFT/Swp) Auto Peak 0.00 dB

View/Trace Key MenuKey Path: **View/Trace**

The **View/Trace** key accesses the menu to select either **Bar Graph** or **Spectrum** for the measurement result, depending on the **Sweep Type** setting.

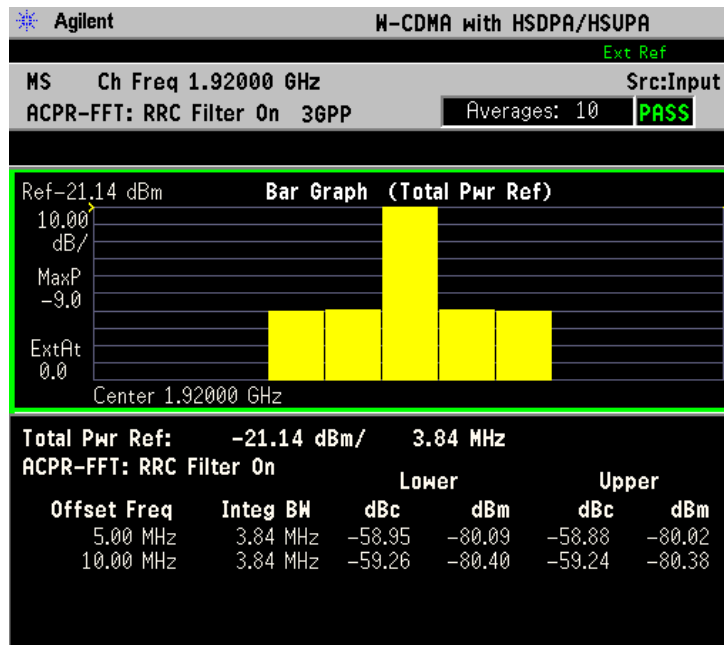
- **Bar Graph** - In the factory default condition 5 of the total integration power levels, centered at the carrier frequency and $\pm 765.0 \text{ kHz} \pm 5.0 \text{ MHz}$ and $\pm 1.995 \text{ MHz} \pm 10.0 \text{ MHz}$ offset frequencies, are shown in the figure for the “Results” section. The corresponding measured data is shown in the text window. Depending on the **Meas Type** selection, one of the two following displays is obtained:

Bar Graph (Total Pwr Ref) - A histogram of powers referenced to the total power

Bar Graph (PSD Ref) - A histogram of powers referenced to the mean power spectral density of the carrier in dBm/Hz

If **Sweep Type** is set **Fast**, the figure changes as follows and only **Bar Graph** is available for **View/Trace**.as shown in [Figure 3-5](#)

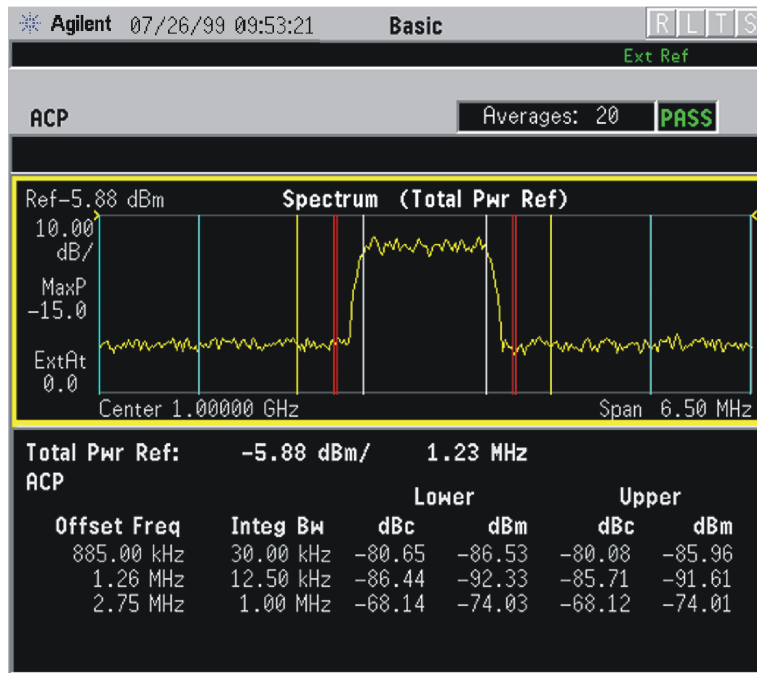
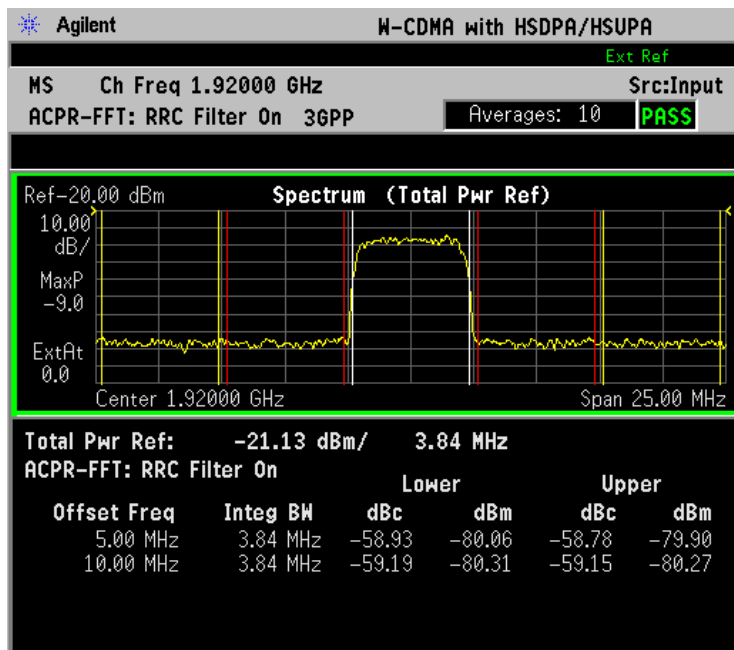
Figure 3-5 ACPR Measurement - Fast Bar Graph (Total Pwr Ref) View



*Meas Setup: Sweep Type = Fast,
Other factory default settings

*Input signal: -20.00 dBm, Test Model 1 (16 DPCH)

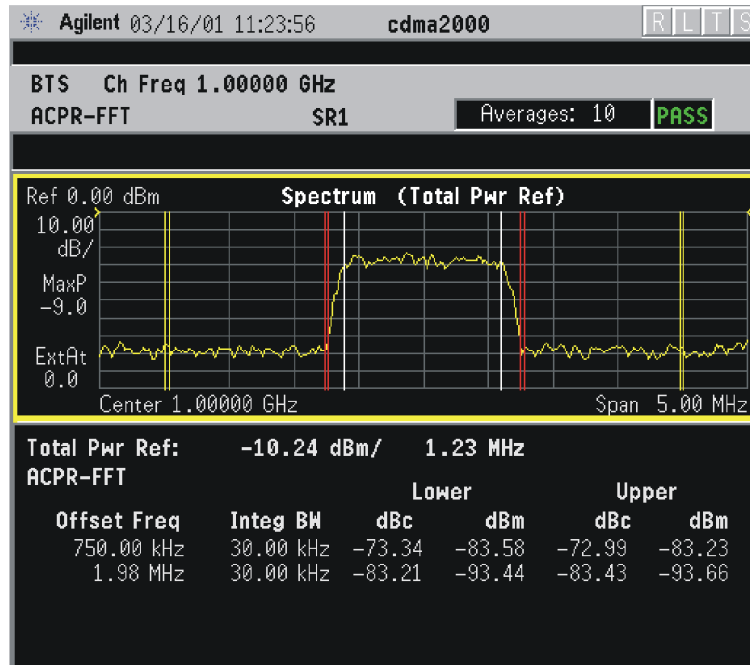
- **Spectrum** - In the factory default condition, the frequency spectrum with the FFT sweep type is displayed with the bandwidth marker lines in the graph window. The corresponding measured data in the text window is the total integration power levels, in dBc and dBm, within the defined bandwidth as shown in the figure below.

Figure 3-6 ACP Measurement - Spectrum View**Figure 3-7 ACPR Measurement - FFT Spectrum (Total Pwr Ref) View**

*Meas Setup: View/Trace = Spectrum,
Others = Factory default settings

*Input signal: **Figure 3-8** -20.00 dBm, Test Model 1 (16 DPCH)

Figure 3-9 ACPR Measurement - FFT Spectrum (Total Pwr Ref) View



*Meas Setup: View/Trace = Spectrum,
Others = Factory default settings

*Input signal: -10.00 dBm, 9 channels of SR1, cdma2000 Rev 8

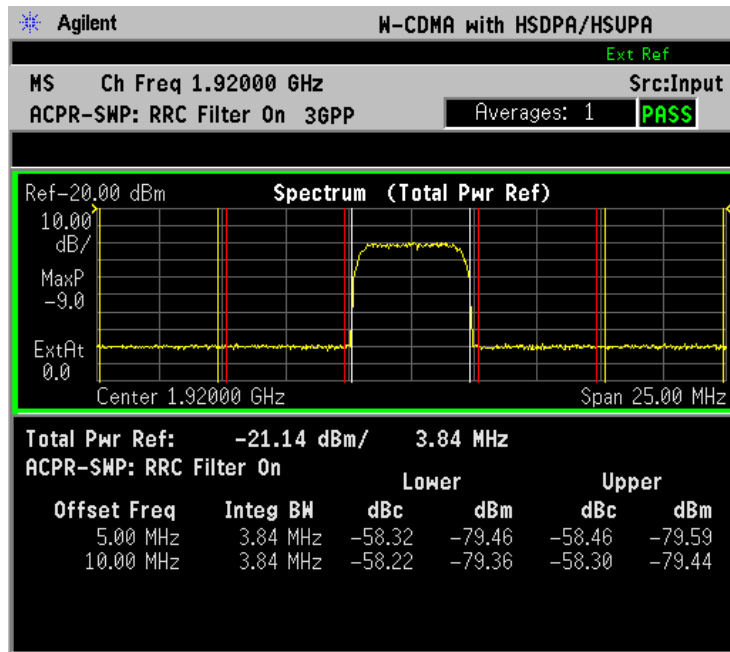
Depending on the **Meas Type** setting, one of the two following displays is obtained:

Spectrum (Total Pwr Ref) - A spectrum display referenced to the total power

Spectrum (PSD Ref) - A spectrum display referenced to the mean power spectral density of the carrier in dBm/Hz

You can improve the update speed of the displayed data values by turning off the spectrum trace in **Meas Setup**.

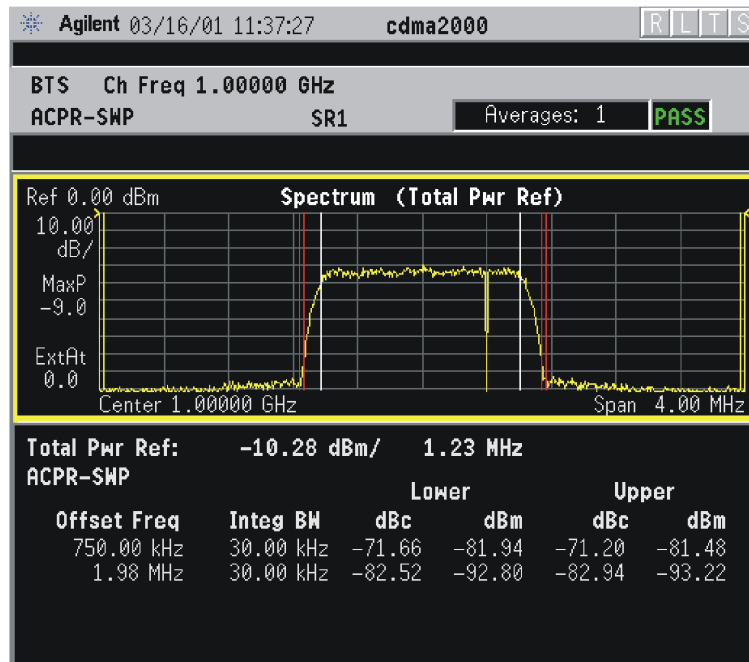
If **Sweep Type** is set to **Swp**, the swept frequency ACPR is displayed as shown below and only **Spectrum** is available for **View/Trace**.

Figure 3-10 ACPR Measurement - Swept Spectrum (Total Pwr Ref) View

*Meas Setup: View/Trace = Spectrum,
Sweep Type = Swp,
Others = Factory default settings

*Input signal: -20.00 dBm, Test Model 1 (16 DPCH)

Figure 3-11 ACPR Measurement - Swept Spectrum (Total Pwr Ref) View



*Meas Setup: View/Trace = Spectrum,
Sweep Type = Swp,
Others = Factory default settings

*Input signal: -10.00 dBm, 9 channels of SR1, cdma2000 Rev 8

NOTE

If **Sweep Type** is set to **FFT**, the spectrum graph does not show the actual power level measured at each of the offsets. Select **Swp** for the more accurate spectrum graph.

While in this view, you can change the vertical scale by pressing the **AMPLITUDE Y Scale** key. You can also activate or deactivate the reference bandwidth markers by pressing the **Display** key.

AMPLITUDE Y Scale Key Menu

Key Path: **AMPLITUDE Y Scale**

NOTE

View/Trace must be set to **Spectrum** to access following the **AMPLITUDE Y Scale** keys

- **Scale/Div** - Allows you to enter a numeric value to change the vertical display sensitivity. The range is 0.10 to 20.00 dB with 0.01 dB resolution. The default setting is 10.00 dB. However, since the **Scale Coupling** is defaulted to **On**, this value is automatically determined by the measurement result. When you set a value manually, **Scale Coupling** automatically changes to **Off**.
- **Ref Value** - Allows you to set the absolute power reference value ranging from -250.00 to 250.00 dBm with 0.01 dB resolution. The default setting is 10.00 dBm. However, since the **Scale Coupling** is defaulted to **On**, this value is automatically determined by the measurement result. When you set a value manually, **Scale Coupling** automatically changes to **Off**.
- **Ref Position** - Allows you to set the reference position to either **Top**, **Ctr** (center), or **Bot** (bottom). The default setting is **Top**.
- **Scale Coupling** - Allows you to toggle the scale coupling function between **On** and **Off**. The default setting is **On**. Upon pressing the **Restart** front-panel key or **Restart** softkey under the **Meas Control** menu, this function automatically determines the scale per division and reference values based on the measurement results. When you set a value to either **Scale/Div** or **Ref Value** manually, **Scale Coupling** automatically changes to **Off**.

Display Key Menu

Key Path: **Display**

NOTE

View/Trace must be set to **Spectrum**, to access the following **Display** key.

- **Ref BW Marker** - Allows you to toggle the reference bandwidth markers function between **On** and **Off**. If set to **On**, the vertical line markers with the reference bandwidth are shown on the measurement result display.

Marker Key Menu

The **Marker** key is not available for this measurement function.

Channel Power Keys

NOTE

You must have selected Channel Power at Key Path: **MEASURE** to use these menus.

Measurement Setup Key Menu

Key Path: **Meas Setup**

- **Avg Number** - Allows you to change the number of N averages.
- **Avg Mode** - Allows you to toggle the averaging mode between **Exp** (exponential) and **Repeat**. This selection only effects on the averaging result after the number of N averages is reached. The N is set using the **Avg Number** key.
 - **Normal averaging**: Normal (linear) averaging is always used until the specified number of N averages is reached. When the **Measure** key under **Meas Control** is set to **Single**, data acquisition is stopped when the number of N averages is reached, thus **Avg Mode** has no effect in the single measurement mode.
 - **Exponential averaging**: When **Measure** is set to **Cont**, data acquisition will continue indefinitely. Exponential averaging is used with a weighting factor of N (the displayed count of averages stops at N). Exponential averaging weights new data more heavily than old data, which allows tracking of slow-changing signals. The weighting factor N is set using the Avg Number key.
 - **Repeat averaging**: When **Measure** is set to **Cont**, data acquisition will continue indefinitely. After the number of N averages is reached, all previous result data is cleared and the average count displayed is set back to 1. This is equivalent to being in **Measure Single** and pressing the **Restart** key each time the single measurement finishes.
- **Integ BW** - Allows you to specify the integration bandwidth in which the power is measured. The range is 1.000 kHz to 10.0000 MHz with 1 Hz resolution. Since **Integ BW** is coupled to **Chan Power Span** in the factory default condition, if you change the integration bandwidth setting, the channel power span setting changes by a proportional amount, 1.2 times the integration bandwidth, until a limit value is reached.

Key Reference
W-CDMA Measurement Keys

- **Chan Power Span** - Allows you to set the frequency span for the channel power measurement. The range is 1.000 kHz to 10.0000 MHz with 1 Hz resolution. This span is used for the current integration bandwidth setting. Since **Chan Power Span** is coupled to **Integ BW** in the factory default condition, if you change the integration bandwidth setting, the channel power span setting changes by a proportional amount, 1.2 times the integration bandwidth, until a limit value is reached. However, the channel power span can be individually set.
- **Restore Meas Defaults** - Allows you to preset only the settings that are specific to the selected measurement by pressing **Meas Setup, More (1 of 2), Restore Meas Defaults**. This will set the measure setup parameters, for the currently selected measurement only, to the factory defaults.
- **Advanced** - Allows you to access the following menu to modify the channel power measurement parameters:

NOTE

Parameters under the **Advanced** key seldom need to be changed. Any changes from the factory default values may result in invalid measurement data.

- **Sweep Time** - Allows you to manually change the sweep time and also to toggle the sweep time control between **Auto** and **Man** (manual). The range is 1.0 μ s to 50.00 ms with 1 μ s resolution. If set to **Auto**, the sweep time derived from the data point setting is shown on this key regardless of the manual entry range.
- **Data Points** - Allows you to select the number of data points and also to toggle the data point control between **Auto** and **Man** (manual). The range is 64 to 65536 with the acceptable entry in powers of 2 (for example: 64, 128, 512). If set to **Auto**, the optimum number of points is determined for the fastest measurement time with acceptable repeatability. The minimum number of points that could be used is determined by the sweep time and the sampling rate. You can increase the length of the measured time record (capture more of the burst) by increasing the number of points, but the measurement will take longer.
- **Res BW** - Shows information on the resolution bandwidth derived from the sweep time. This key is always grayed out.
- **Trig Source** - Allows you to choose a trigger source from **Free Run (Immediate)**, **Video (Envlp)**, **RF Burst (Wideband)**, **Ext Front**, **Ext Rear**, **Frame**, **I/Q Input**, or **Line**.
- **Trig Source** - Allows you to choose a trigger source from **Free Run (Immediate)**, **Video (Envlp)**, **RF Burst**, **Ext Front**, **Ext Rear**, **Frame**, or **Line**.

The next table shows the factory default settings for channel power measurements.

Table 3-6 Channel Power Measurement Defaults

Measurement Parameter	Factory Default Condition
Meas Setup:	
Avg Number	200; On
Avg Mode	Repeat
Integ BW ^a	5.00000 MHz
Chan Power Span ^a	6.00000 MHz
Advanced	
Sweep Time	17.0 μ s 68.27 μ s 68.0 μ s; Auto
Data Points	2048; Auto
Res BW (grayed out)	111.429 kHz 27.857 kHz 30,000 kHz (grayed out)
Trig Source	Free Run (Immediate)

a. The Integ BW setting proportionally changes the Chan Power Span setting up to 10 MHz.

AMPLITUDE Y Scale Key Menu

Key Path: **AMPLITUDE Y Scale**

The **AMPLITUDE Y Scale** key accesses the menu to set the desired vertical scale and associated settings:

- **Scale/Div** - Allows you to enter a numeric value to change the vertical display sensitivity. The range is 0.10 to 20.00 dB with 0.01 dB resolution. The default setting is 10.00 dB. However, since the **Scale Coupling** default is **On**, this value is automatically determined by the measurement result. When you set a value manually, **Scale Coupling** automatically changes to **Off**.
- **Ref Value** - Allows you to set the absolute power reference value ranging from -250.00 to 250.00 dBm with 0.01 dB resolution. The default setting is 10.00 dBm. However, since the **Scale Coupling** default is **On**, this value is automatically determined by the measurement result. When you set a value manually, **Scale Coupling** automatically changes to **Off**.
- **Ref Position** - Allows you to set the display reference position to either **Top**, **Ctr** (center), or **Bot** (bottom). The default setting is **Top**.
- **Scale Coupling** - Allows you to toggle the scale coupling function between **On** and **Off**. The default setting is **On**. Upon pressing the **Restart** front-panel key or **Restart** softkey under the **Meas Control** menu, the scale coupling function automatically determines the scale per division and reference values based on the measurement results. When you set a value to either **Scale/Div** or **Ref Value** manually, **Scale Coupling** automatically changes to **Off**.

Marker Key Menu

The **Marker** key is not available for this measurement function.

Code Domain Keys

NOTE

You must have selected Code Domain under the **MEASURE** key to access the following menus.

Meas Setup Key Menu

Key Path: **Code Domain, Meas Setup**

- **Meas Type** - Allows you to toggle the code domain power measurement type between **Abs** (absolute) and **Rel** (relative). If set to **Abs**, the measurement is made in the absolute power in dBm. If set to **Rel**, the measurement is made in the relative power in dBc.
- **Symbol Rate** - Allows you to set the symbol rate ranging from 7.5 to 960 ksps. The parameter automatically sets the maximum value for **Code Number** when appropriate. Note that 1920 ksps is the maximum symbol rate for uplink.
- **Code Number** - Allows you to set the code number. The range is 0 to 511 depending on the **Symbol Rate** setting as follows:

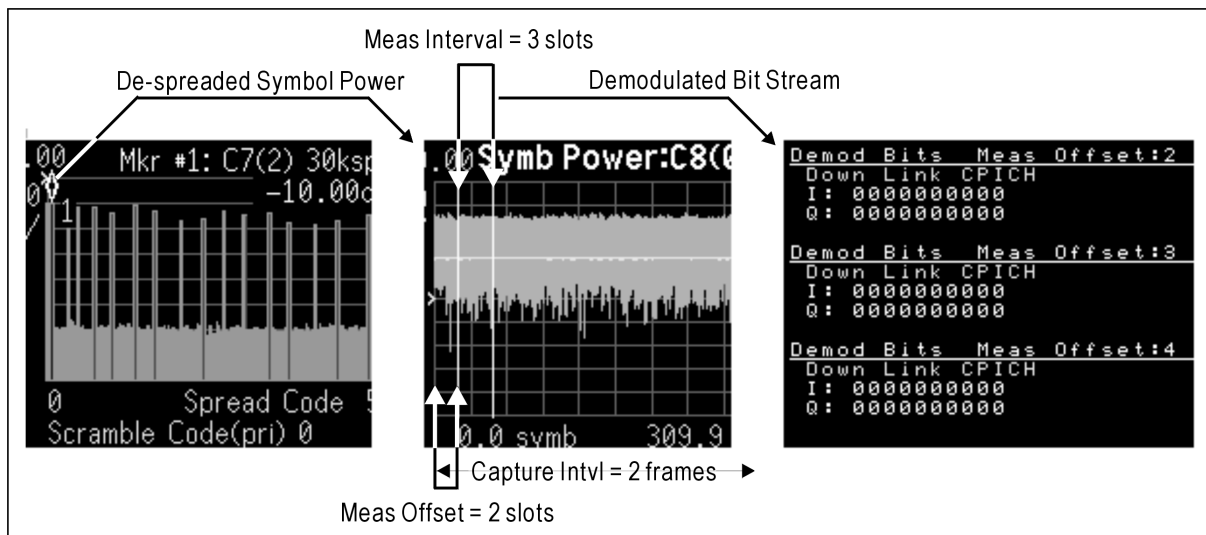
Symbol Rate	Code Number	Description
7.5 ksps	0 to 511	Not available if Device is MS.
15 ksps	0 to 255	
30 ksps	0 to 127	
:	:	
480 ksps	0 to 7	
960 ksps	0 to 3	Not available if Device is BTS.
1920 ksps	0 to 1	

- **I/Q Branch** - Allows you to toggle the selection of the branch signals between **I**, **Q**, and **IQC** (I/Q Combined) The default selection is **Q**. This key is available if **Device** is set to **MS**.

Key Reference
W-CDMA Measurement Keys

- **Mod Scheme** - This key is available when **Mode Setup, Device** is set to **BTS** and **Symbol Rate** is set to 240 ksps only. Select a Modulation Scheme from the following menu:
 - **Auto** - Select **Auto** to allow the instrument to determine the modulation method for the BTS signal.
 - **QPSK** - Select when modulation scheme is QPSK.
 - **16QAM** - Select when modulation scheme is 16QAM.
- **Meas Interval** - Allows you to set the number of slots over which the selected code channel analyses are made. Note that code domain power measurement is done with one slot specified by **Meas Offset**. The default range is 1 to 15 slots (1 frame) in conjunction with the **Meas Offset** value. The maximum value is 15 minus the **Meas Offset** value. The marker lines of which width proportionally varies with this number of slots are displayed in the symbol power graphs of the **Code Domain (Quad View)** and **Demod Bits** displays. Refer to [Figure 3-12](#), which illustrates the relationships between the capture interval and measurement offset parameters.

Figure 3-12 Capture Interval and Measurement Offset Parameters



- **Meas Offset** - Allows you to set the number of offset slots to make the symbol power measurement. The default range is 0 to 14 slots (15 slots/frame \times 1 frame **Capture Intvl**, less 1 slot) in conjunction with the **Meas Interval** value. The maximum value is 15 minus the **Meas Interval** value. The marker lines shift to the right by this number of slots in the symbol power graphs of the **Code Domain (Quad View)** and **Demod Bits** displays. Refer to the illustration for the relationships between the capture interval and measurement offset parameters.

- **Sync Type** - Allows you to access the selection menu to set a channel to be synchronized with. When **Device** is set to **BTS**:
 - **CPICH** - CPICH channel is searched for synchronization.
 - **SCH** - SCH channel is searched for synchronization.
 - **Symbol Based** - Allows you to access the menu for the code symbol to synchronize with. If **Demod Bits** under **View/Trace** is selected, the **Symbol Based** menu is unavailable, and the key is greyed-out.
 - Symbol Rate** - Allows you to set the symbol rate ranging from 7.5 to 960 ksp/s. The parameter automatically sets the maximum value for **Code Number** when appropriate.
 - Code Number** - Allows you to set the code number. The range is 0 to 511 depending on the **Symbol Rate** setting.
 - **Antenna-2 CPICH** - CPICH from STTD antenna-2 is searched for synchronization.
 - **Antenna-1 TSTD SCH** - SCH from TSTD antenna-1 is searched for synchronization.
 - **Antenna-2 TSTD SCH** - SCH from TSTD antenna-2 is searched for synchronization.

When **Device** is set to **MS**, the following **Sync Type** selections are available:

- **DPCCH** - DPCCH channel is searched for synchronization.
- **PRACH Message** - PRACH message control portion is searched for synchronization.

NOTE

To measure PRACH messages of 10 ms or 20 ms length, set **Capture Intvl** to 1 frame or 2 frames, respectively.

- **Slot Format** - Defines the DPCCH pilot pattern to synchronize with, and allows you to enter an integer from SF0 to SF5, or to select **Auto**. This key is available when **DPCCH** is selected under **Sync Type**.
- **Preamble Sig** - Allows you to set a signature pattern from 0 to 15 or to select **AUTO** to perform an automatic search. This key is available when **Sync Type** is set to **PRACH Message**.
- **P-Scramble Code** - Allows you to enter a numeric value for the primary scramble code. The range is 0 to 511. This key is available when **Device** is set to **BTS**.
- **Scramble Code Offset** - Allows you to set the number of scramble code offsets (for selecting a secondary scramble code) to make the code domain power measurement. The range is 0 to 15. This key is available if **Device** is set to **BTS**.

- **Scramble Code** - Allows you to enter a hexadecimal value for the scramble code. The range is 0 to 0×FFFFFF. Pressing this key reveals the keys labeled **A** to **F** and **Done**. Use these keys and the numeric keypad to enter a hexadecimal value by terminating with the **Done** key. This key is available if **Device** is set to **MS**.
- **Scramble Code Type** - Allows you to set the scramble code type to either **Std** (standard), **Left**, or **Right** to make the code domain power measurement. This key is available if **Device** is set to **BTS**.
- **Symbol Boundary** - Allows you to access the following menu to choose a symbol boundary detection mode, which specifies how active channels are detected.
 - **Auto** - Various code channels are examined and appropriate code channels are detected as active channels. The **Auto** measurement algorithm makes the assumption that active channels may vary slot-by-slot over the entire capture interval. Even if channels are being transmitted as bursts, good results will be obtained using the **AUTO** setting.
 - **Predefined Test Models** - Allows you to access selection menus for the test models by number, then allow further selection of various combinations of channels to be detected as active. Channels specified by a Test Model number are always detected as active regardless of the power level or modulation quality. This key is available if **Device** is set to **BTS**.
 - **Test Model 1** - Press this key to access a menu to allow further selections of Test Model 1 with 16, 32 or 64 DPCH channels, and to select a Test Model with or without S-CCPCH.
 - Test Model 1 w/16 DPCH w/ S-CCPCH - Select this to set the active channel detection to the Test Model 1 with 16 DPCH channels and 1 S-CCPCH channel.
 - Test Model 1 w/32 DPCH w/ S-CCPCH - Select this to set the active channel detection to Test Model 1 with 32 DPCH channels and 1 S-CCPCH channel.
 - Test Model 1 w/64 DPCH w/ S-CCPCH - Select this to set the active channel detection to Test Model 1 with 64 DPCH channels and 1 S-CCPCH channel.
 - Test Model 1 w/16 DPCH - Select this to set the active channel detection to the Test Model 1 with 16 DPCH channels (no S-CCPCH channel).
 - Test Model 1 w/32 DPCH - Select this to set the active channel detection to Test Model 1 with 32 DPCH channels (no S-CCPCH channel).

Test Model 1 w/64 DPCH - Select this to set the active channel detection to Test Model 1 with 64 DPCH channels (no S-CCPCH channel).

- ❑ **Test Model 2** - Press this key to access a menu to allow selections of Test Model 2, with or without S-CCPCH.

Test Model 2 w/S-CCPCH - Select this to set the active channel detection to Test Model 2 with 1 S-CCPCH channel.

Test Model 2 - Select this to set the active channel detection to Test Model 2 (no S-CCPCH channel).

- ❑ **Test Model 3** - Press this key to access a menu to allow further selections from Test Model 3 with 16 or 32 DPCH channels, and to select a Test Model with or without S-CCPCH.

Test Model 3 w/16 DPCH w/ S-CCPCH - Select this to set the active channel detection to Test Model 3 with 16 DPCH channels and 1 S-CCPCH channel.

Test Model 3 w/32 DPCH w/ S-CCPCH - Select this to set the active channel detection to Test Model 3 with 32 DPCH channels and 1 S-CCPCH channel.

Test Model 3 w/16 DPCH - Select this to set the active channel detection to Test Model 3 with 16 DPCH channels (no S-CCPCH channel).

Test Model 3 w/32 DPCH - Select this to set the active channel detection to Test Model 3 with 32 DPCH channels (no S-CCPCH channel).

- ❑ **Test Model 4** - Press this key to access a menu to allow further selections of Test Model 4.

Test Model 4 w/P-CPICH- Select this to set the active channel detection to Test Model 4 with 1 CPICH channel.

Test Model 4 - Select this to set the active channel detection to Test Model 4 (no CPICH channel).

- ❑ **Test Model 5** - Press this key to access a menu to allow further selections of Test Model 5 with 2, 4, or 8 HS-PDSCH channels.

- **Test Model 5 w/2 HS-PDSCH w/ 6 DPCH** - Select this to set the active channel detection to the Test Model 5 with 2 HS-PDSCH channels and 6 DPCH channels.

- **Test Model 5 w/4 HS-PDSCH w/ 14 DPCH** - Select this to set the active channel detection to the Test Model 5 with 4 HS-PDSCH channels and 14 DPCH channels.

- **Test Model 5 w/8 HS-PDSCH w/ 30 DPCH** - Select this to set the active channel detection to the Test Model 5 with 8 HS-PDSCH channels and 30 DPCH channels.

- **Custom** - Select this to set the define active code channel set. Active channel set can be edited via RUI. There are no keys for editing the active channel set.

NOTE

If the Power graph window is active in the **Power Graph & Metrics** view, **Code Domain (Quad View)**, or **Demod Bits** view, it uses only the spreading rate defined by the **Symbol Rate** key under the **Display** menu. (The **Composite** key under the **Display** menu is set to Off.) The width of each bar changes according to the symbol rate setting.

- **Capture Intvl** - Allows you to access a menu to set the signal capture length for a code domain power measurement.
 - **1 slot** - Select this to set the capture time to 1-slot length. Due to the lack of information to synchronize precisely, the measurement result of Demod Bits may be inaccurate.
 - **3 slot** - Select this to set the capture time to 3-slot length. Due to the lack of information to synchronize precisely, the measurement result of Demod Bits may be inaccurate.
 - **1 frame** - Select this to set the capture time to 1-frame length. Use this selection to measure PRACH messages 10 ms long.
 - **2 frame** - Select this to set the capture time to 2-frame length. Use this selection to measure PRACH messages 20 ms long.
 - **3 frame** - Select this to set the capture time to 3-frame length. This selection is not available if **Sync Type** is set to **PRACH message**.
 - **4 frame (Long Mode)**- Select this to set the capture time to 4-frame length. Under the **View/Trace** menu, the only view available is the **Demod Bits** view with the symbol power window and the demodulated bit stream window. If **Sync Type** is set to **Symbol Based**, this capture interval selection is not available.
 - **8 frame (Long Mode)**- Select this to set the capture time to 8-frame length. Only the **Demod Bits** view with the symbol power window and the demodulated bit stream window is available under the **View/Trace** menu. If **Sync Type** is set to **Symbol Based**, this capture interval selection is not available.
 - **16 frame (Long Mode)**- Select this to set the capture time to 16-frame length. Only the **Demod Bits** view with the symbol power window and the demodulated bit stream window is available under the **View/Trace** menu. If **Sync Type** is set to **Symbol Based**, this capture interval selection is not available.

- **Symbol Analysis** - Allows you to access a menu to set the following parameters:
 - **tDPCH** - Allows you to select either **Man** to manually specify the tDPCH offset value directly in integer units of 256 chips/unit or to select **Auto** to allow the instrument to search for the correct offset value . The tDPCH Offset value is the number chips from CPICH slot #0 start to DPCH slot #0 start divided by 256. Correct specification of the chip offset value is important to obtain good results for symbol measurements such as EVM, magnitude, and phase errors. The offset unit value displayed is “---” when **Auto** is selected, but tDPCH has not been detected. **tDPCH** is only available for measurements of downlink DPCH.
 - **tHS-DPCCH** - Allows you to manually specify the slot offset of the HS-DPCCH. **tDPCH** is only available for measurements of uplink tHS-DOCCH.
 - **DTX/Burst Detect**- For downlink signals, allows you to choose either **CM** (Compressed mode) or **DTX**. For uplink signals, allows you the detection of HS-DPCCH burst which sub-frame does not align with DPCCH slot boundary.
 - **Tx Diversity**- Select the rotation angle of the I/Q axis to correctly demodulate a signal with Tx Diversity. Settings are in increments of 45 degrees.
 - 0 degree
 - +45 degrees
 - +90 degrees
 - +135 degrees
 - +180 degrees
 - 45 degrees
 - 90 degrees
 - 135 degrees
- **Trig Source** - Allows you to select one of the trigger sources: **Free Run (Immediate)**, **Video (IF Envlp)**, **RF Burst (Wideband)**, **Ext Front**, **Ext Rear**, or **Frame**. The default setting is **Free Run (Immediate)**.
- **Sync Start Slot**- Allows you to specify a slot number to measure first to get a measurement result when **Sync Start Slot** is set to **On**.

Key Reference
W-CDMA Measurement Keys

- **Spectrum** - Allows you to toggle the spectrum function between **Normal** and **Invert**. If set to **Invert**, this function conjugates the spectrum, which is equivalent to taking the negative of the quadrature component in demodulation. The correct setting (**Normal** or **Invert**) depends on whether the signal being supplied to the instrument has a high or low side mix.
- **Restore Meas Defaults** - Allows you to reset the setup parameters, for the currently selected measurement only, to the factory defaults.
- **Advanced** - Allows you to access the menu to set the following parameters.
 - **Active Set Th** - Allows you to toggle the active channel detected threshold level between **Auto** and **Man**. If set to **Auto**, the active channels are determined automatically by the internal algorithm. If set to **Man**, the active channel identification for each code channel is determined by a user definable threshold ranging from 0.00 to -100.00 dB.
 - **Filter Alpha** - Allows you to specify the alpha value of the root-raised cosine filter. The range is 0.01 to 0.50.
 - **Chip Rate** - Allows you to change the chip rate. The range is 3.45600 to 4.22400 MHz.
 - **ADC Range** - Allows you to access the following selection menu to define one of the ADC ranging functions:
 - Auto** - Select this to automatically set the ADC range. For most FFT measurements, the auto feature should not be selected. An exception is when measuring a “bursty” signal, in which case **Auto** can maximize the time domain dynamic range, if FFT results are less important to you than time domain results.
 - Auto Peak** - Use this default selection to set the ADC range automatically to the peak signal level. **Auto Peak** is a compromise that works well for both CW and burst signals. If a CW signal being measured has a level that is close to the auto-ranging threshold, it is possible that the noise floor of the measurement may shift as much as 6 dB, from sweep to sweep.
 - Auto Peak Lock** - Select this to hold the ADC range automatically at the peak signal level. **Auto Peak Lock** is more stable than **Auto Peak** for CW signals, but should not be used for “bursty” signals. It may lock on a signal when the burst is absent, and set the peak too low for subsequent measurements.

- Manual** - Allows you to select a value of fixed gain to be added across the ADC range level. Correct manual range selection will provide the most accurate measurements of CW signals. Depending on the ADC in your instrument, one of the following menus will be available.
 - **-6 dB, 0 dB, +6 dB, +12 dB, +18 dB, +24 dB** (for E4406A with 12-bit ADC only).
 - **None, 0 dB, +6 dB, +12 dB, +18 dB** (for E4406A and PSA with 14-bit ADC only). Select **None** to turn off auto-ranging and retain the current range setting.
- **Multi Channel Estimator ON | OFF** - Allows you toggle the **Multi Channel Estimator** function **On** or **OFF**. More accurate measurements are produced when this function is **On**, but the measurement time increases. The default is **Off**.

TIP

Use the **Multi Channel Estimator** to improve phase measurement accuracy when you are measuring a multi-channel signal.

- **On**- Individual code channels are aligned to the pilot channel to improve the phase error of the channels.
- **Off** - Phase information for individual channels is computed based on the phase relationship of a single channel to the pilot.
- **Timing Estimation** - Allows you to select a more accurate basis for the timing estimation function. This function is only available when **Mode Setup, Advanced, Multi Channel Estimator** is set to **On**.
 - **Ch-by-Ch**- Code channel timing is calculated for each channel individually. This increases measurement time, but also increases accuracy.
 - **Global** - Code channel timing is estimated for all channels simultaneously. This method is the default when **Multi Channel Estimator** is set to **On**.

TIP

Use **Ch-by-Ch Timing Estimation** to improve phase measurement accuracy when you are measuring multi-channel signals, especially if you suspect timing error is contributing to poor measurement results.

— **Freq Err Tol Range**

This key toggles between **Wide** and **Normal** settings for Frequency Error tolerance. To accurately demodulate more complex signals which require more stringent tolerance for frequency error, like multiple channels on the same carrier, select **Normal**. You can select **Wide** for use with signals that are simpler with greater frequency error tolerance.

- **Symbol EVM Compensation** - Allows you to select a parameter to optimize Symbol EVM measurement results.
- **Frequency Compensation** - Use this setting to optimise measurement results in the frequency domain.
- **Phase Compensation** - Use this setting to optimise measurement results in the phase domain.
- **PICH Code Number**

This key allows you to enter a code number for PICH. This key is active when **Device** is set to **BTS**, it is grayed out when **MS** is selected.

- **MICH Code Number**

This key allows you to enter a code number for MICH. This key is active when **Device** is set to **BTS**, it is grayed out when **MS** is selected.

- **SCH Suppression**

This key allows you to subtract the primary and secondary SCH power leakage from other code channels during the demodulation process in the instrument. This improves symbol EVM, magnitude error and phase error measurement accuracy. Downlink channels with low coding gain can suffer interference of primary and secondary SCH, because they are not orthogonal with other code channels.

Table 3-7 shows the factory default settings for code domain power measurements.\

Table 3-7 Code Domain Power Measurement Defaults

Measurement Parameter	Factory Default Condition
View/Trace	Power Graph & Metrics
Display:	
Composite	On
Symbol Rate	15.0 ksps (grayed out)
Meas Setup:	
Meas Type	Rel (relative)
Symbol Rate	15.0 ksps
Code Number	0
Mode Scheme	Auto
I/Q Branch	Q (not available for BTS tests)
Meas Interval	1 slots
Meas Offset	0 slots
Sync Type	CPICH
Slot Format	SF0 (for Radio = MS only)
Preamble Sig	Auto; 0 (for Radio = MS only)
P-Scramble Code	0
Scramble Code Offset	0
Scramble Code Type	Std (standard)
Symbol Boundary	Auto
Capture Intvl	1 frame
Trig Source	Free Run (Immediate)
Spectrum	Normal
Meas Control:	
Measure	Single

Table 3-7 Code Domain Power Measurement Defaults

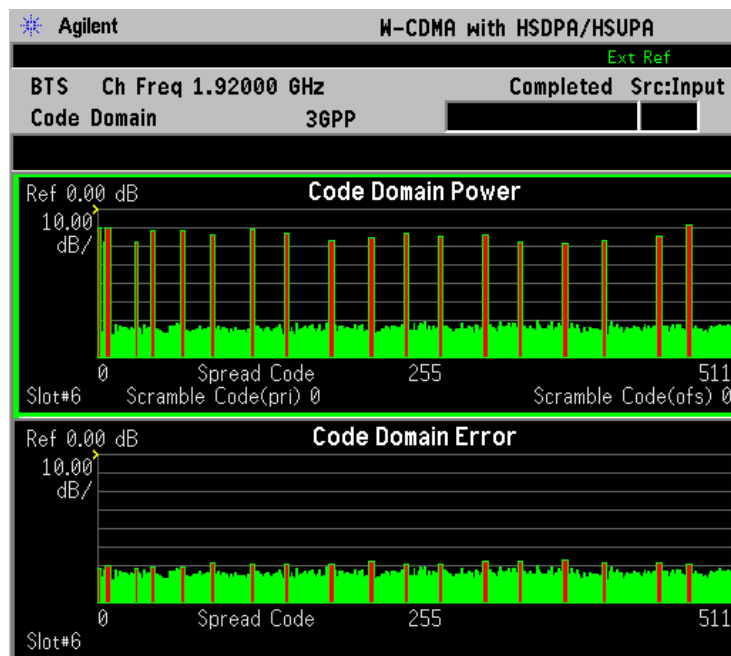
Measurement Parameter	Factory Default Condition
Advanced	
Bit Format	Binary
Active Set Th	Auto; ---- dB
Alpha	0.220
Chip Rate	3.840000 MHz
PICH Code Number	16
MICH Code Number	Off
ADC Range	-6 dB (12-bit ADC for VSA) None (14-bit ADC for VSA and PSA)
SCH Suppress (Subtract Power)	On
Multi Channel Estimator	Off
Timing Estimation	Global
Frequency Compensation	On
Phase Compensation	On

View/Trace Key Menu

Key Path: **Code Domain, View/Trace**

- **Power Graph & Metrics** - Provides a combination view of the code domain power graph and the summary data as shown in [Figure 3-13 on page 245](#). This selection is not available if **Capture Intvl** is set to Long Mode.
- **CDP Graph and CDE Graph** - Provides a combination view of the code domain power graph and code domain error graph as shown in [Figure 3-13 on page 245](#). This selection is not available if **Capture Intvl** is set to Long Mode.

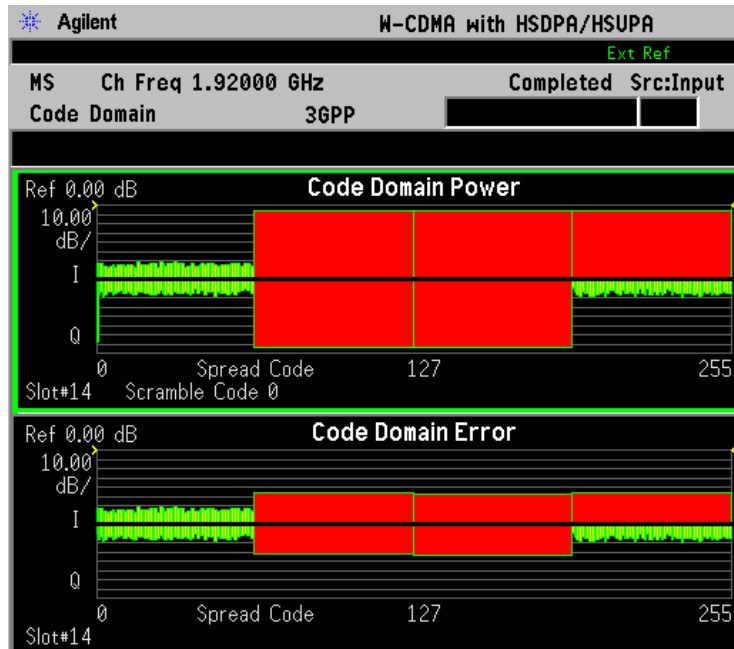
Figure 3-13 Code Domain Measurement - CDP Graph & CDE Graph (BTS)



*Meas Setup: View/Trace = CDP Graph & CDE Graph

*Input signals: -30.00 dBm, Test Model 1 with 16 DPCH

Figure 3-14 Code Domain Measurement - CDP Graph & CDE Graph (MS)

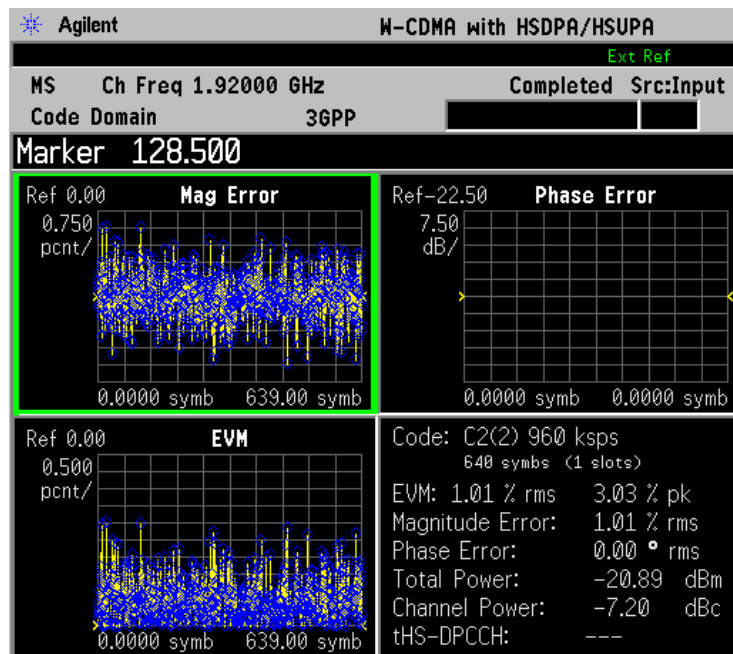


*Meas Setup: View/Trace = CDP Graph & CDE Graph

*Input signals: -30.00 dBm, DPCCH + 5 DPDCH

- **I/Q Error (Quad View)** - Provides a combination view of the magnitude error, phase error, EVM graphs, and the summary data for the code number, rms EVM, peak EVM, magnitude error, phase error, total power, channel power, and tDPCH as shown in [Figure 3-15](#). This selection is not available if **Capture Intvl** is set to Long Mode.

Figure 3-15 Code Domain Measurement - I/Q Error Quad View



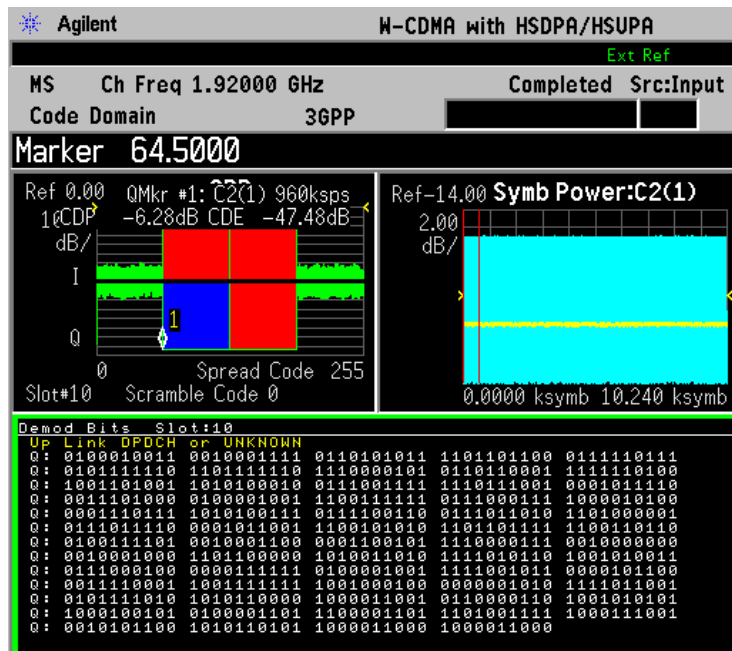
*Meas Setup: View/Trace = I/Q Error (Quad View)

*Input signals: -10.00 dBm, PCCPCH + SCH + 3 DPCH + CPICH

Key Reference
W-CDMA Measurement Keys

- **Code Domain (Quad View)** - Provides a combination view of the code domain power, symbol power, I/Q symbol polar vector graphs, and the summary data for the code number, rms EVM, peak EVM, magnitude error, phase error, total power, channel power, and tDPCH as shown in [Figure 3-16](#). In this example, the symbol power C8(0) is for the code 8 at the spread code number 0 in the code power graph window. Two white line markers denote that the measurement offset is 0 slot and the measurement interval is 1 slot. The symbol power within these markers is analyzed to show the I/Q vector trajectory. This selection is not available if **Capture Intvl** is set to Long Mode.

Figure 3-16 Code Domain Measurement - Code Domain Quad View



*Meas Setup: View/Trace = Code Domain (Quad View),
Others = Factory default settings

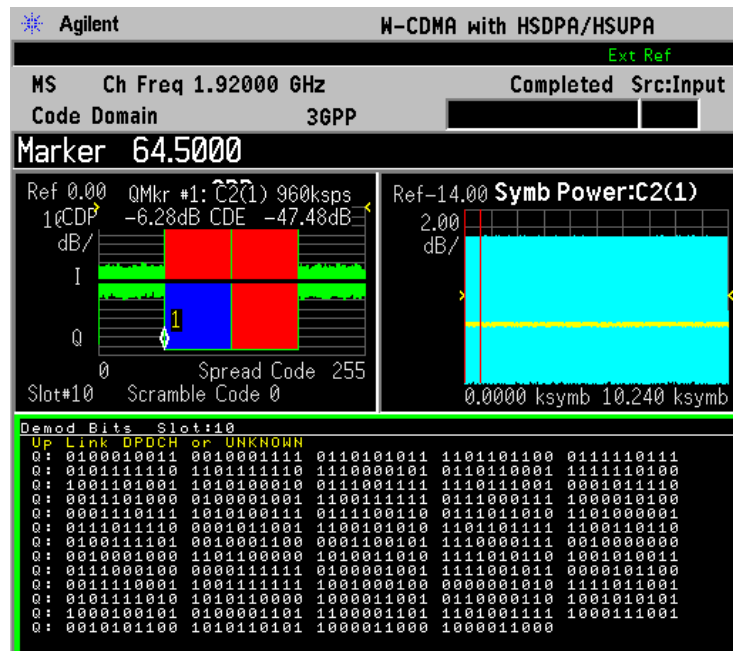
*Input signals: -10.00 dBm, DPCH + 5 DPDCH

- **Demod Bits** - Provides a combination view with the code domain power and symbol power graphs in the graph window. The demodulated I/Q bit stream data for the symbol power slots selected by the measurement interval and measurement offset are in the text window as shown in Figure 3-17. This is the I/Q bit stream for the symbol power between the white line markers shown in the window and it does not include any bits that occur during the tDPCH offset.

If **Sync Type** is set to **Symbol Based**, the demod bits view is not available.

If **Capture Intvl** is set to **4 frame (Long Mode)**, this display changes to a combination view with the symbol power window and 3 separate demodulated bit stream windows.

Figure 3-17 Code Domain Measurement - Demod Bits View (Single Slot)



*Meas Setup: View/Trace = Demod Bits,
Others = Factory default settings

*Input signals: -10.00 dBm, PCCPCH + SCH + 3 DPCH

While the Code Domain Power window is active, press the **Marker** key to place a marker on any active spread channel. Then, press the **Mkr->Despread** key to observe the Symbol Power and the Symbol EVM Polar Vector graphs with the spread code number for that active channel in other graph windows. The I/Q symbol polar vector graph and the demodulated bit stream are displayed for the symbol power specified by the measurement interval and measurement offset.

Display Key Menu

Key Path: Code Domain, **Display**

NOTE In code domain measurements, phase trajectories between constellation points are not significant in determining symbol EVM. Therefore, the points per chip is always set to 1 and the **Chip Dots** display function is set to **On**.

NOTE The following additional keys appear in **Power Graph & Metrics**, **Code Domain (Quad View)**, or **Demod Bits** view when the Power graph window is active.

- **Composite** - Allows you to toggle the composite code channel power display function between **On** and **Off**. The default setting is **On**. This key is grayed out if **Capture Intvl** is set to **Long Mode**.
 - **Symbol Rate** - Allows you to change the display symbol rate to read the combined code power levels, if **Composite** is set to **Off**. The width of each bar changes according to the symbol rate setting.
-

NOTE The following additional key appears in **Code Domain (Quad View)**, or **Demod Bits** view when the Symb Power graph window is active.

- **Composite Chip Power** - Allows you to toggle the composite chip power display function between **On** and **Off**. The default setting is **On**. This selection is disabled if **Capture Intvl** is set to Long Mode.
-

NOTE The following additional keys appear in **Demod Bits** view when the Demod Bits graph window is active.

- **Prev Page** - Returns one page back to the previous page of the measurement results.
- **Next Page** - Moves one page forward to the next page of the measurement results.
- **Scroll Up** - Moves one line upward from the current page of the measurement results by each pressing.
- **Scroll Down** - Moves one line downward from the current page of the measurement results by each pressing.
- **First Page** - Moves from the current page to the first page of the measurement results.
- **Last Page** - Moves from the current page to the last page of the measurement results.
- **Demod Bit Format** - Use this key to toggle the default **Binary** selection to **Hex**. For QPSK, channels have 2 bits/symbol, with the index bits

are always displayed in binary format. If the Modulation Scheme is 16QAM, channels have 4 bits/symbol, and you may select either format for the screen data presentation. When Binary is selected, each character represents a binary digit. When Hex is selected, each character represents a hexadecimal digit. The characters “I1, Q1, I2, Q2” to the left of each row of data displayed indicates the row’s index.

NOTE

The following additional keys appear in **Power Graph & Metrics, Code Domain (Quad View)**, or **Demod Bits** view when the Power graph window is active.

- **SPAN X Scale**

- **Scale/Div** - Allows you to set the horizontal scale by changing a spread code value. The range is 64.00 to 512.0 spread codes. The default setting is 512.0 spread codes.
- **Ref Value** - Allows you to set the spread code reference value. The range is 0.000 to 448.0 spread codes with the scale at least 64 spread codes. The default setting is 0.000 spread code.
- **Ref Position** - Allows you to set the reference position to either **Left**, **Ctr** (center) or **Right**. The default setting is **Left**.
- **Expand** - Allows you to toggle the expanding function of the code domain power graph between **On** and **Off**. If set to **On**, the CDP graph is expanded horizontally to show 64 spread codes centered at the scale or the marker position. Upon toggling back to **Off**, the spread code range returns to the previous setting.

- **AMPLITUDE Y Scale**

- **Scale/Div** - Allows you to set the vertical scale by changing the value per division. The range is 0.10 to 20.0 dB per division. The default setting is 10.00 dB.
- **Ref Value** - Allows you to set the reference value ranging from -250.00 to 250.00 dB. The default setting is 0.00 dB. If **Meas Type** is set to **Abs** (absolute), the reference value and measurement results are shown in dBm.

NOTE

The following additional keys appear in **Code Domain (Quad View)**, or **Demod Bits** view when the Symbol Power graph window is active.

- **SPAN X Scale**

- **Scale/Div** - Allows you to set the horizontal scale by changing a symbol value per division. The range is 0.1 to 500000.0 symbols per division with 0.01 symbol resolution. The default setting is 30.99 symbols. When the **Scale Coupling** default setting **On** is in effect, displayed plots use a Scale/Div value determined by the analyzer, based on the measurement result.
- **Ref Value** - Allows you to set the symbol reference value ranging from 0.000 to 5000000.0 symbols. The default setting is 0.000 symbol. When the **Scale Coupling** default setting **On** is in effect, displayed plots use a Scale/Div value determined by the analyzer, based on the measurement result.
- **Ref Position** - Allows you to set the reference position to either **Left**, **Ctr** (center) or **Right**. The default setting is **Left**.
- **Scale Coupling** - Allows you to toggle the scale coupling function between **On** and **Off**. The default setting is **On**. Upon pressing the **Restart** front panel key or **Restart** softkey under the **Meas Control** menu, this function automatically determines the scale per division and reference values based on the measurement results.

- **AMPLITUDE Y Scale**

- **Scale/Div** - Allows you to set the vertical scale by changing the value per division. The range is 0.10 to 20.0 dB per division. The default setting is 10.00 dB. When the **Scale Coupling** default setting **On** is in effect, displayed plots use a Scale/Div value determined by the analyzer, based on the measurement result.
- **Ref Value** - Allows you to set the reference value ranging from -250.00 to 250.00 dBm. The default setting is 0.00 dBm. When the **Scale Coupling** default setting **On** is in effect, displayed plots use a Scale/Div value determined by the analyzer, based on the measurement result.
- **Ref Position** - Allows you to set the reference position to either **Top**, **Ctr** (center) or **Bot** (bottom). The default setting is **Ctr**.
- **Scale Coupling** - Allows you to toggle the scale coupling function between **On** and **Off**. The default setting is **On**. Upon pressing the **Restart** front panel key or **Restart** softkey under the **Meas Control** menu, this function automatically determines the scale per division and reference values based on the measurement results.

NOTE The following additional keys appear in **I/Q Error (Quad View)** view when the EVM, Phase Error, or Mag Error window is active.

- **SPAN X Scale**
 - **Scale/Div** - Allows you to set the horizontal scale by changing a symbol value per division. The range is 0.100. When the **Scale Coupling** default setting **On** is in effect, displayed plots use a Scale/Div value determined by the analyzer, based on the measurement result.
 - **Ref Value** - Allows you to set the symbol reference value ranging from 0.00 to 1000.0 symbols. The default setting is 0.00 symbol. When the **Scale Coupling** default setting **On** is in effect, displayed plots use a Scale/Div value determined by the analyzer, based on the measurement result.
 - **Ref Position** - Allows you to set the reference position to either **Left**, **Ctr** (center) or **Right**. The default setting is **Left**.
 - **Scale Coupling** - Allows you to toggle the scale coupling function between **On** and **Off**. The default setting is **On**. Upon pressing the **Restart** front panel key or **Restart** softkey under the **Meas Control** menu, this function automatically determines the scale per division and reference values based on the measurement results.

NOTE The following additional keys appear in **I/Q Error (Quad View)** view when the EVM or Mag Error window is active.

- **AMPLITUDE Y Scale**
 - **Scale/Div** - Allows you to set the vertical scale by changing the value per division. The range is 0.100 to 50.0% per division. The default setting is 5.00%. When the **Scale Coupling** default setting **On** is in effect, displayed plots use a Scale/Div value determined by the analyzer, based on the measurement result.
 - **Ref Value** - Allows you to set the reference value ranging from -500.00 to 500.0%. The default setting is 0.00%. When the **Scale Coupling** default setting **On** is in effect, displayed plots use a Scale/Div value determined by the analyzer, based on the measurement result.
 - **Ref Position** - Allows you to set the reference position to either **Top**, **Ctr** (center) or **Bot** (bottom). For the EVM graph, the default setting is **Bot**. For the Mag Error graph, the default setting is **Ctr**.

- **Scale Coupling** - Allows you to toggle the scale coupling function between **On** and **Off**. The default setting is **On**. Upon pressing the **Restart** front panel key or **Restart** softkey under the **Meas Control** menu, this function automatically determines the scale per division and reference values based on the measurement results.

NOTE

The following additional keys appear in **I/Q Error (Quad View)** view when the **Phase Error** window is active.

- **AMPLITUDE Y Scale**
 - **Scale/Div** - Allows you to set the vertical scale by changing the value per division. The range is 0.0100 to 3600.0 degrees. The default setting is 5.00 degrees. When the **Scale Coupling** default setting **On** is in effect, displayed plots use a Scale/Div value determined by the analyzer, based on the measurement result.
 - **Ref Value** - Allows you to set the reference value ranging from -36000.0 to 36000.0 degrees. The default setting is 0.00 degrees. When the **Scale Coupling** default setting **On** is in effect, displayed plots use a Scale/Div value determined by the analyzer, based on the measurement result.
 - **Ref Position** - Allows you to set the reference position to either **Top**, **Ctr** (center) or **Bot** (bottom). The default setting is **Ctr**.
 - **Scale Coupling** - Allows you to toggle the scale coupling function between **On** and **Off**. The default setting is **On**. Upon pressing the **Restart** front panel key or **Restart** softkey under the **Meas Control** menu, this function automatically determines the scale per division and reference values based on the measurement results.

Marker Key Menu

Key Path: **Code Domain, Marker**

- **Select** - Allows you to activate up to four markers with the corresponding numbers, respectively. The selected number is underlined and its function is defined by pressing the **Function** key. The default setting is 1.
- **Normal** - Allows you to activate the selected marker to read the power level and symbol code with the code layer of the marker position. Marker position is controlled by the RPG knob.
- **Delta** - Allows you to read the differences in the power levels and symbols codes between the selected marker and the next.

- **Function** - Allows you to set the selected marker function to **Band Power**, **Noise**, or **Off**. The default setting is **Off**. The **Band Power** and **Noise** functions are not available for this measurement.
- **Trace** - Allows you to place the selected marker on the various traces displayed: **EVM (in chip)**, **Phase Error**, **Mag Error**, **Chip Power**, **Symbol Power**, **Code Domain Power**, **EVM (in slot)**, and **CDE** (Code Domain Error). The default setting is **Code Domain Power**.
- **Off** - Allows you to turn off the selected marker.
- **Shape** - Allows you to access the menu to set the selected marker shape to **Diamond**, **Line**, **Square**, or **Cross**. The default setting is **Diamond**.
- **Marker All Off** - Allows you to turn off all of the markers.
- **Mkr->Despread** - While a maker is set on any active spread channel of the code domain power graph in the **Power Graph and Metrics**, **Code Domain (Quad View)**, or **Demod Bits** view, this key allows you to observe the Symbol Power and the I/Q Symbol Polar Vector graphs with the OVSF spread code number for that active channel in other windows. The I/Q symbol polar vector graph is displayed for the symbol power specified by the measurement interval and measurement offset.

Print Demod Key

NOTE

The following key appears when **View/Trace** is set to **Demod Bits**.

- **Print Demod** - Allows you to toggle the print function between **Screen** and **Report**. The default setting is **Screen**. If you want to get text data of the demodulated bits, press **HCOPY Dest = Print To Key** in the **Print Setup** key menu. Then press **Print Demod** to select Report. Then press **Print** to obtain the text file "Demodbit.txt".

Intermod Keys

NOTE You must have selected Intermod under the **MEASURE** key to access the following menus.

Meas Setup Key Menu

Key Path: Intermod, **Meas Setup**

- **Meas Mode** - Allows you to specify one of the following measurement modes:
 - **Auto** - Automatically identifies the intermodulation caused by either the two-tone or transmit intermodulation signals and that mode is labeled in the middle line of the **Meas Mode** key. If appropriate signals are not identified, “-----” is shown instead.
 - **Two-tone** - Measures the two-tone intermodulation products.
 - **Transmit IM** - Measures the transmit intermodulation products.
- **Reference** - Allows you to access the selection menu for the reference channel.
 - **Auto** - Select this to set the reference channel automatically to the highest level signal in two base frequency signals.
 - **Lower Freq** - Select this to set the reference channel to the base lower frequency signal.
 - **Upper Freq** - Select this to set the reference channel to the base upper frequency signal.
 - **Average** - Select this to set the reference channel to the average frequency signals, (base lower frequency signal + base upper frequency signal)/2.
- **Span** - Allows you to specify the frequency span in which intermodulation products are measured. The range is 100.000 kHz to 100.000 MHz with 1 Hz resolution.
- **Res BW** - Allows you to specify the resolution bandwidth in which intermodulation products are measured, and to toggle this function between **Auto** and **Man**. If set to **Auto**, the resolution bandwidth is automatically set according to the frequency span. The range is 100.0 Hz to 300.000 kHz with 1 Hz resolution.
- **Base Freq Auto Search** - Allows you to toggle the base frequency auto search function between **On** and **Off**. If set to **On**, the base frequency is automatically searched for. When set to **Off**, the base frequencies may be initiated using the **Base Freq** settings, below.

- **Base Freq** - Allows you to initiate the base frequency values of the following items when **Base Freq Auto Search** is set to **Off** (otherwise this key is not available). The actual frequencies used for the measurement are calculated as a function of the other base frequencies input, and the **Delta** step increment setting:
 - **Lower Freq (f0)** - Accepts a frequency value for the base lower frequency (f0). The range is 1 kHz to 3.000 GHz for PSA, and 1 kHz to 4.3214 GHz for E4406A.
 - **Upper Freq (f1)** - Accepts a frequency value for the base upper frequency (f1). The range is 1 kHz to 3.000 GHz for PSA, and 1 kHz to 4.3214 GHz for E4406A.
 - **Delta (f1 – f0)** - Automatically shows the difference between the base lower and base upper frequencies. The range is –3.000 to 3.000 GHz for PSA and –4.3214 GHz to 4.3214 GHz for E4406A. The **Delta** step increment setting (default = 1MHz) may be changed using the step increment command:
`[:SENSe] :FREQuency :CENTer :STEP [:INCRement]`
- **Restore Meas Defaults** - Allows you to preset only the settings that are specific to the selected measurement by pressing **Meas Setup, More (1 of 2), Restore Meas Defaults**. This will set the measure setup parameters, for the currently selected measurement only, to the factory defaults.
- **Advanced** - Allows you to access the menu to set the following items:
 - **RRC Filter** - Allows you to toggle the root-raised cosine filter function between **On** and **Off**.
 - **Alpha** - Allows you to specify the alpha value of the root-raised cosine filter. The range is 0.01 to 0.50.
 - **Integ BW** - Allows you to specify the integration bandwidth. The range is 100.000 kHz to 5.00000 MHz with 1 kHz resolution.

Table 3-8 shows the factory default settings for intermodulation measurements.

Table 3-8 Intermodulation Measurement Defaults

Measurement Parameter	Factory Default Condition
Display: IM Prod Ref	On
Meas Setup:	
Avg Number	10; On
Avg Mode	Repeat
Meas Mode	Two-tone, Transmit IM, or -----; Auto
Reference	Lower Freq or Upper Freq; Auto
Span	50.0000 MHz
Res BW	140.000 kHz; Auto
Base Freq Auto Search	On
Base Freq	(not available as Base Freq Auto Search is set to On)
Advanced	
RRC Filter	On
Alpha	0.220
Integ BW	3.84000 MHz

View/Trace Key Menu

The **View/Trace** key is not available for this measurement.

Display Key Menu

Key Path: **Intermod, Display**

NOTE

The following additional keys appear when the Spectrum graph window is active.

- **Scale/Div** - Allows you to enter a numeric value to change the vertical display sensitivity. The range is 0.10 to 20.00 dB with 0.01 dB resolution. The default setting is 10.00 dB. When the **Scale Coupling** default setting **On** is in effect, displayed plots use a Scale/Div value determined by the analyzer, based on the measurement result.

- **Ref Value** - Allows you to set the absolute power reference value ranging from -250.00 to 250.00 dBm with 0.01 dB resolution. The default setting is 10.00 dBm. When the **Scale Coupling** default setting **On** is in effect, displayed plots use a Scale/Div value determined by the analyzer, based on the measurement result.
- **Ref Position** - Allows you to set the reference position to either **Top**, **Ctr** (center), or **Bot** (bottom). The default setting is **Top**.
- **Scale Coupling** - Allows you to toggle the scale coupling function between **On** and **Off**. The default setting is **On**. Upon pressing the **Restart** front panel key or **Restart** softkey under the **Meas Control** menu, this function automatically determines the scale per division and reference values based on the measurement results.
- **IM Prod Ref** - Allows you to toggle the display function of the intermodulation product reference lines between **On** and **Off**. If set to **On**, two pair of dual vertical lines with the integration bandwidth are shown on the third-order and fifth-order intermodulation products display.

Marker Key Menu

Key Path: Intermod, **Marker**

- **Select 1 2 3 4** - Allows you to activate up to four markers with the corresponding numbers, respectively. The selected number is underlined and its function is defined by pressing the **Function** key. The default is 1.
- **Normal** - Allows you to activate the selected marker to read the frequency and amplitude of the marker on the Spectrum trace. Marker position is controlled by the **RPG** knob.
- **Delta** - Allows you to read the differences in time positions and amplitudes between the selected marker and the next.
- **Function** - Allows you to define the selected marker function to be **Band Power**, **Noise**, or **Off**. The default is **Off**. For measuring **Band Power**, you need to place the **Normal** marker and then place the **Delta** marker.
- **Trace** - Allows you to place the selected marker on the **Spectrum** trace.
- **Off** - Allows you to turn off the selected marker.
- **Shape Diamond** - Allows you to access the menu to define the selected marker shape to be **Diamond**, **Line**, **Square**, or **Cross**. The default shape is **Diamond**.
- **Marker All Off** - Allows you to turn off all of the markers.

Mod Accuracy (Composite EVM) Keys

NOTE You must have selected **Mod Accuracy (Composite EVM)** under the **MEASURE** key to access the following menus.

Meas Setup Key Menu

Key Path: **Meas Setup**

NOTE Do not adjust the measurement interval in this measurement since Rho is always calculated from the whole Perch slot (except the search code symbol) with 2304 chips. You may adjust the Capture Interval, see below.

- **Avg Number** - Allows you to change the number of N averages.
- **Avg Mode** - Allows you to toggle the averaging mode between **Exp** (exponential) and **Repeat**. This selection only effects on the averaging result after the number of N averages is reached. The N is set using the **Avg Number** key.
 - **Exp** - Exponential averaging: When **Measure** is set to **Cont**, data acquisition will continue indefinitely. Exponential averaging is used with a weighting factor of N (the displayed count of averages stops at N). Exponential averaging weights new data more heavily than old data, which allows tracking of slow-changing signals. The weighting factor N is set using the Avg Number key.
 - **Repeat** averaging: When **Measure** is set to **Cont**, data acquisition will continue indefinitely. After the number of N averages is reached, all previous result data is cleared and the average count displayed is set back to 1. This is equivalent to being in **Measure Single** and pressing the **Restart** key each time the single measurement finishes.
- **Capture Intvl** - Allows you to access a menu to set the signal capture length.
 - **1 slot** - Select this to set the capture time to 1-slot length.
 - **3 slot** - Select this to set the capture time to 3-slot length.
 - **1 frame** - Select this to set the capture time to 1-frame length.

- **Meas Offset** - Allows you to set the number of offset slots to make the mod accuracy measurement. The minimum setting (default) is 0. The maximum value is (**Capture Interval** value – 1).
- **Limits** - Allows you to access the menu to set the following limits:
 - **RMS EVM (Composite)** - Allows you to set the limit for composite RMS EVM measurement pass/fail test. The range is 0.00 to 100.00%.
 - **Peak EVM (Composite)** - Allows you to set the limit for composite peak EVM measurement pass/fail test. The range is 0.00 to 200.00%.
 - **Rho (Composite)** - Allows you to set the limit for composite Rho measurement pass/fail test. The range is 0.00000 to 1.00000.
 - **Peak Code Domain Error** - Allows you to set the limit for composite peak code domain error measurement pass/fail test. The range is –100.0 to 0.0 dB. For MS tests, the default is -14 dB at C2 SF4.
 - **Frequency Error** - Allows you to set the limit for frequency error measurement pass/fail test. The range is 0.0 to 500.0 Hz.
 - **CPICH Reference** - Allows you to set the limit for CPICH Reference measurement pass/fail test. The range is –100.0 to 0.0 dB.
 - **CPICH Tolerance** - Allows you to set the limit for CPICH Tolerance measurement pass/fail test. The range is 0.0 to 1000.0 dB.

NOTE

These limit settings are displayed graphically as blue horizontal lines in the **View/Trace, Slot CDE/EVM** view.

- **Sync Type** - Allows you to access the following menu to select the channel to be synchronized with, if **Device** is set to **BTS**:
 - **CPICH** - Allows you to synchronize with the CPICH channel.
 - **SCH** - Allows you to synchronize with the SCH channel.
 - **Symbol Based** - Allows you to access the menu for the code symbol to synchronize with.
 - Symbol Rate** - Allows you to set the symbol rate ranging from 7.5 to 960 kbps. The parameter automatically sets the maximum value for **Code Number** when appropriate.
 - Code Number** - Allows you to set the code number. The range is 0 to 511 depending on the **Symbol Rate** setting.

- **Antenna-2 CPICH** - Allows you to synchronize with the STTD Antenna-2 common pilot channel.
- **STTD Diff** - Allows you to synchronize with the common pilot channel channel at STTD antenna-1 and antenna-2 to make Diversity Time Error measurements.
- **TSTD SCH Antenna-1** - Allows you to synchronize with the antenna1 of TSTD SCH.
- **TSTD SCH Antenna-2** - Allows you to synchronize with the antenna2 of TSTD SCH.

When **Device** is set to **MS**, the following **Sync Type** selections are available:

- **DPCCH** - DPCCH is searched for synchronization.
- **PRACH Message** - PRACH Message control portion is searched for synchronization.
- **Slot Format** - Defines the DPCCH pilot pattern to synchronize with, and allows you to enter an integer from SF0 to SF5 or to select **Auto**. This key is available when **DPCCH** is selected under **Sync Type**.
- **Preamble Sig** - If **Synch Type** is set to **PRACH Message**, this selection allows you to set a signature pattern from 0 to 15 or to select **Auto** to perform an automatic search. This key is available when **PRACH Message** is selected under **Sync Type**.
- **P-Scramble Code** - Allows you to enter a numeric value for the primary scramble code. The range is 0 to 511. This key is available when **Device** is set to **BTS**.
- **Scramble Code Offset** - Allows you to set the number of scramble code offsets to make the modulation accuracy measurement. The range is 0 to 15. This key is available when **Device** is set to **BTS**.
- **Scramble Code** - Allows you to enter a hexadecimal value for the scramble code. The range is 0 to 0xFFFFFFFF. Pressing this key reveals the keys labeled **A** through **F** and **Done**. Use these keys and the numeric keypad to enter a hexadecimal value by terminating with the **Done** key. This key is available when **Device** is set to **MS**.
- **Scramble Code Type** - Allows you to set the scramble code type to either **Std** (standard), **Left**, or **Right** to make the modulation accuracy measurement. This key is available when **Device** is set to **BTS**.

- **Symbol Boundary** - Allows you to access the selection menu for the symbol boundary detection mode which specifies how active channels are detected.
 - **Auto** - Select this to set the symbol boundary detection to the automatic mode. Various code channels are measured and the most appropriate code channel is selected as the reference channel.
 - **Custom** - Select this to set the symbol boundary detection to the automatic mode. Various code channels are measured and the most appropriate code channel is selected as the reference channel.
 - **Predefined Test Models** - Allows you to access selection menus for the test models by number, then further selection of various combinations of channels to be detected as active. Channels specified by a Test Model are always detected as active regardless of the power level or modulation quality.
 - **Test Model 1** - Press this key to access a menu to allow further selections of Test Model 1 with 16, 32 or 64 DPCH channels, and to select a Test Model with or without S-CCPCH.
 - Test Model 1 w/16 DPCH w/ S-CCPCH - Select this to set the active channel detection to Test Model 1 with 16 DPCH channels and 1 S-CCPCH channel.
 - Test Model 1 w/32 DPCH w/ S-CCPCH - Select this to set the active channel detection to Test Model 1 with 32 DPCH channels and 1 S-CCPCH channel.
 - Test Model 1 w/64 DPCH w/ S-CCPCH - Select this to set the active channel detection to Test Model 1 with 64 DPCH channels and 1 S-CCPCH channel.
 - Test Model 1 w/16 DPCH - Select this to set the active channel detection to Test Model 1 with 16 DPCH channels (no S-CCPCH channel).
 - Test Model 1 w/32 DPCH - Select this to set the active channel detection to Test Model 1 with 32 DPCH channels (no S-CCPCH channel).
 - Test Model 1 w/64 DPCH - Select this to set the active channel detection to Test Model 1 with 64 DPCH channels (no S-CCPCH channel).

Key Reference
W-CDMA Measurement Keys

- ❑ **Test Model 2** - Press this key to access a menu to allow selections of Test Model 2, with or without S-CCPCH.

Test Model 2 w/S-CCPCH - Select this to set the active channel detection to Test Model 2 with 1 S-CCPCH channel.

Test Model 2 - Select this to set the active channel detection to Test Model 2 (no S-CCPCH channel).

- ❑ **Test Model 3** - Press this key to access a menu to allow further selections from Test Model 3 with 16 or 32 DPCH channels, and to select a Test Model with or without S-CCPCH.

Test Model 3 w/16 DPCH w/ S-CCPCH - Select this to set the active channel detection to Test Model 3 with 16 DPCH channels and 1 S-CCPCH channel.

Test Model 3 w/32 DPCH w/ S-CCPCH - Select this to set the active channel detection to Test Model 3 with 32 DPCH channels and 1 S-CCPCH channel.

Test Model 3 w/16 DPCH - Select this to set the active channel detection to Test Model 3 with 16DPCH channels (no S-CCPCH channel).

Test Model 3 w/32 DPCH - Select this to set the active channel detection to Test Model 3 with 32 DPCH channels (no S-CCPCH channel).

- ❑ **Test Model 4** - Press this key to access a menu to allow further selections of Test Model 4.

Test Model 4 w/P-CPICH- Select this to set the active channel detection to Test Model 4 with 1 CPICH channel.

Test Model 4 - Select this to set the active channel detection to Test Model 4 (no CPICH channel).

- ❑ **Test Model 5** - Press this key to access a menu to allow further selections of Test Model 5 with 2, 4, or 8 HS-PDSCH channels.

- **Test Model 5 w/2 HS-PDSCH w/ 6 DPCH** - Select this to set the active channel detection to the Test Model 5 with 2 HS-DPDSCH channels and 6 DPCH channels.

- **Test Model 5 w/4 HS-PDSCH w/ 14 DPCH** - Select this to set the active channel detection to the Test Model 5 with 4 HS-DPDSCH channels and 14 DPCH channels.

Test Model 5 w/8 HS-PDSCH w/ 30 DPCH - Select this to set the active channel detection to the Test Model 5 with 8 HS-PDSCH channels and 30 DPCH channels.

- **Sync Start Slot**- Allows you to specify a slot number to measure first to get a measurement result when **Sync Start Slot** is set to **On**.

- **Spectrum** - Allows you to toggle the spectrum function between **Normal** and **Invert**. If set to **Invert**, this function conjugates the spectrum, which is equivalent to taking the negative of the quadrature component in demodulation. The correct setting (**Normal** or **Invert**) depends on whether the signal at the input of the instrument has a high or low side mix.
- **Restore Meas Defaults** - Allows you to reset the measure setup parameters, for the currently selected measurement only, to the factory defaults.
- **Advanced** - Allows you to access the menu to change the following parameters:
 - **EVM Result I/Q Offset** - Allows you to toggle the I/Q origin offset function between **Std** (standard) and **Exclude**. If set to **Std**, the measurement results for EVM, Rho, and code domain error take into account the I/Q origin offset. If set to **Exclude**, the measurement results for EVM, Rho, and code domain error do not take into account the I/Q origin offset, and the message “EVM excludes I/Q Offset” is displayed in the lower right-hand graph display area. The default setting is **Std**.
 - **Active Set Th** - Allows you to toggle the active channel detection threshold level between **Auto** and **Man**. If set to **Auto**, the active channels are determined automatically by the internal algorithm. If set to **Man**, the active channel identification is determined by a user definable threshold ranging from 0.00 to -100.00 dB. The default setting is **Auto**.
 - **Filter Alpha** - Allows you to change the alpha value of the root-raised cosine filter. The range is 0.01 to 0.50.
 - **Chip Rate** - Allows you to change the chip rate ranging from 3.45600 to 4.22400 MHz.
 - **ADC Range** - Allows you to access the following selection menu to define one of the ADC ranging functions:
 - Auto** - Select this to automatically set the ADC range. For most FFT measurements, the auto feature should not be selected. An exception is when measuring a “bursty” signal, in which case **Auto** can maximize the time domain dynamic range, if FFT results are less important to you than time domain results.
 - Auto Peak** - Use this default selection to set the ADC range automatically to the peak signal level. **Auto Peak** is a compromise that works well for both CW and burst signals. If a CW signal being measured has a level that is close to the auto-ranging threshold, it is possible that the noise floor of the measurement may shift as much as 6 dB, from sweep to sweep.

Key Reference
W-CDMA Measurement Keys

- ❑ **Auto Peak Lock** - Select this to hold the ADC range automatically at the peak signal level. **Auto Peak Lock** is more stable than **Auto Peak** for CW signals, but should not be used for “bursty” signals. It may lock on a signal when the burst is absent, and set the peak too low for subsequent measurements.
- ❑ **Manual** - Allows you to select a value of fixed gain to be added across the ADC range level. Correct manual range selection will provide the most accurate measurements of CW signals. Depending on the ADC in your instrument, one of the following menus will be available.
 - **-6 dB, 0 dB, +6 dB, +12 dB, +18 dB, +24 dB** (for E4406A with 12-bit ADC only).
 - **None, 0 dB, +6 dB, +12 dB, +18 dB (for E4406A and PSA with 14-bit ADC only)**. Select **None** to turn off auto-ranging and retain the current range setting.
- **DTX/Burst Detect**- For downlink signals, allows you to choose either **CM** (Compressed mode) or **DTX**. For uplink signals, allows you the detection of HS-DPCCH burst which sub-frame does not align with DPCCH slot boundary.
- **Multi Channel Estimator ON|OFF** - Allows you toggle the **Multi Channel Estimator** function **On** or **Off**. More accurate measurements are produced when this function is **On**, but the measurement time increases. The default is **Off**.
 - **On**- Individual code channels are aligned to the pilot channel to improve the phase error of the channels.
 - **Off** - Phase information for individual channels is computed based on the phase relationship of a single channel to the pilot.

TIP

Use the **Multi Channel Estimator** to improve phase measurement accuracy when you are measuring a multi-channel signal.

- **Timing Estimation** - Allows you to select a more accurate basis for the timing estimation function. This function is only available when **Mode Setup, Advanced, Multi Channel Estimator** is set to **On**.
 - **Ch-by-Ch**- Code channel timing is calculated for each channel individually. This increases measurement time, but also increases accuracy.
 - **Global** - Code channel timing is estimated for all channels simultaneously. This method is the default when **Multi Channel Estimator** is set to **On**.

TIP Use **Ch-by-Ch Timing Estimation** to improve phase measurement accuracy when you are measuring multi-channel signals, especially if you suspect timing error is contributing to poor measurement results.

— **Freq Err Tol Range** - This key toggles between **Wide** and **Normal** settings for Frequency Error tolerance. To accurately demodulate more complex signals which require more stringent tolerance for frequency error, like multiple channels on the same carrier, select **Normal**. You can select **Wide** for use with signals that are simpler with greater frequency error tolerance.

— **PICH Code Number**

This key allows you to enter a code number for PICH.

— **MICH Code Number**

This key allows you to enter a code number for MICH. This key is active when **Device** is set to **BTS**, it is grayed out when **MS** is selected.

[Table 3-9](#) shows the factory default settings for modulation accuracy (composite EVM) measurements.

Table 3-9 Modulation Accuracy (Composite EVM) Measurement Defaults

Measurement Parameter	Factory Default Condition
View/Trace	I/Q Measured Polar Vector
Display: Chip Offset I/Q Chips Interpolation +45 deg Rot Full Vector (Background) Time Offset Unit	0 chips 2560 chips Off Off Off Chip
Meas Setup:	
Avg Number	10; On
Avg Mode	Repeat
Limits: RMS EVM (Composite) Peak EVM (Composite) Rho (Composite) Peak Code Domain Error Frequency Error CPICH Reference CPICH Tolerance	17.5 pcnt 200.0 pcnt 0.50000 -32.0 dB (at C8 SF256) 100.0 Hz -10.0 dB 100.0 dB
Trig Source	Free Run (Immediate)

Table 3-9 Modulation Accuracy (Composite EVM) Measurement Defaults

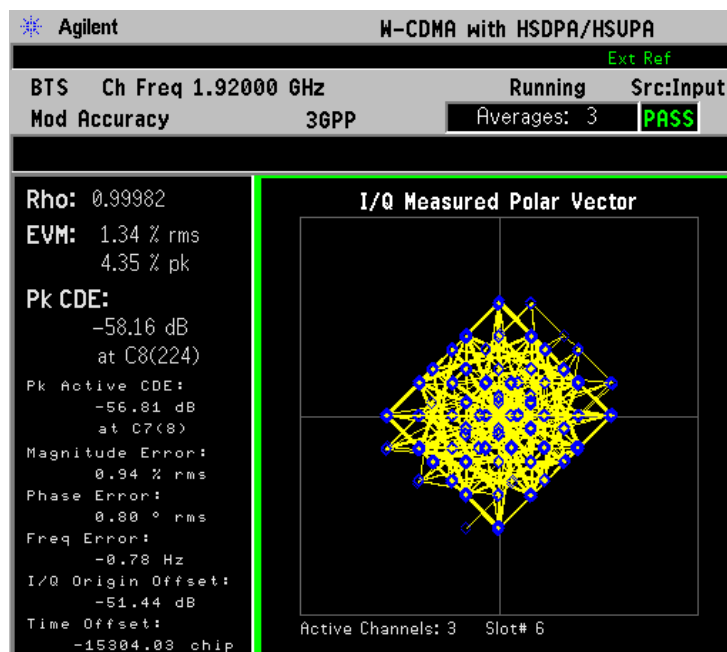
Measurement Parameter	Factory Default Condition
Sync Type	CPICH
P-Scramble Code	0
Scramble Code Offset	0
Scramble Code Type	Std (standard)
Symbol Boundary	Auto
SCH Include (Full Slot)	On
Spectrum	Normal
Advanced	
EVM Result I/Q Offset	Std.
Active Set Th(reshold)	Auto
Filter Alpha	0.220
Chip Rate	3.84000 MHz
ADC Range	-6 dB (12-bit ADC for VSA) None (14-bit ADC for VSA and PSA)
PICH Code Number	16
MICH Code Number	Off
Multi Channel Estimator	Off
Timing Estimation	Global

View/Trace Key Menu

Key Path: View/Trace

- **I/Q Measured Polar Graph** - Provides a combination view of an I/Q measured polar vector graph and the summary data (shown in Figure 3-18). The data points displayed in the constellation diagram are the measured data within the slot specified by the Measurement Offset setting, and are not averaged data. The data summary shows the calculated results based on the displayed data.

Figure 3-18 Modulation Accuracy Measurement - I/Q Measured Polar Graph



*Meas Setup: Trig Source = Frame,
Others = Factory default settings

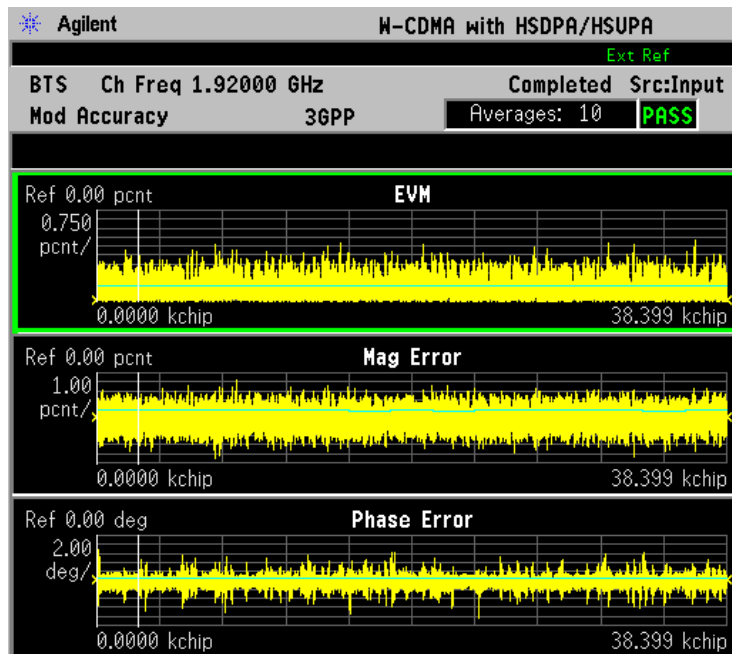
*Input signals: -10.00 dBm, PCCPCH + SCH + 1 DPCH

Key Reference
W-CDMA Measurement Keys

- **I/Q Error** - Provides a combination view of EVM, magnitude error, and phase error graphs (as shown in [Figure 3-19](#)).

The measured part of the captured signal is shown as a gate between two vertical white lines. If **Meas Offset** is employed, the gate is displayed offset from the beginning of the captured signal.

Figure 3-19 Modulation Accuracy Measurement - I/Q Error (Tri-View)



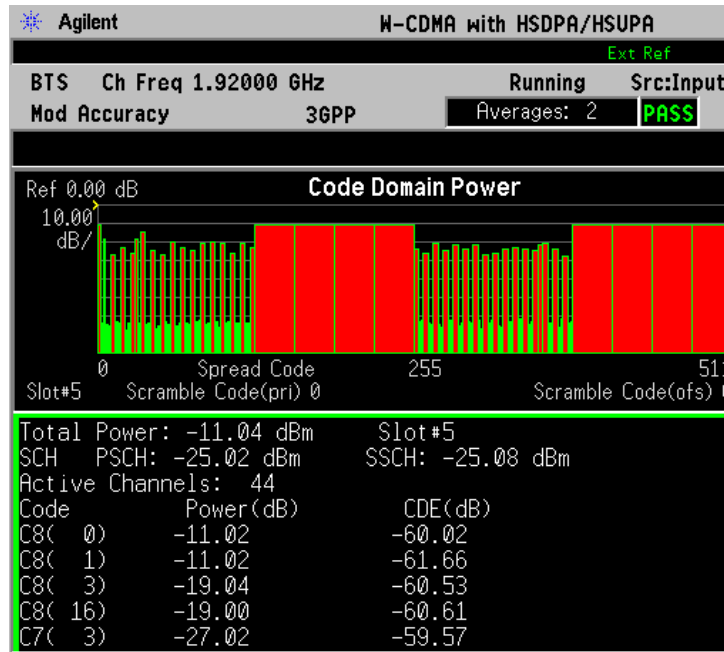
*Meas Setup: View/Trace = I/Q Error (Tri-View),
Trig Source = RF Burst,
Others = Factory default settings

*Input signals: -30.00 dBm, PCCPCH + SCH + 1 DPCH

Any one of these windows can be selected by the **Next Window** key and made full size by the **Zoom** key.

- **Code Domain Power** - Provides a graph of individual code domain channels power relative to the carrier power.. A table of summary data for the active code channels is provided in the text window (as shown in [Figure 3-20](#)).

Figure 3-20 Modulation Accuracy Measurement - Code Domain Power



*Meas Setup: View/Trace = Code Domain View,
Trig Source = Frame,
Others = Factory default settings

*Input signal: -20.00 dBm, Test Model 5 w/ 8 HS-PDSCH

Any one of these windows can be selected by the **Next Window** key and made full size by the **Zoom** key.

Key Reference
W-CDMA Measurement Keys

- **Peak/Average Metrics** - Provides a table of magnitude error, phase error, EVM, and the modulation accuracy summary data including rho, peak and rms EVM, Peak Modulation Accuracy (Rho) error, peak code domain error, magnitude error, and phase error in a text window (as shown [Figure 3-21](#)).

Figure 3-21 Mod Accuracy Measurement - Peak/Average Metrics View

Agilent		W-CDMA with HSDPA/HSUPA	
		Ext Ref	
BTS	Ch Freq 1.92000 GHz	Running	Src:Input
Mod Accuracy	3GPP	Averages: 7	PASS
Peak/Average Metrics			
	Average	Peak Hold	
Rho:	0.99982	0.99981	
RMS EVM:	1.34 %	1.37 %	
Peak EVM:	3.97 %	4.37 %	
Pk CDE:	-58.32 dB	-57.30 dB	at C8(1)
Pk Active CDE:	-49.06 dB	-48.54 dB	at C4(15)
RMS Mag Error:	0.94 %	0.97 %	
RMS Phase Error:	1.63 °	3.75 °	
Freq Error:	-0.01 Hz	1.77 Hz	
I/Q Origin Offset:	-54.09 dB	-51.58 dB	
Time Offset:	-12895.89 chip	-19289.09 chip	
CPICH Power :	-11.00 dB	-10.94 dB	
Total Power:	-11.07 dBm	-10.97 dBm	

*Meas Setup: View/Trace = Peak/Average Metrics
Trig Source = Free Run
Others = Factory default settings

*Input signals: -30.00 dBm, PCCPCH + SCH + 3 DPCH

Any one of these windows can be selected by the **Next Window** key and made full size by the **Zoom** key.

- **Capture Time Summary** - Provides a table of summary data for the measurement results over the entire Capture Interval in a text window. The peak or worst results are highlighted (as shown [Figure 3-22](#)).

Figure 3-22 Mod Accuracy Measurement - Capture Time Summary

Agilent		W-CDMA with HSDPA/HSUPA				
		Ext Ref				
BTS	Ch Freq	1.92000 GHz	Completed		Src:Input	
Mod Accuracy	3GPP	Averages: 0		PASS		
Slot#	EVM (%)	PkCDE (dB)	at	Freq Err (Hz)	CPICH (dB)	Total Pwr (dBm)
5	1.342	-58.25	C8(144)	-0.052	-11.02	-11.04
6	1.336	-58.03	C8(99)	0.536	-11.02	-11.05
7	1.345	-58.58	C8(249)	-0.507	-10.94	-11.15
8	1.360	-57.72	C8(1)	0.153	-11.07	-11.00
9	1.333	-58.73	C8(8)	-0.212	-11.03	-11.05
10	1.304	-58.26	C8(178)	-0.005	-10.96	-11.13
11	1.338	-58.12	C8(130)	-0.281	-10.94	-11.13
12	1.339	-58.90	C8(174)	-0.111	-11.09	-10.98
13	1.317	-58.01	C8(141)	-0.241	-10.95	-11.12
14	1.359	-58.14	C8(51)	0.503	-11.02	-11.06
0	1.326	-58.39	C8(128)	-0.216	-10.98	-11.08
1	1.320	-58.52	C8(32)	0.167	-10.96	-11.10
2	1.362	-58.33	C8(142)	-0.161	-11.03	-11.03
3	1.338	-58.46	C8(188)	0.997	-10.99	-11.10
4	1.347	-58.51	C8(28)	-1.534	-10.98	-11.09
Avg	1.338	-58.33		-0.064	-11.00	-11.07

*Meas Setup: View/Trace = Capture Time Summary
Trig Source = Free Run
Others = Factory default settings

*Input signals: -10 dBm, Test Model 5 w/ 8 HS-PDSCH

Any one of these windows can be selected by the **Next Window** key and made full size by the **Zoom** key.

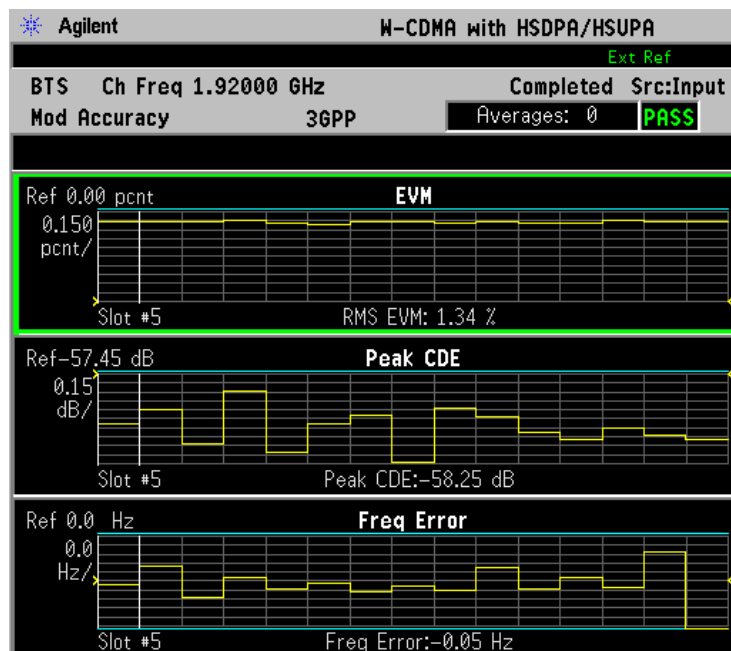
Key Reference
W-CDMA Measurement Keys

- **Slot CDE/EVM** - Provides a combination view of frequency error, peak Code Domain error, and an EVM graph for slot-by-slot results (as shown [Figure 3-23](#)).

The measured part of the captured signal is shown as a gate between two vertical white lines. If **Meas Offset** is employed, the gate is displayed offset from the beginning of the captured signal. The values displayed at the bottom center of each graph also reflect the offset setting.

Pass/Fail limits set using the **Meas Setup, Limits** menu are shown as blue horizontal lines on the graphs.

Figure 3-23 Mod Accuracy Measurement - Slot CDE/EVM View



*Meas Setup: View/Trace = Slot EVM
Trig Source = Free Run
Others = Factory default settings

*Input signals: -10 dBm, Test Model 5 w/ 8 HS-PDSCH

Display Key Menu

Key Path: **Display**

- **I/Q Polar Vec/Constln** - Allows you to specify the format of the Polar Vector graph display by providing a menu with the following selections:
 - **Vector and Constellation**
 - **Vector Only**
 - **Constellation Only**
- **Chip Offset** - Allows you to specify the number of chips offset from the first chip in a captured slot. The ranges are determined depending on the **Device** and **SCH Include** selections as shown in the table.

Conditions	Chip Offset (chips)	I/Q Chips
BTS SCH Include = On or MS	Min:0 Max: 2560 - (I/Q_chips)	Min: 1 Max: 2560
BTS SCH Include = Off	Min: 256 (SCH) Max: 2560 - (I/Q_chips)	Min: 1 Max: 2304 ^a

a. $2304 = 2560 - 256$ (SCH)

- **I/Q Chips** - Allows you to specify the number of I/Q chips displayed for the I/Q waveforms. The ranges are dependent on the **Device** and **SCH Include** selections as shown in the above table.
- **Interpolation** - Allows you to toggle the interpolation function between **On** and **Off**. If set to **On**, the solid lines between chip dots are converted to smoothed curves by the interpolation function. This is grayed out if the **I/Q Measured Polar Constln** view is selected in the **View/Trace** menu.
- **+45 deg Rot** - Allows you to toggle the display rotation function between **On** and **Off**. If set to **On**, the I/Q polar vector or I/Q polar constellation graph is rotated by +45 degrees to provide a rectangular display.
- **Full Vector (Background)** - Allows you to toggle the full vector display function between **On** and **Off**. If set to **On**, the full vector traces in gray color are displayed in the background of the polar vector solid traces in yellow. Both traces can be interpolated by the **Interpolation** key. This is grayed out if the **I/Q Measured Polar Constln** view is selected in the **View/Trace** menu.
- **Time Offset Unit** - Allows you to toggle the unit of Time Offset result between **Chip** and **Second**.

NOTE The following additional keys appear in **I/Q Error (Quad View)** view when the EVM, Phase Error, or Mag Error window is active.

- **SPAN X Scale**
 - **Scale/Div** - Allows you to set the horizontal scale by changing a chip value per division. The range is 64.0 to 38400.0 chips per division with 0.001 chip resolution. The default setting is 255.9 chips per division. When the **Scale Coupling** default setting **On** is in effect, displayed plots use a Scale/Div value determined by the analyzer, based on the measurement result.
 - **Ref Value** - Allows you to set the chip reference value ranging from 0.000 to 5000000.0 chips. The default setting is 0.000 chip. When the **Scale Coupling** default setting **On** is in effect, displayed plots use a Scale/Div value determined by the analyzer, based on the measurement result.
 - **Ref Position** - Allows you to set the reference position to either **Left**, **Ctr** (center) or **Right**. The default setting is **Left**.
 - **Scale Coupling** - Allows you to toggle the scale coupling function between **On** and **Off**. The default setting is **On**. Upon pressing the **Restart** front panel key or **Restart** softkey under the **Meas Control** menu, this function automatically determines the scale per division and reference values based on the measurement results.

NOTE The following additional keys appear in **I/Q Error (Quad View)** view when the EVM or Mag Error window is active.

- **AMPLITUDE Y Scale**
 - **Scale/Div** - Allows you to set the vertical scale by changing the value per division. The range is 0.100 to 50.0% per division. The default setting is 5.00%. When the **Scale Coupling** default setting **On** is in effect, displayed plots use a Scale/Div value determined by the analyzer, based on the measurement result.
 - **Ref Value** - Allows you to set the reference value ranging from -500.0 to 500.0%. The default setting is 0.00%. When the **Scale Coupling** default setting **On** is in effect, displayed plots use a Scale/Div value determined by the analyzer, based on the measurement result.
 - **Ref Position** - Allows you to set the reference position to either **Top**, **Ctr** (center) or **Bot** (bottom). For the EVM graph, the default setting is **Bot**. For the Mag Error graph, the default setting is **Ctr**.

- **Scale Coupling** - Allows you to toggle the scale coupling function between **On** and **Off**. The default setting is **On**. Upon pressing the **Restart** front panel key or **Restart** softkey under the **Meas Control** menu, this function automatically determines the scale per division and reference values based on the measurement results.

NOTE

The following additional keys appear in **I/Q Error (Quad View)** view when the Phase Error window is active.

- **AMPLITUDE Y Scale**

- **Scale/Div** - Allows you to set the vertical scale by changing the value per division. The range is 0.01 to 3600 degrees. The default setting is 5.00 degrees per division. When the **Scale Coupling** default setting **On** is in effect, displayed plots use a Scale/Div value determined by the analyzer, based on the measurement result.
- **Ref Value** - Allows you to set the reference value ranging from -36000 to 36000 degrees. The default setting is 0.00 degrees. When the **Scale Coupling** default setting **On** is in effect, displayed plots use a Scale/Div value determined by the analyzer, based on the measurement result.
- **Ref Position** - Allows you to set the reference position to either **Top**, **Ctr** (center) or **Bot** (bottom). The default setting is **Ctr**.
- **Scale Coupling** - Allows you to toggle the scale coupling function between **On** and **Off**. The default setting is **On**. Upon pressing the **Restart** front panel key or **Restart** softkey under the **Meas Control** menu, this function automatically determines the scale per division and reference values based on the measurement results.

Marker Key Menu

Key Path: **Marker**

- **Marker**
 - **Select** - Allows you to activate up to four markers with the corresponding numbers, respectively. The selected number is underlined and its function is defined by pressing the **Function** key. The default setting is 1.
 - **Normal** - Allows you to activate the selected marker to read the magnitude or phase error and the number of chips of the marker position on the selected trace. Marker position is controlled by the RPG knob.
 - **Delta** - Allows you to read the differences in the magnitude or phase errors and the number of chips between the selected marker and the next.
 - **Function** - Allows you to set the selected marker function to **Band Power**, **Noise**, or **Off**. The default setting is **Off**. The **Band Power** and **Noise** functions are not available for this measurement.
 - **Trace** - Allows you to place the selected marker on various traces including: **EVM (in chip)**, **Phase Error**, **Mag Error**, and **Code Domain Power**. The default setting is **EVM (in chip)**.
 - **Off** - Allows you to turn off the selected marker.
 - **Shape** - Allows you to access the menu to set the selected marker shape to **Diamond**, **Line**, **Square**, or **Cross**. The default setting is **Diamond**.
 - **Marker All Off** - Allows you to turn off all of the markers.

Multi Carrier Power Keys

NOTE

You must have selected **Multi Carrier Power** under the **MEASURE** key to access the following menus.

Meas Setup Key Menu

Key Path: Multi Carrier Power, **Meas Setup**

- **2nd Carrier Offset** - Allows you to access the following menu to select one of the offset frequency values for the second carrier to be measured:
 - **+15MHz** - Select this to set the second carrier offset frequency to +15.0 MHz from the center carrier frequency.
 - **+10MHz** - Select this to set the second carrier offset frequency to +10.0 MHz from the center carrier frequency.
 - **+5MHz** - Select this to set the second carrier offset frequency to +5.0 MHz from the center carrier frequency.
 - **-5MHz** - Select this to set the second carrier offset frequency to -5.0 MHz from the center carrier frequency.
 - **-10MHz** - Select this to set the second carrier offset frequency to -10.0 MHz from the center carrier frequency.
 - **-15MHz** - Select this to set the second carrier offset frequency to -15.0 MHz from the center carrier frequency.
- **Ref Chan** - Allows you to access the following menu to select one of the reference channel levels:
 - **Auto** - Select this to set the reference channel level to the highest carrier power level in two carriers to make relative power measurements. **Auto (Lower)** is shown in the text window if the lower frequency carrier power is equal to or larger than the upper frequency carrier power. **Auto (Upper)** is shown if the upper frequency carrier power is larger than the lower frequency carrier power.
 - **Lower** - Select this to set the reference channel level to the lower frequency carrier power to make relative power measurements.
 - **Upper** - Select this to set the reference channel level to the upper frequency carrier power to make relative power measurements.
 - **Average** - Select this to set the reference channel level to the average power level of two carriers to make relative power measurements.
- **Meas Mode** - Allows you to access the following menu to select one of the measurement modes:

Key Reference
W-CDMA Measurement Keys

- **All Channels** - Select this to measure the power levels of all offset channels including the offset channels between two carrier channels depending on the selection of **2nd Carrier Offset**, along with two carrier levels.
- **3rd IM Only** - Select this to measure the third-order intermodulation product levels depending on the selection of **2nd Carrier Offset**, along with two carrier levels.
- **3rd/5th/7th IM** - Select this to measure the third-, fifth-, and seventh-order intermodulation product levels depending on the selection of **2nd Carrier Offset**, along with two carrier levels.
- **Ofs & Limits** - Allows you to access the menu to change the following parameters and pass/fail tests for each offset. If one limit test fails, the red character F is shown on the right side of the measured value and the corresponding bar changes its color to red.
 - **Offset** - Allows you to access the memory selection menu from **A** to **D** to store 4 sets of test conditions. Frequencies are automatically specified according to the selection of the second carrier offset. Only one selection at a time (A, B, C, or D) is shown on this key.
 - **Abs Limit** - Allows you to enter an absolute limit value ranging from -200.00 to $+50.00$ dBm with 0.01 dB resolution.
 - **Fail** - Allows you to access the following menu to select one of the logic keys for fail conditions between the measurement results and the test limits:
 - AND** - Fail is shown if one of the absolute power measurement results is larger than the limit for **Abs Limit** AND one of the relative power measurement results is larger than the limit for **Rel Lim (Car)**.
 - OR** - Fail is shown if one of the absolute power measurement results is larger than the limit for **Abs Limit** OR one of the relative power measurement results is larger than the limit for **Rel Lim (Car)**.
 - Absolute** - Fail is shown if one of the absolute power measurement results is larger than the limit for **Abs Limit**.
 - Relative** - Fail is shown if one of the relative power measurement results is larger than the limit for **Rel Lim (Car)**.
 - **Rel Lim (Car)** - Allows you to enter a relative limit value of the carrier level ranging from -200.00 to $+50.00$ dBc with 0.01 dB resolution.

- **Restore Meas Defaults** - Allows you to preset only the settings that are specific to the selected measurement by pressing **Meas Setup, More (1 of 2), Restore Meas Defaults**. This will set the measure setup parameters, for the currently selected measurement only, to the factory defaults.
- **Advanced** - Allows you to access the following menu:

NOTE

Parameters under the **Advanced** key seldom need to be changed. Any changes from the factory default values may result in invalid measurement data.

- **RRC Filter** - Allows you to toggle the root raised cosine filter function between **On** and **Off**.
- **Alpha** - Allows you to set the roll-off factor (alpha value) of RRC Filter. The range is 0.010 to 0.500.

Table 3-10 shows the factory default settings for multi carrier power measurements.

Table 3-10

Multi Carrier Power Measurement Defaults

Measurement Parameter	Factory Default Condition
Meas Setup:	
Avg Number	10; On
Avg Mode	Repeat
2nd Carrier Offset	+5 MHz
Ref Chan	Lower or Upper; Auto
Meas Mode	All Channels
Ofs & Limits:	
Offset	A
Abs Limit	50.00 dBm
Fail	Relative
Rel Lim (Car)	0.00 dBc
Advanced	
RRC Filter	On
Alpha	0.220

View/Trace Key Menu

The **View/Trace** key is not available for this measurement.

Display Key Menu

Key Path: **Display**

- **Bar Colors** - Allows you to access the menu to change the bar color of each bar in the graph:
 - **Center Car** - Allows you to access the color selection menu from **White** to **Green** for the center carrier bar. The default selection is **Yellow** as shown on this key. The following color menu is available for the center carrier, second carrier, and all of the offset channel bars:
 - White**
 - Medium Gray**
 - Blue**
 - Sky Blue**
 - Purple**
 - Yellow**
 - Green**
 - **Second Car** - Allows you to access the color selection menu from **White** to **Green** for the second carrier bar. The default selection is **Yellow** as shown on this key.
 - **-5 MHz Ofs Ch** - Allows you to access the color selection menu from **White** to **Green** for the -5 MHz offset channel bar. The default selection is **Sky Blue** as shown on this key.
 - **+5 MHz Ofs Ch** - Allows you to access the color selection menu from **White** to **Green** for the +5 MHz offset channel bar. The default selection is **Green** as shown on this key.
 - **+10 MHz Ofs Ch** - Allows you to access the color selection menu from **White** to **Green** for the +10 MHz offset channel bar. The default selection is **Green** as shown on this key.
 - **+15 MHz Ofs Ch** - Allows you to access the color selection menu from **White** to **Green** for the +15 MHz offset channel bar. The default selection is **Green** as shown on this key.

Marker Key Menu

The **Marker** key is not available for this measurement.

Occupied BW Keys

NOTE

You must have selected **Occupied BW** under the **MEASURE** key to access the following menus.

Meas Setup Key Menu

Key Path: **Occupied BW, Meas Setup**

- **Span** - Allows you to specify the frequency span in which the total power is measured. The range is 10.000 kHz to 10.0000 MHz with 0.1 kHz resolution.
- **Res BW** - Allows you to specify the resolution bandwidth value. The frequency range is 1.000 kHz to 1.00000 MHz. A narrower bandwidth will result in a longer data acquisition time but you will be able to examine the signal more closely.
- **Limit Test** - Allows you to toggle the limit test function between **On** and **Off**, for occupied bandwidth measurements.
- **Limit** - Allows you to specify the limit frequency value with which the limit test is made. The range is 10.000 kHz to 10.0000 MHz with 100 Hz resolution.
- **Restore Meas Defaults** - Allows you to preset only the settings that are specific to the selected measurement by pressing **Meas Setup, More (1 of 2), Restore Meas Defaults**. This will set the measure setup parameters, for the currently selected measurement only, to the factory defaults.
- **Advanced** - Allows you to access the selection menu of FFT windows.
 - **FFT Window** - Allows you to access the following selection menu for FFT windows. If you are familiar with FFT windows, you can use other digital filters but the use of the flat top filter is recommended. Changes from the default setting may result in invalid data.
 - Flat Top** - Select this filter for best amplitude accuracy by reducing scalloping error.
 - Uniform** - Select this filter to have no active window.
 - Hanning** - Press this key to activate the Hanning filter.
 - Hamming** - Press this key to activate the Hamming filter.
 - Gaussian (Alpha 3.5)** - Press this key to activate the Gaussian filter with an alpha of 3.5.
 - Blackman** - Press this key to activate the Blackman filter.
 - Blackman-Harris** - Press this key to activate the Blackman-Harris filter.
 - K-B 70dB/90dB/110dB (Kaiser-Bessel)** - Allows you to select one of the Kaiser-Bessel filters with sidelobes at -70, -90, or -110 dB.

Table 3-11 shows the factory default settings for occupied bandwidth measurements.

Table 3-11 Occupied Bandwidth Measurement Defaults

Measurement Parameter	Factory Default Condition
Meas Setup:	
Avg Number	10; On
Avg Mode	Repeat
Span	10.0000 MHz
Res BW	30.000 kHz
Trig Source	Free Run (Immediate)
Limit Test	On
Limit	5.00000 MHz
Advanced	
FFT Window	Gaussian (Alpha 3.5)

View/Trace Key Menu

The **View/Trace** key is not available for this measurement.

Display Key Menu

Key Path: **Display**

- **AMPLITUDE Y Scale**

- **Scale/Div** - Allows you to enter a numeric value to change the vertical display sensitivity. The range is 0.10 to 20.00 dB with 0.01 dB resolution. The default setting is 10.00 dB. When the **Scale Coupling** default setting **On** is in effect, displayed plots use a Scale/Div value determined by the analyzer, based on the measurement result.
- **Ref Value** - Allows you to set the absolute power reference value ranging from -250.00 to 250.00 dBm with 0.01 dB resolution. The default setting is 10.00 dBm. When the **Scale Coupling** default setting **On** is in effect, displayed plots use a Scale/Div value determined by the analyzer, based on the measurement result.
- **Ref Position** - Allows you to set the reference position to either **Top**, **Ctr** (center), or **Bot** (bottom). The default setting is **Top**.
- **Scale Coupling** - Allows you to toggle the scale coupling function between **On** and **Off**. The default setting is **On**. Upon pressing the **Restart** front panel key or the **Restart** softkey under the **Meas Control** menu, this function automatically determines the scale per division and reference values based on the measurement results.

Marker Key Menu

The **Marker** key is not available for this measurement function.

Power Stat CCDF Keys

NOTE You must have selected **Power Stat CCDF** under the **MEASURE** key to access the following menus.

Meas Setup Key Menu

Key Path: Power Stat CCDF, **Meas Setup**

- **Meas BW** - Allows you to set the measurement bandwidth according to the channel bandwidth. The range is 10.000 kHz to 6.70000 MHz with 0.1 kHz resolution.
- **Counts** - Allows you to set the accumulated number of sampling points for data acquisition. The range is 1.000 kpt (k point) to 2.00000 Gpt (G point) with 1 kpt resolution. While this key is activated, enter a value from the numeric keypad by terminating with one of the unit keys shown.
- **Meas Interval** - Allows you to specify the time interval over which the measurement is made. The range is 100.0 μ s to 10.00 ms with 1 μ s resolution.
- **Trig Source** - Allows you to select one of the trigger sources: **Free Run (Immediate)**, **Video (IF Envlp)**, **RF Burst (Wideband)**, **Ext Front**, **Ext Rear**, or **Frame**. The default setting is **Free Run (Immediate)**.
- **Restore Meas Defaults** - Allows you to preset only the settings that are specific to the selected measurement by pressing **Meas Setup**, **More (1 of 2)**, **Restore Meas Defaults**. This will set the measure setup parameters, for the currently selected measurement only, to the factory defaults.

Table 3-12 shows the factory default settings for power statistics CCDF measurements.

Table 3-12 Power Statistics CCDF Measurement Defaults

Measurement Parameter	Factory Default Condition
Meas Setup:	
Meas BW	5.00000 MHz
Counts	10.0000 Mpt
Meas Interval	1.000 ms
Trig Source	Free Run (Immediate)
Meas Control:	
Measure	Single
Display:	
Ref Trace	Off
Gaussian Line	On

View/Trace Key Menu

The **View/Trace** key is not available for this measurement.

Display Key Menu

Key Path: **Display**

- **Store Ref Trace** - Allows you to copy the currently measured curve as the user-definable reference trace. The captured data will remain until the other mode is chosen. Pressing this key refreshes the reference trace.
- **Ref Trace** - Allows you to toggle the reference trace display function between **On** and **Off**.
- **Gaussian Line** - Allows you to toggle the Gaussian line display function between **On** and **Off**.
- **SPAN X-Scale**
 - **Scale/Div** - Allows you to enter a numeric value to change the horizontal display sensitivity. The range is 0.10 to 20.00 dB with 0.01 dB resolution. The default setting is 2.00 dB.

Marker Key Menu

Key Path: **Marker**

- **Select** - Allows you to activate up to four markers with the corresponding numbers, respectively. The selected number is underlined and its function is defined by pressing the **Function** key. The default selection is 1.
- **Normal** - Allows you to activate the selected marker to read the power level and probability of the marker position on the selected curve. Marker position is controlled by the RPG knob.
- **Delta** - Allows you to read the differences in the power levels and probabilities between the selected marker and the next.
- **Function** - Allows you to set the selected marker function to **Band Power**, **Noise**, or **Off**. The default setting is **Off**. The **Band Power** and **Noise** functions are not available for this measurement.
- **Trace** - Allows you to place the selected marker on the **Measured**, **Gaussian**, or **Reference** curve. The default setting is **Measured**.
- **Off** - Allows you to turn off the selected marker.
- **Shape** - Allows you to access the menu to set the selected marker shape to **Diamond**, **Line**, **Square**, or **Cross**. The default setting is **Diamond**.
- **Marker All Off** - Allows you to turn off all of the markers.

Pwr Control Keys

NOTE

You must have selected **MS** under the **Mode Setup, Radio** and select **Pwr Control** under the **MEASURE** key to access the following menus.

Meas Setup Key Menu

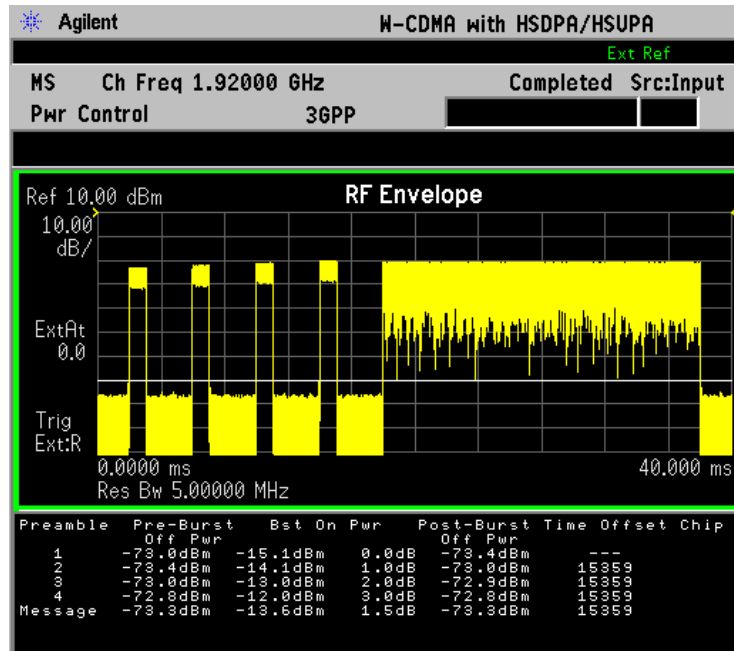
Key Path: **Pwr Control, Meas Setup**

- **Meas Type** - Allows you to select the uplink power measurement type, and the power computation method is set accordingly. The appropriate synchronization type is selected automatically.
 - **Slot** - The Slot power measurement measures total power across the whole slot. The synchronization type is set to DPCCH for the slot power measurement automatically. When **Slot** is selected, the **Slot Power Meas** setup key is available, see below.
 - **PRACH** - The PRACH power measurement measures the power contained in the uplink PRACH preamble. The synchronization type is set to PRACH preamble for the PRACH power measurement automatically. When **PRACH** is selected, the **PRACH Power Meas** setup key is available, see below.
 - **Slot Phase** - The Slot Phase measurement can determine the phase discontinuity of UE between two adjacent timeslots. Slot Phase measures the phase error, frequency error, and EVM of uplink slots in addition to their slot power. The Slot Phase measurement is synchronized to the clock timing of the radio system, as determined by re-sampling the signal. There is no **PASS/FAIL** indication for this measurement. When **Slot Phase** is selected, the **Slot Phase Meas** setup key is available, see below.
 - **Sync Start Slot** - Allows you to specify one of the slots as the first slot to measure. Used for the power control measurement when **Meas Method** is set to **Chip Power**. The range is 0 to 5. The default is 0.
- **Meas Method**- When **Meas Method** is set to **Waveform**, the measurement aligns the slot boundary with the appropriate offset chips because the chip re-sampling process is not made on the captured data. When **Meas Method** is set to **Chip Power**, the chip re-sampling process works to use the desired part of acquisition data in the first slot boundary.

Key Reference
W-CDMA Measurement Keys

- **Slot Power Meas** - When **Meas Type** is set to **Slot**, this key allows you to access the menu of the following parameters to make the slot-based power calculation for the waveform or chip power measurement result when **Meas Type** is set to **Slot**.
 - **Slot Format** - Allows you to enter an integer from SF0 to SF5, or to select **Auto** as one of the slot formats to be used for the power control measurement when **Meas Type** is set to **Slot Phase**. The range is SF0 to SF5. The default is SF0.
 - **Slot Offset** - Specifies the number of chips to be offset from the first acquisition data to the slot boundary. The range is 0.0 chips to 5120.0 chips. The default is 0.0 chips.
 - **Meas Delay** - Specifies the number of chips to be delayed from the slot boundary to the start point of power measurement. The range is 0.0 chips to (**PCG Length** – **Meas Intvl**) chips. The default is 96.0 chips which is equivalent to 25 μ s at the 3.840 MHz chip rate.
 - **Meas Intvl** - Specifies the number of chips to be used as the measuring interval for the averaged rms power measurement. The range is 1.0 chips to (**PCG Length** – **Meas Delay**) chips. The default is 2368.0 (= 2560.0 – 96.0 \times 2) chips.
 - **PCG Length** - Specifies the number of chips to be used as the integration time for the slot power measurement. Minimum value of this setting is larger value of 768.0 chips and (PDG Length + Meas Delay). Maximum vlaue is 2560.0 chips. The default is 2560.0 chips.
- **PRACH Power Meas** - When **Meas Type** is set to **PRACH Power Meas**, this key allows you to access menu to make a PRACH power profile measurement of the waveform or chip power. [Figure 3-24](#) shows the power control measurement result for the PRACH power type.

Figure 3-24 Power Control Measurement Result - PRACH Power Type



- **Preamble Length** - Specifies the number of chips to be used as the length for PRACH preamble power-on period. The range is 4000.0 chips to 4200.0 chips. The default is 4096.0 chips.
- **Message Length** - Specifies the time value to be used as the length for PRACH message burst-on period. The choices are 10 ms and 20 ms. The default is 10 ms.
- **Meas Offset** - Specifies the number of chips to be used as the transient periods at the burst ramp-up and ramp-down that are excluded to make the power measurement. The range is 0.0 chips to 200.0 chips. The default is 96.0 chips which is equivalent to 25 μ s at the 3.840 MHz chip rate.
- **Off Power Intvl** - Specifies the number of chips to be used as the length for power-off measurement interval. The range is 1.0 chips to 12800.0 chips. The default is 2368.0 chips
- **Slot Phase** - When **Meas Type** is set to **Slot Phase**, this key allows you to access the menu to measure phase error, frequency error, and EVM uplink slots in addition to their slot power.
- **Meas Method** - Allows you to toggle the power measurement method between **Chip Power** and **Waveform**.

Key Reference
W-CDMA Measurement Keys

- **RRC Filter** - Allows you to toggle the root-raised cosine filter function between **On** and **Off**. The default is **Off**.
- **Capture Intvl** - Allows you to menu of the following selections to specify the number of frames for data acquisition.
 - **1 frame** - Specifies one frame to be used for capturing data.
 - **2 frames** - Specifies two frames to be used for capturing data.
 - **4 frames** - Specifies four frames to be used for capturing data.
 - **8 frames** - Specifies eight frames to be used for capturing data.
- **Slot Format** - Allows you to enter an integer from SF0 to SF5, or to select **Auto** for the power control measurement when **Meas Method** is set to **Chip Power**. The range is SF0 to SF5. The default is SF0.
- **PRACH Preamble** - Allows you to access the menu of the following parameters to select the synchronization signature pattern. **Auto** or **Preamble** to which one of the signature patterns needs to be set for synchronization. The range of signature patterns is 0 to 15. The default is **Auto**.
 - **Auto** - One of the signature patterns, 0 to 15, is automatically specified to synchronize with.
 - **Preamble** - Specifies one of the signature patterns to which the synchronization is made. The range is 1 to 15. The default is 0.
- **Scramble Code** - Allows you to set the scramble code using a set of hexadecimal digits, **A** through **E**. Press **Done** when the code is completely specified.
- **Symbol Boundary** - Allows you to access the following menu to choose a symbol boundary detection mode, which specifies how active channels are detected.
 - **Auto** - Various code channels are examined and appropriate code channels are detected as active channels. The **Auto** measurement algorithm makes the assumption that active channels may vary slot-by-slot over the entire capture interval. Even if channels are being transmitted as bursts, good results will be obtained using the **AUTO** setting.
 - **Custom** - Select this to set the symbol boundary detection to specific active channels. .

NOTE

If the Power graph window is active in the **Power Graph & Metrics** view, **Code Domain (Quad View)**, or **Demod Bits** view, it uses only the spreading rate defined by the **Symbol Rate** key under the **Display** menu. (The **Composite** key under the **Display** menu is set to Off.) The width of each bar changes according to the symbol rate setting.

- **Restore Meas Defaults** - Allows you to preset only the settings that are specific to the selected measurement by pressing **Meas Setup, More (1 of 2), Restore Meas Defaults**. This will set the measure setup parameters, for the currently selected measurement only, to the factory defaults.
- **Advanced** - Allows you to access the menu of the following parameters to modify the power control measurement condition:

NOTE

Parameters under the **Advanced** key seldom need to be changed. Any changes from the factory default values may result in invalid measurement data.

- **RBW Filter** - Allows you to toggle the filter shapes between **Gaussian** and **Flat** (flattop). The default is **Flat**.
- **Res BW** - Allows you to specify the resolution bandwidth for power control measurements. The range is 100.000 kHz to 10.000 MHz. The default is 5.000 MHz.
- **Alpha** - Allows you to specify the alpha value of the root-raised cosine filter. The range is 0.01 to 0.50. The default is 0.220.
- **Chip Rate** - Allows you to specify the chip rate to be used for power control measurements. The range is 3.456 MHz to 4.224 MHz with 0.01 Hz resolution. The default is 3.840 MHz.
- **PRACH Noise Floor** - Allows you optimize your measurement by specifying the noise floor of the signal to be used for power control measurements. Sensitivity of PRACH preamble detection is enhanced by correctly setting the noise floor level. The range is -156.0 dBm to -36.0 dBm, with a -69.0 dBm default setting.
- **PRACH Threshold** - This is a read-only key indicating the PRACH threshold level. The PRACH threshold level is determined by the the **PRACH Noise Floor** setting. The PRACH Threshold level is also shown as a white horizontal line on the RF Envelope display (see [Figure 3-24 on page 291](#)).
- **ADC Range** - This provides you the ability to select a ranging function for the ADC gain control. Available only when **Meas Type** is set to **Slot Phase**.

Table 3-13 shows the factory default settings for power control measurements.

Table 3-13 Power Control Measurement Defaults

Measurement Parameter	Factory Default Condition
Slot Power Meas	
Slot Format	SF0
Sync Start Slt	Off
Slot Offset	0.0 chips
Meas Delay	96.0 chips
Meas Intvl	2368.0 chips
PCG Length	2560.0 chips
PRACH Power Meas	
Preamble Length	4096.0 chips
Message Length	20.0 ms
Meas Offset	96.0 chips
Off Power Intvl	2368 chips
Slot Phase	Power Graph & Metrics
Meas Method	Waveform
RRC Filter	Off
Capture Intvl	4 frames
Meas Type	Slot Power
Scramble Code	0
Slot Format	0
PRACH Preamble	Auto
Trig Source	Free Run (Immediate)
Advanced	
RBW Filter	Flat
Res BW	5.000 MHz
Alpha	0.220
Chip Rate	3.840000 MHz
ADC Range	-6 dB (12-bit ADC for VSA) None (14-bit ADC for VSA and PSA)

Table 3-13 Power Control Measurement Defaults

Measurement Parameter	Factory Default Condition
PRACH Noise Floor	-69.0 dBm

View/Trace Key Menu

Key Path: **View/Trace**

- When Slot Phase is selected as the the Meas Type, the following menu is available:
 - **Power Graph and Metrics** - Provides a view of the RF Envelope in parameters of Power vs. Time in log scale.
 - **Phase Graph and Metrics** - Provides a graph of Phase Error vs. Time in log scale.
- When Slot Power or PRACH Power are selected as the the Meas Type, no selections are available.

Display Key Menu

Key Path: **Display**

- **Prev Page** - Returns one page back to the previous page of the measurement results.
- **Next Page** - Moves one page forward to the next page of the measurement results.
- **Scroll Up** - Moves one line upward from the current page of the measurement results by each pressing.
- **Scroll Down** - Moves one line downward from the current page of the measurement results by each pressing.
- **First Page** - Moves from the current page to the first page of the measurement results.
- **Last Page** - Moves from the current page to the last page of the measurement results.
- **Slot Number** - If **Meas Type** is set to **Slot Phase** the following menu is available:
 - **Rel** - Measurement results are shown with the Slot column number relative to the beginning of the captured data. For Rel displays, slot numbers always begin with 1.
 - **Abs** - Measurement results are shown with the Slot column determined by the Scramble Code number. For Abs slots, slot numbers range from 0 to 14.

- **Chip Phase On/Off**- Allows you activate or deactivate the chip-by-chip phase trace (shown in yellow).
- **SPAN X-Scale**
 - **Scale/Div** - Allows you to enter a time value to change the horizontal scale. The range is 1.0 ns to 1.000 s per division with 0.01 ns resolution. The default setting is 3.000 ms, however, since the **Scale Coupling** is defaulted to **On**, this value is automatically determined by the measurement result. If you change this value manually, **Scale Coupling** automatically becomes **Off**.
 - **Ref Value** - Allows you to set the display reference value ranging from -1.00 to 10.00 s. The default setting is 0.00 s, however, since the **Scale Coupling** is defaulted to **On**, this value is automatically determined by the measurement result. If you change this value manually, **Scale Coupling** automatically becomes **Off**.
 - **Ref Position** - Allows you to set the display reference position to either **Left**, **Ctr** (center), or **Right**. The default setting is **Left**
 - **Scale Coupling** - Allows you to toggle the scale coupling function between **On** and **Off**. The default setting is **On**. Upon pressing the **Restart** front panel key or **Restart** softkey under the **Meas Control** menu, this function automatically determines the scale per division and reference values by the measurement results. If you change **Scale/Div** or **Ref Value** manually, **Scale Coupling** automatically becomes **Off**.

- **AMPLITUDE Y Scale**

When **Window** is set to **RF Envelope**, the following Amplitude Y scale menu is available:

- **Scale/Div** - Allows you to enter a numeric value to change the vertical display sensitivity. The range is 0.10 to 20.00 dB with 0.01 dB resolution. The default setting is 10.00 dB, however, since the **Scale Coupling** is defaulted to **On**, this value is automatically determined by the measurement result. If you change this value manually, **Scale Coupling** automatically becomes **Off**.
- **Ref Value** - Allows you to set the absolute power reference value ranging from -250.00 to 250.00 dBm with 0.01 dB resolution. The default setting is 10.00 dBm, however, since the **Scale Coupling** is defaulted to **On**, this value is automatically determined by the measurement result. If you change this value manually, **Scale Coupling** automatically becomes **Off**.
- **Ref Position** - Allows you to set the display reference position to either **Top**, **Ctr** (center), or **Bot** (bottom). The default setting is **Top**.
- **Scale Coupling** - Allows you to toggle the scale coupling function between **On** and **Off**. The default setting is **On**. Upon pressing the **Restart** front panel key or **Restart** softkey under the **Meas Control** menu, this function automatically determines the scale per division and reference values by the measurement results. If you change **Scale/Div** or **Ref Value** manually, **Scale Coupling** automatically becomes **Off**.

When **Window** is set to **Phase Error**, the following Amplitude Y scale menu is available:

- **Scale/Div** - Allows you to enter a numeric value to change the vertical display sensitivity. The range is 0.01 to 3600.00 degrees with 0.01 dB resolution. The default setting is 50.00 degrees, however, since the **Scale Coupling** is defaulted to **On**, this value is automatically determined by the measurement result. If you change this value manually, **Scale Coupling** automatically becomes **Off**.
- **Ref Value** - Allows you to set the absolute power reference value. The range is -36000.0 to 36000.0 degrees with 0.01 dB resolution. The default setting is 50.00 degrees, however, since the **Scale Coupling** is defaulted to **On**, this value is automatically determined by the measurement result. If you change this value manually, **Scale Coupling** automatically becomes **Off**.
- **Ref Position** - Allows you to set the display reference position to either **Top**, **Ctr** (center), or **Bot** (bottom). The default setting is **Top**.

- **Scale Coupling** - Allows you to toggle the scale coupling function between **On** and **Off**. The default setting is **On**. Upon pressing the **Restart** front panel key or **Restart** softkey under the **Meas Control** menu, this function automatically determines the scale per division and reference values by the measurement results. If you change **Scale/Div** or **Ref Value** manually, **Scale Coupling** automatically becomes **Off**.

Marker Key Menu

Key Path: **Marker**

- **Select** - Allows you to activate up to four markers with the corresponding numbers, respectively. The selected number is underlined and its function is defined by pressing the **Function** key. The default setting is 1.
- **Normal** - Allows you to activate the selected marker to read the power level and time. The marker position is controlled either by manual adjustment of the RPG knob or by direct entry of the time value via the front panel keypad.
- **Delta** - Allows you to read the differences in the power levels and time scales between the selected marker and the next.
- **Function** - Allows you to set the selected marker function to **Band Power**, **Noise**, or **Off**. The default setting is **Off**. The **Band Power** and **Noise** functions are not available for this measurement.
- **Trace** - Allows you to place the selected marker on various traces including **RF Envelope**, **Slot Power** (for the slot power measurement) **Chip Phase**, **Average Chip Phase**, and **Phase Discontinuity** traces. The default setting is **RF Envelope**.
- **Off** - Allows you to turn off the selected marker.
- **Shape** - Allows you to access the menu to set the selected marker shape to **Diamond**, **Line**, **Square**, or **Cross**. The default setting is **Diamond**.
- **Marker All Off** - Allows you to turn off all of the markers.

Power versus Time (PvT) Mask Keys

NOTE

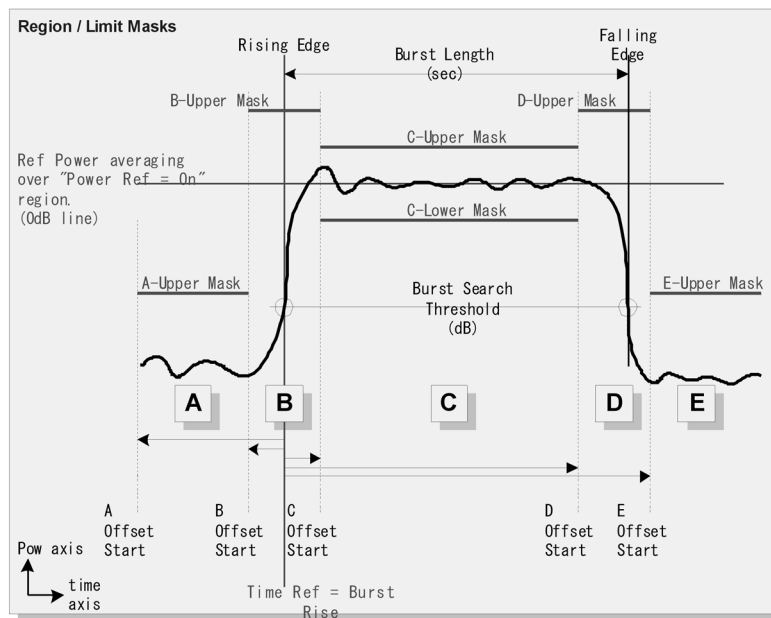
You must have selected **Pwr vs Time** under the **MEASURE** key to access the following menus.

Meas Setup Key Menu

Key Path: **Pwr vs Time, Meas Setup**

- **Avg Type** - Allows you to access the menu of the following average types:
 - **Pwr Avg (RMS)** - Executes the true power averaging which is equivalent to taking the rms of the voltage. This is the most accurate type.
 - **Maximum** - Executes the maximum voltage averaging by capturing peak data.
 - **Minimum** - Executes the minimum voltage averaging.
- **Region/Limits** - Allows you to access the menu to change the following parameters for offset time settings and power level masks. See [Figure 3-25](#), which shows the definitions of the various mask regions and limits:

Figure 3-25 Region/Limit Masks Definitions



- **Region** - Allows you to access the memory selection menu from **A** to **E** to store 5 sets of values for **Offset Start**, **Offset Stop**, **Interval**, **Upper Mask**, and **Lower Mask**, respectively. Only one memory selection at a time (A, B, C, D, or E) is shown on this key.

- **Offset Start** - Allows you to enter a time value for the offset start of a region. The range is -10.0 ms to 10.0 ms, or the acquisition start point to the acquisition end point. While this key is activated, enter an offset value from the numeric keypad by terminating with one of the unit keys shown. One offset value selected in the **Region** menu is shown on this key.
- **Offset Stop** - Allows you to enter a time value for the offset stop of a region. The range is -10.0 ms to 10.0 ms, or the offset start point to the acquisition end point. While this key is activated, enter an offset value from the numeric keypad by terminating with one of the unit keys shown. One offset value selected in the **Region** menu is shown on this key. When you set a value to **Interval**, **Offset Stop** is automatically determined based on the offset start and interval values, as **Offset Stop** and **Interval** are coupled each other.
- **Interval** - Allows you to enter an interval value between Offset Start and Offset Stop. The range is -10.0 ms to 10.0 ms. While this key is activated, enter an interval value from the numeric keypad by terminating with one of the unit keys shown.
- **Upper Mask** - Allows you to enter a relative limit value for the upper mask, and to toggle the mask function between **On** and **Off**. The range is the lower mask to $+200.00$ dB with 0.01 dB resolution.
- **Lower Mask** - Allows you to enter a relative limit value for the lower mask, and to toggle the mask function between **On** and **Off**. The range is -100.00 dB to the upper mask with 0.01 dB resolution.
- **Ref Channel** - Allows you to select Power Reference from Region A to E.
- **Time Reference** - Allows you to access the following menu to select one of the time references to make measurements:
 - **Trigger** - Allows you to set the time reference to the trigger point.
 - **Burst Rise** - Allows you to set the time reference to the rising edge of bursts.
 - **Burst Center** - Allows you to set the time reference to the center of burst length.
- **Burst Search Threshold** - Allows you to set a value of relative power level from the averaged power-on reference. This value is used to determine the rising and falling edges. The range is -100.00 to 0.00 dB.

- **Restore Meas Defaults** - Allows you to preset only the settings that are specific to the selected measurement by pressing **Meas Setup, More (1 of 2), Restore Meas Defaults**. This will set the measure setup parameters, for the currently selected measurement only, to the factory defaults.
- **Advanced** - Allows you to access the menu to set the following parameters:
 - **RBW Filter** - Allows you to toggle the filter shapes between **Gaussian** and **Flat**.
 - **Res BW** - Allows you to enter a frequency value for the filter resolution bandwidth. The range is 1.000 kHz to 8.000 MHz.
 - **RRC Filter** - Allows you to toggle the root-raised cosine (RRC) filter function between **On** and **Off**.
 - **Alpha** - Allows you to change the alpha value of the RRC filter. The range is 0.010 to 0.5000 with 0.001 resolution.
 - **Chip Rate** - Allows you to change the chip rate. The range is 3.45600 to 4.22400 MHz.
 - **Time Ref Offset** - Allows you to enter a value for the mask timing reference offset. This value is used to make a fine adjustment of timing from the time reference identified. The range is from -10.0 ms to +10.00 ms.

Table 3-14 shows the factory default settings for power versus time measurements.

Table 3-14 Power versus Time Measurement Defaults

Measurement Parameter	Factory Default Condition
View/Trace	Burst
Display Limit Mask	On
Avg Bursts	40
Avg Mode	Repeat
Avg Type	Pwr Avg (RMS)
Offset/Limits:	
Offset Offset Freq Offset Side Ref BW Avg Type	A 750.000 kHz; On (offset A) Both 30.000 kHz Pwr Avg (RMS)
Limit Setup:	
Abs Limit Fail Rel Lim (Car) Rel Lim (PSD) Trig Source Region/Limits: Region Upper Mask Lower Mask Offset Start Offset Stop Interval Power Reference	0.00 dBm Relative -45.00 dBc (offset A) -28.87 dB (offset A) RF Burst (Wideband) A A: -40.00 dB; On A: -100.00 dB; Off A: -667.0 μ s A: -25.0 μ s A: 642.0 μ s Region C
Time Reference	Burst Rise
Trig Source	Burst (wideband)
Trigger Source	RF burst (inbound)
Limit Test	On
Reference BW	18 kHz
Offset frequency	25.000 kHz
Offset bandwidth	10.000 kHz

Table 3-14 Power versus Time Measurement Defaults

Measurement Parameter	Factory Default Condition
Absolute limit	0.00 dBm
Fail	Relative
Relative limit (carrier)	-60 dB
Relative limit (PSD)	-57.45 dB
Burst Search Threshold	-45.00 dB
Ref Chan Adv:	
Sweep Time Data Points Res BW Num FFT Seg	546.1 μ s; Auto 2048; Auto 1.620 kHz (grayed out) 1; Auto
Offset Adv:	
Sweep Time Data Points Res BW Num FFT Seg Relative Atten	11.20 ms; Auto 1024; Auto 79.0 Hz (grayed out) 1; Auto 0.00 dB
Dynamic Range	Normal
Advanced	
RBW Filter	Flat
Res BW	5.0 MHz
RRC Filter	Off
Alpha	0.220
Chip Rate	3.840 MHz
Time Ref Offset	0.000 s
RRC Filter Filter Alpha Offset Ch Range: ADC Range Relative Atten	Off 0.220 (grayed out for Fast) (grayed out for FFT/Swp) Auto Peak 0.00 dB
Swp Acq Time	625.0 μ s (grayed out for FFT/Fast)

Key Reference
W-CDMA Measurement Keys

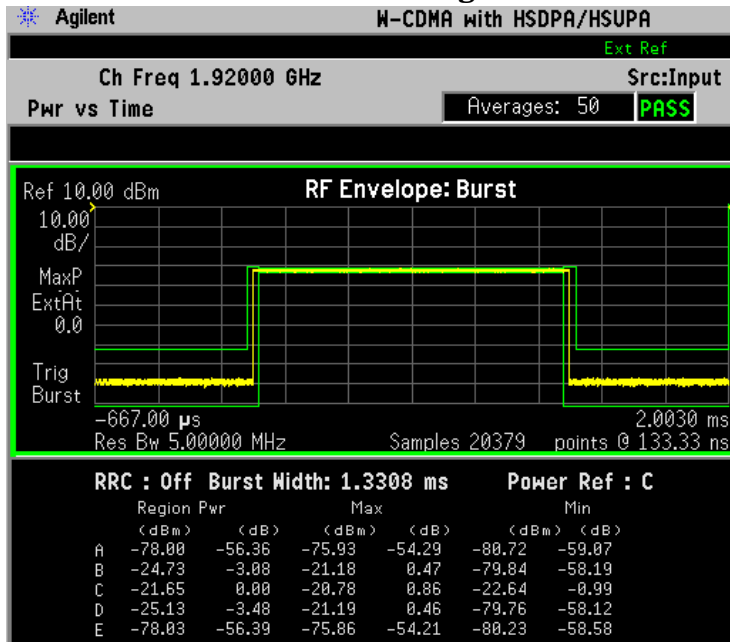
View/Trace Key Menu

Key Path: View/Trace

Figure 3-26 shows the all regions view, and Figure 3-27 shows the rise and fall regions view.

- **All** - Displays the whole burst waveform throughout the all regions.

Figure 3-26 Power vs. Time Measurement - All Regions View

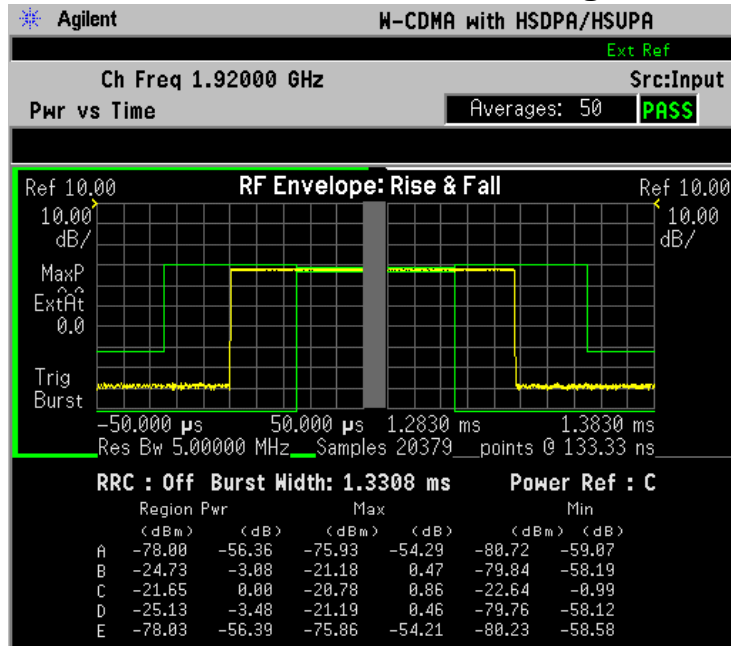


*Tester: View/Trace = All,
Other factory default settings

*Input signal: -10.00 dBm, W-CDMA (3GPP)

- **Rise & Fall** - Displays both the rising edge and the falling edge regions expanded in the horizontal scale.

Figure 3-27 Power vs. Time Measurement - Rise & Fall Regions View



*Tester: View/Trace = Rise & Fall,
Others = Factory default settings

*Input signal: -10.00 dBm, W-CDMA (3GPP)

While in this view, you can change the vertical scale by pressing the **AMPLITUDE Y Scale** key. You can also activate or deactivate the reference bandwidth markers by pressing the **Display** key.

- **Region A** through **Region E** - Displays each region from A through E in the full horizontal scale.

Display Key Menu

Key Path: **Display**

- **Limit Mask** - Allows you to control the limit mask display function between **On** and **Off**. If set to **On**, the upper and lower masks are displayed on the measurement display.

- **SPAN X Scale**
 - **Scale/Div** - Allows you to enter a time value to change the horizontal scale. The range is 1.0 ns to 1.000 s per division with 0.01 ns resolution. The default setting is 30.00 μ s, however, since the **Scale Coupling** is defaulted to **On**, this value is automatically determined by the measurement result. If you change this value manually, **Scale Coupling** automatically becomes **Off**.
 - **Ref Value** - Allows you to set the display reference value ranging from -1.00 to 10.00 s. The default setting is 0.00 s, however, since the **Scale Coupling** is defaulted to **On**, this value is automatically determined by the measurement result. If you change this value manually, **Scale Coupling** automatically becomes **Off**.
 - **Ref Position** - Allows you to set the display reference position to either **Left**, **Ctr** (center), or **Right**. The default setting is **Left**
 - **Scale Coupling** - Allows you to toggle the scale coupling function between **On** and **Off**. The default setting is **On**. Upon pressing the **Restart** front panel key or **Restart** softkey under the **Meas Control** menu, this function automatically determines the scale per division and reference values by the measurement results. If you change **Scale/Div** or **Ref Value** manually, **Scale Coupling** automatically becomes **Off**.
- **AMPLITUDE Y Scale**
 - **Scale/Div** - Allows you to enter a numeric value to change the vertical display sensitivity. The range is 0.10 to 20.00 dB with 0.01 dB resolution. The default setting is 10.00 dB, however, since the **Scale Coupling** is defaulted to **On**, this value is automatically determined by the measurement result. If you change this value manually, **Scale Coupling** automatically becomes **Off**.
 - **Ref Value** - Allows you to set the absolute power reference value ranging from -250.00 to 250.00 dBm with 0.01 dB resolution. The default setting is 10.00 dBm, however, since the **Scale Coupling** is defaulted to **On**, this value is automatically determined by the measurement result. If you change this value manually, **Scale Coupling** automatically becomes **Off**.
 - **Ref Position** - Allows you to set the display reference position to either **Top**, **Ctr** (center), or **Bot** (bottom). The default setting is **Top**.
 - **Scale Coupling** - Allows you to toggle the scale coupling function between **On** and **Off**. The default setting is **On**. Upon pressing the **Restart** front panel key or **Restart** softkey under the **Meas Control** menu, this function automatically determines the scale per division and reference values by the measurement results. If you change **Scale/Div** or **Ref Value** manually, **Scale Coupling** automatically becomes **Off**.

Marker Key Menu

Key Path: **Marker**

- **Select** - Allows you to activate up to four markers with the corresponding numbers, respectively. The selected number is underlined and its function is defined by pressing the **Function** key. The default setting is 1.
- **Normal** - Allows you to activate the selected marker to read the power level and time. The marker position is controlled either by manual adjustment of the RPG knob or by direct entry of the time value via the front panel keypad.
- **Delta** - Allows you to read the differences in the power levels and time scales between the selected marker and the next.
- **Function** - Allows you to set the selected marker function to **Band Power**, **Noise**, or **Off**. The default setting is **Off**. The **Band Power** and **Noise** functions are not available for this measurement.
- **Trace** - Allows you to place the selected marker on the **RF Envelope**, **Upper Mask**, or **Lower Mask** trace. The default setting is **RF Envelope**.
- **Off** - Allows you to turn off the selected marker.
- **Shape** - Allows you to access the menu to set the selected marker shape to **Diamond**, **Line**, **Square**, or **Cross**. The default setting is **Diamond**.
- **Marker All Off** - Allows you to turn off all of the markers.

QPSK EVM Keys

NOTE You must have selected **QPSK EVM** under the **MEASURE** key to access the following menus.

Meas Setup Key Menu

Key Path: **QPSK EVM, Meas Setup**

- **Predefined Constellation** - Allows you to select either a simple QPSK constellation or an RMC 12.2 (HPSK) constellation for uplink (MS) measurements.
- **Meas Interval** - Allows you to set the time interval in the number of chips over which the measurement is made. The range is 128 to 5120 chips.
- **Limits** - Allows you to set the PASS/FAIL limits to which the measurement is made. Two test limits are selectable, **RMS EVM** in percent and **Freq Error**.
- **Spectrum** - Allows you to toggle the spectrum function between **Normal** and **Invert**.
- **Restore Meas Defaults** - Allows you to preset only the settings that are specific to the selected measurement by pressing **Meas Setup, More (1 of 2), Restore Meas Defaults**. This will set the measure setup parameters, for the currently selected measurement only, to the factory defaults.
- **Advanced** - Allows you to access the menu to change the following parameters:
 - **EVM Result I/Q Offset** - Allows you to select whether the displayed EVM result will include (**Std**) or **Exclude** the I/Q Origin Offset error value.
 - **Alpha** - Allows you to change the alpha value of the root-raised cosine filter. The range is 0.01 to 0.50.
 - **Chip Rate** - Allows you to change the chip rate. The range is 3.45600 to 4.22400 MHz.

- **ADC Range** - Allows you to access the following selection menu to define one of the ADC ranging functions:
 - Auto** - Select this to set the ADC range automatically. For most FFT measurements, the auto feature should not be selected. An exception is when measuring a “bursty” signal, in which case **Auto** can maximize the time domain dynamic range, if FFT results are less important to you than time domain results.
 - Auto Peak** - Select this to set the ADC range automatically to the peak signal level. **Auto Peak** is a compromise that works well for both CW and burst signals.
 - Auto Peak Lock** - Select this to hold the ADC range automatically at the peak signal level. **Auto Peak Lock** is more stable than **Auto Peak** for CW signals, but should not be used for “bursty” signals.
 - Manual** - Allows you to access the selection menu: **-6 dB, 0 dB, +6 dB, +12 dB, +18 dB, +24 dB**, to set the ADC range level. Also note that manual ranging is best for CW signals.

Table 3-15 shows the factory default settings for QPSK EVM measurements.

Table 3-15 QPSK EVM Measurement Defaults

Measurement Parameter	Factory Default Condition
View/Trace	I/Q Measured Polar Graph
Meas Setup:	
Avg Number	10; On
Avg Mode	Repeat
Predefined Constellation	QPSK
Meas Interval	2560 chips
Trig Source	Free Run (Immediate)
Advanced	
EVM Result I/Q Offset	Std
Alpha	0.220
Chip Rate	3.84000 MHz
ADC Range	-6 dB (12-bit ADC for VSA) None (14-bit ADC for VSA and PSA)

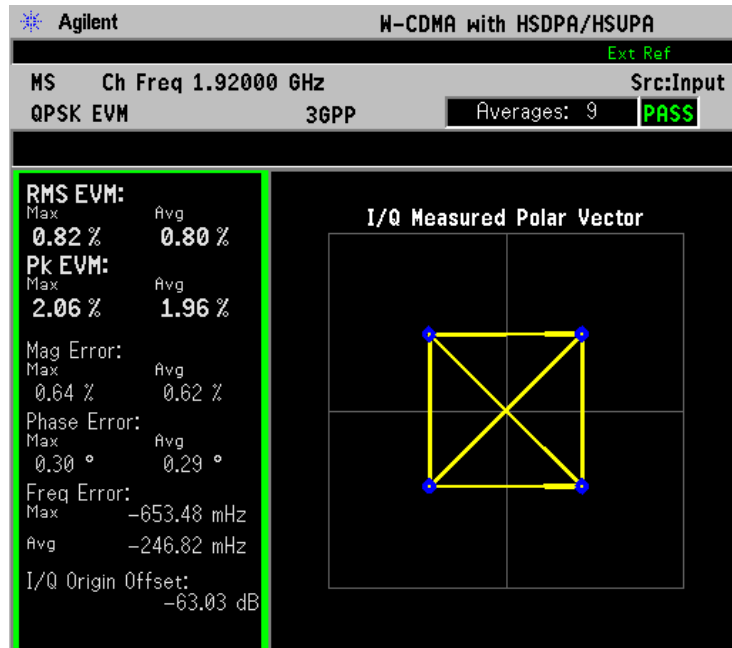
Key Reference
W-CDMA Measurement Keys

View/Trace Key Menu

Key Path: View/Trace

- **I/Q Measured Polar Graph** - Provides a combination view of an I/Q measured polar vector graph and the summary data (as shown in [Figure 3-28](#)).

Figure 3-28 QPSK EVM Measurement - I/Q Measured Polar Graph

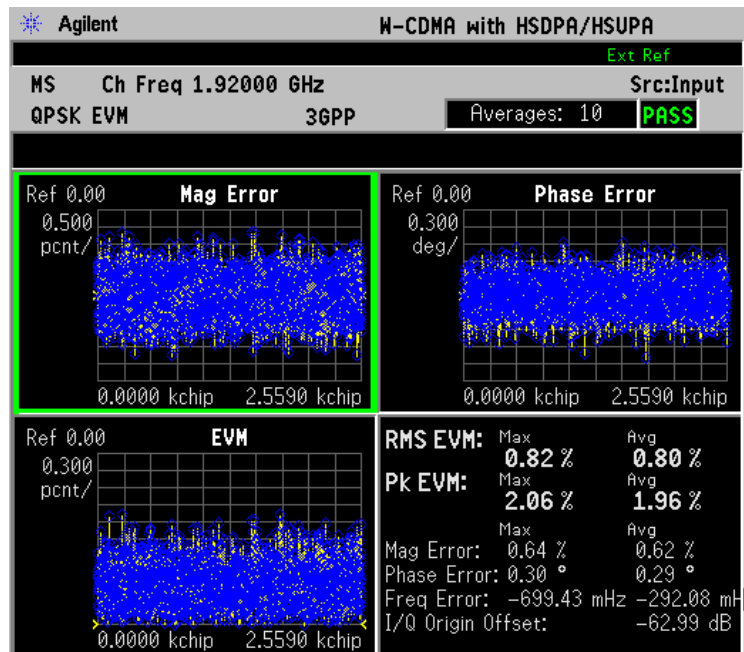


*Meas Setup: Trig Source = Frame,
Others = Factory default settings

*Input signals: -10 dBm, DPCCH

- **I/Q Error (Quad View)** - Provides a combination view of a magnitude error, phase error, EVM graphs, and the modulation accuracy summary data such as rho, peak and rms EVM, peak code domain error, magnitude error, phase error, and so forth in the text window (as shown in [Figure 3-29](#)).

Figure 3-29 QPSK EVM Measurement - I/Q Error Quad View



*Meas Setup: View/Trace = I/Q Error (Quad View),
Trig Source = Frame,
Others = Factory default settings

*Input signals: -10 dBm, DPCCH

Any one of these windows can be selected by the **Next Window** key and made full size by the **Zoom** key.

Display Key Menu

Key Path: **Display**

- **I/Q Polar Vec/Constln** - Allows you to specify the format of the Polar Vector graph display by providing a menu with the following selections:
 - **Vector and Constellation**
 - **Vector Only**
 - **Constellation Only**
- **Chip Offset** - Allows you to specify the number of chips offset from the first chip in a captured slot. The ranges are determined depending on the **Meas Interval** selections as shown in the table below.

Chip Offset (chips)	I/Q Chips
Min: 0 Max: Meas Interval - (I/Q_chips)	Min: 1 Max: Meas Interval

- **I/Q Chips** - Allows you to specify the number of I/Q chips displayed for the I/Q waveforms. The ranges are dependent on the **Device** and **SCH Include** selections as shown in the above table.
- **Interpolation** - Allows you to toggle the interpolation function between **On** and **Off**. If set to **On**, the solid lines between chip dots are converted to smoothed curves by the interpolation function. This is grayed out if the **I/Q Measured Polar Constln** view is selected in the **View/Trace** menu.
- **+45 deg Rot** - Allows you to toggle the display rotation function between **On** and **Off**. If set to **On**, the I/Q polar vector or I/Q polar constellation graph is rotated by +45 degrees to provide a rectangular display.
- **Full Vector (Background)** - Allows you to toggle the full vector display function between **On** and **Off**. If set to **On**, the full vector traces in gray color are displayed in the background of the polar vector solid traces in yellow. Both traces can be interpolated by the **Interpolation** key. This is grayed out if the **I/Q Measured Polar Constln** view is selected in the **View/Trace** menu.

NOTE

The following additional keys are active when **View/Trace, I/Q Error (Quad-View)** is selected, and when the EVM, Phase Error, or Mag Error window is active.

- **SPAN X Scale**
 - **Scale/Div** - Allows you to set the horizontal scale by changing a chip value per division. The range is 1.000 to 500000.0 chips per division with 0.001 chip resolution. The default setting is 256 chips per division. When the **Scale Coupling** default setting **On** is in effect, displayed plots use a Scale/Div value determined by the analyzer, based on the measurement result.
 - **Ref Value** - Allows you to set the chip reference value ranging from 0.000 to 5000000.0 chips. The default setting is 0.000 chip. When the **Scale Coupling** default setting **On** is in effect, displayed plots use a Scale/Div value determined by the analyzer, based on the measurement result.
 - **Ref Position** - Allows you to set the reference position to either **Left**, **Ctr** (center) or **Right**. The default setting is **Left**.
 - **Scale Coupling** - Allows you to toggle the scale coupling function between **On** and **Off**. The default setting is **On**. Upon pressing the **Restart** front panel key or **Restart** softkey under the **Meas Control** menu, this function automatically determines the scale per division and reference values based on the measurement results.

NOTE

The following additional keys are active when **View/Trace**, **I/Q Error (Quad-View)** is selected, and when the EVM or Mag Error window is active.

- **AMPLITUDE Y Scale**
 - **Scale/Div** - Allows you to set the vertical scale by changing the value per division. The range is 0.100 to 50.0% per division. The default setting is 5.00%. When the **Scale Coupling** default setting **On** is in effect, displayed plots use a Scale/Div value determined by the analyzer, based on the measurement result.
 - **Ref Value** - Allows you to set the reference value ranging from 0.00 to 500.0%. The default setting is 0.00%. When the **Scale Coupling** default setting **On** is in effect, displayed plots use a Scale/Div value determined by the analyzer, based on the measurement result.
 - **Ref Position** - Allows you to set the reference position to either **Top**, **Ctr** (center) or **Bot** (bottom). For the EVM graph, the default setting is **Bot**. For the Mag Error graph, the default setting is **Ctr**.
 - **Scale Coupling** - Allows you to toggle the scale coupling function between **On** and **Off**. The default setting is **On**. Upon pressing the **Restart** front panel key or **Restart** softkey under the **Meas Control** menu, this function automatically determines the scale per division and reference values based on the measurement results.

NOTE

The following additional keys are active when **View/Trace, I/Q Error (Quad-View)** is selected, and when the Phase Error window is active.

- **AMPLITUDE Y Scale**

- **Scale/Div** - Allows you to set the vertical scale by changing the value per division. The range is 0.01 to 3600 degrees. The default setting is 5.00 degrees per division. When the **Scale Coupling** default setting **On** is in effect, displayed plots use a Scale/Div value determined by the analyzer, based on the measurement result.
- **Ref Value** - Allows you to set the reference value ranging from -36000 to 36000 degrees. The default setting is 0.00 degrees. When the **Scale Coupling** default setting **On** is in effect, displayed plots use a Scale/Div value determined by the analyzer, based on the measurement result.
- **Ref Position** - Allows you to set the reference position to either **Top**, **Ctr** (center) or **Bot** (bottom). The default setting is **Ctr**.
- **Scale Coupling** - Allows you to toggle the scale coupling function between **On** and **Off**. The default setting is **On**. Upon pressing the **Restart** front panel key or **Restart** softkey under the **Meas Control** menu, this function automatically determines the scale per division and reference values based on the measurement results.

Marker Key Menu

Key Path: **Marker**

- **I/Q Error (Quad View)**

- **Select** - Allows you to activate up to four markers with the corresponding numbers, respectively. The selected number is underlined and its function is defined by pressing the **Function** key. The default setting is 1.
- **Normal** - Allows you to activate the selected marker to read the magnitude or phase error and the number of chips of the marker position on the selected trace. Marker position is controlled by the RPG knob.
- **Delta** - Allows you to read the differences in the magnitude or phase errors and the number of chips between the selected marker and the next.
- **Function** - Allows you to set the selected marker function to **Band Power**, **Noise**, or **Off**. The default setting is **Off**. The **Band Power** and **Noise** functions are not available for this measurement.
- **Trace** - Allows you to place the selected marker on the **EVM**, **Phase Error**, or **Mag Error** trace. The default setting is **EVM**.

- **Off** - Allows you to turn off the selected marker.
- **Shape** - Allows you to access the menu to set the selected marker shape to **Diamond**, **Line**, **Square**, or **Cross**. The default setting is **Diamond**.
- **Marker All Off** - Allows you to turn off all of the markers.

Spectrum Emission Mask Keys

NOTE

You must have selected **Spectrum Emission Mask** under the **MEASURE** key to access the following menus.

Meas Setup Key Menu

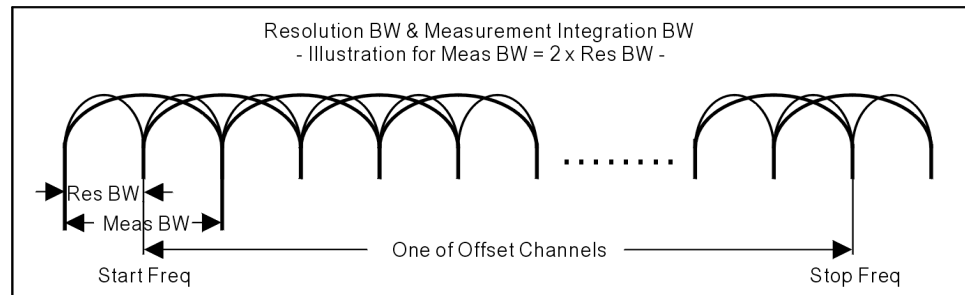
Key Path: **Spectrum Emission Mask, Meas Setup**

- **Meas Interval** - Allows you to specify the measurement interval ranging from 0.1 to 10.0 ms with 0.001 ms resolution.
- **Ref Channel** - Allows you to define the reference channel in the following terms:
 - **Chan Integ BW** - Allows you to specify the channel integration bandwidth ranging from 100.0 kHz to the setting of **Chan Span**. When **RRC Filter** is **On**, **Chan Integ BW** refers to the -3 dB bandwidth (e.g. clock rate for RRC filter).
 - **Chan Span** - Allows you to specify the channel span to be measured ranging from 100.000 kHz to 10.0000 MHz. When **RRC Filter** is **On**, **Chan Span** refers to the range of power integration bandwidth.
 - **Step Freq** - Allows you to specify the step frequency to make measurements ranging from 100.0 Hz to 7.50000 MHz, and to toggle this function between **Auto** and **Man**. If set to **Auto**, the step frequency is automatically set to half the **Res BW** setting. If set to **Man**, the step frequency is manually set independently from **Res BW**. When **RRC Filter** is **On**, **Step Freq** refers to data “buckets” to be integrated.
 - **Res BW** - Allows you to specify the resolution bandwidth ranging from 1.000 kHz to 7.50000 MHz, and to toggle this function between **Auto** and **Man**. If set to **Auto**, **Res BW** is automatically set to one 50th of **Chan Integ BW**. When **RRC Filter** is **On**, **Res BW** refers to data “buckets” to be integrated.

Key Reference
W-CDMA Measurement Keys

- **RRC Filter** - Allows you to include a Root Raised Cosine filter in the **Ref Channel** definition. When **RRC Filter** is **On**, **Chan Integ BW** refers to the -3 dB bandwidth (e.g. clock rate for RRC filter), **Chan Span** refers to the range of power integration bandwidth, while **Step Freq** and **Res BW** refer to data “buckets” to be integrated. The default setting for **RRC Filter** is **On**.
- **Filter Alpha** - Allows you to specify the alpha of the **RRC Filter** when selected above. The default setting for **Filter Alpha** is 0.22.
- **Spectrum Segment** - Allows you to toggle the frequency spectrum segment between **Offset** and **Region**. Upon selecting **Offset**, spectrum emission mask measurements are made. Upon selecting **Region**, spurious emission measurements are made. Depending on which is selected, either the **Offset/Limits** menu or the **Region/Limits** menu is available.
- **Offset/Limits** - Allows you to access the menus to change the following parameters for offset frequency settings and pass/fail tests, if **Spectrum Segment** is set to **Offset**. [Table 3-16 on page 318](#) and [Table 3-17 on page 319](#) show the default setting for BTS and MS measurements, respectively.
 - **Offset** - Allows you to access the memory selection menu from **A** to **E** to store up to 5 sets of values for **Start Freq**, **Stop Freq**, **Step Freq**, **Res BW**, and **Limits**. Only one memory selection at a time (A, B, C, D, or E) is shown on this key.
 - **Start Freq** - Allows you to specify the start frequency, and to toggle this function between **On** and **Off**, for each offset. The frequency range is 10.000 kHz to 100.000 MHz with 100 Hz resolution. However, the high end is limited to the setting of **Stop Freq**.
 - **Stop Freq** - Allows you to specify the stop frequency ranging from 10.000 kHz to 100.000 MHz with 100 Hz resolution, for each offset. The low end is limited to the setting of **Start Freq**.
 - **Step Freq** - Allows you to specify the step frequency ranging from $(\text{Stop Freq} - \text{Start Freq})/2000$ to 7.50000MHz, and to toggle this function between **Auto** and **Man**, for each offset. If set to **Auto**, the step frequency is automatically set to half the **Res BW** setting. If **Meas BW** is set to something other than 1, **Step Freq** is disabled because it is automatically coupled to **Res BW**.
 - **Res BW** - Allows you to specify the resolution bandwidth ranging from 300.0 Hz to 7.50000 MHz with 100 Hz resolution, and to toggle this function between **Auto** and **Man**, for each offset. If set to **Auto**, resolution bandwidth is automatically set to one 50th of $(\text{Stop Freq} - \text{Start Freq})$. [Figure 3-30](#) illustrates the relationship between **Meas BW**, **Start Freq**, and **Stop Freq**.

Figure 3-30 Resolution BW and Measurement Integration BW



- **Meas BW** - Allows you to specify a multiplier of **Res BW** for the measurement integration bandwidth ranging from 1 to $(\text{Stop Freq} - \text{Start Freq})/\text{Res BW}$. Refer to the above figure for the relationship between these functions.
- **Relative Atten** - Allows you to enter an attenuation value to adjust the relative level limits ranging from -40.00 to 0.00 dB with 0.01 dB resolution. The default attenuation is same as the one used by **Ref Channel**.
- **Offset Side** - Allows you to specify which offset side to be measured. Selections are **Neg** (negative offset), **Both**, and **Pos** (positive offset).
- **Limits** - Allows you to access the following menu to set up absolute and relative level limits and fail conditions for each offset:
 - Abs Start** - Allows you to enter an absolute level limit at **Start Freq** ranging from -200.00 to $+50.00$ dBm with 0.01 dB resolution.
 - Abs Stop** - Allows you to enter an absolute level limit at **Stop Freq** ranging from -200.00 to $+50.00$ dBm with 0.01 dB resolution, and to toggle this function between **Couple** and **Man**. If set to **Couple**, **Abs Stop** is coupled to **Abs Start** to make a flat limit line. If set to **Man**, **Abs Start** and **Abs Stop** can take different values to make a sloped limit line.
 - Rel Start** - Allows you to enter a relative level limit at **Start Freq** ranging from -150.00 to $+50.00$ dBc with 0.01 dB resolution.
 - Rel Stop** - Allows you to enter a relative level limit at **Stop Freq** ranging from -150.00 to $+50.00$ dBc with 0.01 dB resolution, and to toggle this function between **Couple** and **Man**. If set to **Couple**, **Rel Stop** is coupled to **Rel Start** to make a flat limit line. If set to **Man**, **Rel Start** and **Rel Stop** can take different values to make a sloped limit line.

- ❑ **Fail Mask**- Allows you to access the following menu to select one of the logic keys for fail conditions between the measurement results and the test limits:

Absolute - Fail is shown if one of the absolute spectrum emission mask measurement results is larger than the limit for **Abs Start** and/or **Abs Stop**. This is the default selection for each offset.

Relative - Fail is shown if one of the relative spectrum emission mask measurement results is larger than the limit for **Rel Start** and/or **Rel Stop**.

Abs AND Rel - Fail is shown if one of the absolute spectrum emission mask measurement results is larger than the limit for **Abs Start** and **Abs Stop** AND one of the relative spectrum emission mask measurement results is larger than the limit for **Rel Start** and **Rel Stop**.

Abs OR Rel - Fail is shown if one of the absolute spectrum emission mask measurement results is larger than the limit for **Abs Start** and **Abs Stop** OR one of the relative spectrum emission mask measurement results is larger than the limit for **Rel Start** and **Rel Stop**.

Table 3-16 Default Offsets & Limits for BTS Measurements

Offset	Start Freq (MHz)	Stop Freq (MHz)	Step Freq (kHz)	Meas BW (kHz)	Abs Start (dBm)	Abs Stop (dBm)	Rel Start (dBc)	Rel Stop (dBc)	Fail Mask
A, On	2.515	2.715	15.00	30.00	-12.50	-12.50	-30.00	-30.00	Abs
B, On	2.715	3.515	15.00	30.00	-12.50	-24.50	-30.00	-30.00	Abs
C, On	3.515	4.000	15.00	30.00	-24.50	-24.50	-30.00	-30.00	Abs
D, On	4.000	8.000	gray ^a	1000.00	-11.50	-11.50	-30.00	-30.00	Abs
E, On	8.000	12.500	500.00	1000.0	-11.50	-11.50	-30.00	-30.00	Abs

a. Step frequency is disabled and Meas BW is set to 20 times Res BW.

Table 3-17 Default Offsets & Limits for MS Measurements

Offset	Start Freq (MHz)	Stop Freq (MHz)	Step Freq (kHz)	Meas BW (kHz)	Abs Start (dBm)	Abs Stop (dBm)	Rel Start (dBc)	Rel Stop (dBc)	Fail Mask
A, On	2.515	3.485	15.00	30.00	-69.57	-69.57	-33.73	-48.28	AND
B, On	4.000	7.500	500.00	1000.0	-54.34	-54.34	-34.00	-37.50	AND
C, On	7.500	8.500	500.00	1000.0	-54.34	-54.34	-37.50	-47.50	AND
D, On	8.500	12.000	500.00	1000.0	-54.34	-54.34	-47.50	-47.50	AND
E, Off									

- **Region/Limits** - Allows you to access the menus to change the following parameters for region frequency settings and pass/fail tests, if **Spectrum Segment** is set to **Region**. [Table 3-18 on page 321](#) and [Table 3-19 on page 321](#) show the default setting for BTS and MS measurements, respectively.
 - **Region** - Allows you to access the memory selection menu from **A** to **E** to store up to 5 sets of values for **Start Freq**, **Stop Freq**, **Step Freq**, **Res BW**, and **Limits**. Only one memory selection at a time (**A**, **B**, **C**, **D**, or **E**) is shown on this key. The default selection is **A**.
 - **Start Freq** - Allows you to specify the start frequency, and to toggle this function between **On** and **Off**, for each region. The frequency range is 329.000 MHz to 3.67800 GHz with 1 kHz resolution. However, the high end is limited to the setting of **Stop Freq**. The default settings are 1.92000 GHz and **On**.
 - **Stop Freq** - Allows you to specify the stop frequency ranging from 329.000 MHz to 3.67800 GHz with 1 kHz resolution, for each region. The low end is limited to the setting of **Start Freq**. The default setting is 1.98000 GHz.
 - **Step Freq** - Allows you to specify the step frequency ranging from $(\text{Stop Freq} - \text{Start Freq})/2000$ to 7.50000MHz, and to toggle this function between **Auto** and **Man**, for each region. If set to **Auto**, the step frequency is automatically set to half the **Res BW** setting. The default settings are 600.000 kHz and **Auto**.
 - **Res BW** - Allows you to specify the resolution bandwidth ranging from 1.000 kHz to 7.50000 MHz with 1 kHz resolution, and to toggle this function between **Auto** and **Man**, for each region. If set to **Auto**, **Res BW** is automatically set to one 50th of $(\text{Stop Freq} - \text{Start Freq})$. The default settings are 1.2000 MHz and **Auto**.

— **Limits** - Allows you to access the following menu to set up absolute and relative level limits and fail conditions for each region:

- ❑ **Abs Start** - Allows you to enter an absolute level limit at **Start Freq** ranging from -200.00 to $+50.00$ dBm with 0.01 dB resolution. The default setting is -50.00 dBm.
- ❑ **Abs Stop** - Allows you to enter an absolute level limit at **Stop Freq** ranging from -200.00 to $+50.00$ dBm with 0.01 dB resolution, and to toggle this function between **Couple** and **Man**. If set to **Couple**, **Abs Stop** is coupled to **Abs Start** to make a flat limit line. If set to **Man**, **Abs Start** and **Abs Stop** can take different values to make a sloped limit line. The default settings are -50.00 dBm and **Couple**.
- ❑ **Rel Start** - Allows you to enter a relative level limit ranging from -150.00 to $+50.00$ dBc with 0.01 dB resolution. The default setting is -30.00 dBm.
- ❑ **Rel Stop** - Allows you to enter a relative level limit at **Stop Freq** ranging from -150.00 to $+50.00$ dBc with 0.01 dB resolution, and to toggle this function between **Couple** and **Man**. If set to **Couple**, **Rel Stop** is coupled to **Rel Start** to make a flat limit line. If set to **Man**, **Rel Start** and **Rel Stop** can take different values to make a sloped limit line. The default settings are -30.00 dBm and **Couple**.
- ❑ **Fail Mask** - Allows you to access the following menu to select one of the logic keys for fail conditions between the measurement results and the test limits. The default is absolute:

Absolute - Fail is shown if one of the absolute spurious emission mask measurement results is larger than the limit for **Abs Start** and **Abs Stop**. This is the default selection for each region.

Relative - Fail is shown if one of the relative spurious emission mask measurement results is larger than the limit for **Rel Start** and **Rel Stop**.

Abs AND Rel - Fail is shown if one of the absolute spurious emission mask measurement results is larger than the limit for **Abs Start** and **Abs Stop** AND one of the relative spurious emission mask measurement results is larger than the limit for **Rel Start** and **Rel Stop**.

Abs OR Rel - Fail is shown if one of the absolute spurious emission mask measurement results is larger than the limit for **Abs Start** and **Abs Stop** OR one of the relative spurious emission mask measurement results is larger than the limit

for Rel Start and Rel Stop.

Table 3-18 Default Regions & Limits for BTS Measurements

Region	Start Freq (GHz)	Stop Freq (GHz)	Step Freq (kHz)	Res BW (kHz)	Abs Start (dBm)	Abs Stop (dBm)	Rel Start (dBc)	Rel Stop (dBc)	Fail Mask
A, On	1.9200	1.9800	600.0	1200.0	-50.00	-50.00	-30.00	-30.00	Abs
B, On	1.8935	1.9196	261.0	522.0	-50.00	-50.00	-30.00	-30.00	Abs
C, On	2.1000	2.1050	50.0	100.0	-50.00	-50.00	-30.00	-30.00	Abs
D, Off									
E, Off									

Table 3-19 Default Regions & Limits for MS Measurements

Region	Start Freq (GHz)	Stop Freq (GHz)	Step Freq (kHz)	Res BW (kHz)	Abs Start (dBm)	Abs Stop (dBm)	Rel Start (dBc)	Rel Stop (dBc)	Fail Mask
A, On	1.9200	1.9800	600.0	1200.0	-50.00	-50.00	-30.00	-30.00	Abs
B, On	1.8935	1.9196	261.0	522.0	-50.00	-50.00	-30.00	-30.00	Abs
C, On	2.1000	2.1050	50.0	100.0	-50.00	-50.00	-30.00	-30.00	Abs
D, Off									
E, Off									

— **Relative Atten** - Allows you to enter an attenuation value to adjust the relative level limits ranging from -40.00 to 0.00 dB with 0.01 dB resolution. The default attenuation is the same as the one used by **Ref Channel**.

- **Detector** - Allows you to toggle the power detection type between **Avg** (average) and **Peak**. If set to **Avg**, the power in a bin is computed as RMS averaged over the entire **Meas Interval**. If set to **Peak**, the peak power in the entire **Meas Interval** is converted to the RMS value, assuming a CW signal.

- **Meas Type** - Allows you to access the menu to select one of the measurement reference types.

— **Total Pwr Ref** - Select this to set the measurement reference to the total carrier power and the measured data is shown in dBc and dBm.

— **PSD Ref** - Select this to set the measurement reference to the mean power spectral density of the carrier and the measured data is shown in dB and dBm/Hz.

Key Reference
W-CDMA Measurement Keys

- **Trig Source** - Allows you to select one of the trigger sources: **Free Run (Immediate)**, **Ext Front**, **Ext Rear**, **Frame**, or **Line**. The default setting is **Free Run (Immediate)**.
- **Restore Meas Defaults** - Allows you to preset only the settings that are specific to the selected measurement by pressing **Meas Setup, More (1 of 2), Restore Meas Defaults**. This will set the measure setup parameters, for the currently selected measurement only, to the factory defaults.

[Table 3-20](#) shows the factory default settings for spectrum emission mask measurements.

Table 3-20 Spectrum Emission Mask Measurement Defaults

Measurement Parameter	Factory Default Condition
View/Trace	All
Display:	Abs Peak Pwr & Freq
Limit Lines	On
Meas Setup:	
Avg Number	10; Off
Meas Interval	1.00 ms
Ref Channel:	
Chan Integ BW	3.84000 MHz
Chan Span	5.00000 MHz
Step Freq	38.400 kHz; Auto
Res BW	76.800 kHz; Auto
RRC Filter	On
Filter Alpha	.22
Spectrum Segment	Offset
Offset/Limits ^a :	(Refer to Table 3-16 on page 318)
Offset	A
Start Freq	2.51500 MHz; On
Stop Freq	2.71500 MHz
Step Freq	15.000 kHz; Auto
Res BW	30.000 kHz; Man
Meas BW (Integ BW) 1 × Res BW	30.000 kHz

Table 3-20 Spectrum Emission Mask Measurement Defaults

Measurement Parameter	Factory Default Condition
Relative Atten	0.00 dB
Offset Side	Both
Limits:	
Abs Start	-12.50 dBm
Abs Stop	-12.50 dBm; Couple
Rel Start	-30.00 dBc
Rel Stop	-30.00 dBc; Couple
Fail Mask	Absolute
Detector	Avg
Meas Type	Total Pwr Ref
Trig Source	Free Run (Immediate)

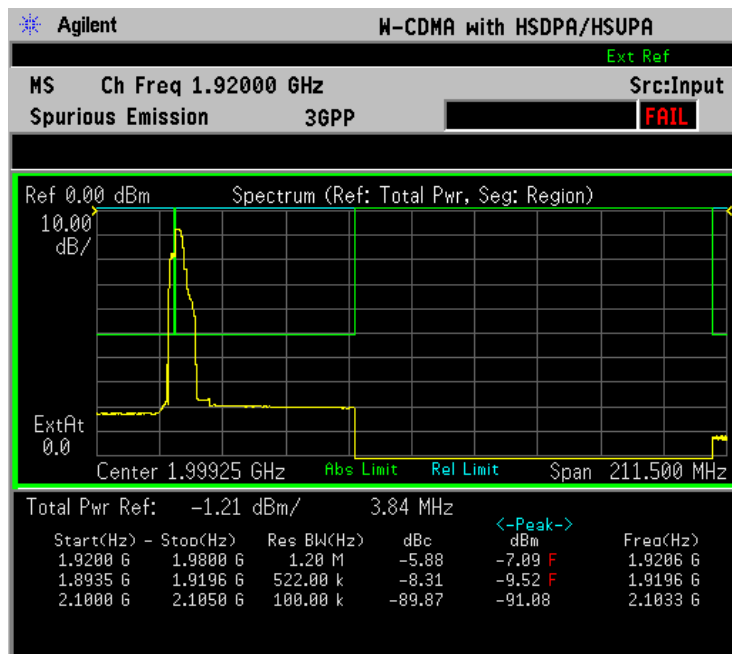
a. These are the defaults when Radio is set to BTS.

View/Trace Key Menu

Key Path: **View/Trace**

- **Spectrum Segment Offset**
 - **All** - In the factory default condition, the spectrum emission mask measurement graph is displayed with all of the active offsets in the graph window as shown in [Figure 3-31](#).
 - **Offset A to Offset E** - Each spectrum emission mask measurement result, up to 5 sets of offsets, is shown in the graph window. Each offset label set to **Off** is grayed out.
 - **Offset** - Allows you to toggle the display function of the offset sides between **Neg** (negative) and **Pos** (positive).
- **Spectrum Segment Region**
 - **All** - The spurious emission measurement graph is displayed with all of the active regions in the graph window as shown in [Figure 3-31](#).

Figure 3-31 Spurious Emission Measurement - All Regions View



*Meas Setup: Spectrum Segment = Region,
Others = Factory default settings

*Input signals: -20.00 dBm, Test Model 1 (16 DPCH)

- **Region A to Region E** - Each spurious emission measurement result, up to 5 sets of regions, is shown in the graph window. Each region label set to **Off** is grayed out.

Display Key Menu

Key Path: **Display**

- **AMPLITUDE Y Scale**

- **Scale/Div** - Allows you to enter a numeric value to change the vertical display sensitivity. The range is 0.10 to 20.00 dB with 0.01 dB resolution. The default setting is 10.00 dB. When the **Scale Coupling** default setting **On** is in effect, displayed plots use a Scale/Div value determined by the analyzer, based on the measurement result.
- **Ref Value** - Allows you to set the absolute power reference value ranging from -250.00 to 250.00 dBm with 0.01 dB resolution. The default setting is 10.00 dBm. When the **Scale Coupling** default setting **On** is in effect, displayed plots use a Scale/Div value determined by the analyzer, based on the measurement result.
- **Ref Position** - Allows you to set the reference position to either **Top**, **Ctr** (center), or **Bot** (bottom). The default setting is **Top**.
- **Scale Coupling** - Allows you to toggle the scale coupling function between **On** and **Off**. The default setting is **On**. Upon pressing the **Restart** front panel key or the **Restart** softkey under the **Meas Control** menu, this function automatically determines the scale per division and reference values based on the measurement results.
- **Limit Lines** - Allows you to toggle the limit lines display function for spectrum emission mask measurements between **On** and **Off**. If set to **On**, the absolute limit lines and the relative limit lines are shown on the spectrum emission mask measurement display.
- **Abs Peak Pwr & Freq** - Allows you to read the absolute peak power levels in dBm and corresponding frequencies in the text window. This key is disabled if **Spectrum Segment** is set to **Region**.
- **Rel Peak Pwr & Freq** - Allows you to read the relative peak power levels in dBc and corresponding frequencies in the text window. This key is disabled if **Spectrum Segment** is set to **Region**.
- **Integrated Power** - Allows you to read the absolute and relative power levels integrated throughout the bandwidths between the start and stop frequencies in the text window. This key is disabled if **Spectrum Segment** is set to **Region**.

Marker Key Menu

Key Path: **Marker**

- **Select 1 2 3 4** - Allows you to activate up to four markers with the corresponding numbers, respectively. The selected number is underlined and its function is defined by pressing the **Function** key. The default is 1.
- **Normal** - Allows you to activate the selected marker to read the frequency position and amplitude of the marker on the spectrum trace, for example. Marker position is controlled by the **RPG** knob.
- **Delta** - Allows you to read the differences in frequency positions and amplitudes between the selected marker and the next.
- **Function** - Allows you to define the selected marker function to be **Band Power**, **Noise**, or **Off**. The default is **Off**. For measuring **Band Power**, you need to place the **Normal** marker and then place the **Delta** marker.
- **Trace** - Allows you to place the selected marker on the **Spectrum** trace.
- **Off** - Allows you to turn off the selected marker.
- **Shape Diamond** - Allows you to access the menu to define the selected marker shape to be **Diamond**, **Line**, **Square**, or **Cross**. The default shape is **Diamond**.
- **Marker All Off** - Allows you to turn off all of the markers.

Spectrum (Frequency Domain) Keys

NOTE You must have selected **Spectrum** under the **MEASURE** menu to access these menus

Meas Setup Key Menu

Key Path: **Meas Setup**

- **Span** - Modifies the frequency span. The range is 10 Hz to 10 MHz with 1 Hz resolution, depending on the **Res BW** setting. Changing the span causes the resolution bandwidth to change automatically, and will affect data acquisition time. For PSA Option 122 wideband operation, the maximum span is 80 MHz. For PSA Option 140 wideband operation, the maximum span is 40 MHz.
- **Res BW** - Sets the resolution bandwidth for the FFT, and to toggle its mode between **Auto** and **Man** (manual). If set to **Auto**, the resolution bandwidth is set to **Span/50** (2% of the span). If set to **Man**, you can enter a value ranging from 100.0 mHz to 3.00000 MHz. A narrower bandwidth will result in a longer data acquisition time.
- **Wideband Setup** (PSA Options 122 and 140 only.) configures the wideband hardware path.
 - **Wideband IF Gain** - Sets the gain for the wideband IF path in 2 dB steps from -12 to +12 dB. You must have selected **IF Path Wide**. Increasing the gain can increase the amplitude of small signals as long as you don't overdrive the hardware. Wideband gain should usually be adjusted after setting the input attenuation.
 - **Wideband Filtering** - Accesses the keys to configure the optional channel filter. The default is no filtering.
 - Filter Type** - Selects **None** for no filtering, or **Raised Cosine**, **RRC** (root-raised cosine), **Nyquist**, **Root Nyquist**, and **Gaussian**.
 - Filter Alpha** - Selects the filter alpha.
 - Filter BW** - Selects filter bandwidth. Bandwidth is not entered as a frequency. The value is entered as a ratio of the current instrument sampling rate (i.e. BW/sample rate).
 - **Wideband Advanced** - These keys are only for the PSA Option 122 or 140 in wideband operation. Accesses the advanced settings for the wideband IF hardware path.

NOTE Parameters under the **Wideband Advanced** key seldom need to be changed. Any changes from the default advanced values may result in invalid measurement data.

Key Reference
W-CDMA Measurement Keys

- ❑ **ADC Corr** Turning corrections on performs an ADC calibration to reduce the spectral image and applies the corrections.
- ❑ **IF Flat Corr** turns IF flatness corrections on and off for the Option 122 or 140 wideband IF. This control is independent of the narrowband IF flatness control.
- ❑ **Analog Filter** manually selects the 80 MHz (Option 122), 40 MHz (Option 140), or 36 MHz anti-alias filter, which overrides the automatic selection of the bandwidth.
- ❑ **WB ADC Dither** Toggles the ADC dither function on/off.. The “ADC dither” refers to the introduction of noise to the digitized steps of the analog-to-digital converter; the result is an improvement in amplitude accuracy. The wideband dither control does not affect the ADC dither in the narrowband IF path.
- ❑ **FFT Window** - Accesses the following selection menu. Unless you are familiar with FFT windows, use the flat top filter (the default filter).
 - ❑ **Flat Top** - Selects this filter for best amplitude accuracy by reducing scalloping error.
 - ❑ **Uniform** - Select this filter to have no window active by using the uniform setting.
 - ❑ **Hanning** - Press this key to activate the Hanning filter.
 - ❑ **Hamming** - Press this key to activate the Hamming filter.
 - ❑ **Gaussian** - Press this key to activate the Gaussian filter with the roll-off factor (alpha) of 3.5.
 - ❑ **Blackman** - Press this key to activate the Blackman filter.
 - ❑ **Blackman Harris** - Press this key to activate the Blackman Harris filter.
 - ❑ **K-B 70dB/90dB/110dB (Kaiser-Bessel)** - Select one of the Kaiser-Bessel filters with sidelobes at -70, -90, or -110 dBc.

- ❑ **FFT Size** - Accesses the menu to change the following parameters:
 - ❑ **Length Ctrl** - Toggles the FFT and window length setting function between **Auto** and **Man** (manual).
 - ❑ **Min Pts in RBW** - Sets the minimum number of data points that will be used inside the resolution bandwidth. The range is 0.10 to 100.00 points with 0.01 resolution. This key is grayed out if **Length Ctrl** is set to **Man**.
 - ❑ **Window Length** - Enters the FFT window length in the number of capture samples, ranging from 8 to 1048576. This length represents the actual quantity of I/Q samples that are captured for processing by the FFT (“Capture Time” is the associated parameter shown on the screen). This key is grayed out if **Length Control** is set to **Auto**.
 - ❑ **FFT Length** - Enters the FFT length in the number of captured samples, ranging from 8 to 1048576. The FFT length setting is automatically limited so that it is equal to or greater than the FFT window length setting. Any amount greater than the window length is implemented by zero-padding. This key is grayed out if **Length Control** is set to **Auto**.
- **Average**
 - **Avg Number** - Changes the number of N averages.

- **Avg Mode** - Toggles the averaging mode between **Exp** (exponential) and **Repeat**. This selection only effects on the averaging result after the number of N averages is reached. The N is set using the **Avg Number** key.
 - **Normal averaging:** Normal (linear) averaging is always used until the specified number of N averages is reached. When the **Measure** key under **Meas Control** is set to **Single**, data acquisition is stopped when the number of N averages is reached, thus **Avg Mode** has no effect in the single measurement mode.
 - **Exponential averaging:** When **Measure** is set to **Cont**, data acquisition will continue indefinitely. Exponential averaging is used with a weighting factor of N (the displayed count of averages stops at N). Exponential averaging weights new data more heavily than old data, which allows tracking of slow-changing signals. The weighting factor N is set using the **Avg Number** key.
 - **Repeat averaging:** When **Measure** is set to **Cont**, data acquisition will continue indefinitely. After the number of N averages is reached, all previous result data is cleared and the average count displayed is set back to 1. This is equivalent to being in **Measure Single** and pressing the **Restart** key each time the single measurement finishes.
- **Avg Type** - Accesses the menu of the following average types only for making spectrum (frequency domain) and waveform (time domain) measurements:
 - Pwr Avg (RMS)** - Executes the true power averaging which is calculated by averaging the rms voltage. This is the most accurate type.
 - Log-Pwr Avg (Video)** - Simulates the traditional spectrum analyzer type of averaging by calculating the log of the power. This type of averaging will underestimate the power when the signal is noise-like.
 - Voltage Avg** - Executes voltage averaging.
 - Maximum** - Captures peak voltage data. Simulates the traditional spectrum analyzer peak hold function.
 - Minimum** - Captures the minimum voltage data, similar to the maximum function.

- **Time Avg Num** - Changes the number of time averages to be made when using the Option 122 or 140 wideband hardware (PSA only). This averaging requires a frame trigger and is much faster than the standard averaging. This hardware averaging is done on the complex voltage time trace data before any measurement application averaging is done. Both types of averaging can be done on the same measurement data.

When time averaging is being done, each trace update represents N fresh data acquisitions averaged together, where N is the number of averages. You cannot access the individual time records that are being averaged in the hardware averager.

NOTE If your triggering is not set correctly, the signal can be averaged away to nothing. A HW Average message is displayed to show that the averaging is on.

- **Trig Source**

Key path: **Meas Setup, Trig Source**

NOTE Changing the selection in the **Trig Source** menu alters the trigger source for the selected measurement only.

- **Free Run (Immediate)** - A trigger occurs at the time the data is requested, completely asynchronous with the RF or IF signal.
- **Video (Envlp)** - An internal IF envelope trigger that occurs at the absolute threshold level of the IF signal level.
- **RF Burst (Wideband)** - An internal wideband RF burst trigger that has the automatic level control for burst signals. It triggers at the level that is set relative to the peak RF signal (12 MHz bandwidth) input level. (Not available for Option 122 or 140 when using the wideband IF path.)
- **Ext Front** - Activates the front panel external trigger input (**EXT TRIGGER INPUT**) port. The external signal must be between -5.00 and $+5.00$ V with 1 or 10 mV resolution.
- **Ext Rear** - Activates the rear-panel external trigger input (**TRIGGER IN**) port. The external signal must be between -5.00 and $+5.00$ V with 1 or 10 mV resolution.
- **Frame** - Uses the internal frame clock to generate a trigger signal. The clock parameters are controlled under the **Mode Setup** key or the measurement firmware, but not both. Refer to the specific measurement section for details.
- **Line** - Sets the trigger to the internal line mode. Sweep triggers occur at intervals synchronous to the line frequency. See the specific measurement section for details.

Key Reference
W-CDMA Measurement Keys

- **IF Path** Only for PSA with Option B7J and either Option 122 or 140 installed. Selects either the standard narrowband IF hardware path or the wideband hardware.
- **Restore Meas Defaults** - Presets only the settings that are specific to the selected measurement by pressing **Meas Setup, More (1 of 2), Restore Meas Defaults**. This will set the measure setup parameters, for the currently selected measurement only, to the factory defaults.
- **(Narrowband) Advanced** Accesses the menu to change the following parameters.

NOTE

The advanced features should be used only if you are familiar with their operation. Changes from the default values may result in invalid data.

The **Narrowband** key word is only present if you have Option B7J and either Option 122 or 140 installed. Parameters that are under the **(Narrowband) Advanced** key only affect the standard narrow band IF path. The wideband IF advanced functions are found under the **Wideband Advanced** key.

- **Pre-ADC BPF** - Toggles the pre-ADC bandpass filter function between **On** and **Off**. The pre-ADC bandpass filter is useful for rejecting nearby signals, so that sensitivity within the span range can be improved by increasing the ADC range gain.
- **Pre-FFT Filtr** - Toggles the pre-FFT filter between **Flat** (flat top) and **Gaussian**. The pre-FFT filter defaults to a flat top filter which has better amplitude accuracy. The Gaussian filter has better pulse response.
- **Pre-FFT BW** - Toggles the pre-FFT bandwidth function between **Auto** and **Man** (manual). The pre-FFT bandwidth filter can be set between 1 Hz and 10 MHz. If set to **Auto**, this pre-FFT bandwidth is nominally 50% wider than the span. This bandwidth determines the ADC sampling rate.
- **FFT Window** - Accesses the following selection menu. Unless you are familiar with FFT windows, use the flat top filter (the default filter).
 - Flat Top** - Selects this filter for best amplitude accuracy by reducing scalloping error.
 - Uniform** - Select this filter to have no window active by using the uniform setting.
 - Hanning** - Press this key to activate the Hanning filter.
 - Hamming** - Press this key to activate the Hamming filter.
 - Gaussian** - Press this key to activate the Gaussian filter with the roll-off factor (alpha) of 3.5.

- Blackman** - Press this key to activate the Blackman filter.
 - Blackman Harris** - Press this key to activate the Blackman Harris filter.
 - K-B 70dB/90dB/110dB (Kaiser-Bessel)** - Select one of the Kaiser-Bessel filters with sidelobes at -70, -90, or -110 dBc.
- **FFT Size** - Accesses the menu to change the following parameters:
- Length Ctrl** - Toggles the FFT and window length setting function between **Auto** and **Man** (manual).
 - Min Pts in RBW** - Sets the minimum number of data points that will be used inside the resolution bandwidth. The range is 0.10 to 100.00 points with 0.01 resolution. This key is grayed out if **Length Ctrl** is set to **Man**.
 - Window Length** - Enters the FFT window length in the number of capture samples, ranging from 8 to 1048576. This length represents the actual quantity of I/Q samples that are captured for processing by the FFT (“Capture Time” is the associated parameter shown on the screen). This key is grayed out if **Length Control** is set to **Auto**.
 - FFT Length** - Enters the FFT length in the number of captured samples, ranging from 8 to 1048576. The FFT length setting is automatically limited so that it is equal to or greater than the FFT window length setting. Any amount greater than the window length is implemented by zero-padding. This key is grayed out if **Length Control** is set to **Auto**.
- **ADC Range** - Accesses the menu to define one of the following ADC ranging functions:
- Auto** - Sets the ADC range automatically. For most FFT spectrum measurements, the auto feature should not be selected. An exception is when measuring a signal which is “bursty”, in which case auto can maximize the time domain dynamic range, if FFT results are less important to you than time domain results.
 - Auto Peak** - Sets the ADC range automatically to the peak signal level. Auto peak is a compromise that works well for both CW and burst signals.
 - Auto Peak Lock** - Select this to hold the ADC range automatically at the peak signal level. Auto peak lock is more stable than auto peak for CW signals, but should not be used for “bursty” signals.
 - Manual** - Accesses the selection menu of values, -6 to +24 dB for E4406A or None to +18 dB for PSA, to set the ADC range level. Also note that manual ranging is best for CW signals.

- **Data Packing** - Selects **Auto** (the default) or the **Short (16 bit)**, **Medium (24 bit)** and **Long (32 bit)** methods of data packing. The short, medium, and long methods are not compatible with all settings and should not be used unless you are familiar with data packing methods. **Auto** is the preferred choice.
 - Auto** - The data packing value most appropriate for current instrument settings is selected automatically.
 - Short (16 bit)** - Select this to pack data every 16 bits.
 - Medium (24 bit)** - Select this to pack data every 24 bits.
 - Long (32 bit)** - Select this to pack data every 32 bits.
- **ADC Dither** - Toggles the ADC dither function between **Auto**, **On**, and **Off**. When set to **Auto** (the default), the ADC dither function will be activated when a narrow bandwidth is being measured, and deactivated when a wide bandwidth is being measured. “ADC dither” refers to the introduction of noise to the digitized steps of the analog-to-digital converter; the result is an improvement in amplitude accuracy. Use of the ADC dither, however, reduces dynamic range by approximately 3 dB.
- **Decimation** - Toggles the decimation function between **Auto** and **Man**, and to set the decimation value. **Auto** is the preferred setting, and the only setting that guarantees alias-free FFT spectrum measurements. If you are familiar with the decimation feature, you can change the decimation value by setting to **Man**, but be aware that aliasing can result in higher values. Decimation numbers 1 to 1000 describe the factor by which the number of points are reduced. The default setting is 0, which results in no data point reduction. Decimation by 3 keeps every 3rd sample, throwing away the 2 in between.
- **IF Flatness** - Toggles the IF flatness function between **On** and **Off**. If set to **On** (the default), the IF flatness feature causes background amplitude corrections to be performed on the FFT spectrum. The **Off** setting is used for adjustment and troubleshooting of the test instrument.

The following table shows the factory default settings for spectrum (frequency domain) measurements.

Table 3-21 Spectrum (Frequency Domain) Measurement Defaults

Measurement Parameter	Factory Default Condition
Trace Display	All
Res BW	20.0000 kHz; Auto250.000 Hz
Averaging:	
Avg Number	25; On
Avg Mode	Exp
Avg Type	Log-Pwr Avg (Video)
Time Avg Num (Opt. 122 or 140)	1
Trig Source	Free Run (Immediate)RF Burst (Wideband)
Region/Limits:	
Region	A
Upper Mask	A: -40.00 dB; On
Lower Mask	A: -100.00 dB; Off
Offset Start	A: -667.0 μ s
Offset Stop	A: -25.0 μ s
Interval	A: 642.0 μ s
IF Path (requires Option B7J and Option 122 or 140)	Narrow
Wideband IF Gain (Opt. 122 or 140)	0.00 dB
Wideband Filtering (Opt. 122 or 140)	None
Filter Type	0.30
Filter Alpha	0.50
Filter BW	
Spectrum View:	
SPAN	1.000 MHz (VSA), 10.000 MHz (PSA)
AMPLITUDE Y Scale - Scale/Div	100.000 kHz 10.00 dB
I/Q Waveform View:	
Capture Time	188.00 μ s15.06 ms
AMPLITUDE Y Scale - Scale/Div	100.0 mV60 mV
Spectrum Linear View:	(for E4406A)
SPAN	1.00000 MHz
AMPLITUDE Y Scale - Scale/Div	100.0 mV

Table 3-21 Spectrum (Frequency Domain) Measurement Defaults

Measurement Parameter	Factory Default Condition
I and Q Waveform View: Capture Time AMPLITUDE Y Scale - Scale/Div	(for E4406A) 188.00µs 100.0 mV
I/Q Polar View: I/Q Scale/Div I or Q Origin	(for E4406A) 100.0 mV 0.00 V
(Narrowband) Advanced	
Pre-ADC BPF	On
Pre-FFT Filter	Flat
Pre-FFT BW	1.55000 MHz 155.000 kHz; Auto
FFT Window	Flat Top (High Amptd Acc)
FFT Size:	
Length Control	Auto
Min Points/RBW	3.100000
Window Length	706 (VSA), 566 (PSA) 5648
FFT Length	1024 32768
ADC Range	Auto Peak
Data Packing	Auto
ADC Dither	Auto
Decimation	0; Auto
IF Flatness	On
Wideband Advanced (Option 122 or 140 PSA only)	
ADC Correction	On
IF Flatness Corrections	On
Analog Filter	Auto, 80 MHz (Opt 122), 40 MHz (Opt 140)
WB ADC Dither	On
FFT Window	Flat Top (High Amptd Acc)
FFT Size:	
Length Control	Auto
Min Points/RBW	3.100
Window Length	236 (Opt. 122), 118 (Opt. 140)
FFT Length	256 (Opt. 122), 128 (Opt. 140)

View/Trace Key Menu

The View/Trace key allows you to select the desired view of the measurement from the following. You can use the Next Window key to move between the multiple windows (if any) and make it full size by Zoom.

- **Spectrum** - Provides a combination view of the spectrum graph in parameters of power versus frequency with semi-log graticules, and the I/Q waveform graph in parameters of voltage and time. Changes to frequency span or power will sometimes affect data acquisition. This is equivalent to changing the selected window with the **Next** key.

Figure 3-32 Spectrum Measurement - Spectrum and I/Q Waveform (Default View)

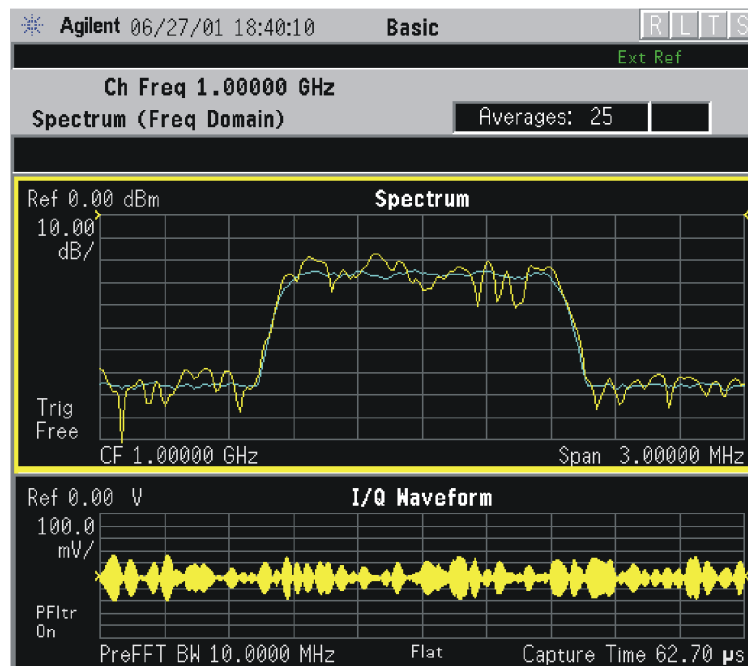


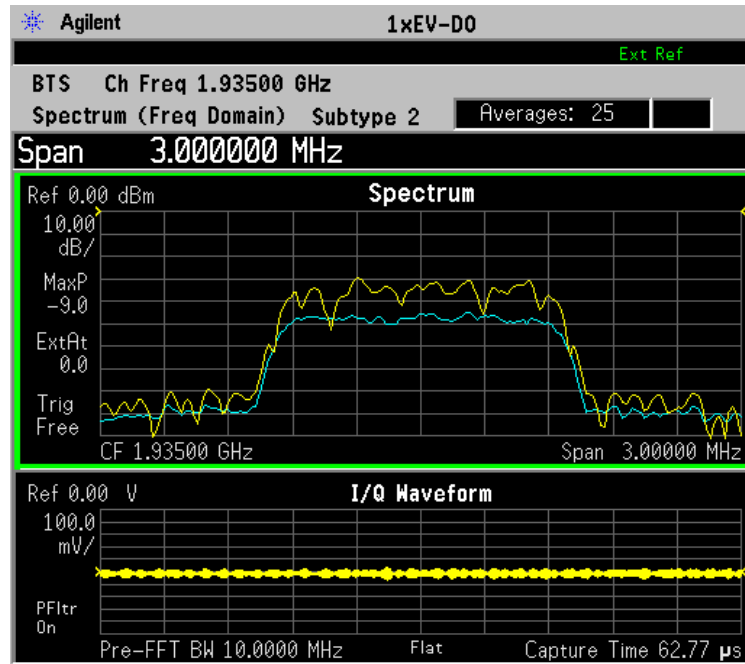
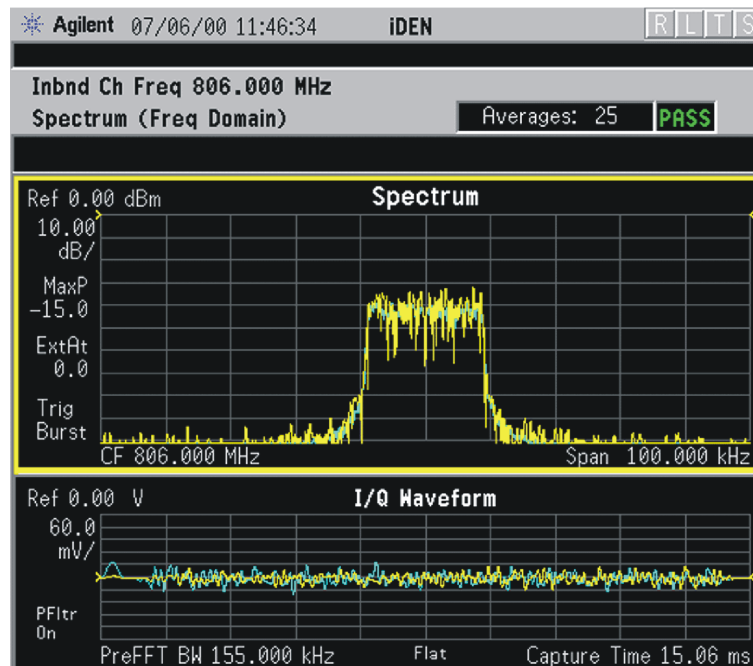
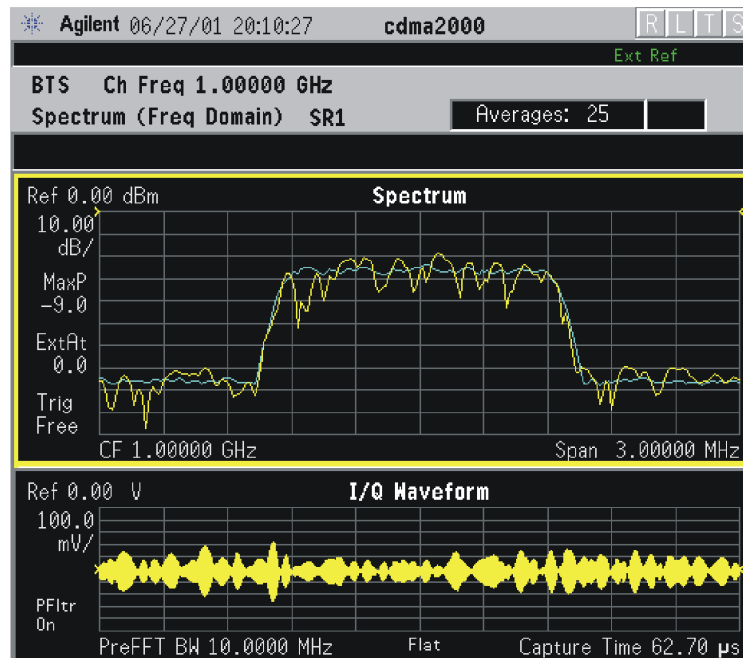
Figure 3-33 Spectrum Measurement - Spectrum and I/Q Waveform (Default View)**Figure 3-34** Spectrum Measurement - Spectrum and I/Q Waveform (Default View)

Figure 3-35 Spectrum Measurement - Spectrum and I/Q Waveform (Default View)



*Meas Setup: Span = 3.000 MHz, Capture Time = 62.70 μ s,
Others = Factory default settings

*Input signal: -10.00 dBm, Pilot channel of SR1, cdma2000 Rev 8

Figure 3-36 Spectrum Measurement - Spectrum and I/Q Waveform (Default View)

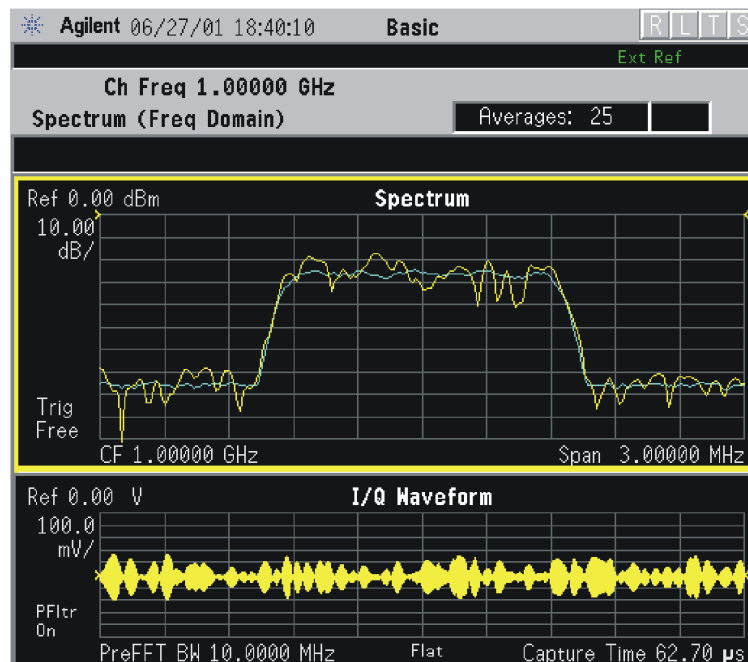


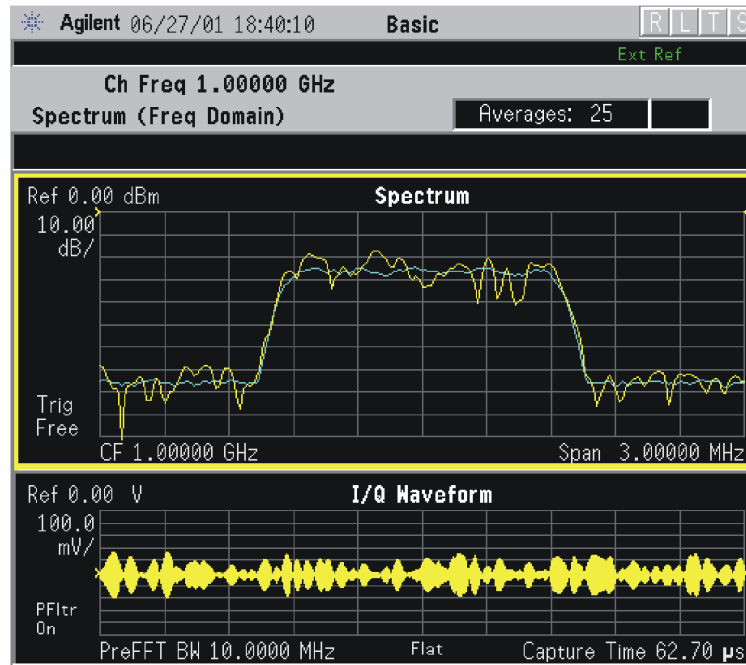
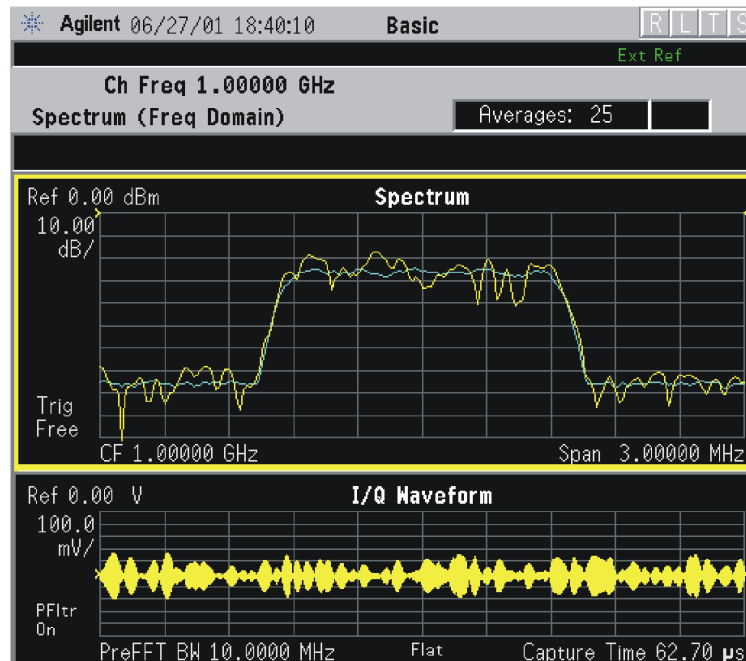
Figure 3-37 Spectrum Measurement - Spectrum and I/Q Waveform (Default View)**Figure 3-38** Spectrum Measurement - Spectrum and I/Q Waveform (Default View)

Figure 3-39 Spectrum Measurement - Spectrum and I/Q Waveform (Default View)

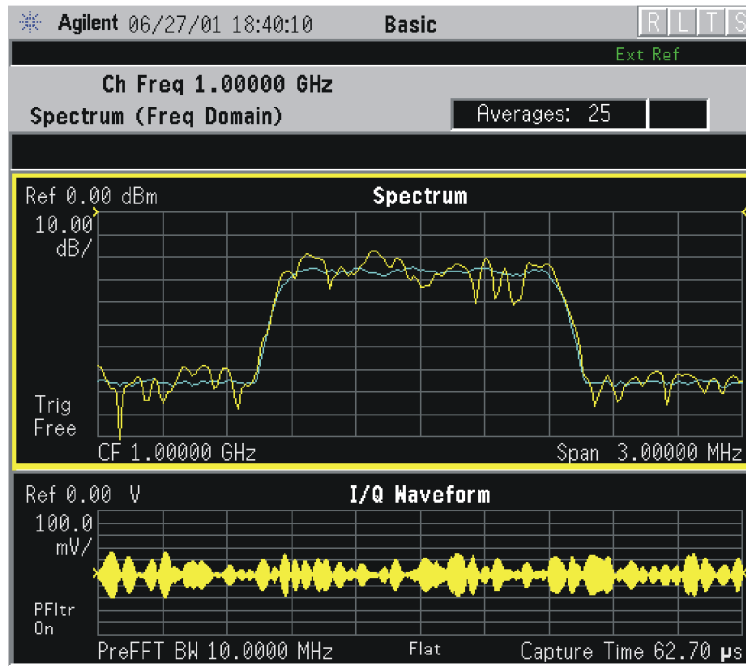


Figure 3-40 Spectrum Measurement - Spectrum and I/Q Waveform (Default View)

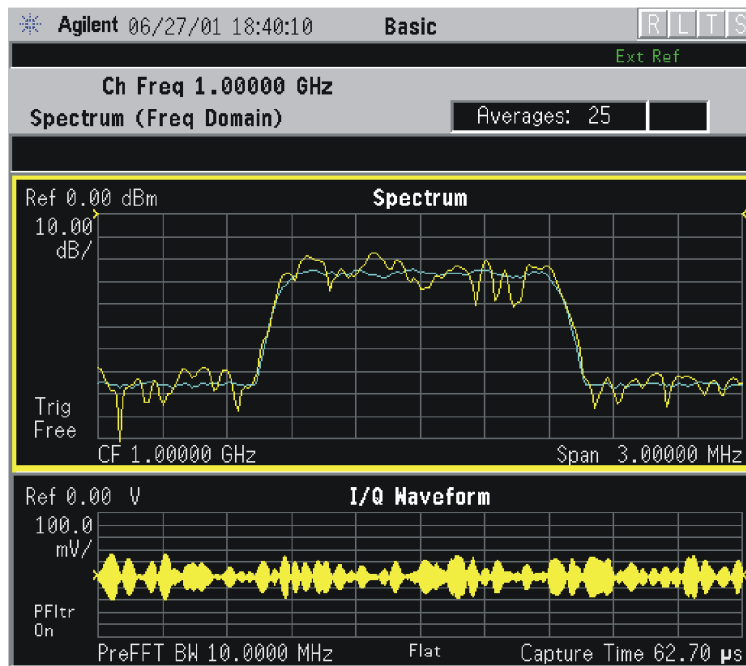


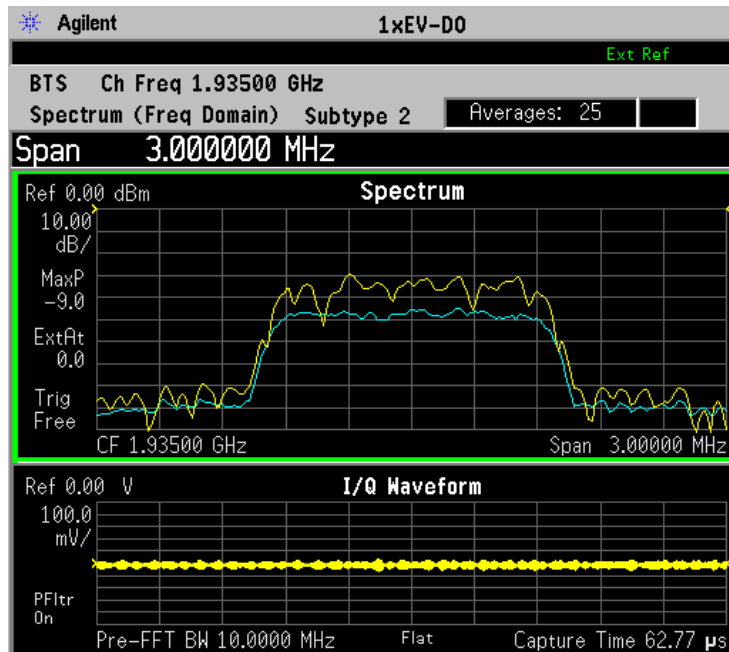
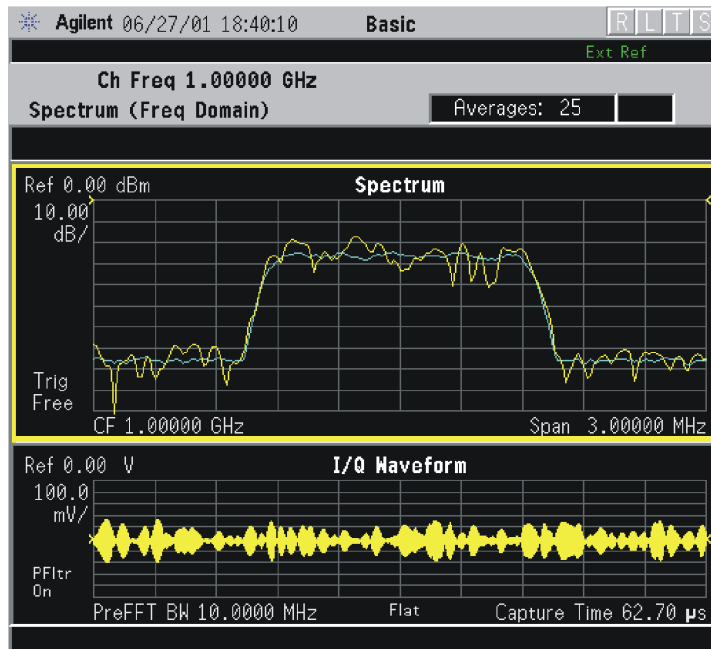
Figure 3-41 Spectrum Measurement - Spectrum and I/Q Waveform (Default View)**Figure 3-42** Spectrum Measurement - Spectrum and I/Q Waveform (Default View)

Figure 3-43 Spectrum Measurement - Spectrum and I/Q Waveform (Default View)

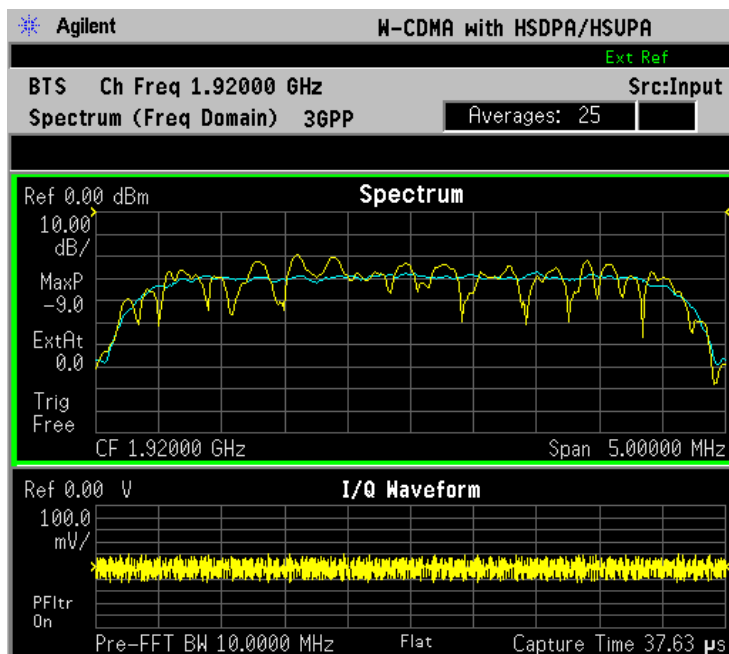


Figure 3-44 Spectrum Measurement - Spectrum and I/Q Waveform (Default View)

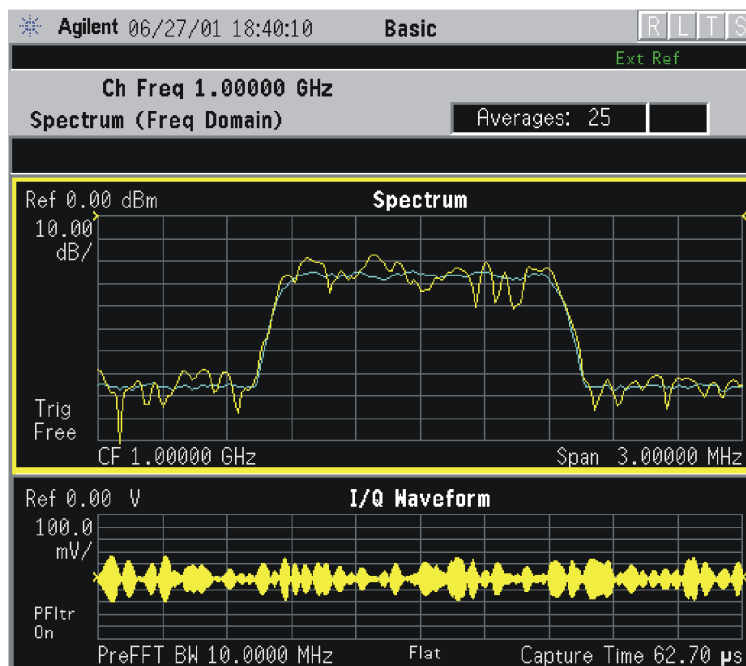
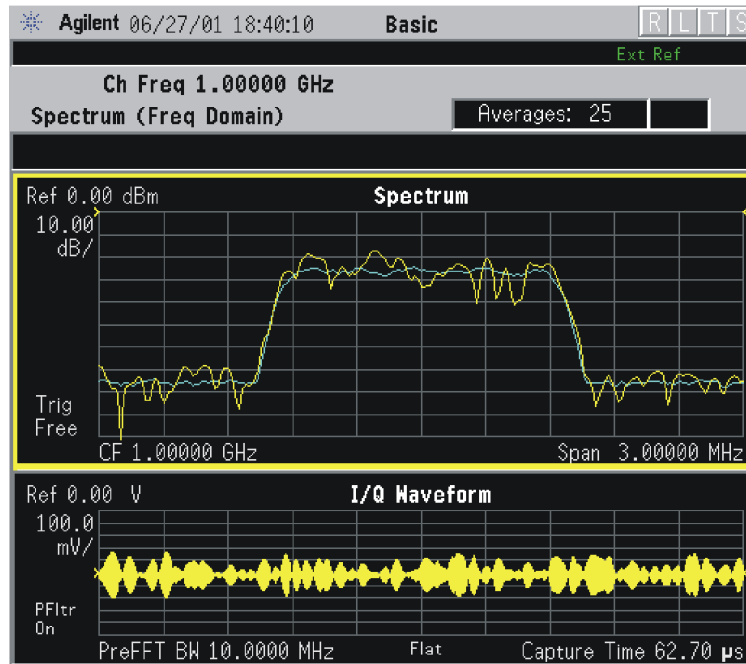
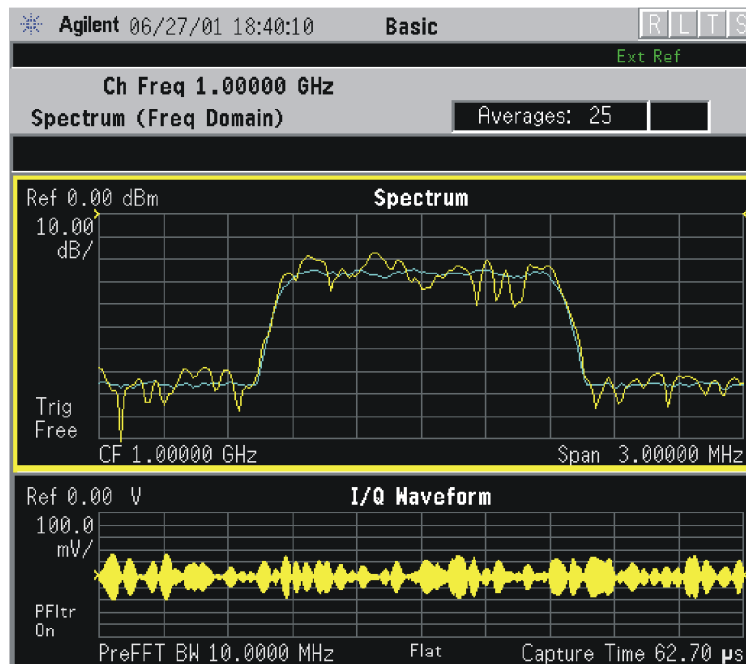
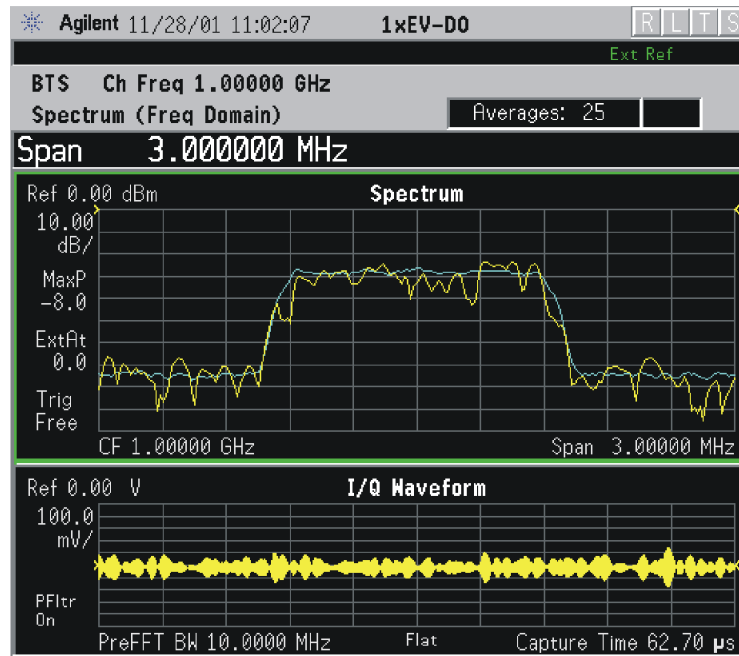


Figure 3-45 Spectrum Measurement - Spectrum and I/Q Waveform (Default View)**Figure 3-46** Spectrum Measurement - Spectrum and I/Q Waveform (Default View)

*Meas Setup: Span = 5.000 MHz,
Others = Factory default settings

*Input signals: **Figure 3-47** -10.00 dBm, PCCPCH + SCH

Figure 3-48 Spectrum Measurement - Spectrum and I/Q Waveform (Default View)

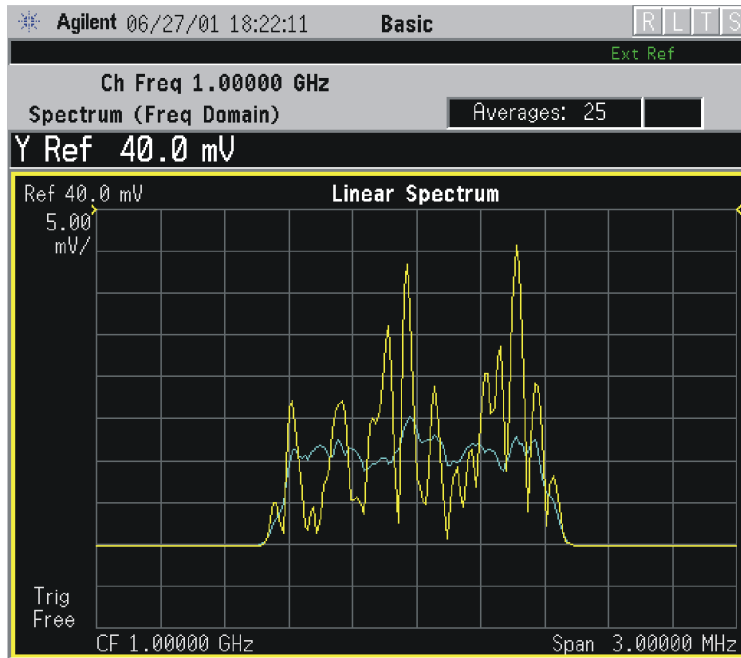
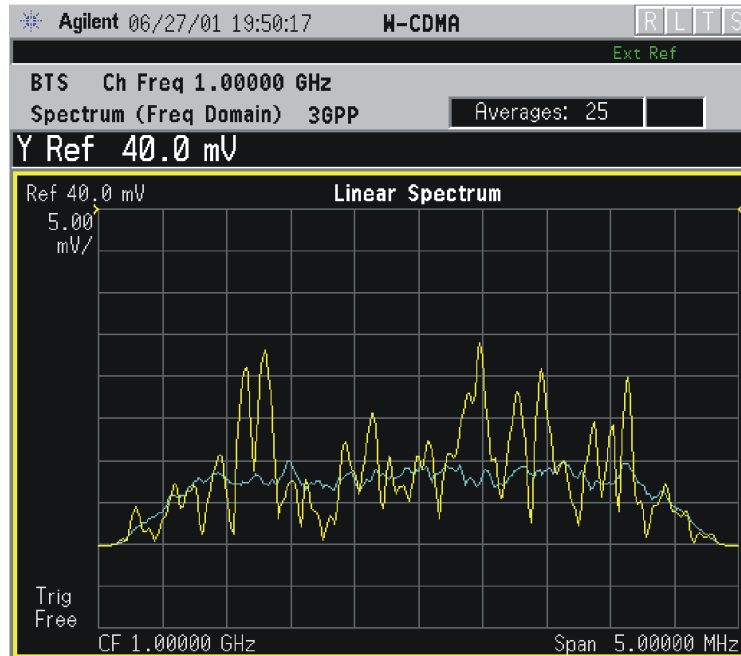


*Meas Setup: Span = 3.000 MHz, Capture Time = 62.70 μs, Others = Factory default settings

*Input signal: -10.00 dBm, Pilot channel, 1xEV-DO

The spectrum measurement result should look like the above figure. The measurement result values are shown in the summary result window.

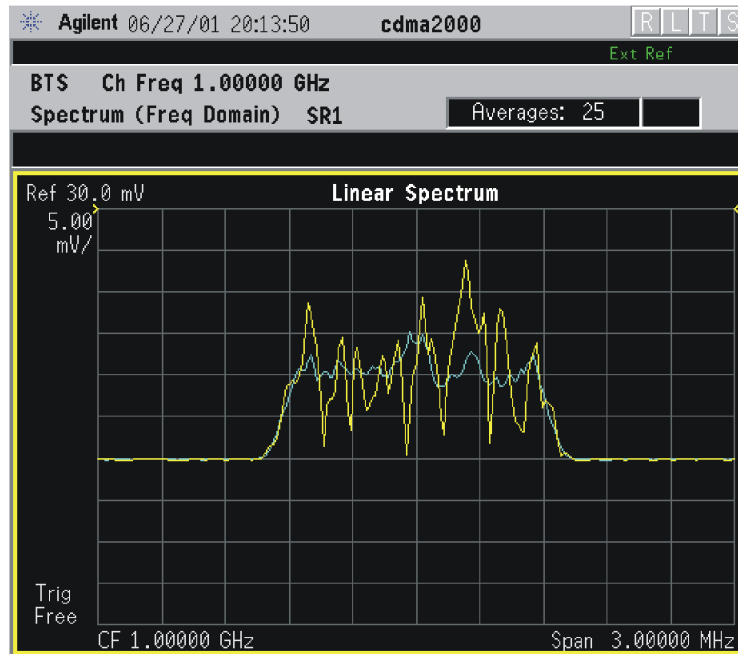
- **Spectrum (Time Domain) I/Q Waveform** - (Key for PSA only) This graph is shown below the **Spectrum** graph in the default dual-window display. **I/Q Waveform** provides a view of the I/Q waveform in parameters of voltage versus time in linear scale. Changes to sweep time or resolution bandwidth can affect data acquisition. Pressing this button is equivalent to pressing the **Next Window** button on the front panel. Press the **Zoom** key to view this display full-screen.
- **Spectrum Linear** - (for E4406A) Provides a view of the spectrum graph in parameters of voltage versus frequency in linear scale. Changes to frequency span or voltage can affect data acquisition.

Figure 3-49 Spectrum Measurement - Linear Spectrum View (for E4406A)**Figure 3-50** Spectrum Measurement - Linear Spectrum View (for E4406A)

*Meas Setup: View/Trace = Spectrum Linear,
Span = 5.000 MHz,
Y Scale/Div = 5.0 mV, Ref Value = 40.0 mV,
Others = Factory default settings

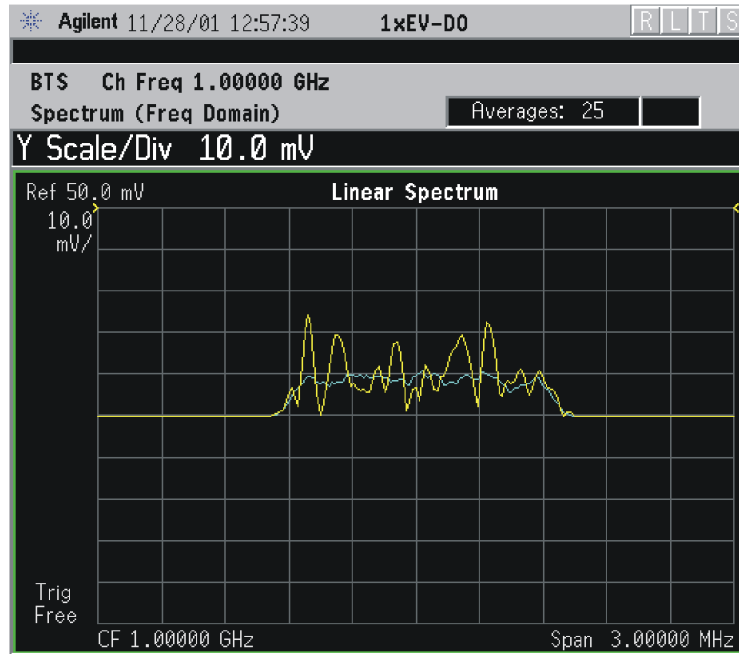
*Input signals: -10.00 dBm, PCCPCH + SCH

Figure 3-51 Spectrum Measurement - Linear Spectrum View (for E4406A)



*Meas Setup: View/Trace = Spectrum Linear,
Span = 3.000 MHz,
Y Scale/Div = 5.00 mV, Ref Value = 30.0 mV,
Others = Factory default settings

*Input signals: -10.00 dBm, 9 channels of SR1, cdma2000 Rev 8

Figure 3-52 Spectrum Measurement - Linear Spectrum View (for E4406A)

*Meas Setup: View/Trace = Spectrum Linear,
Span = 3.000 MHz,
Y Scale/Div = 10.00 mV, Ref Value = 50.0 mV,
Others = Factory default settings

*Input signals: -10.00 dBm, Pilot channel, 1xEV-DO

NOTE

(for E4406A) For the widest spans, the I/Q window becomes just “ADC time domain samples”, because the I/Q down-conversion is no longer in effect. This is not the case for E4406A Option B7C if the **Input Port** is set to either **I/Q**, **I only**, or **Q only** and you have connected baseband I/Q signals to the **I/Q INPUT** connectors.

- **I and Q Waveform** - (for E4406A) Provides individual views of the I and Q signal waveform windows in parameters of voltage versus time.

To select the I or Q trace view, press the **Next** key at the bottom of the display. The selected window will have a green outline. To view the window full size press the **Zoom** key.

Figure 3-53 Spectrum Measurement - I and Q Waveform View (for E4406A)

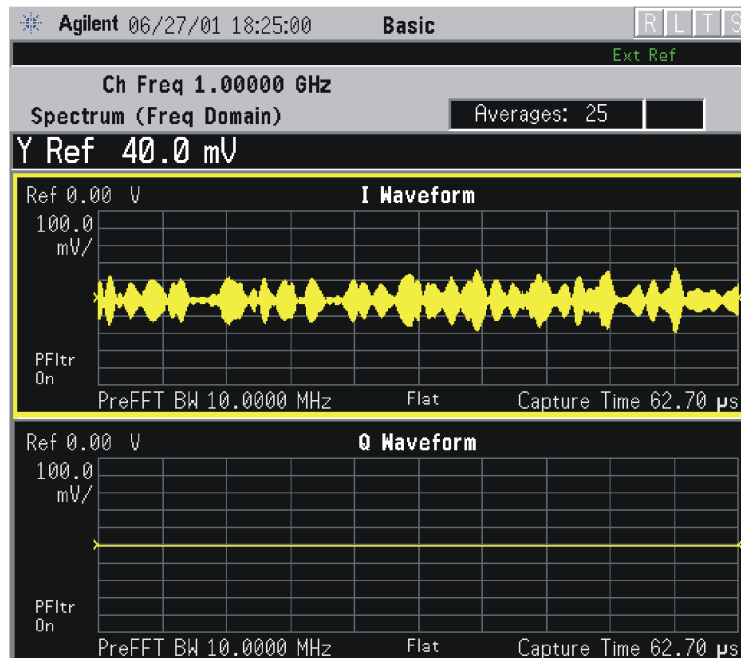
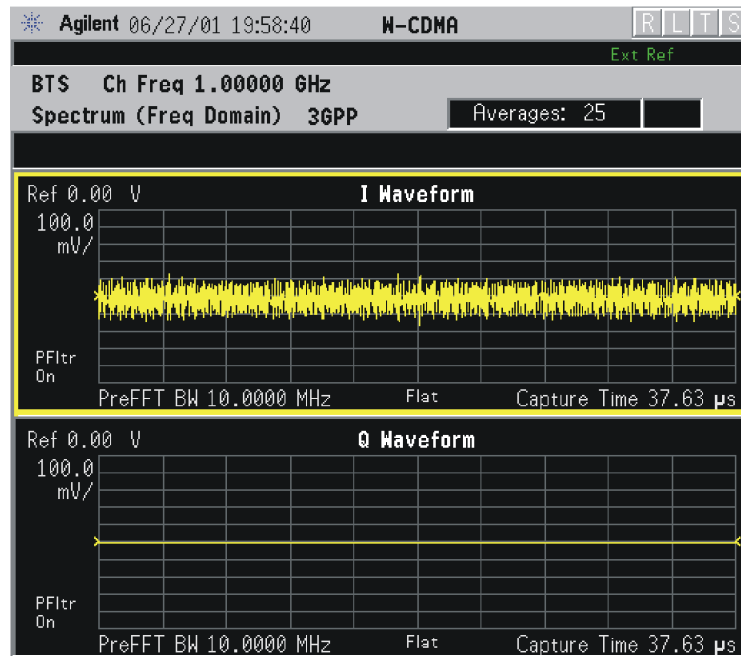


Figure 3-54 Spectrum Measurement - I and Q Waveform View (for E4406A)

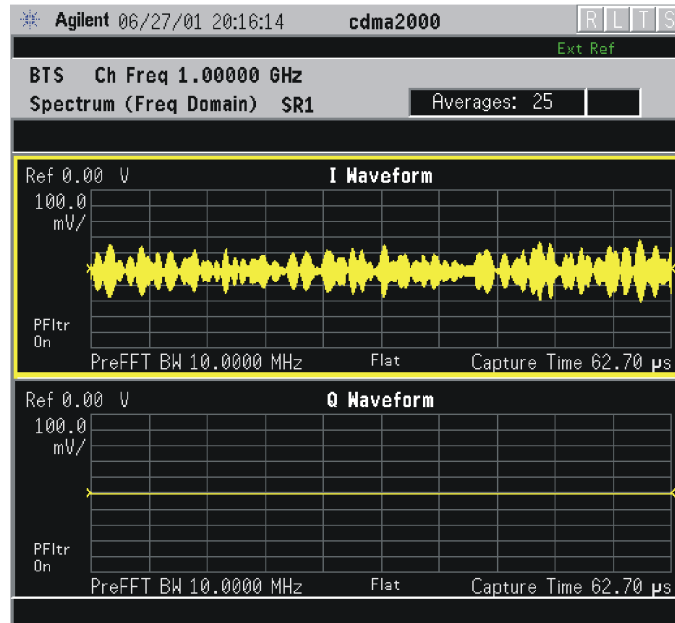


*Meas Setup: View/Trace = I and Q Waveform,
Others = Factory default settings

*Input signals: -10.00 dBm, PCCPCH + SCH

Key Reference
W-CDMA Measurement Keys

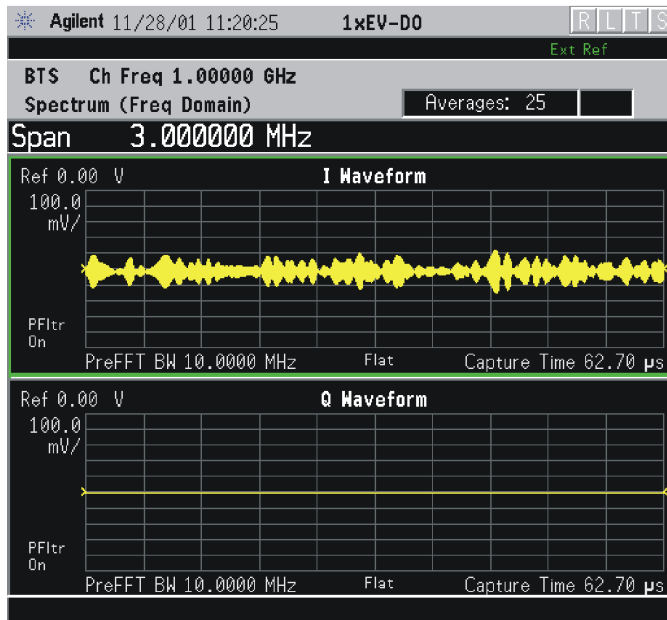
Figure 3-55 Spectrum Measurement - I and Q Waveform View (for E4406A)



*Meas Setup: View/Trace = I and Q Waveform,
AMPLITUDE Y Scale = 5.00 mV,
Others = Factory default settings

*Input signals: -10.00 dBm, 9 channels of SR1, cdma2000 Rev 8

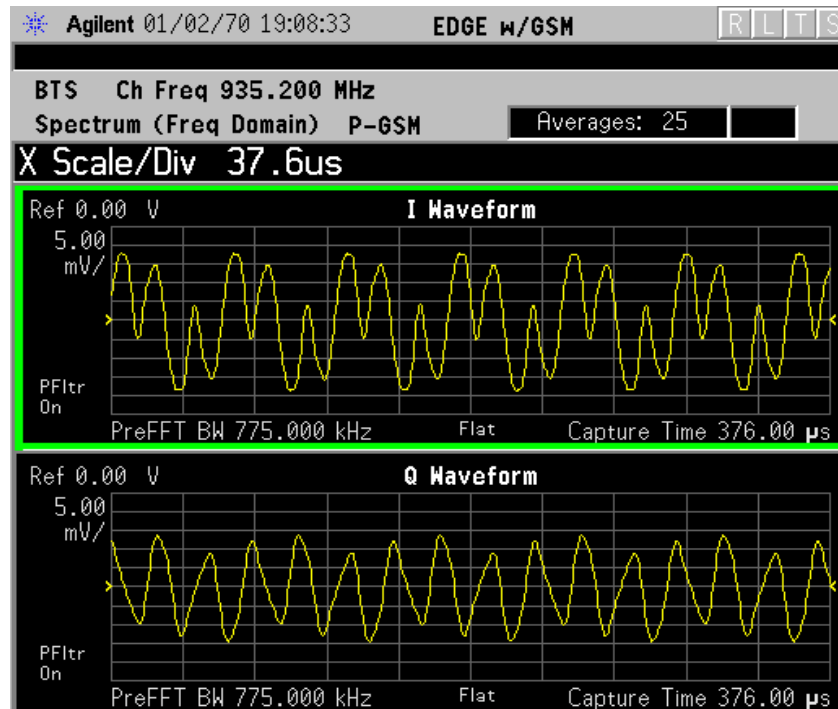
Figure 3-56 Spectrum Measurement - I and Q Waveform View (for E4406A)



*Meas Setup: View/Trace = I and Q Waveform,
Others = Factory default settings

*Input signals: -10.00 dBm, Pilot channel, 1xEV-DO

Figure 3-57 Spectrum Measurement - I and Q Waveform View (for E4406A)



- **I/Q Polar** - (for E4406A) Provides a view of the I/Q signal displayed in a polar vector graph.

Figure 3-58 Spectrum Measurement - I/Q Polar View (for E4406A)

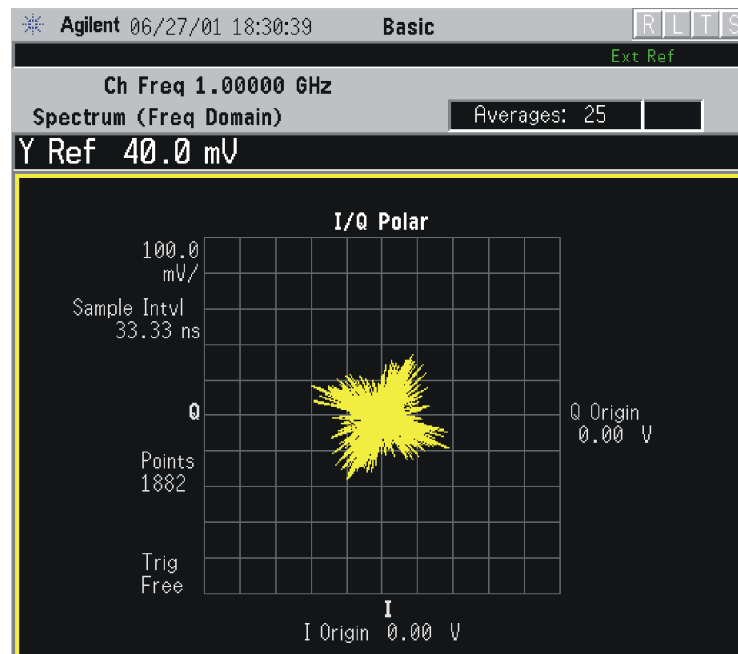
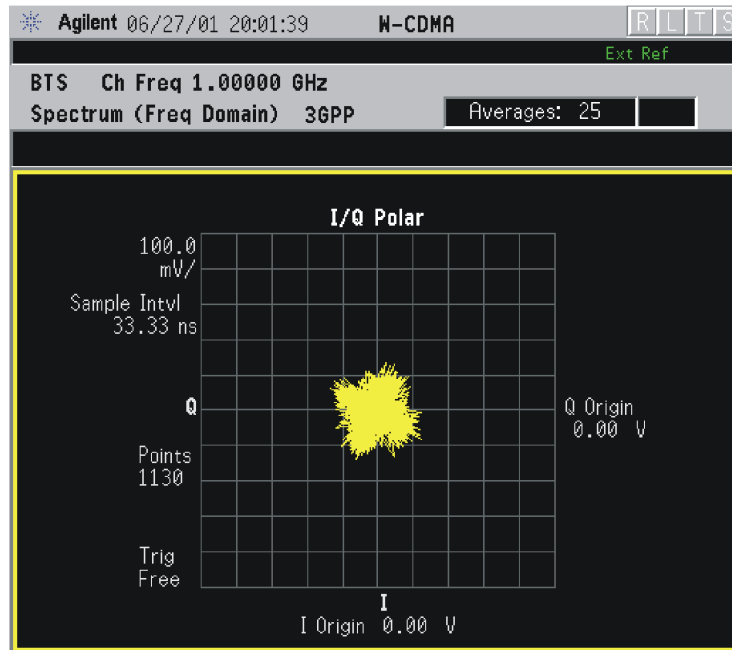
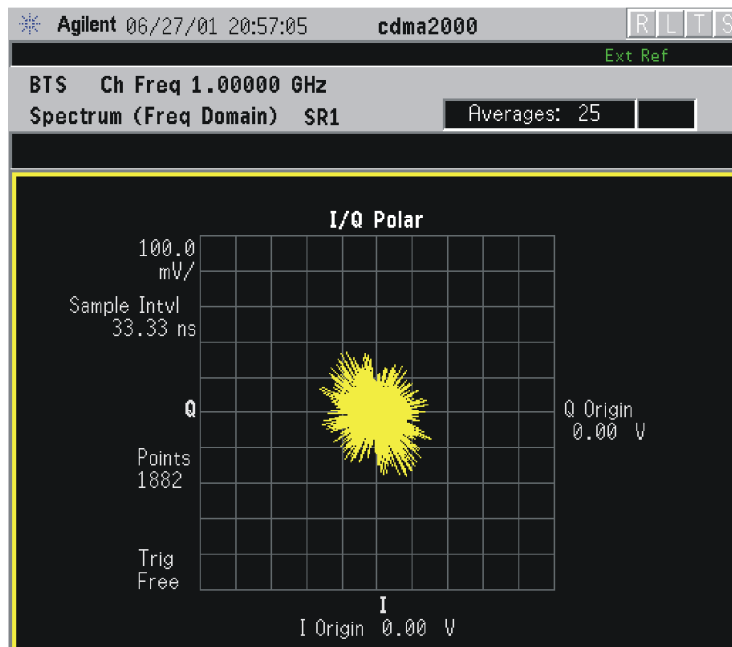


Figure 3-59 Spectrum Measurement - I/Q Polar View (for E4406A)

*Meas Setup: View/Trace = I/Q Polar,
Others = Factory default settings

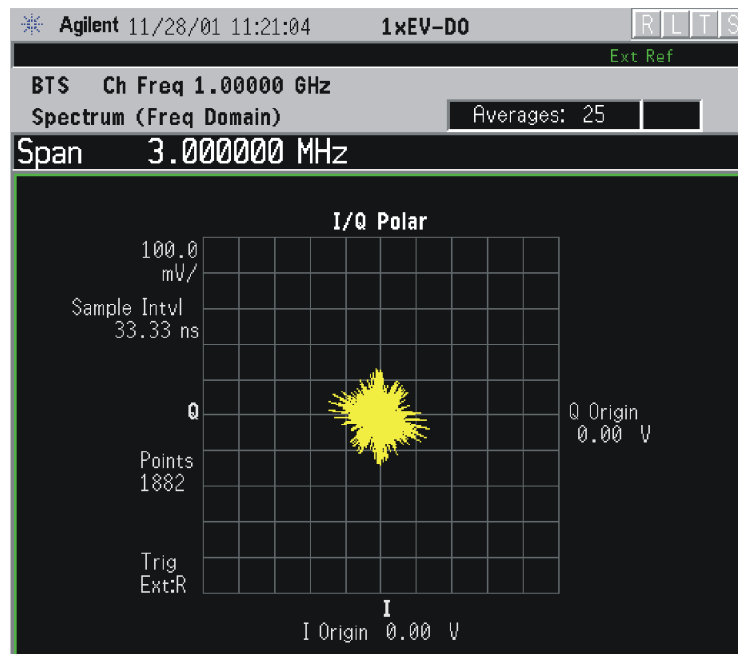
*Input signals: -10.00 dBm, PCCPCH + SCH

Figure 3-60 Spectrum Measurement - I/Q Polar View (for E4406A)

*Meas Setup: View/Trace = I/Q Polar,
Others = Factory default settings

*Input signals: -10.00 dBm, Pilot channel of SR1, cdma2000 Rev 8

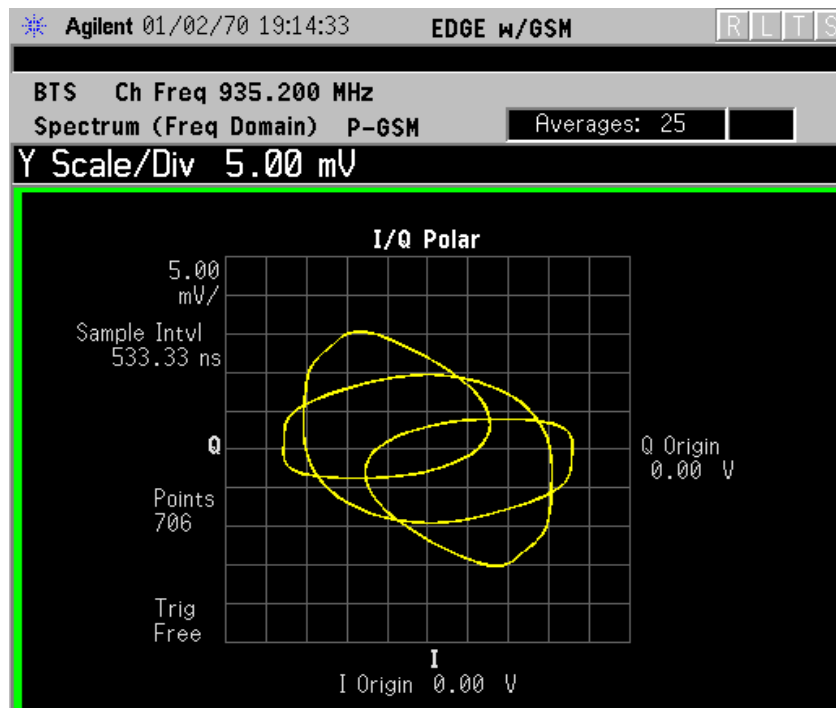
Figure 3-61 Spectrum Measurement - I/Q Polar View (for E4406A)



*Meas Setup: View/Trace = I/Q Polar,
Others = Factory default settings

*Input signals: -10.00 dBm, Pilot channel, 1xEV-DO

Figure 3-62 Spectrum Measurement - I/Q Polar View (for E4406A)



Key Reference
W-CDMA Measurement Keys

- **Trace Display** - Press this key to reveal the trace selection menu. The currently selected trace type is shown on the **Trace Display** key.
 - **All** - Views both the current trace and the average trace.
 - **Average** - Views only the average trace (in blue color). See the **Meas Setup, Average** keys to select different types of averaging.
 - **Current** - Views only the trace (in yellow color) for the latest data acquisition.
 - **I Trace** - (for E4406A) Views only the I signal trace.
 - **Q Trace** - (for E4406A) Views only the Q signal trace.

SPAN X Scale Key Menu

NOTE

The **Spectrum** or **Linear Spectrum** (for E4406A) window must be active in the **Spectrum** or **Spectrum Linear** (for E4406A) view to access the following **Span X Scale** key menu:

- **Span** - Modifies the frequency span. The range is 10.000 Hz to 10.000 MHz with 1 Hz resolution, depending on the **Res BW** setting. Changing the span causes the resolution bandwidth to change automatically, and will affect data acquisition time. The **Span** key is also accessible under the **Meas Setup** menu.
- **IF Path** - This key is only available if you have Option B7J and either Option 122 or 140. Selects either the standard narrowband IF hardware path or the wideband hardware path.

NOTE

The **I/Q Waveform** (for E4406A) window must be active in the **Spectrum** or **Spectrum Linear** (for E4406A) view to access the following **Span X Scale** key menu:

- **Scale/Div** - Sets the horizontal scale by changing a time value per division. The range is 1.00 ns to 1.00 s per division. The default setting is 18.8 ms per division. However, since the **Scale Coupling** default is **On**, this value is automatically determined by the measurement results. When you set a value manually, **Scale Coupling** automatically changes to **Off**.
- **Ref Value** - Sets the reference value ranging from -1.00 to 10.0 s. The default setting is 0.00 s. However, since the **Scale Coupling** default is **On**, this value is automatically determined by the measurement results. When you set a value manually, **Scale Coupling** automatically changes to **Off**.
- **Ref Position** - Sets the reference position to either **Left, Ctr** (center) or **Right**. The default setting is **Left**.

- **Scale Coupling** - Toggles the scale coupling function between **On** and **Off**. The default setting is **On**. Upon pressing the **Restart** front-panel key or **Restart** softkey under the **Meas Control** menu, this function automatically determines the scale per division and reference values based on the measurement results. When you set a value to either **Scale/Div** or **Ref Value** manually, **Scale Coupling** automatically changes to **Off**.

NOTE

The I/Q Polar window must be active in the **I/Q Polar** view (for E4406A), for the **SPAN X Scale** key to access the following menu:

- **I/Q Scale/Div** - Sets the vertical and horizontal scales by changing the value per division. The range is 1.00 nV to 20.00 V per division. The default setting is 100.0 mV.
- **I Origin** or **Q Origin** - Sets the reference value ranging from -250.00 to 250.00 V. The default setting is 0.00 V.

AMPLITUDE Y Scale Key Menu

NOTE

The Spectrum or Linear Spectrum (for E4406A) window must be active in the **Spectrum** or **Spectrum Linear** (for E4406A) view to access the following **AMPLITUDE Y Scale** key menu:

- **Scale/Div** - Sets the vertical scale by changing an amplitude value per division. The range is 0.10 dB to 20.00 dB per division or 1.00 nV to 20.00 V per division, respectively. The default setting is 10.00 dB or 100.0 mV. However, since the **Scale Coupling** default is **On**, this value is automatically determined by the measurement results. When you set a value manually, **Scale Coupling** automatically changes to **Off**.
- **Ref Value** - Sets the reference value ranging from -250.00 to 250.00 dBm or -250.00 to 250.00 V. The default setting is 0.00 dBm or 0.00 V. However, since the **Scale Coupling** default is **On**, this value is automatically determined by the measurement results. When you set a value manually, **Scale Coupling** automatically changes to **Off**.
- **Ref Position** - Sets the reference position to either **Top**, **Ctr** (center) or **Bot** (bottom). The default setting is **Ctr**.
- **Scale Coupling** - Toggles the scale coupling function between **On** and **Off**. The default setting is **On**. Upon pressing the **Restart** front-panel key or **Restart** softkey under the **Meas Control** menu, this function automatically determines the scale per division and reference values based on the measurement results. When you set a value to either **Scale/Div** or **Ref Value** manually, **Scale Coupling** automatically changes to **Off**.

NOTE The I or Q Waveform window must be active in the **I and Q Waveform** view (**for E4406A**) for the **AMPLITUDE Y Scale** key to access the following menu:

- **Scale/Div** - Sets the vertical scale by changing the amplitude value per division. The range is 1.00 nV to 20.00 V per division. The default setting is 100.0 mV. However, since the **Scale Coupling** default is **On**, this value is automatically determined by the measurement results. When you set a value manually, **Scale Coupling** automatically changes to **Off**.
- **Ref Value** - Sets the reference value ranging from -250.00 to 250.00 V. The default setting is 0.00 V. However, since the **Scale Coupling** default is **On**, this value is automatically determined by the measurement results. When you set a value manually, **Scale Coupling** automatically changes to **Off**.
- **Ref Position** - Sets the reference position to either **Top**, **Ctr** (center) or **Bot** (bottom). The default setting is **Ctr**.
- **Scale Coupling** - Toggles the scale coupling function between **On** and **Off**. The default setting is **On**. The **Restart** front-panel key or **Restart** softkey under the **Meas Control** menu, this function automatically determines the scale per division and reference values by the measurement results. When you set a value to either **Scale/Div** or **Ref Value** manually, **Scale Coupling** automatically changes to **Off**.

NOTE The I/Q Polar window must be active in the **I/Q Polar** view (for E4406A), for the **AMPLITUDE Y Scale** key to access the following menu:

- **I/Q Scale/Div** - Sets the vertical and horizontal scales by changing the value per division. The range is 1.00 nV to 20.00 V per division. The default setting is 100.0 mV.
- **I Origin** or **Q Origin** - Sets the reference value ranging from -250.00 to 250.00 V. The default setting is 0.00 V.

Display Key Menu

The Display Key is not active for this measurement.

Marker Key Menu

- **Select 1 2 3 4** - Activates up to four markers with the corresponding numbers, respectively. The selected number is underlined and its function is defined by pressing the **Function** key. The default is 1.
- **Normal** - Activates the selected marker to read the frequency and amplitude of the marker position on the spectrum trace. Marker position is controlled by the **RPG** knob.
- **Delta** - Reads the differences in frequency and amplitude between the selected marker and the next marker.
- **Function Off** - Selects marker function to be **Band Power**, **Noise**, or **Off**. The default is **Off**. If set to **Band Power**, you need to select **Delta**.
- **Trace Spectrum** - Places the selected marker on the **Spectrum**, **Spectrum Avg**, **Spectrum Linear** (for E4406A), **Spectrum Avg Linear** (for E4406A), **I/Q Waveform**, **I Waveform** (for E4406A), or **Q Waveform** (for E4406A) or **I/Q Waveform** trace. The default is **Spectrum**.
- **Off** - Turns off the selected marker.
- **Shape Diamond** - Accesses the menu to define the selected marker shape to be **Diamond**, **Line**, **Square**, or **Cross**. The default shape is **Diamond**.
- **Marker All Off** - Turns off all of the markers.

Peak Search Key

The front panel Search key performs a peak search when pressed. A marker will automatically be activated at the highest peak.

Waveform (Time Domain) Keys

NOTE You must have selected **Waveform** under the Key Path: **MEASURE** menu to access these menus.

Measurement Setup Key Menu

Key Path: **Meas Setup**

- **Sweep Time** - Specifies the measurement acquisition time which is used as the length of the time capture record. The range is 1.0 μ s and 100.0 s, depending upon the resolution bandwidth setting and the available internal memory size for acquisition points.
- **Meas Time** - Specifies the measurement acquisition time which is used as the length of the time capture record. The range is 10 ns and 100.0 s, depending upon the resolution bandwidth setting and the available internal memory size for acquisition points.
- **Res BW** - Sets the measurement bandwidth. The range is 10 Hz to 8 MHz using the Gaussian filter selected from RBW Filter under the Advanced menu, or 10 Hz to 10 MHz using the Flat top filter selected from RBW Filter. A larger bandwidth results in a larger number of acquisition points and reduces the maximum value allowed for the sweep time.
- **IF BW** - For PSA Option 122 or 140 only. Sets the measurement bandwidth. In wideband operation the range is 10 kHz to 80 MHz.(Option 122) or 10 kHz to 40 MHz (Option 140). The narrowband range is 10 Hz to 10 MHz. A larger bandwidth results in a larger number of acquisition points and reduces the maximum value allowed for the measurement time.
- **Wideband Setup** configures the wideband hardware path. This functionality is only available with the wideband options (122 or 140, PSA only).
 - **Wideband IF Gain** - Sets the gain for the wideband IF path. You must have selected **IF Path Wide**. Increasing the gain can increase the amplitude of small signals as long as you don't overdrive the hardware

- **Wideband Filtering** - Accesses the menu to configure several aspects of the wideband filter.
 - ❑ **Filter Type** - Selects **None** for no filtering, or **Raised Cosine**, **RRC** (root-raised cosine), **Nyquist**, **Root Nyquist**, **Gaussian** and **Flat Top**.
 - ❑ **Filter Alpha** - Selects the filter alpha.
 - ❑ **Filter BW** - Selects filter bandwidth. Bandwidth is not entered as a frequency. The value is entered as a ratio of the current instrument sampling rate (i.e. BW/sample rate).
- **Sample Rate** - Allows arbitrary sample rates with 5 digits of resolution from 12.5 kHz to 100 MHz. Sample rate is coupled with the selected filter shape and bandwidth, and with the maximum available captured data.
- **Block Size** - This key is for information only. Block size is coupled with the IF bandwidth and the measurement time.
- **Wideband Advanced** - Accesses the advanced settings for the Option 122 wideband IF hardware path (PSA only).

NOTE

Parameters under the **Wideband Advanced** key seldom need to be changed. Any changes from the default advanced values may result in invalid measurement data.

- ❑ **ADC Corr** Turning corrections on performs an ADC calibration to reduce the spectral image and applies the corrections.
- ❑ **IF Flat Corr** turns IF flatness corrections on and off for the Option 122 or 140 wideband IF. This control is independent of the narrowband IF flatness control.
- ❑ **Analog Filter** manually selects the 80 MHz (Opt 122), 40 MHz (Opt 140), or 36 MHz anti-alias filter, which overrides the automatic selection of the bandwidth.
- ❑ **WB ADC Dither** Toggles the ADC dither function on/off. The “ADC dither” refers to the introduction of noise to the digitized steps of the analog-to-digital converter; the result is an improvement in amplitude accuracy. The wideband dither control does not affect the ADC dither in the narrowband IF path.
- ❑ **Trig Interp** This is an advanced function that usually does not need to be changed. During normal operation trigger interpolation is on and the trigger offset is 0 seconds. At low sample rates the trigger interpolation can cause hardware unlock errors, so you may want to turn it off. You must have an external trigger source to use this functionality.

- **Average**
 - **Avg Number** - Changes the number of N averages.
 - **Avg Mode** - Toggles the averaging mode between **Exp** (exponential) and **Repeat**. This selection only effects on the averaging result after the number of N averages is reached. The N is set using the **Avg Number** key.
 - **Normal averaging:** Normal (linear) averaging is always used until the specified number of N averages is reached. When the **Measure** key under **Meas Control** is set to **Single**, data acquisition is stopped when the number of N averages is reached, thus **Avg Mode** has no effect in the single measurement mode.
 - **Exponential averaging:** When **Measure** is set to **Cont**, data acquisition will continue indefinitely. Exponential averaging is used with a weighting factor of N (the displayed count of averages stops at N). Exponential averaging weights new data more heavily than old data, which allows tracking of slow-changing signals. The weighting factor N is set using the **Avg Number** key.
 - **Repeat averaging:** When **Measure** is set to **Cont**, data acquisition will continue indefinitely. After the number of N averages is reached, all previous result data is cleared and the average count displayed is set back to 1. This is equivalent to being in **Measure Single** and pressing the **Restart** key each time the single measurement finishes.
 - **Avg Type** - Accesses the menu of the following average types only for making spectrum (frequency domain) and waveform (time domain) measurements:
 - Pwr Avg (RMS)** - Executes the true power averaging which is calculated by averaging the rms voltage. This is the most accurate type.
 - Log-Pwr Avg (Video)** - Simulates the traditional spectrum analyzer type of averaging by calculating the log of the power. This type of averaging will underestimate the power when the signal is noise-like.
 - Voltage Avg** - Executes voltage averaging.
 - Maximum** - Captures peak voltage data. Simulates the traditional spectrum analyzer peak hold function.
 - Minimum** - Captures the minimum voltage data, similar to the maximum function.

- **Time Avg Num** - Changes the number of time averages to be made when using the Option 122 or 140 wideband hardware (PSA only). This averaging requires a frame trigger and is much faster than the standard averaging. This hardware averaging is done on the complex voltage time trace data before any measurement application averaging is done. Both types of averaging can be done on the same measurement data.

When time averaging is being done, each trace update represents N fresh data acquisitions averaged together, where N is the number of averages. You cannot access the individual time records that are being averaged in the hardware averager.

CAUTION If triggering is set incorrectly, averaged signal results can approach nil. “HW Average” is displayed when averaging is ON.

TIP If your measurement results vary or provide unexpected values, try turning Averaging OFF and execute single, non-averaged measurements to check your triggering setup. Press **Meas Control, Measure, Single** to make non-continuous measurements.

- **Trig Source**

Key path: **Meas Setup, Trig Source**

NOTE Changing the selection in the **Trig Source** menu alters the trigger source for the selected measurement only.

- **Free Run (Immediate)** - A trigger occurs at the time the data is requested, completely asynchronous with the RF or IF signal.
- **Video (Envlp)** - An internal IF envelope trigger that occurs at the absolute threshold level of the IF signal level.
- **RF Burst (Wideband)** - An internal wideband RF burst trigger that has the automatic level control for burst signals. It triggers at the level that is set relative to the peak RF signal (12 MHz bandwidth) input level. (Not available for Option 122 or 140 when using the wideband IF path.)
- **Ext Front** - Activates the front panel external trigger input (**EXT TRIGGER INPUT**) port. The external signal must be between -5.00 and $+5.00$ V with 1 or 10 mV resolution.
- **Ext Rear** - Activates the rear-panel external trigger input (**TRIGGER IN**) port. The external signal must be between -5.00 and $+5.00$ V with 1 or 10 mV resolution.

- **Frame** - Uses the internal frame clock to generate a trigger signal. The clock parameters are controlled under the **Mode Setup** key or the measurement firmware, but not both. Refer to the specific measurement section for details.
- **Line** - Sets the trigger to the internal line mode. Sweep triggers occur at intervals synchronous to the line frequency. See the specific measurement section for details.
- **IF Path** Only for PSA with Option B7J and either Option 122 or 140 installed. Selects either the standard narrowband IF hardware path or the wideband hardware path.
- **Restore Meas Defaults** - Presets only the settings that are specific to the selected measurement by pressing **Meas Setup, More (1 of 2), Restore Meas Defaults**. This will set the measure setup parameters, for the currently selected measurement only, to the factory defaults.
- **(Narrowband) Advanced** Accesses the menu to change the following parameters.

CAUTION

The advanced features should be used only if you are familiar with their operation. Changes from the default values may result in invalid data.

The **Narrowband** key label word is only present if you have Option B7J and either Option 122 or 140 installed. Parameters that are under the **(Narrowband) Advanced** key only affect the standard narrow band IF path. The wideband IF advanced functions are found under the **Wideband Advanced** key.

- **Pre-ADC BPF** - Toggles the pre-ADC bandpass filter function between **On** or **Off**. The default setting is **Off**. The pre-ADC bandpass filter is useful for rejecting nearby signals, so that sensitivity within the span range can be improved by increasing the ADC range gain.
- **RBW Filter** - Toggles the resolution bandwidth filter selection between **Flat** and **Gaussian**. If set to **Gaussian**, the filter provides more even time-domain response, particularly for “bursts”. If set to **Flat**, the filter provides a flatter bandwidth but is less accurate for “pulse responses”. A flat top filter also requires less memory and allows longer data acquisition times. For most waveform applications, the Gaussian filter is recommended. The resolution bandwidth range is 10 Hz to 8 MHz using the Gaussian filter or 10 Hz to 10 MHz using the Flat top filter.
- **ADC Range** - Accesses the menu to select one of the ADC ranging functions:
 - Auto** - Automatically adjusts the signal range for optimal measurement results.
 - AutoPeak** - Continuously searches for the highest peak signal.

- AutoPeakLock** - Adjusts the range for the highest peak signal it identifies. It retains the range settings determined by that peak signal, even when the peak signal is no longer present.
- Manual** - Accesses the selection menu of values, -6 to +24 dB for E4406A or None to +18 dB for PSA, to set the ADC range level. Also note that manual ranging is best for CW signals.
- **Data Packing** - Selects **Auto** (the default) or the **Short (16 bit)**, **Medium (24 bit)** and **Long (32 bit)** methods of data packing. The short, medium, and long methods are not compatible with all settings and should not be used unless you are familiar with data packing methods. **Auto** is the preferred choice.
 - Auto** - The data packing value most appropriate for current instrument settings is selected automatically.
 - Short (16 bit)** - Select this to pack data every 16 bits.
 - Medium (24 bit)** - Select this to pack data every 24 bits.
 - Long (32 bit)** - Select this to pack data every 32 bits.
- **ADC Dither** - Toggles the ADC dither function between **On** and **Off**. The default setting is **Off**. If set to **On**, the ADC dither refers to the introduction of noise to the digitized steps of the analog-to-digital converter, and results in better amplitude linearity and resolution in low level signals. However, it also results in reduced dynamic range by approximately 3 dB.
- **Decimation** - Toggles the decimation function between **On** and **Off**, and to set the decimation value. Decimation allows longer acquisition times for a given bandwidth by eliminating data points. Long time captures can be limited by the instrument data acquisition memory. Decimation numbers 1 to 4 describe the factor by which the number of points are reduced. The default setting is 1, which results in no data point reduction.

Table 3-22

Waveform (Time Domain) Measurement Defaults

Measurement Parameter	Factory Default Condition
Sweep Time	2.000 ms 15.00 ms
IFBW	100.000 kHz 500.000 kHz
Averaging: Avg Number Avg Mode Avg Type	10; Off Exp Pwr Avg (RMS)
Trig Source	Free Run (Immediate) RF Burst
IF Path (requires Option B7J and Option 122 or 140)	Narrow
Wideband IF Gain (Option 122 or 140)	0.00 dB
Wideband Filtering (Option 122 or 140) Filter Type Filter Alpha Filter BW	None 0.30 0.50
Signal Envelope View SPAN X Scale - Scale/Div AMPLITUDE Y Scale - Scale/Div	(for E4406A) 200.0 μ s 10.00 dB
RF Envelope View SPAN X Scale - Scale/Div AMPLITUDE Y Scale - Scale/Div	(for PSA) 200.0 μ s 10.00 dB
Linear Envelope View SPAN X Scale - Scale/Div Linear Envelope window: AMPLITUDE Y Scale - Scale/Div Phase window: AMPLITUDE Y Scale - Scale/Div	(for E4406A Option B7C) 200.0 μ s 100.0 mV 30.0 deg
I/Q Waveform View: SPAN X Scale -Scale/Div AMPLITUDE Y Scale - Scale/Div	200.0 μ s 100.0 mV
I and Q Waveform View: SPAN X Scale -Scale/Div AMPLITUDE Y Scale - Scale/Div	(for E4406A Option B7C) 200.0 μ s 100.0 mV
I/Q Polar View: I/Q Scale/Div I or Q Origin	(for E4406A) 100.0 mV 0.00 V
(Narrowband) Advanced	
Pre-ADC BPF	Off

Table 3-22 Waveform (Time Domain) Measurement Defaults

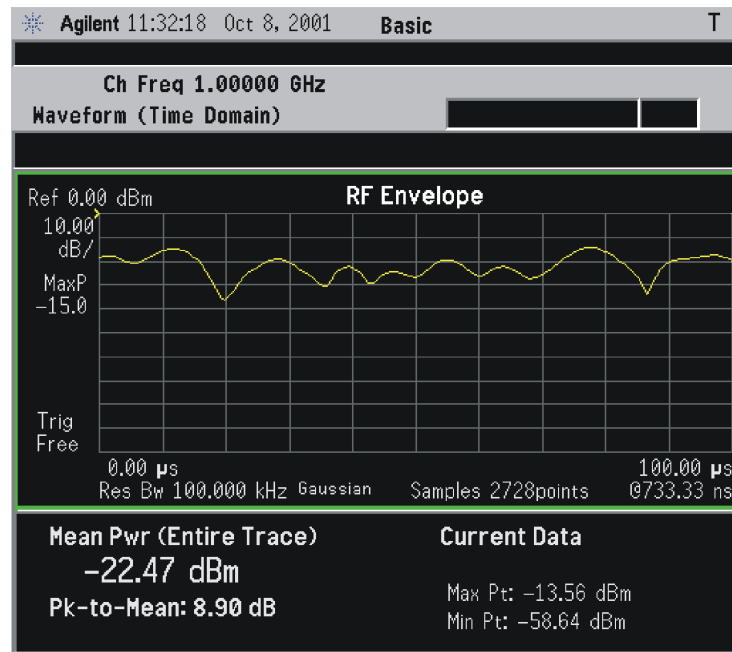
Measurement Parameter	Factory Default Condition
RBW Filter	Gaussian
ADC Range	Auto
Data Packing	Auto
ADC Dither	Off
Decimation	Off
Wideband Advanced (Option 122 or 140)	
ADC Correction	On
IF Flatness Corrections	On
Analog Filter	Auto, 80 MHz (Opt 122), 40 MHz (Opt 140)
WB ADC Dither	On
Trigger Interpolation	On

View/Trace Key Menu

Key Path: **View/Trace**

- **RF Envelope** - Displays a time domain graph of the signal. The measured values for the mean power and peak-to-mean power are shown in the text window.

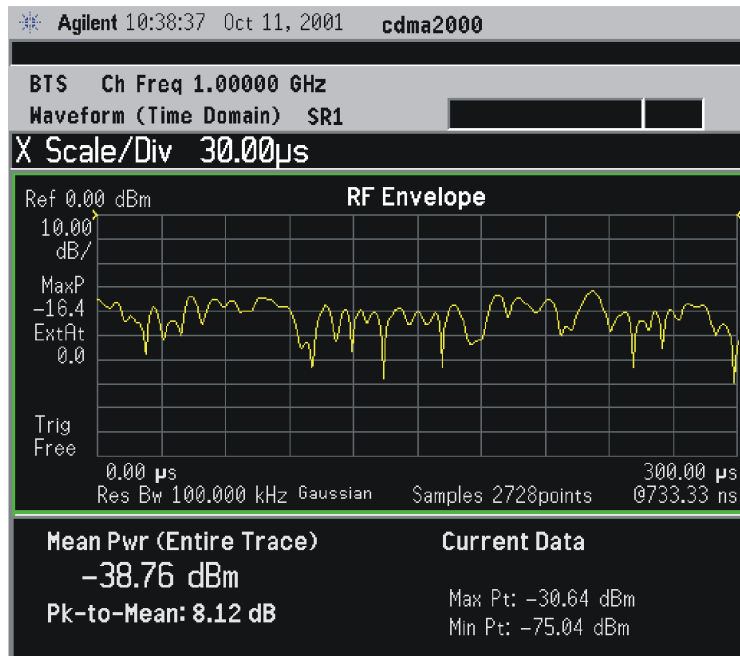
Figure 3-63 Waveform Measurement - RF Envelope (Default View)



*Meas Setup: Trace/View = RF Envelope,
Others = Factory default settings

*Input signal: cdma2000 Rev 8, SR1, 9 Channel

Figure 3-64 Waveform Measurement - RF Envelope (Default View)



*Meas Setup: Trace/View = RF Envelope,
Others = Factory default settings

*Input signal: cdma2000 Rev 8, SR1, 9 Channel

Figure 3-65 Waveform Measurement - RF Envelope (Default View)

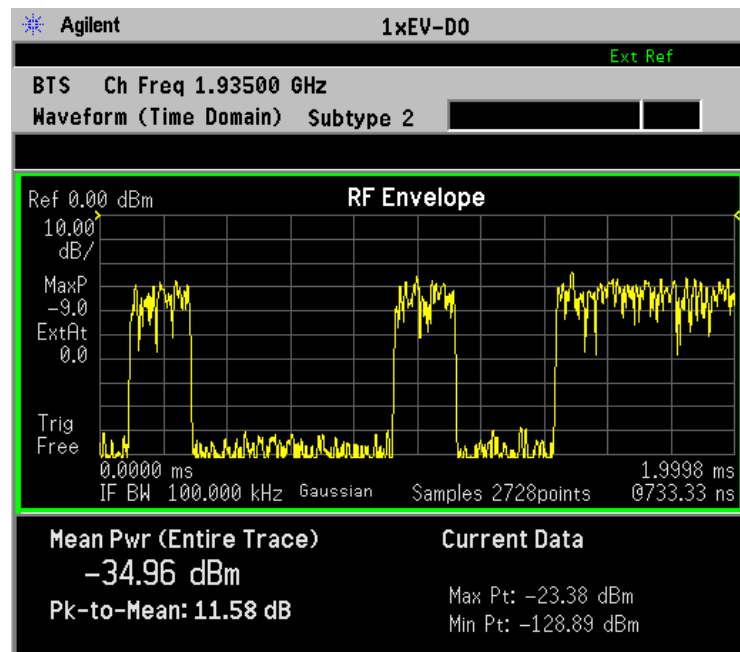
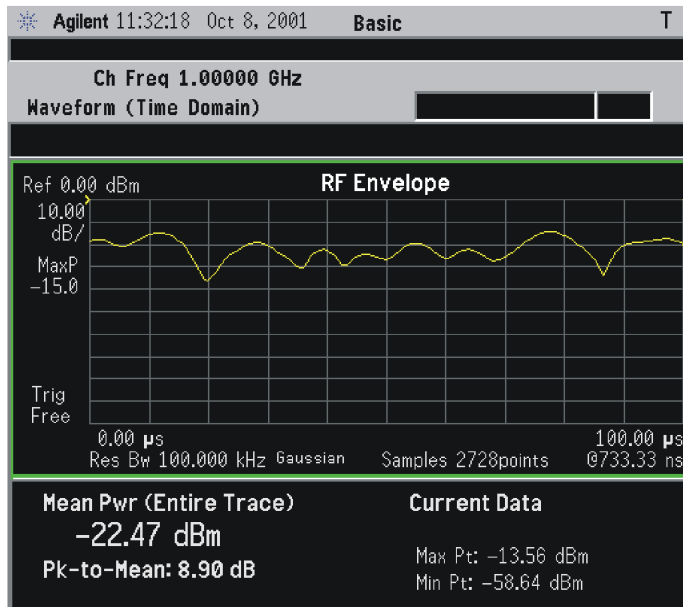
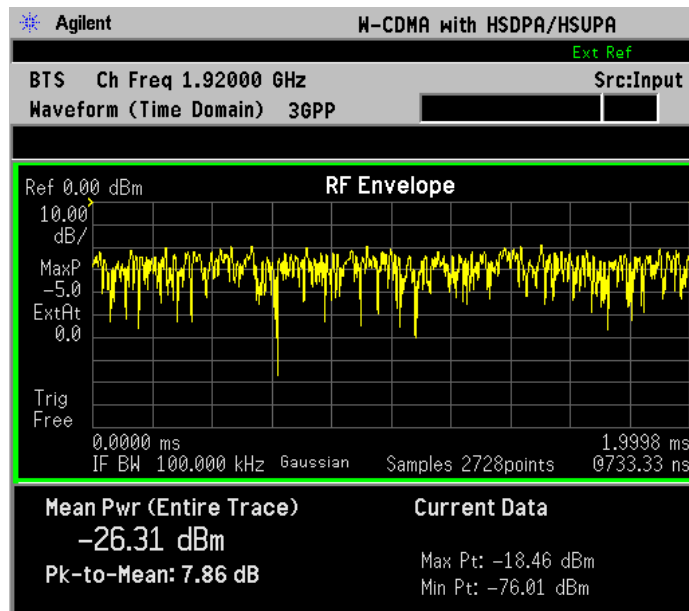


Figure 3-66 Waveform Measurement - RF Envelope (Default View)

*Meas Setup: Trace/View = RF Envelope,
Others = Factory default settings

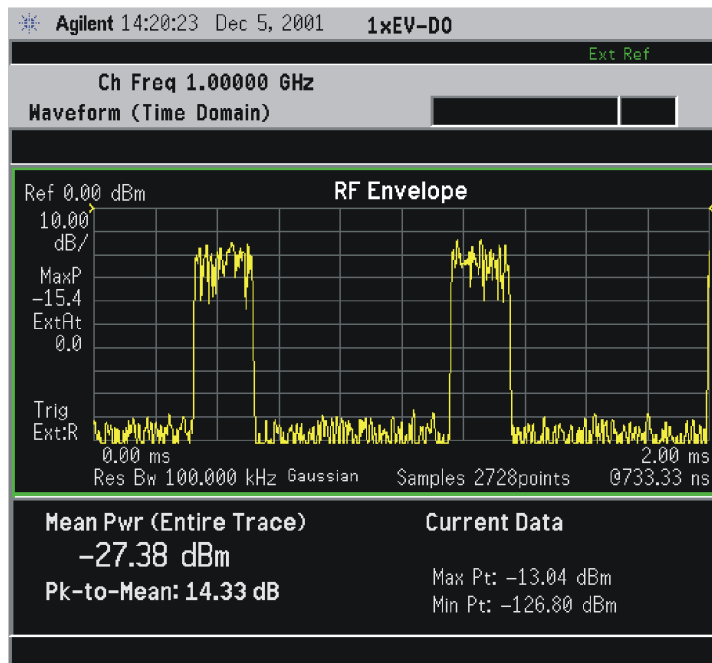
*Input signal: cdma2000 Rev 8, SR1, 9 Channel

Figure 3-67 Waveform Measurement - RF Envelope (Default View)

*Meas Setup: Trace/View = RF Envelope View,
Others = Factory default settings

*Input signal: W-CDMA (3GPP 3.4 12-00), 1 DPCH,

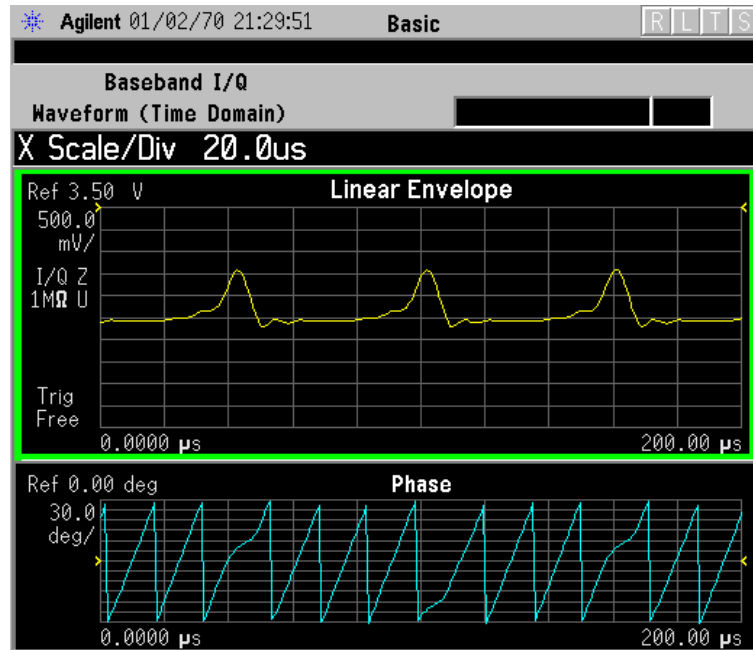
Figure 3-68 Waveform Measurement - RF Envelope (Default View)



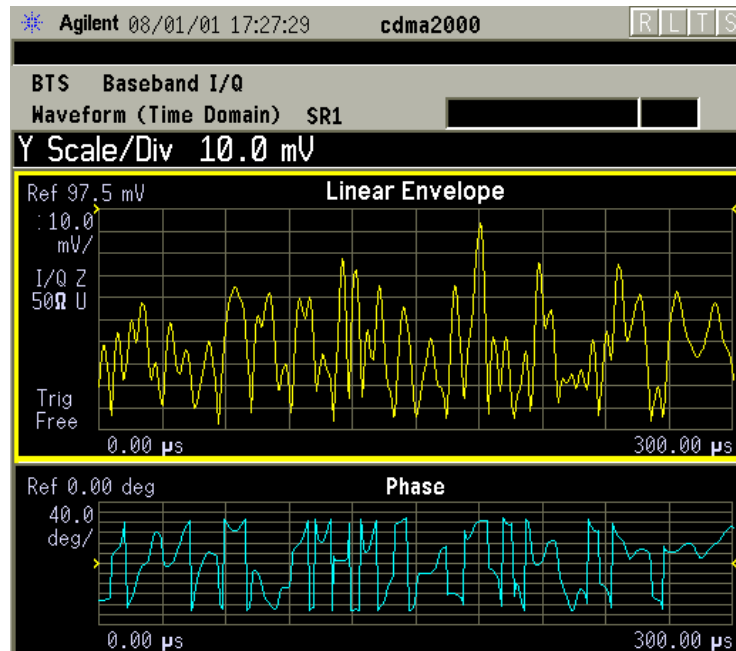
*Meas Setup: View/Trace = RF Envelope,
Trigger Source = Ext Rear,
Others = Factory default settings

*Input signal: -10 dBm, Idle slot, 1xEV-DO

Figure 3-69 Linear Envelope - (for E4406A Option B7C) Provides a combination view of a linear signal envelope graph and a phase graph with linear graticules. Use the **Next Window** and **Zoom** keys to select and enlarge either graph.

Figure 3-70 Waveform Measurement - Linear Envelope View

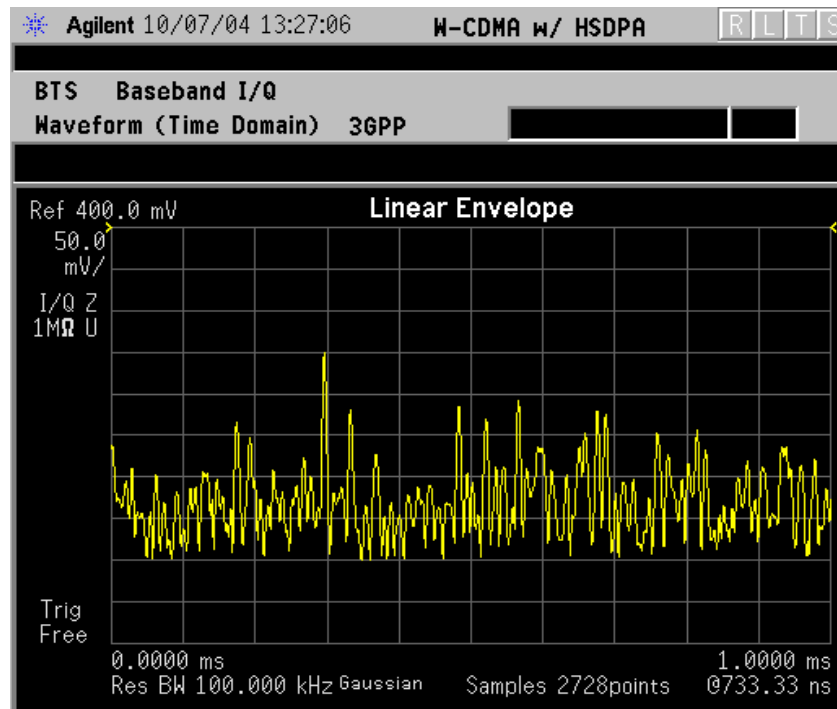
*Meas Setup: View/Trace = Linear Envelope View, GSM signal
Others = Factory defaults, except X and Y scales

Figure 3-71 Waveform Measurement - Linear Envelope View

*Meas Setup: View/Trace = Linear Envelope View,
Others = Factory defaults, except X and Y scales

*Input signal: cdma2000 Rev 8, SR1, 9 Channel

Figure 3-72 Waveform Measurement - Linear Envelope View



*Meas Setup: View/Trace = Linear Envelope View,
Others = Factory defaults, except X and Y scales

*Input signal: W-CDMA (3GPP 3.4 12-00), 1 DPCH,

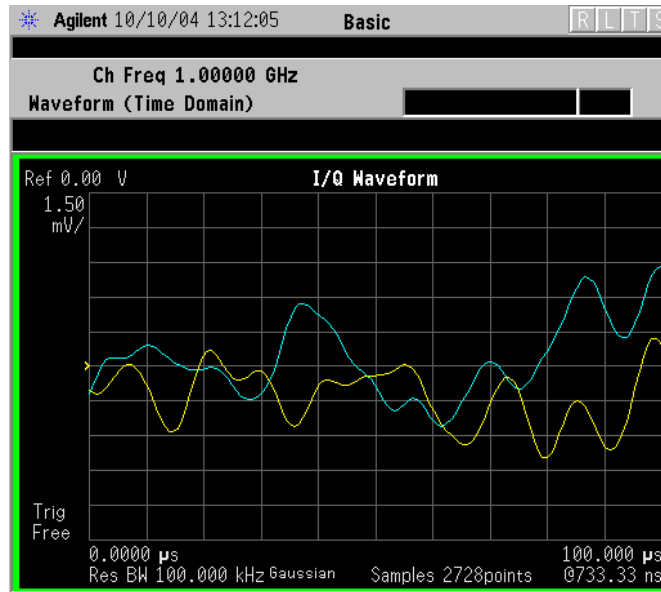
*Meas Setup: View/Trace = Linear Envelope View,
Others = Factory defaults, except X and Y scales

*Input signal: EDGE Standard pattern (4-1's and 4-0's)

Key Reference
W-CDMA Measurement Keys

- **I/Q Waveform** - Provides a view of the I and Q waveforms together on the same graph in parameters of voltage versus time in linear scale. Changes to sweep time or resolution bandwidth can affect data acquisition.

Figure 3-73 Waveform Measurement - I/Q Waveform View



NOTE

For the widest spans, the I/Q Waveform window becomes just “ADC time domain samples”, because the I/Q down-conversion is no longer in effect.

Figure 3-74 Waveform Measurement - I/Q Waveform View

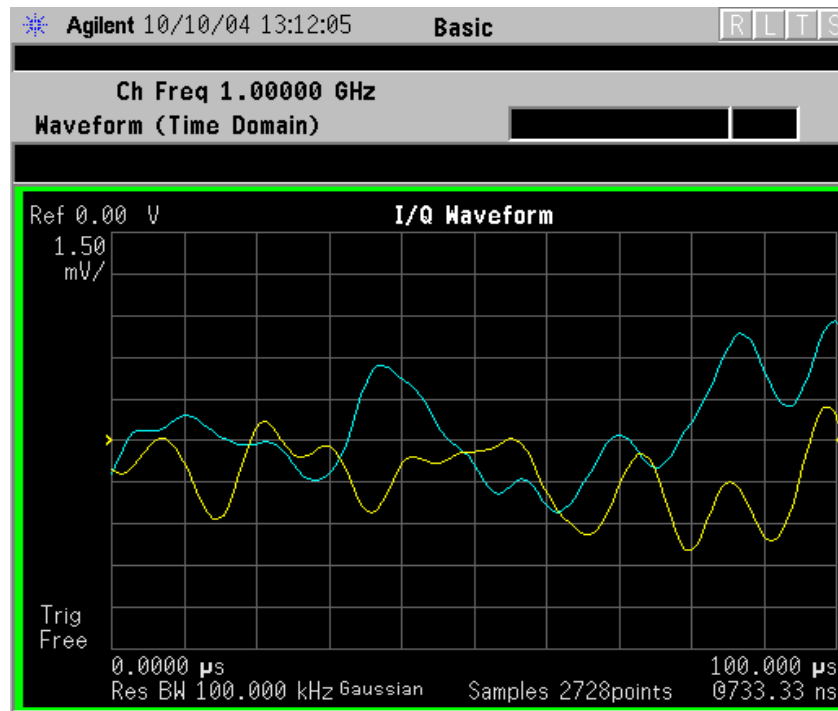
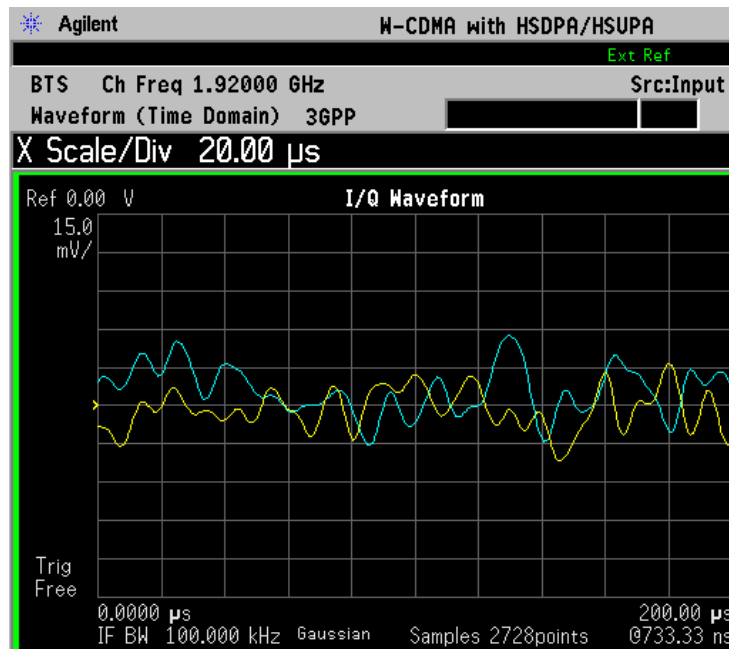


Figure 3-75 Waveform Measurement - I/Q Waveform View

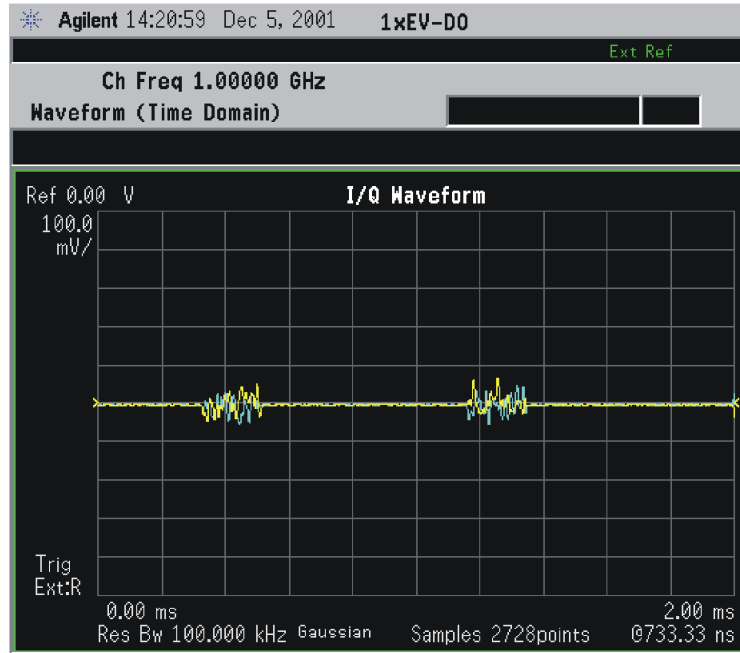


*Meas Setup: View/Trace = Linear Envelope View,
Others = Factory defaults, except X and Y scales

*Input signal: W-CDMA (3GPP 3.4 12-00), 1 DPCH,

NOTE For the widest spans the I/Q Waveform window becomes just “ADC time domain samples”, because the I/Q down-conversion is no longer in effect.

Figure 3-76 Waveform Measurement - I/Q Waveform View



*Meas Setup: View/Trace = I/Q Waveform,
Trigger Source = Ext Rear,
Others = Factory default settings

*Input signal: -10 dBm, Idle slot, 1xEV-DO

- **I and Q Waveform** - (for E4406A Option B7C) Provides a combination view of the I and Q signal waveform graphs in the linear scales.

Figure 3-77 Waveform Measurement - I and Q Waveform View

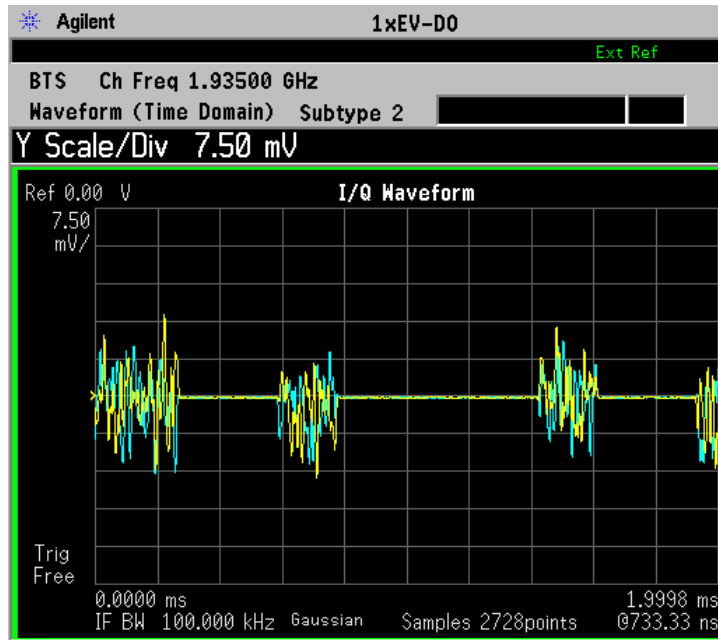


Figure 3-78 Waveform Measurement - I and Q Waveform View

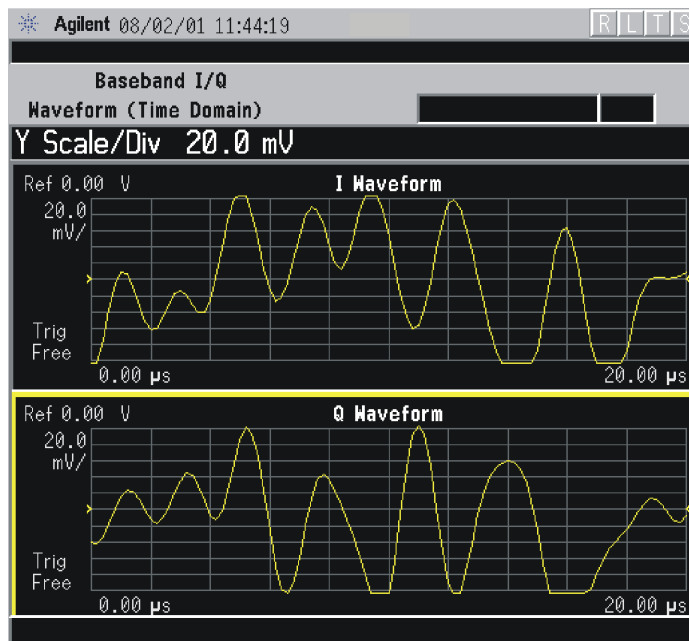
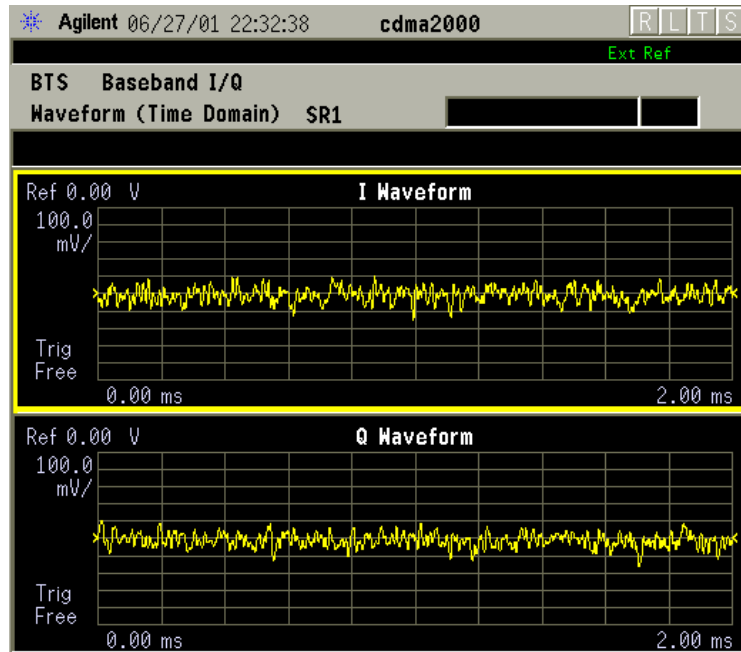
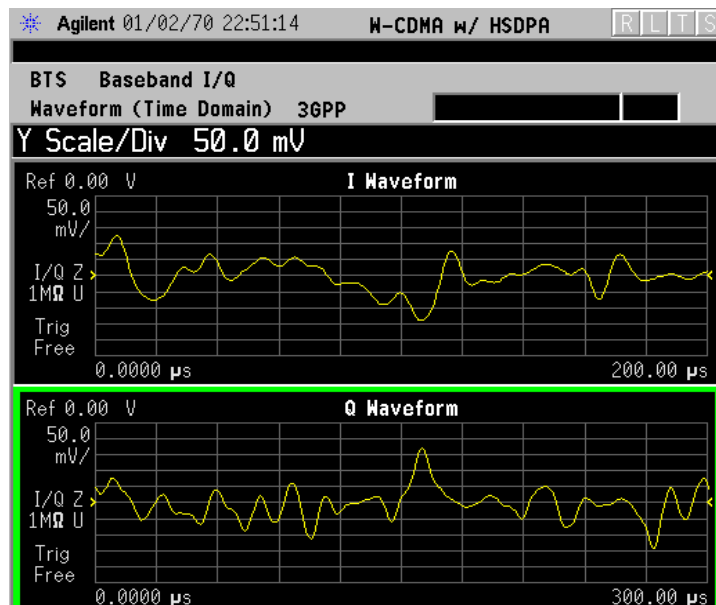


Figure 3-79 Waveform Measurement - I and Q Waveform View

*Meas Setup: View/Trace = I and Q Waveform View,
Others = Factory defaults, except X and Y scales

*Input signal: cdma2000 Rev 8, SR1, 9 Channel

Figure 3-80 Waveform Measurement - I and Q Waveform View

*Meas Setup: View/Trace = I and Q Waveform View,
Others = Factory defaults, except X and Y scales

*Input signal: W-CDMA (3GPP 3.4 12-00), 1 DPCH,

- **I/Q Polar** - (for E4406A) Provides a view of the I/Q signal in a polar vector graph.

Figure 3-81 Waveform Measurement - I/Q Polar View

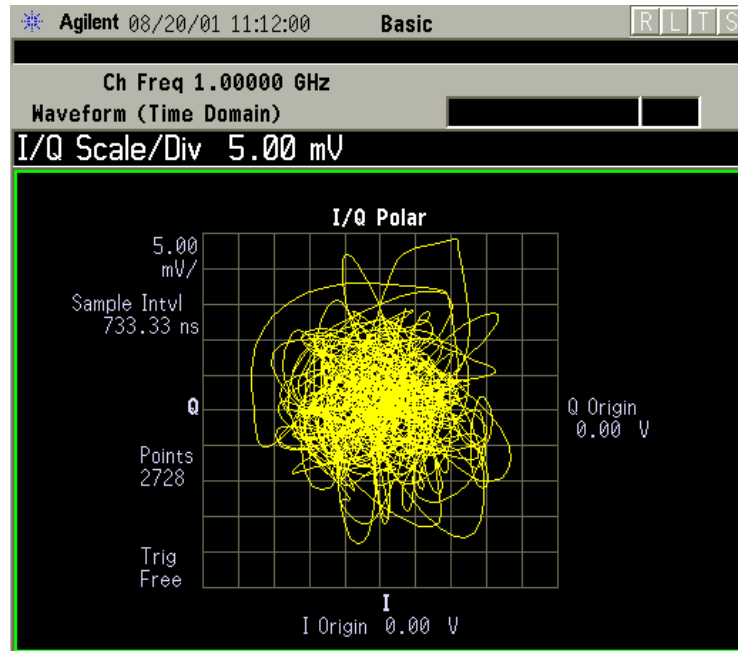
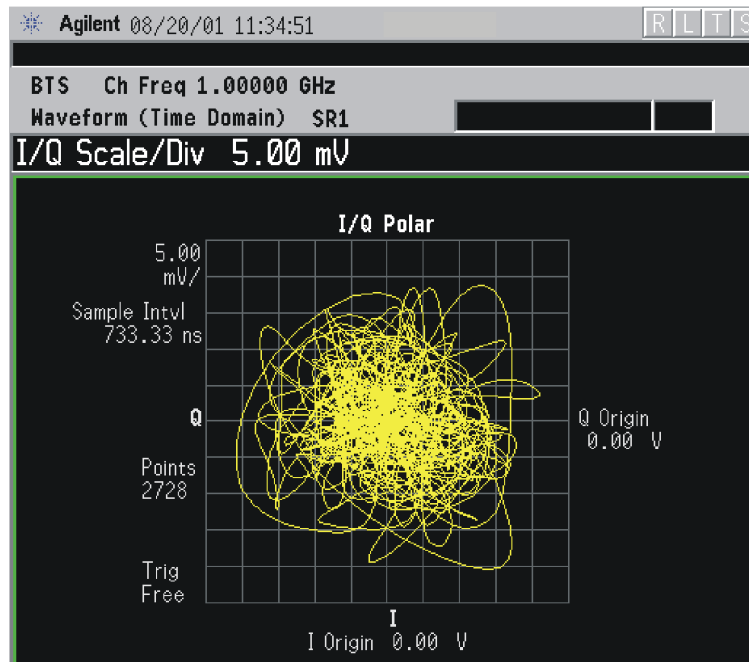
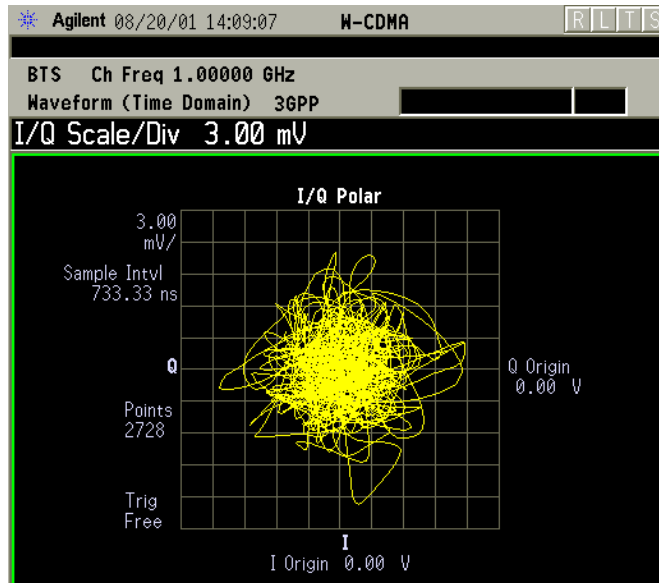


Figure 3-82 Waveform Measurement - I/Q Polar View



*Meas Setup: View/Trace = I/Q Polar View,
Others = Factory defaults, except X and Y scales

*Input signal: cdma2000 Rev 8, SR1, 9 Channel

Figure 3-83 Waveform Measurement - I/Q Polar View

*Meas Setup: View/Trace = I/Q Polar View,
Others = Factory defaults, except X and Y scales

*Input signal: W-CDMA (3GPP 3.4 12-00), 1 DPCH,

Figure 3-84 Waveform Measurement - I/Q Polar View

*Meas Setup: View/Trace = I/Q Polar,
Trigger Source = Ext Rear,
Others = Factory default settings

*Input signal: -10 dBm, Idle slot, 1xEV-DO

- **Trace Display** - Press this key to access the trace selection menu. The currently selected trace type is shown on the **Trace Display** key.
 - **All** - Views both the current trace and the average trace.
 - **Average** - Views only the average trace (in blue color). See the **Meas Setup**, **Average** keys to select different types of averaging.
 - **Current** - Views only the trace (in yellow color) for the latest data acquisition.
 - **I Trace** - (for E4406A) Views only the I signal trace.
 - **Q Trace** - (for E4406A) Views only the Q signal trace.

SPAN X Scale Key Menu

Key Path: **Span X Scale**

NOTE

The **SPAN X Scale** key accesses the menu to modify the horizontal parameters common to the scaled windows for this measurement. Use the **Sweep Time** key under the **Meas Setup** menu to control the horizontal time span for this measurement:

- **Scale/Div** - Sets the horizontal scale by changing a time value per division. The range is 1.0 ns to 1.000 s per division with 0.01 ns resolution. The default setting is 200.0 μ s per division. However, since the **Scale Coupling** default is **On**, this value is automatically determined by the measurement result. When you set a value manually, **Scale Coupling** automatically changes to **Off**.
- **Ref Value** - Sets the reference value ranging from -1.0 to 10.0 s. The default setting is 0.00 s. However, since the **Scale Coupling** default is **On**, this value is automatically determined by the measurement result. When you set a value manually, **Scale Coupling** automatically changes to **Off**.
- **Ref Position** - Sets the reference position to either **Left**, **Ctr** (center) or **Right**. The default setting is **Left**.
- **Scale Coupling** - Toggles the scale coupling function between **On** and **Off**. The default setting is **On**. Upon pressing the **Restart** front-panel key or **Restart** softkey under the **Meas Control** menu, this function automatically determines the scale per division and reference values based on the measurement results. When you set a value to either **Scale/Div** or **Ref Value** manually, **Scale Coupling** automatically changes to **Off**.

NOTE For E4406A, if the I/Q Polar window is active in the **I/Q Polar** view, the **SPAN X Scale** key accesses the following menu:

- **I/Q Scale/Div** - Sets the vertical and horizontal scales by changing a value per division. The range is 1.00 nV to 20.00 V per division. The default setting is 100.0 mV.
- **I or Q Origin** - Sets the reference value ranging from -250.00 to 250.00 V. The default setting is 0.00 V.

AMPLITUDE Y Scale Key Menu

Key Path: **AMPLITUDE Y Scale**

NOTE If the RF Envelope (for PSA) or Signal Envelope (for E4406A) window is active in the **RF Envelope** (for PSA) or **Signal Envelope** (for E4406A) view, the **AMPLITUDE Y Scale** key accesses the following menu:

- **Scale/Div** - Sets the vertical scale by changing an amplitude value per division. The range is 0.10 to 20.00 dB per division with 0.01 dB resolution. The default setting is 10.00 dB per division. However, since the **Scale Coupling** default is **On**, this value is automatically determined by the measurement result. When you set a value manually, **Scale Coupling** automatically changes to **Off**.
- **Ref Value** - Sets the reference value ranging from -250.00 to 250.00 dBm. The default setting is 0.00 dBm. However, since the **Scale Coupling** default is **On**, this value is automatically determined by the measurement result. When you set a value manually, **Scale Coupling** automatically changes to **Off**.
- **Ref Position** - Sets the reference position to either **Top**, **Ctr** (center) or **Bot** (bottom). The default setting is **Top**.
- **Scale Coupling** - Toggles the scale coupling function between **On** and **Off**. The default setting is **On**. Upon pressing the **Restart** front-panel key or **Restart** softkey under the **Meas Control** menu, this function automatically determines the scale per division and reference values based on the measurement results. When you set a value to either **Scale/Div** or **Ref Value** manually, **Scale Coupling** automatically changes to **Off**.

NOTE

For E4406A with Option B7C, if the Linear Envelope window is active in the **Linear Envelope** view, the **AMPLITUDE Y Scale** key accesses the following menu:

- **Scale/Div** - Sets the vertical scale by changing an amplitude value per division. The range is 1.00 nV to 20.00 V per division. The default setting is 100.0 mV per division. However, since the **Scale Coupling** default is **On**, this value is automatically determined by the measurement result. When you set a value manually, **Scale Coupling** automatically changes to **Off**.
- **Ref Value** - Sets the reference value ranging from -250.00 to 250.00 V. The default setting is 0.00 V. However, since the **Scale Coupling** default is **On**, this value is automatically determined by the measurement result. When you set a value manually, **Scale Coupling** automatically changes to **Off**.
- **Ref Position** - Sets the reference position to either **Top**, **Ctr** (center) or **Bot** (bottom). The default setting is **Top**.
- **Scale Coupling** - Toggles the scale coupling function between **On** and **Off**. The default setting is **On**. Upon pressing the **Restart** front-panel key or **Restart** softkey under the **Meas Control** menu, this function automatically determines the scale per division and reference values based on the measurement results. When you set a value to either **Scale/Div** or **Ref Value** manually, **Scale Coupling** automatically changes to **Off**.

NOTE

For E4406A with Option B7C, if the Phase window is active in the **Linear Envelope** view, the **AMPLITUDE Y Scale** key accesses the menu to modify the following parameters:

- **Scale/Div** - Sets the vertical scale by changing an amplitude value per division. The range is 0.10 to 3600.0 deg per division. The default setting is 30.00 deg. However, since the **Scale Coupling** default is **On**, this value is automatically determined by the measurement result. When you set a value manually, **Scale Coupling** automatically changes to **Off**.
- **Ref Value** - Sets the reference value ranging from -36000.0 to 36000.0 deg. The default setting is 0.00 deg. However, since the **Scale Coupling** default is **On**, this value is automatically determined by the measurement result. When you set a value manually, **Scale Coupling** automatically changes to **Off**.
- **Ref Position** - Sets the reference position to either **Top**, **Ctr** (center) or **Bot** (bottom). The default setting is **Ctr**.

Key Reference
W-CDMA Measurement Keys

- **Scale Coupling** - Toggles the scale coupling function between **On** and **Off**. The default setting is **On**. Upon pressing the **Restart** front-panel key or **Restart** softkey under the **Meas Control** menu, this function automatically determines the scale per division and reference values based on the measurement results. When you set a value to either **Scale/Div** or **Ref Value** manually, **Scale Coupling** automatically changes to **Off**.

NOTE

If the I/Q Waveform window is active in the **I/Q Waveform** view (or the I Waveform, or Q Waveform window is active in the **I and Q Waveform** view for E4406A with Option B7C), the **AMPLITUDE Y Scale** key accesses the menu to modify the following parameters:

- **Scale/Div** - Sets the vertical scale by changing an amplitude value per division. The range is 1.00 nV to 20.00 V per division. The default setting is 100.0 mV. However, since the **Scale Coupling** default is **On**, this value is automatically determined by the measurement result. When you set a value manually, **Scale Coupling** automatically changes to **Off**.
- **Ref Value** - Sets the reference value ranging from -250.00 to 250.00 V. The default setting is 0.00 V. However, since the **Scale Coupling** default is **On**, this value is automatically determined by the measurement result. When you set a value manually, **Scale Coupling** automatically changes to **Off**.
- **Ref Position** - Sets the reference position to either **Top**, **Ctr** (center) or **Bot** (bottom). The default setting is **Ctr**.
- **Scale Coupling** - Toggles the scale coupling function between **On** and **Off**. The default setting is **On**. Upon pressing the **Restart** front-panel key or **Restart** softkey under the **Meas Control** menu, this function automatically determines the scale per division and reference values based on the measurement results. When you set a value to either **Scale/Div** or **Ref Value** manually, **Scale Coupling** automatically changes to **Off**.

NOTE

For E4406A, if the I/Q Polar window is active in the **I/Q Polar** view, the **SPAN X Scale** or **AMPLITUDE Y Scale** key accesses the menu to modify the following parameters:

- **I/Q Scale/Div** - Sets the vertical and horizontal scales by changing a value per division. The range is 1.00 nV to 20.00 V per division. The default setting is 100.0 mV.
- **I or Q Origin** - Sets the reference value ranging from -250.00 to 250.00 V. The default setting is 0.00 V.

Display Key Menu

The **Display** key is not available for this measurement.

Marker Key Menu

Key Path: **Marker**

The **Marker** front-panel key accesses the menu to configure the markers.

- **Select 1 2 3 4** - Activates up to four markers with the corresponding numbers, respectively. The selected number is underlined and its function is defined by pressing the **Function** key. The default is 1.
- **Normal** - Activates the selected marker to read the time position and amplitude of the marker on the RF envelope or Signal Envelope trace. Marker position is controlled by the **RPG** knob.
- **Delta** - Reads the differences in frequency and either time position or amplitude, between the selected marker and the next marker.
- **Function Off** - Selects the marker function to be **Band Power**, **Noise**, or **Off**. The default is **Off**. If set to **Band Power**, you need to select **Delta**.
- **Trace** - Places the selected marker on **RF Envelope** (for PSA), **Signal Envelope** (for E4406A), or **I/Q Waveform**. Also, for E4406A with Option B7C, you can place the marker on **Linear Envelope**, **Linear Phase**, **I Waveform**, or **Q Waveform**.
- **Off** - Turns off the selected marker.
- **Shape Diamond** - Accesses the menu to define the selected marker shape to be **Diamond**, **Line**, **Square**, or **Cross**. The default shape is **Diamond**.
- **Marker All Off** - Turns off all of the markers.

Peak Search Key

Key Path: **Search**

The front panel **Search** key performs a peak search when pressed. A marker will automatically be activated at the highest peak.

NOTE

In the Waveform measurement, the Mean Pwr (Entire Trace) value plus the Pk-to-Mean value will sum to equal the current Max Pt. value as shown in the data window below the RF Envelope or Signal Envelope display. If you do a marker peak search (**Search**) with averaging turned off, the marker will find the same maximum point. However, if you turn averaging on, the Pk-to-Mean value will use the highest peak found for any acquisition during averaging, while the marker peak will look for the peak of the display, which is the result of n-averages. This will usually result in differing values for the maximum point.

Baseband I/Q Inputs (Option B7C) Keys

Input Port Key Menu

Key Path: **Mode Setup, Input**

Option B7C adds a softkey menu that lets you select I/Q inputs. This menu is located under the **Input/Output** front-panel key. To select an input connector press Input/Output, or **Input Port** under **Mode Setup**. Select the desired input connector(s) from the following choices displayed:

- **RF** - Press to select the 50 Ω N-type RF connector.
- **I/Q** - Select if using 2-connector “unbalanced” or 4-connector “balanced” I/Q connections. Complete your selection by choosing the appropriate input impedance and connectors in the section “[I/Q Input Z Key Menu](#)” on page 389.
- **I only** - Select if using I and/or \bar{I} input connectors (available in the Basic mode). Complete your selection by choosing the appropriate input impedance and connectors in the section “[I/Q Input Z Key Menu](#)” on page 389.
- **Q only** - Select if using Q and/or \bar{Q} input connectors (available in the Basic mode). Complete your selection by choosing the appropriate input impedance and connectors in the section “[I/Q Input Z Key Menu](#)” on page 389.
- **50 MHz Ref** - Select to view the 50 MHz CW calibration signal (signal level is approximately -25.0 dBm).
- **IF Align** - Select to view the IF alignment signal. This signal is available as a diagnostic function, to check the operation of the alignment signal in the case of alignment failure. Once selected, a menu accessing the IF alignment signal parameters is available at the bottom of the **Input** menu. Either CW, comb, or pulse signals may be selected. Because the alignment signal is input at the IF frequency, it is displayed on any active Spectrum (Freq Domain) window, regardless of center frequency.
- **Baseband Align Signal** - Select **On** to view the baseband alignment signal. This is available as a diagnostic function, to check the operation of the alignment signal in the case of alignment failure. Because the alignment signal is input at the IF frequency, it is displayed on any Spectrum (Freq Domain) window.

I/Q Setup Key Menu

Key Path: **Mode Setup, Input**

- **I Offset** - Use to enter a voltage value to offset the measured I value. The default value is 0.0000 V. The range is -2.5600 to +2.5600 V. The tuning increment depends on the **I/Q Range** setting as shown in [Table 3-23](#). This value only affects the displayed results, and does not appear as a correcting voltage at the probe.

Table 3-23

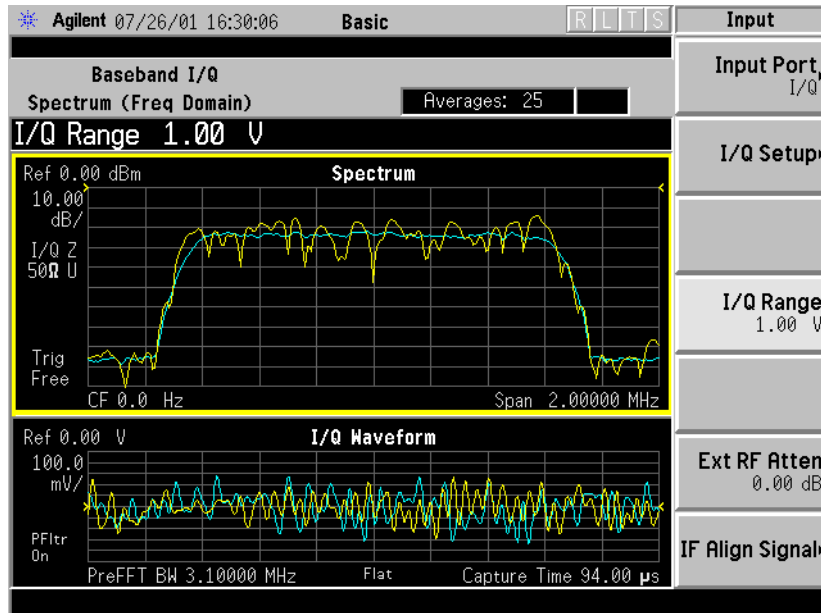
I and Q Offset Increment vs. I/Q Range

I/Q Range	I and Q Offset Increment
1 V	2 mV
500 mV	1 mV
250 mV	.5 mV
125 mV	.25 mV

- **Q Offset** - Use to enter a voltage value to offset the measured Q value. The default value is 0.0000 V. The range is -2.5600 to +2.5600 V. The tuning increment depends on the **I/Q Range** setting as shown in [Table 3-23](#). This value only affects the displayed results, and does not appear as a correcting voltage at the probe.
- **I/Q Input Z** - Allows you to access a menu to select an input impedance for baseband I/Q input signals. The selection of input impedance is coupled to a connector “balance” configuration. If **I/Q Input Z** is set to 1 M Ω , the setting for **I/Q Z Ref for Input Z = 1 M Ω** key becomes effective. For details, refer to [“I/Q Input Z Key Menu” on page 389](#).
- **I/Q Z Ref for Input Z = 1 M Ω** - Allows you to select the 1 M Ω input reference Z value in Ohms. This key is effective only when **I/Q Input Z** is set to a 1 M Ω setting. The default value is 50.0 Ω . The range is 1.0 Ω to 10 M Ω , with a tuning increment of 1.0 Ω . For more details, refer to [“I/Q Input Z Key Menu” on page 389](#).

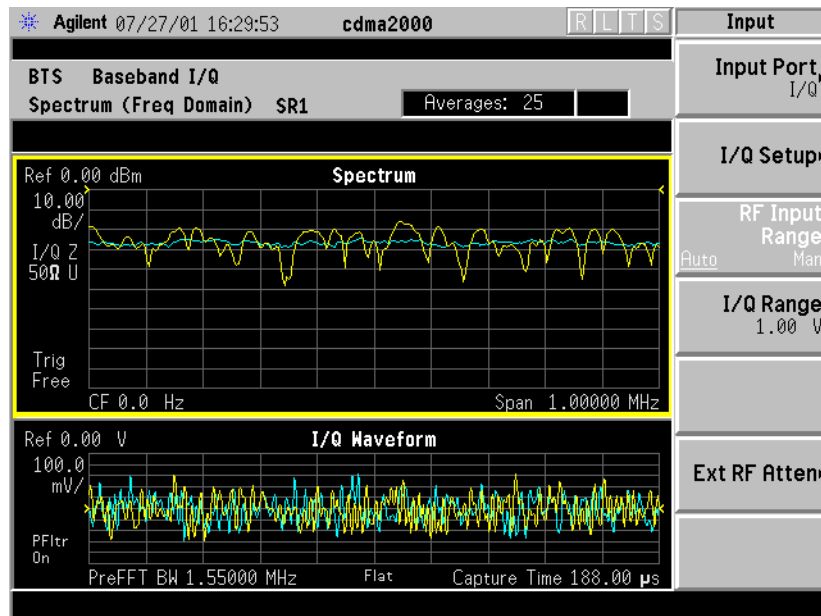
Key Reference
Baseband I/Q Inputs (Option B7C) Keys

Figure 3-85 Input Menu with Option B7C Baseband I/Q Inputs



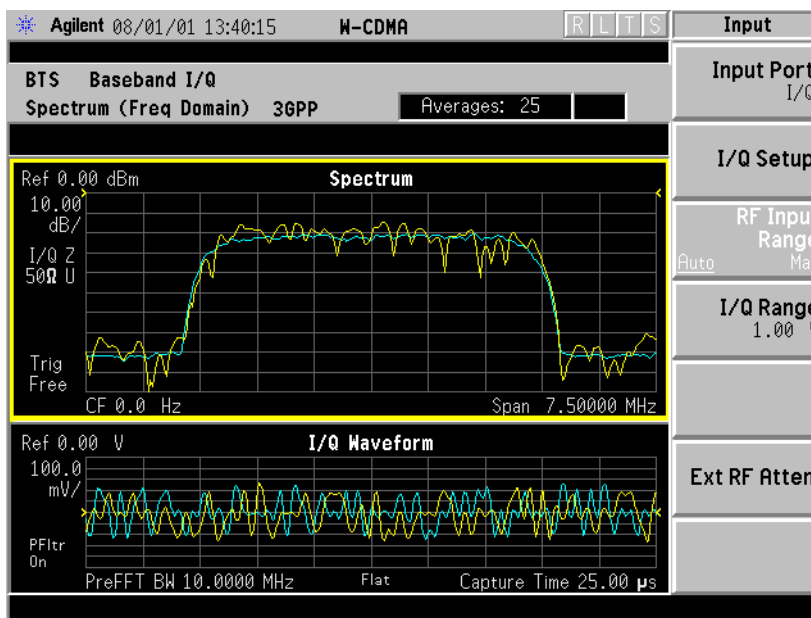
cdma2000 (Rev.8) Downlink, SR1 9 Channel, Baseband I/Q Inputs

Figure 3-86 Input Menu with Option B7C Baseband I/Q Inputs



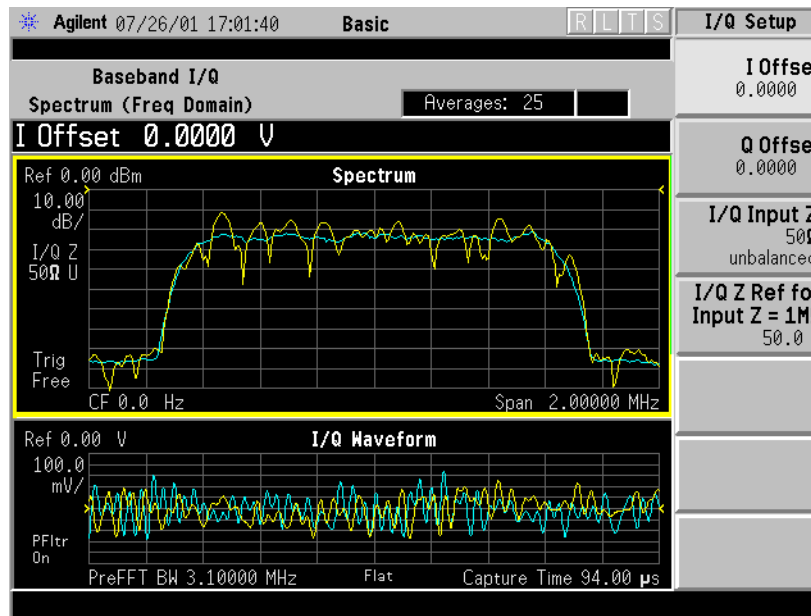
cdma2000 (Rev.8) Downlink, SR3 9 Channel, Baseband I/Q Inputs

Figure 3-87 Input Menu with Option B7C Baseband I/Q Inputs Installed



W-CDMA (3GPP 3.4 12-00) Downlink, 1 DCPH, Baseband I/Q Inputs

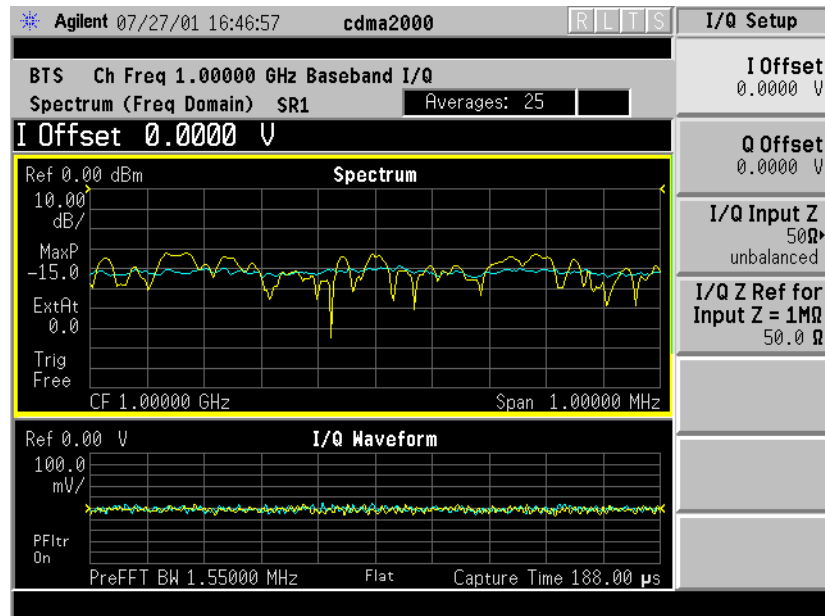
Figure 3-88 I/Q Setup Menu with Option B7C Baseband I/Q Inputs



cdma2000 (Rev.8) Downlink, SR1 9 Channel, Baseband I/Q Inputs

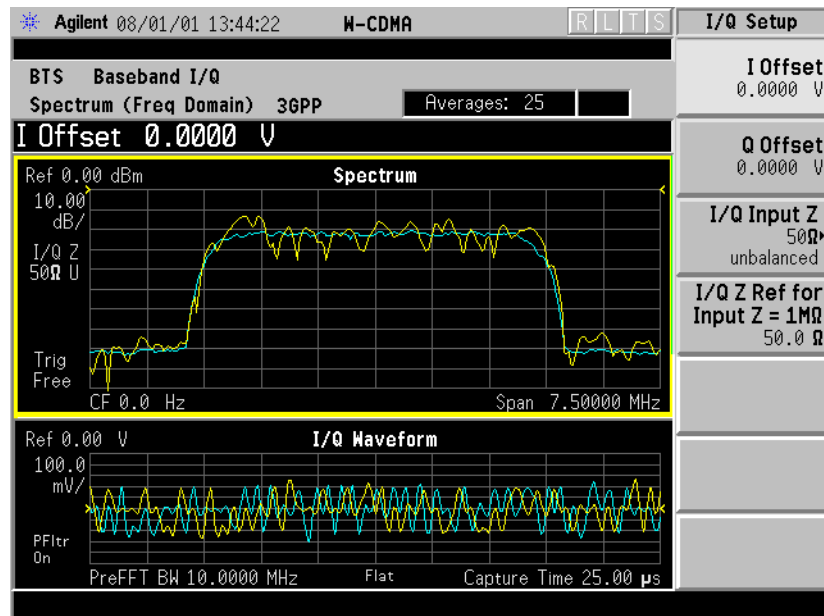
Key Reference
Baseband I/Q Inputs (Option B7C) Keys

Figure 3-89 I/Q Setup Menu with Option B7C Baseband I/Q Inputs



cdma2000 (Rev.8) Downlink, SR3 9 Channel, Baseband I/Q Inputs

Figure 3-90 I/Q Setup Menu with Option B7C Baseband I/Q Inputs



W-CDMA (3GPP 3.4 12-00) Downlink, 1 DCPH, Baseband I/Q Inputs

I/Q Input Z Key Menu

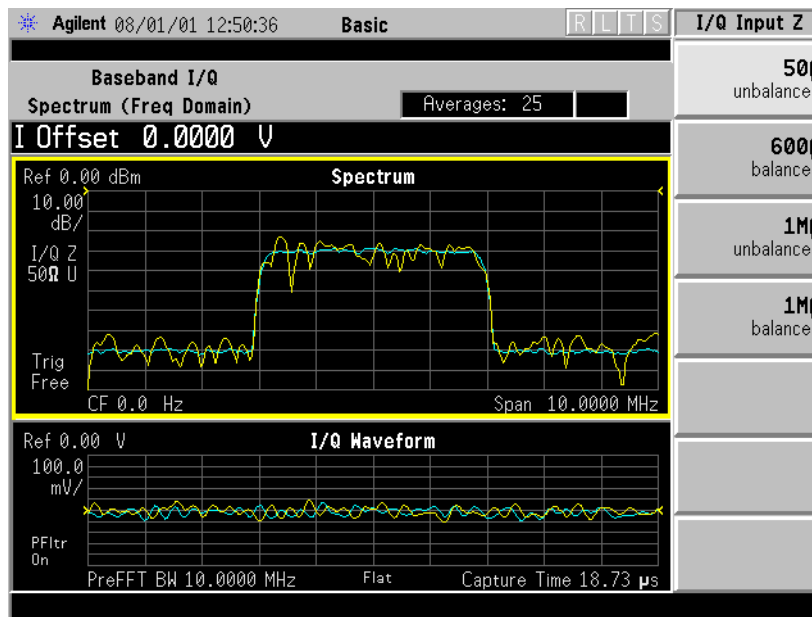
Key Path: Mode Setup, Input, I/Q Setup

To select an input impedance, press **Input/Output**, **I/Q Setup**, **I/Q Input Z** to display the following menu:

- **50 Ω Unbalanced** - Select to use I and/or Q input connectors.
- **600 Ω Balanced** - Select to use either I and \bar{I} , Q and \bar{Q} , or all four I, Q, \bar{I} , and \bar{Q} input connectors.
- **1 M Ω Unbalanced** - This is the default input connector setting. Select to use I and/or Q input connectors in an unbalanced mode. When **I/Q Input Z** is set to 1 M Ω (either balanced or unbalanced), the setting for **I/Q Z Ref for Input Z = 1 M Ω** key may be adjusted. Otherwise, the default value for **I/Q Z Ref = 1 M Ω** is 50 Ω .
- **1 M Ω Balanced** - Select to use either I and \bar{I} , Q and \bar{Q} , or all four I, Q, \bar{I} , and \bar{Q} input connectors to make a balanced measurement. When **I/Q Input Z** is set to 1 M Ω (either balanced or unbalanced), the setting for **I/Q Z Ref for Input Z = 1 M Ω** key may be adjusted. Otherwise, the default value for **I/Q Z Ref for Input Z = 1 M Ω** is 50 Ω .

You can select **I only** or **Q only** in the **Input Port** menu under **Mode Setup** or **Input/Output** with any impedance selection.

Figure 3-91 I/Q Input Z Menu - Option B7C Baseband I/Q Inputs

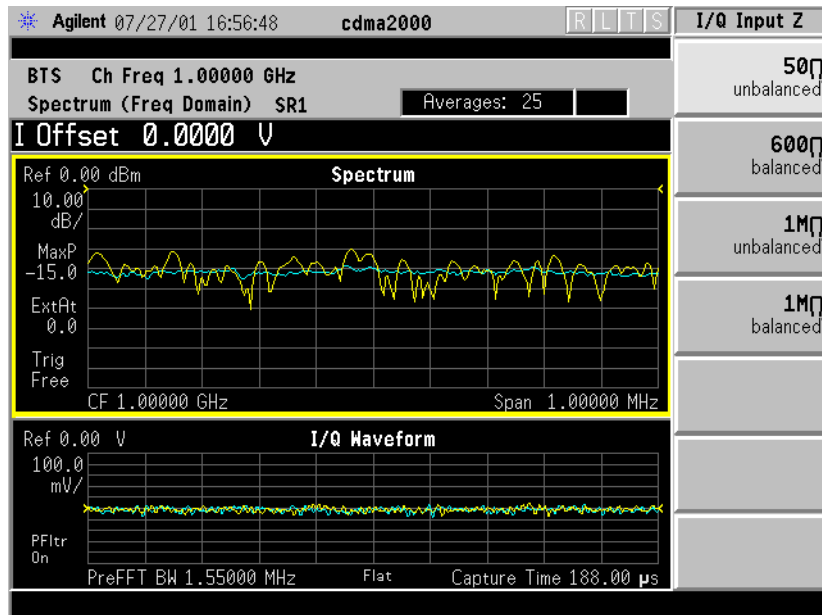


cdma2000 (Rev.8) Downlink, SR1 9 Channel, Baseband I/Q Inputs

Key Reference
Baseband I/Q Inputs (Option B7C) Keys

Figure 3-92

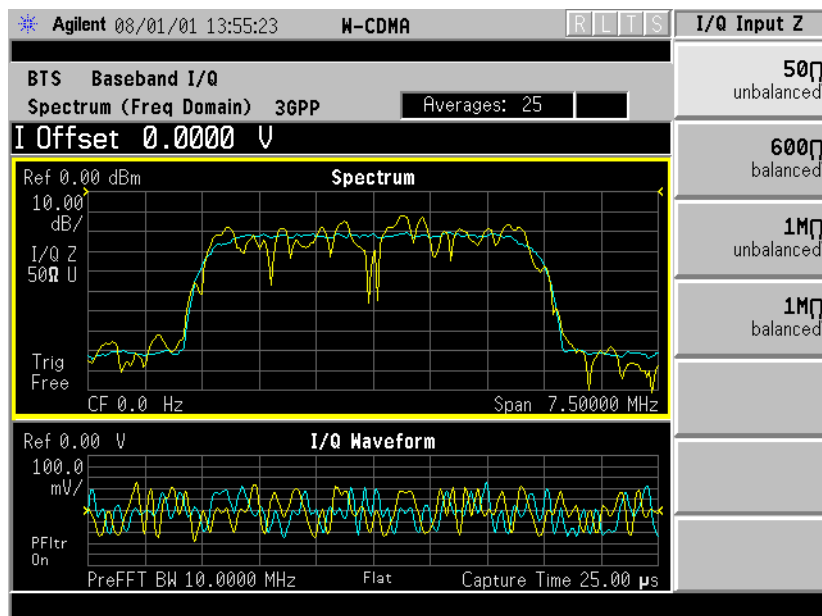
I/Q Input Z Menu - Option B7C Baseband I/Q Inputs



cdma2000 (Rev.8) Downlink, SR3 9 Channel, Baseband I/Q Inputs

Figure 3-93

I/Q Input Z Menu - Option B7C Baseband I/Q Inputs



W-CDMA (3GPP 3.4 12-00) Downlink, 1 DCPH, Baseband I/Q Inputs

I/Q Range Key Menu

NOTE You must have I/Q selected under Key Path: Mode Setup, Input, Input Port to make this menu available

Key Path: Mode Setup, Input

The **I/Q Range** key lets you select one of four levels as an upper limit for the signal being applied to the baseband I/Q inputs. The level may be selected in units of dBm, dBmV, dB μ V, V, and W. The following table shows the four-level selections available for each unit of measure: The default is 1 V.

The **I/Q Range** power levels in [Table 3-24](#) are based on an **I/Q Input Z** of 50 Ω . **I/Q Range** voltage levels are independent of **I/Q Input Z**.

Table 3-24 I/Q Range Settings by Displayed Unit of Measure

Unit of Measure	Highest Setting			Lowest Setting
dBm	13.0	7.0	1.0	-5.1
dBmV	60	54	48	41.9
dB μ V	120.0	114.0	108	101.9
V	1.000	500 m	250 m	125 m
W	20.0 m	5.0 m	1.2 m	310.0 μ

If **I/Q Range** is set below the default and the error message “Input Overload” is displayed, this value may be adjusted to its maximum. Beyond that point, the signal must be attenuated to preserve the measurement accuracy. Using a lower value than the default can provide an increased dynamic measurement range.

Baseband I/Q Key Access Locations

All baseband I/Q input setup and operation features can be located by using the key access table below. The key access path shows the key sequence you enter to access a particular key.

Some features can only be used when specific measurements are active. If a feature is not currently valid the key label for that feature appears as lighter colored text or is not displayed at all.

Table 3-25

Baseband I/Q Key Access Locations

Key	Key Access Path
Align IQ	System>Alignments>Align Subsystem>
Baseband Align Signal	Mode Setup>Input>Input Port>
dBm	Input/Output>I/Q Range>
dBm	Mode Setup>Input>I/Q Range>
dBmv	Input/Output>I/Q Range>
dBmv	Mode Setup>Input>I/Q Range>
dBuv	Input/Output>I/Q Range>
dBuv	Mode Setup>Input>I/Q Range>
I and Q Waveform	View/Trace> (Waveform Measurement)
I Offset	Input/Output>I/Q Setup>
I Offset	Mode Setup>Input>I/Q Setup>
I only	Input/Output>Input Port>
I only	Mode Setup/Input>Input Port>
I/Q	Input/Output>Input Port>
I/Q	Mode Setup>Input>Input Port>
I/Q Input Z	Input/Output>I/Q Setup>
I/Q Input Z	Mode Setup>Input>I/Q Setup>
I/Q Polar	View/Trace>
I/Q Range	Input/Output>
I/Q Range	Mode Setup>Input>
I/Q Setup	Input/Output>
I/Q Setup	Mode Setup>Input>
I/Q Waveform	View/Trace>
I/Q Waveform	Marker>Trace>

Table 3-25 Baseband I/Q Key Access Locations

Key	Key Access Path
I/Q Z Ref for Input Z = 1 MΩ	Mode Setup>Input>I/Q Setup>
I Waveform	View/Trace> (Spectrum Measurement)
Linear Envelope	View/Trace> (Waveform Measurement)
Q Offset	Input/Output>Input>I/Q Setup>
Q Offset	Mode Setup>Input>I/Q Setup>
Q only	Input/Output>Input Port>
Q only	Mode Setup>Input>Input Port>
Q Waveform	Marker>Trace>
Signal Envelope	View/Trace> (Waveform Measurement)
Spectrum Linear	View/Trace> (Spectrum Measurement)
V(olts)	Mode Setup>Input>I/Q Setup>I Offset (or Q Offset)>Keypad Entry
Volts	Input/Output>I/Q Range>
Volts	Mode Setup>Input>I/Q Range>
Watts	Input/Output>I/Q Range>
Watts	Mode Setup>Input>I/Q Range>

Key Reference
Baseband I/Q Inputs (Option B7C) Keys

4 Concepts

This chapter provides details about the W-CDMA communications system, including HSDPA/HSUPA signals, and explains how the various measurements are performed by the instrument. Suggestions for optimizing and troubleshooting your setup are provided, along with a list of related documents that are referenced for further information.

What Is the W-CDMA Communications System?

Wideband code division multiple access (W-CDMA) is a popular air interface technology for third generation RF cellular communications systems. In W-CDMA (3GPP), the cells operate asynchronously, which makes the mobile synchronization more complex, but offers the advantage of flexibility in placement of the base stations. Both reverse and forward transmitter power controls are implemented with 0.625 ms intervals. W-CDMA is a direct sequence spread-spectrum digital communications technique that supports wider RF bandwidths, typically from 5 to 20 MHz. The main advantages of W-CDMA over other types of communication schemes are:

- greater capacity
- immunity to signal loss and degradation due to high-level broadband interference, multipath, scattering, and fading
- power consumption of mobile stations (UE) is strictly minimized by both base station and mobile controls
- supports variable data rates up to 144 kbits/second for mobile (vehicular) data rate, up to 384 kbits/second for portable (pedestrian) data rate, and up to 2 Mbits/second for fixed installations
- provides increased security

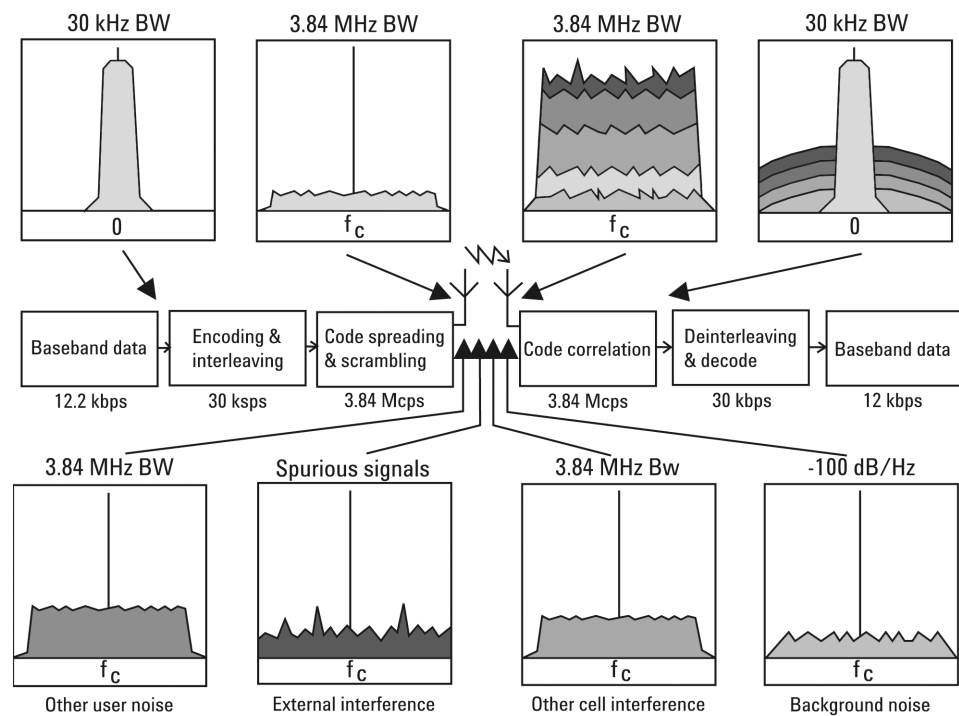
W-CDMA uses correlative codes to distinguish one user from another. Frequency division is still used, as is done with Frequency Division Multiple Access (FDMA) and Time Division Multiple Access (TDMA), but in a much larger bandwidth such as 5 MHz or greater. An initial baseband data rate is spread to a transmitted bit rate of 3.840 Mcps, which is also called chip rate or spread data rate. W-CDMA realizes increased capacity from 1:1 frequency reuse and sectored cells. The capacity limit is soft. That is, capacity can be increased with some degradation of the error rate or voice quality.

W-CDMA Code Division Multiple Access

As its name implies, W-CDMA is a code division multiple access (CDMA) system. As opposed to time division multiple access (TDMA), in CDMA, all users transmit at the same time. Frequency divisions are still used, but at a much larger bandwidth. In addition, multiple users share the same frequency carrier. Each user's signal uses a unique code that appears to be noise to all except the correct receiver. Therefore, the term channel describes a combination of carrier frequency and code. Correlation techniques allow a receiver to decode one signal among many that are transmitted on the same carrier at the same time. [Figure 4-1 on page 397](#) shows a simplified version of the transmission and reception processes for a W-CDMA system. One difference between W-CDMA and earlier existing 2G CDMA systems (like IS-95) is that W-CDMA uses a wider bandwidth (3.84 MHz, as opposed to 1.23 MHz for IS-95).

Figure 4-1

W-CDMA Transmission and Reception Processes



In W-CDMA, a single user's channel consists of a specific frequency combined with a unique code. Correlative codes allow each user to operate in the presence of substantial interference. The interference is the sum of all other users on the same W-CDMA frequency, both from within and outside of the home cell, and from delayed versions of these signals. It also includes the usual thermal noise and atmospheric disturbances. Delayed signals caused by multipath are separately received and combined in W-CDMA. Unlike access in non-CDMA systems, any W-CDMA frequency can be used in all sectors of all cells.

Concepts

The W-CDMA system starts with a narrowband signal at a data rate of 12.2 kbps. In reality, this data rate is variable, up to 2 Mbps. After coding and interleaving, the resulting symbol rate in this example is 30 kbps. This is spread with the use of specialized codes to a bandwidth of 3.84 MHz. The final spread bits are called chips, and the final spread rate is defined in terms of chips per second (3.84 Mcps for W-CDMA). The ratio of the spread data rate (3.84 Mcps) to the encoded data rate (30 kbps in this case) is called the spreading gain. The ratio of the spread data rate to the initial data rate (12.2 kbps in this case) is called the processing gain (overall coding gain). In CDMA systems the spreading gain is a big contributor to the processing gain. The processing gain allows the receiver's correlator to extract the desired signal from the noise. When transmitted, a CDMA signal experiences high levels of interference, dominated by the signals of other CDMA users. This takes two forms, interference from other users in the same cell and interference from adjacent cells. The total interference also includes background noise and other spurious signals. When the signal is received, the correlator recovers the desired signal and rejects the interference. This is possible because the interference sources are uncorrelated to each channel's unique code. In W-CDMA, the unique code for each channel is a combination of the scrambling code and the orthogonal variable spreading factor (OVSF) code, which are described in the following sections.

Base Station and User Equipment Identification

As in other CDMA systems, in W-CDMA each base transceiver station (BTS) output signal is “scrambled” by multiplying all of its data channels by a unique pseudonoise (PN) code, referred to in the W-CDMA specification as a scrambling code. The UE receiver can distinguish one BTS from another by correlating the received signal spectrum with a scrambling code that is identical to that used in the desired BTS. Similarly, each UE output signal is scrambled with a unique scrambling code that allows the BTS receiver to discern one UE from another. The scrambling codes are applied at a fixed rate of 3.840 Mcps. The scrambling codes are not orthogonal, therefore, some interference can exist between two UEs.

Data Channelization

Beside distinguishing which transmitter is being listened to, a CDMA receiver must further distinguish between the various channels originating from that transmitter. For example, a BTS will transmit unique channels to many mobile users, and each UE receiver must distinguish each of its own channels from all the other channels transmitted by the BTS. In W-CDMA, this function is provided by the channelization codes, also known as OVSF codes.

OVSF codes are orthogonal codes similar to the Walsh codes used in IS-95 and cdma2000. Each channel originating from a W-CDMA BTS or UE is multiplied by a different OVSF code¹. In IS-95, Walsh codes are fixed at 64 chips in length; in W-CDMA, the length of these codes, also known as the spreading factor (SF), can be configured from 4 to 512 chips, with the resulting downlink (DL) symbol rate being equal to the system chip rate of 3.84 Mcps divided by the SF. For example a SF of four corresponds to a symbol rate of 960 kspss.

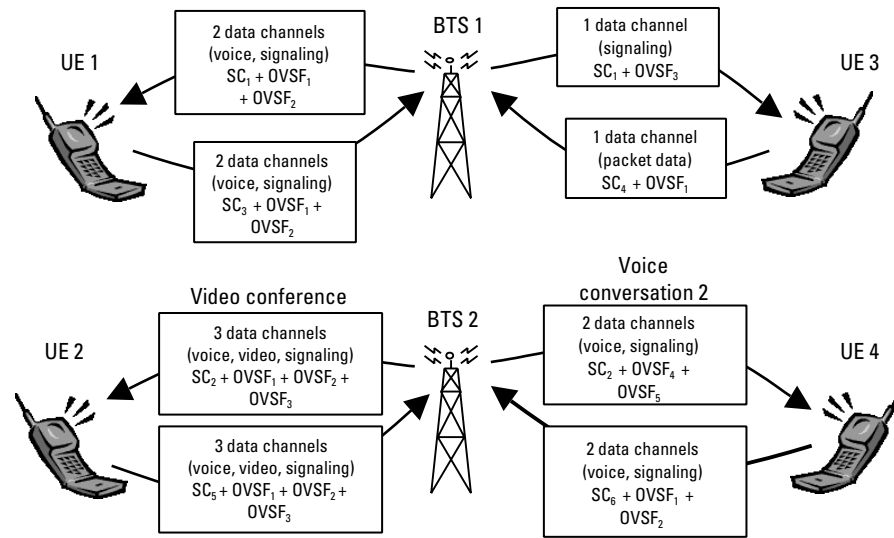
The entire set of OVSF codes is identical for each UE and BTS. The scrambling code allows OVSF code reuse among UE and BTS within the same geographic location. Therefore, it is the combination of OVSF and scrambling codes that provides a unique communication channel between a UE and BTS.

The W-CDMA radio link between the BTS and UE must support multiple simultaneous data channels. For example, a 3G connection may include bi-directional voice, video, packet data, and background signaling messages, each representing a unique data channel within a single frequency carrier.

[Figure 4-2 on page 401](#) illustrates a W-CDMA system with two BTS and four UEs. The scrambling code (SC) provides a unique identity to each UE and each BTS. The OVSF code allocations provide a unique identity to each channel conveyed by a UE or BTS within one cell. For example SC2 identifies BTS 2, and SC6 identifies UE 4. BTS 2 uses OVSF4 and OVSF5 to send voice and signaling information to UE 4. This UE uses OVSF1 and OVSF2 to send voice and signaling information back to BTS 2. Note that other BTSs and UEs also use the same OVSF codes (OVSF1 and OVSF2). This is not a problem since the scrambling codes decorrelate the re-used OVSF codes.

1. The synchronization channels are an exception to this, as described later.

Figure 4-2 W-CDMA Code Allocations



The combination of OVSF codes and scrambling codes provide the signal spreading, and therefore, the spreading gain needed for the receiver correlators to pull the desired signal out of the noise. The SF determines the degree of spreading gain. For high data rate signals, the SF and spreading gain are lower. For the same level of interference, the amplitude for high data rate channels must be higher, in order for all channels to maintain equal energy-per-bit-to-noise ratio (E_b/N_0).

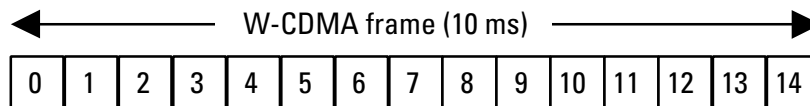
SFs may be reassigned as often as every 10 ms. This allows the W-CDMA network to dynamically reassign bandwidth that would otherwise be wasted. In effect, the total data capacity within W-CDMA can be allocated in a more efficient manner as compared with 2G CDMA systems (IS-95) that use fixed-length orthogonal codes.

W-CDMA Slots, Frames, and Power Control

All W-CDMA uplink (UL) and DL data channels are segmented into time slots and frames. A slot is 666.667 μ sec in length, equal in duration to 2560 chips of the system chip rate. Fifteen of these time slots are concatenated to form a 10 ms frame (see [Figure 4-3 on page 402](#)). The frame is the fundamental unit of time associated with channel coding and interleaving processes. However, certain time-critical information, such as power control bits, are transmitted in every time slot. This facilitates UE power control updates at a rate of 1500 adjustments per second to optimize cell capacity.

Figure 4-3

W-CDMA Slot and Frame Structure



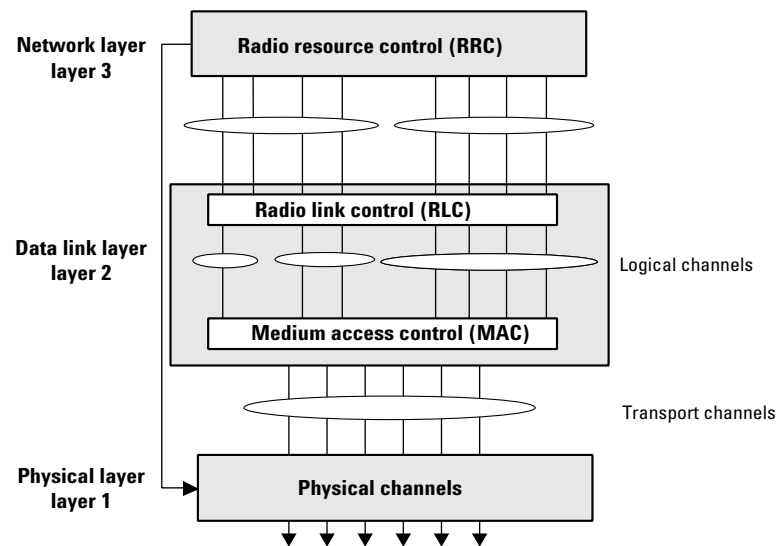
In any cellular CDMA system, the BTS must precisely control the transmit power of the UEs at a rate sufficient to optimize the link budget. This is referred to as UL power control. The goal is to balance the power received at the BTS from all UEs within a few dB, which is essential to optimizing the UL spread spectrum link budget. Unlike IS-95, the UE sends power control bits to the BTS at the same rate, and the BTS responds by adjusting the power of the data channels that are intended for the respective UE. This is referred to as DL power control.

Protocol Structure

The protocol structure of the W-CDMA system closely follows the industry standard open system interconnection (OSI) model. shows the three bottom layers.

Figure 4-4

W-CDMA Protocol Structure



The network layer (layer 3) is based heavily on GSM standards. It is responsible for connecting services from the network to UE. The data link layer (layer 2) is composed of two main functional blocks: the radio link control (RLC) and medium access control (MAC) blocks. The RLC block is responsible for the transfer of user data, error correction, flow control, protocol error detection and recovery, and ciphering. The

MAC function at layer 2 is responsible for mapping between logical channels and transport channels (see following section). This includes providing for the multiplexing/de-multiplexing of various logical channels onto the same transport channel.

The physical layer (layer 1) maps the transport channels onto the physical channels and performs all of the RF functions necessary to make the system work. These functions include operations such as frequency and time synchronization, rate matching, spreading and modulation, power control, and soft handoff.

Logical Transport and Physical Channels

Logical channels are the information content, which will ultimately be transmitted over the physical channels. Logical channels include the Broadcast Control Channel (BCCH), the Paging Control Channel (PCCH), the Common Control Channel (CCCH), and Dedicated Control and Traffic Channels (DCCH, DTCH).

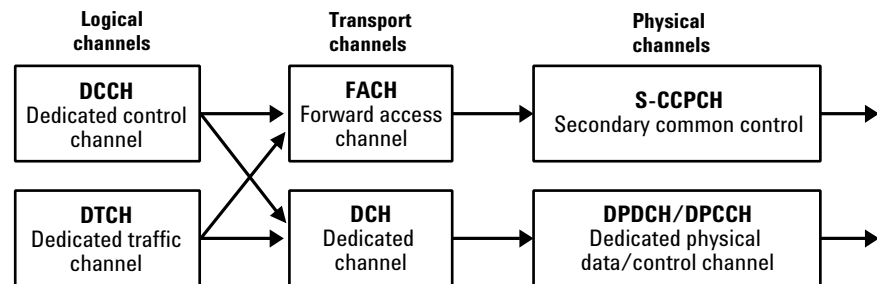
W-CDMA introduces the concept of transport channels to support sharing physical resources between multiple services. Each service, such as data, fax, voice, or signaling, is routed into different transport channels by the upper signaling layers. These services may have different data rates and error control mechanisms. The transport channels are then multiplexed as required prior to transmission via one or more physical channels. High data rate services or a combination of lower rate transport channels may be multiplexed into several physical channels. This flexibility allows numerous transport channels (services) of varying data rates to be efficiently allocated to physical channels. By multiplexing these transport channels efficiently, system capacity is optimized. For example, if the aggregate data rate of three transport channels exceeds the maximum of a single physical channel, then the data can be routed to two lower rate physical channels that closely match the total required data rate. Transport channels include the Broadcast Channel (BCH), the Paging Channel (PCH), the Forward Access Channel (FACH), the Dedicated Channel (DCH), the HSDPA High-Speed Downlink Shared Channel (HS-DSCH, which corresponds to the HS-PDSCH) and the Random Access Channel (RACH). [7]

The W-CDMA DL is composed of a number of physical channels. The most important DL physical channels are the Common Pilot Channel (CPICH), the Primary Common Control Physical Channel (P-CCPCH), the Secondary Common Control Physical Channel (S-CCPCH), the Dedicated Physical Data and Control Channels (DPDCH/DPCCH), the HSDPA High-Speed Physical Downlink Shared Channel (HS-PDSCH), and the HSDPA Shared Control Channel (HS-SCCH). The UL consists of a Physical Random Access Channel (PRACH), a Physical Common Packet Channel (PCPCH), Dedicated Physical Data and

Control Channels (DPDCH/DPCCH), and the HSDPA Dedicated UL Physical Control Channel (HS-DPCCH). The W-CDMA channels above are described in the following sections. For more information on HSDPA channels see [“HSDPA Concepts” on page 419](#).

Figure 4-5 on page 405 shows an example of channel mapping for the DL. When a UE is in the idle mode, the BTS sends dedicated signaling information from the DCCH logical channel through the FACH transport channel. This maps the information onto the S-CCPCH physical channel for transmission to a UE. When the UE is in the dedicated connection mode, the same signaling information is routed through the DCH transport channel. This maps the information onto the DPDCH/DPCCH physical channel for transmission to the UE.

Figure 4-5

Example of Logical, Transport, and Physical Channel Mapping

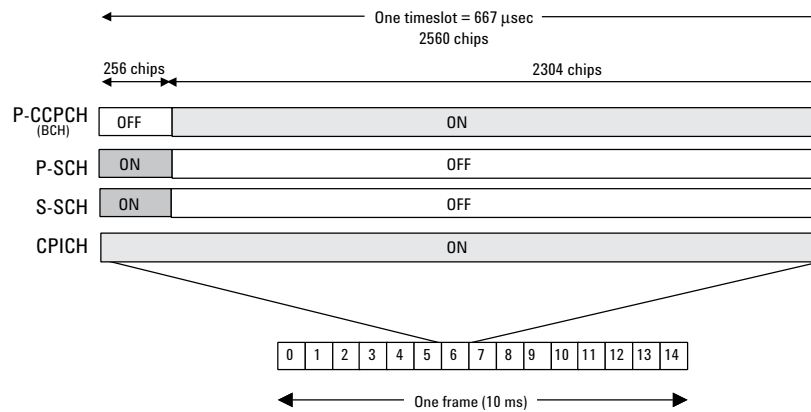
Downlink Physical Channels

Figure 4-6 shows the slot and frame structure for the CPICH, P-CCPCH and SCH.

The CPICH is a continuous loop broadcast of the BTS scrambling code. As described earlier, the scrambling code provides identification of the BTS transmission. The UE uses the CPICH as a coherent reference for precise measurement of the BTS time reference, as well as to determine the signal strength of surrounding BTS before and during cell site handover. Since no additional spreading is applied to this signal, it is quite easy for the UE to acquire a lock to this reference. This must occur before any other channels can be received.

Figure 4-6

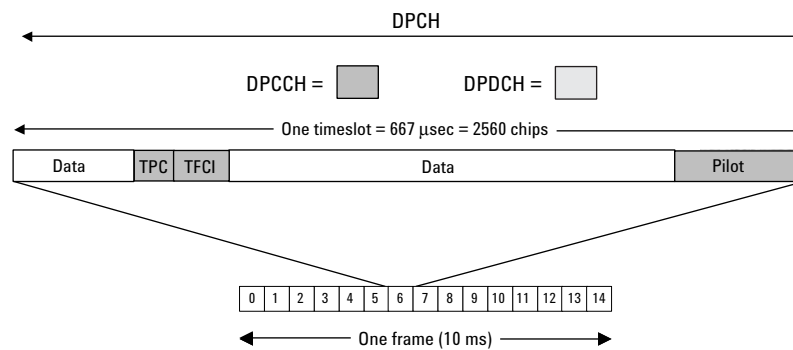
CPICH, P-CCPCH, and SCH Slot and Frame Structure



The P-CCPCH is time multiplexed with an important channel used by the UE during system acquisition, the Synchronization Channel (SCH). This carries two sub-channels, the Primary Synchronization Channel (P-SCH) and Secondary Synchronization Channel (S-SCH). These channels consist of two codes known as Primary Synchronization Code (PSC) and Secondary Synchronization Code (SSC). The PSC is a fixed 256-chip code broadcast by all W-CDMA BTS. During initial acquisition, the UE uses the PSC to determine if a W-CDMA BTS is present and establish the slot boundary timing of the BS. The SSC represents a group, called a code group, of 16 sub-codes, each with a length of 256 chips. The BTS transmits these codes in an established order, one SSC sub-code in each time slot of a frame. When a UE decodes 15 consecutive SSC transmissions, it can determine the BTS frame boundary timing, as well as derive information that will aid in the identification of the BTS scrambling code (see chapter 2). The SCH is transmitted during the first 256 chips of each time slot while the P-CCPCH is off Figure 4-6. During the remaining 2304 chips of each slot the P-CCPCH is transmitted, which contains 18 bits of broadcast data (Broadcast Transport Channel (BCH) information) at a rate of 15 kbps. Since the cell's broadcast parameters message will require more than 18 bits, the broadcast information may span several frames.

The Dedicated Physical Channel (DPCH) carries all the user data and user signaling, as well as physical channel control bits for the slot format and the UE inner loop power control. The DPCH consists of the DPDCH and the DPCCH (Figure 4-7). The user's digitized voice and/or digital data, along with layer 3 signaling data, are carried on the DPDCH. The user data and signaling data are individually treated with error protection coding and interleaving, then multiplexed together to form the DPDCH. The DPDCH is then multiplexed with the DPCCH, which contains the Transmit Power Control (TPC) bits (to control the UE transmit power), Transport Format Combination Indicator (TFCI) bits (indicates the slot format and data rate), and embedded Pilot bits (short synchronization patterns embedded within each slot).

Figure 4-7 DPCH (DPDCH/DPCCH) Slot and Frame Structure



Other DL channels include the Secondary Common Control Physical Channel (S-CCPCH), used to transmit pages and signaling to idling UEs; the Acquisition Indication Channel (AICH), used to acknowledge UE access requests; a Paging Indication Channel (PICH), used to alert the UE of a forthcoming page message; a Physical Downlink Shared Channel (PDSCH), used to dish out packet data to number of UEs; and additional DPDCHs to increase DL data throughput for a single UE.

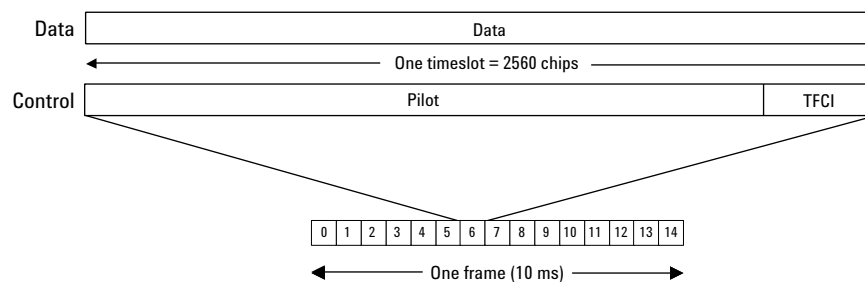
Uplink Physical Channels

The PRACH carries the RACH transport channel, which is used by the UE to request connection to the network as well as for intermittent services such as low duty cycle packet data. PRACH transmissions begin with a short preamble pattern that alerts the BTS of the forthcoming PRACH access message. The preamble consists of a complex signature and a scrambling code. The signature is a series of 16 bits that is repeated 256 times within a single preamble [9]. All BTS use the same 16 signatures. The BTS tells each UE which signature to use and then uses the signature to determine which UE it is communicating with. The scrambling code is used by the BTS to determine that the PRACH transmission is intended for that BTS. It can also allow the BTS to determine the access class of the UE. Access class is a means of establishing priority of access for different UE or different service types. In general, the preamble transmission can be initiated at any random instant and is therefore subject to collisions with other users. In this case, the UE will retransmit the preamble using different time access slots until acknowledgment is received.

The message part is transmitted as part of the PRACH after the UE receives acknowledgment from the BTS on the DL AICH. It consists of two parts: a control part and a data part. These two parts are transmitted in parallel. Figure 4-8 shows the message part structure. The control part carries the pilot and TFCI bits. The data part consists only of data bits that contain the information the UE wants to send to the network. The message part uses the same scrambling code used in the preamble.

Figure 4-8

Structure of the Message Part in the PRACH

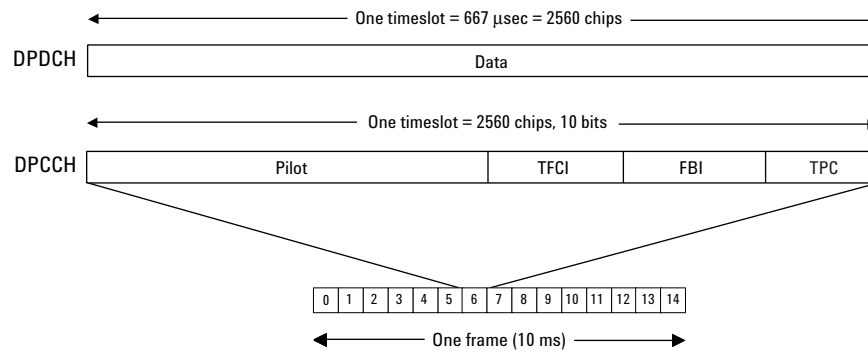


The PCPCH carries the CPCH transport channel and it is used for UL packet data transmission. The CPCH is an efficient way to send UL packet data since it requires fewer system resources as compared with a dedicated data channel. It is a random access channel and uses access procedures similar to the RACH. Since a packet transmission may span several frames, it is necessary for the BTS to control the PCPCH transmit power. After the CPCH access attempt is successfully acknowledged, the UE begins transmitting and the BTS responds with power control bits. Once the transmit power is stabilized, the UE will commence transmission of a multi-frame packet.

The UL DPDCH/DPCCH carries the user's digitized voice and data channels along with layer 3 signaling data. The payload data and signaling data (DPDCH) are transmitted on the "I" path of the QPSK modulator; the power control, pilot, and other overhead bits (DPCCH) are transmitted on the "Q" path. Figure 4-9 shows the slot structure of an UL DPDCH and a DPCCH. Multiple DPDCHs may be transmitted. In this case they are consecutively assigned to either the I or Q paths. Each channel is spread by an OVSF code and its amplitude can be individually adjusted. Before modulation, the composite spread signal is scrambled with a special function that minimizes the signal transitions across the origin of the IQ plane and the 0° phase shift transitions. This improves the peak-to-average power ratio of the signal [8].

Figure 4-9

Uplink Slot Structure of a DPDCH and a DPCCH



Concepts

Transport Format Detection

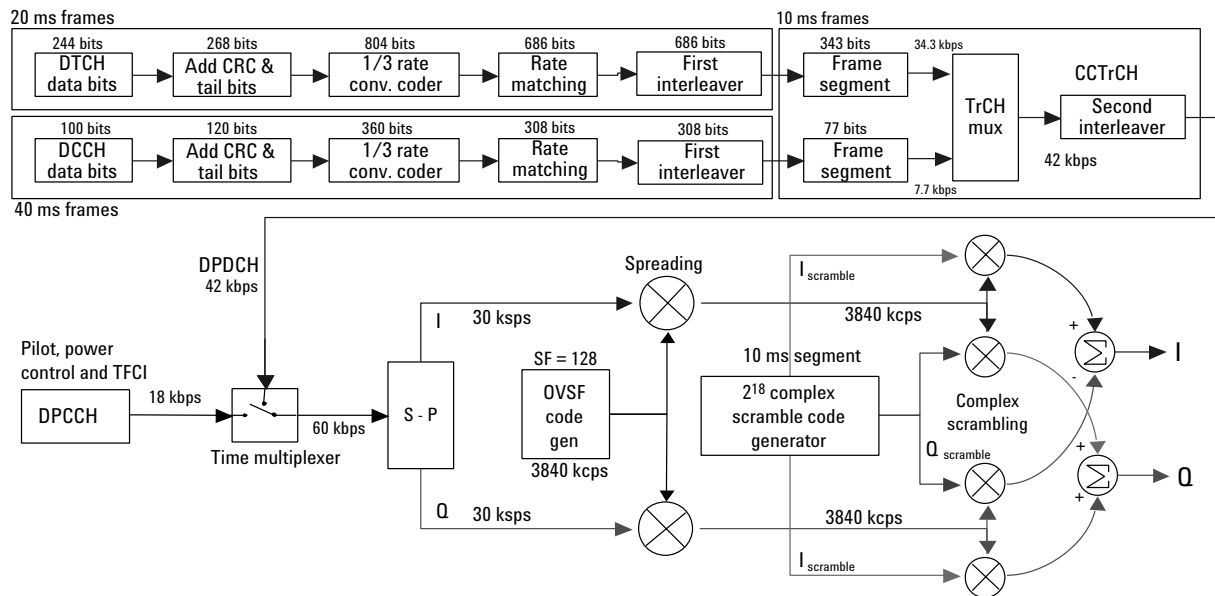
The number of possible arrangements of the W-CDMA air interface numbers in the millions. For any given connection only a small subset of these are needed. To make operation practical, that subset, known as the Transport Format Combination Set (TFCS), is communicated from the network to the UE at the time of connection setup. The TFCS includes all of the allowable Transport Formats (TF) and the associated data capacity for each of the channels that can be present in the link, and all of the allowable Transport Format Combinations (TFC) for the link. The Network's Radio Resource Control (RRC) entity provides this information to its lower layers. The UE's RRC entity does the same for its lower layers upon receiving the TFCS from the network. Once this information is shared between the two, the transmitter can use it, along with the demands for transmission capacity from higher layers, to decide which channels shall be present and how each channel will be arranged in the radio frame. Likewise the receiver can use it to determine which channels are present and how to recover each channel that is present.

The W-CDMA system provides two methods to make this determination. The first of these is the inclusion of a Transport Format Combination Indicator (TFCI) in each radio frame. The second is Blind Transport Format Detection (BTFD). When TFCI is used, the transmitting side determines which Transport Format Combination it will use. It then includes the TFCI, which is an index to the list of allowable combinations in the TFCS, in the control portion of the DPCH. The receiver always knows how to recover the TFCI, which it then uses to determine which channels to try to recover and how to decode each one. When BTFD is used, the receiver must try every allowable TFC in the TFCS to determine which one results in the least errors.

Downlink DPDCH/DPCCH Coding and Air Interface

Figure 4-10 shows an example of the coding, spreading, and scrambling for the DPCH. In this example, a 12.2 kbps voice service is carried on a DTCH logical channel that uses 20 ms frames. After channel coding, the DTCH is coded with a 1/3 rate convolutional encoder. In this example, the data is then punctured (rate matching) and interleaved. At this point, the DTCH is segmented into 10-ms frames to match the physical channel frame rate. The DCCH logical channel carries a 2.5 kbps data stream on a 40 ms frame structure. The DCCH is coded in the same manner as the DTCH. Frame segmentation for the DCCH involves splitting the data into four 10-ms segments to match the physical channel frame rate. The DTCH and DCCH are multiplexed together to form the Coded Composite Transport Channel (CCTrCH). The CCTrCH is interleaved and mapped onto a DPDCH running at 42 kbps.

Figure 4-10 Downlink DPDCH/DPCCH Coding, Spreading, and Scrambling



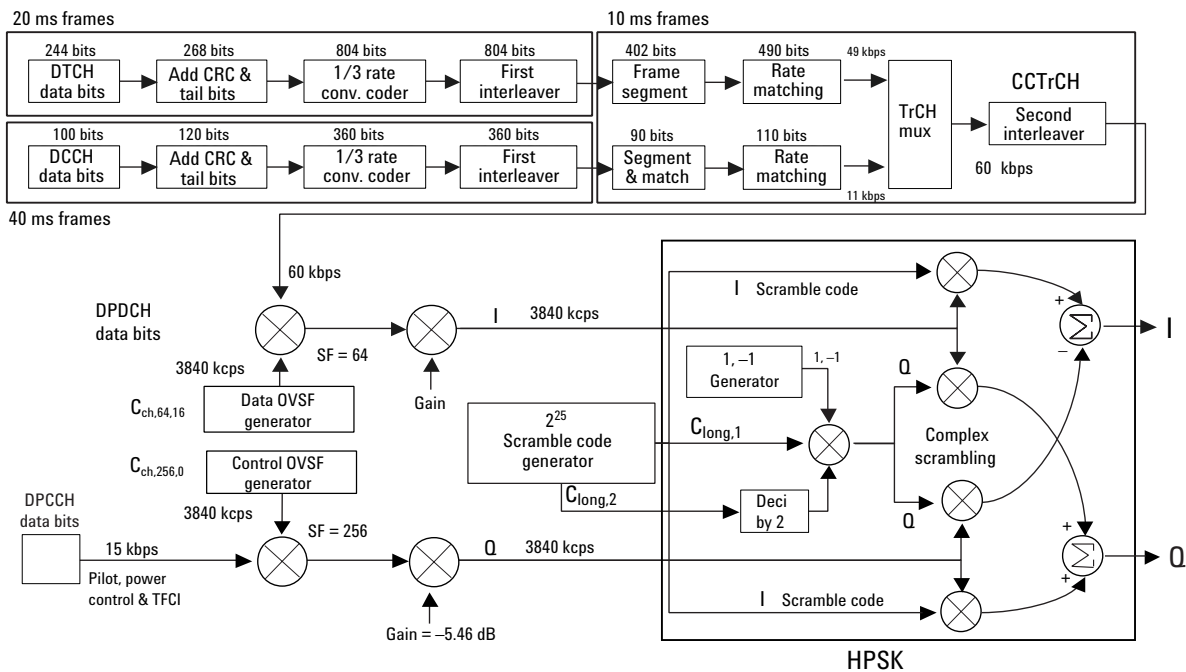
Concepts

In [Figure 4-10](#), the DPCCH is running at a rate of 18 kbps. The DPDCH and DPCCH are time multiplexed together (DPCH) to form a 60 kbps stream. This stream is converted into separate I and Q channels with a symbol rate of 30 ksps for each channel. The DPCH is spread with an OVSF code with spread factor equal to 128 (to reach the desired 3.84 Mcps), which differentiates the signal from others within the cell or sector. After that process, it is complex scrambled with a code that identifies each cell or sector. The resulting I and Q signals are then filtered with a root-raised cosine (RRC) filter of $\alpha = 0.22$ and used to modulate the RF carrier (not shown in the figure).

Uplink DPDCH/DPCCH Coding and Air Interface

The spreading and scrambling used on the UL DPDCH/DPCCH differ from the DL in two key areas: I/Q multiplexing and hybrid phase shift keying (HPSK) scrambling (instead of complex scrambling). Figure 4-11 shows an example of the coding and air interface for an UL DPDCH and DPCCH. In Figure 4-11, the logical DTCH carries a 12.2 kbps voice channel and the logical DCCH carries a 2.5 kbps signaling channel. Each of these logical channels is channel coded, convolutionally coded, and interleaved. The DTCH uses 20-ms frames. At the frame segmentation point, the DTCH is split into two parts to conform with the physical layer's 10-ms frame structure. The DCCH, which operates with 40-ms frames, is split into four parts so that each signaling frame is spread over four 10-ms radio frames. These channels are then punctured (rate matching) and multiplexed prior to spreading. The multiplexed data at this point is called the Coded Composite Transport Channel (CCTrCH). After a second interleaving, the CCTrCH is mapped onto a DPDCH running at 60 kbps. The DPDCH is spread with an OVSF code with spread factor equal to 64 in order to reach the desired 3.84 Mcps. After gain scaling (to adjust the transmission power for the variable spreading factor), the spread DPDCH is applied to the I channel. The DPCCH, which carries pilot, power control, and TFCI, is spread with an OVSF code with spread factor equal to 256 in order to reach the desired 3.84 Mcps. After gain scaling (to adjust the transmission power for the variable spreading factor), the spread DPCCH is applied to the Q channel. The I and Q channels are then combined using HPSK scrambling.

Figure 4-11 Uplink DPCH/DPCCH coding, spreading, and scrambling.



The data rate for the UL DPCCH is always 15 kbps. The DPCCH data is spread with an OVSF code with $SF = 256$ to reach the 3.84 Mcps rate and is gain scaled in this example to be -6 dB relative to the DPDCH. The DPCCH is then applied to the Q channel. If additional DPDCHs were present they would be assigned to I or Q and spread with the appropriate OVSF code. Before modulation, the composite spread signal is scrambled with a special complex function that limits the signal transitions across the origin of the IQ plane and the 0° phase shift transitions. This improves its peak-to-average power ratio. This function can be considered a variation of regular complex scrambling and is commonly known as HPSK, although this term is not mentioned in the 3GPP specifications. The scrambling generator produces two random sequences (referenced in the 3GPP specifications as $C_{long,1}$ and $C_{long,2}$, if long scrambling sequences are used. The second sequence is decimated, multiplied by the function $\{1,-1\}$ and by the first sequence, and applied to the Q path of the complex scrambler. The first sequence is applied to the I path of the complex scrambler. The resulting I and Q signals are then filtered with an RRC filter ($\alpha = 0.22$) and used to modulate the RF carrier (not shown in [Figure 4-11](#)).

Reference measurement channels

In order to avoid ambiguity and inconsistency across different equipment suppliers, the 3GPP specifications define the UL and DL channel configurations to use for UE transmitter and receiver conformance testing, respectively [12]. These configurations are called reference measurement channels. There are four DL reference measurement channels and five UL reference measurement channels. All of them consist of a DPDCH and a DPCCH. The main difference between the four DL or five UL reference measurement channels is the information bit rate for the DTCH logical channel (12.2 kbps, 64 kbps, 144 kbps, and 384 kbps). A 768 kbps information bit rate is also available for the UL only.

The data rates in the channel configuration example in [Figure 4-10](#) correspond to the 12.2 kbps DL reference measurement channel. The data rates in the channel configuration example in [Figure 4-11](#) correspond to the 12.2 kbps UL reference measurement channel. The 12.2 kbps UL (or DL) reference measurement channel is the test channel configuration specified for most UE transmitter (or receiver) conformance tests. Appendix A provides the complete structure and parameter description for the 12.2 kbps UL and DL reference measurement channels as they appear in the 3GPP specifications.

Compressed Mode

Compressed mode allows the BTS and UE to momentarily stop transmitting a particular DPCH. This enables the UE to make signal strength measurements on other frequencies, as would be needed to perform an inter-frequency or inter-system (hard) handover. One to seven slots per frame can be allocated for the UE to perform these measurements. These slots can be in the middle of a single frame or spread over two frames. The portions of the frame where the power is turned off are referred to as Discontinuous Transmission (DTX) in the specifications.

The 3GPP specifications define three different methods to achieve compressed mode:

- Reducing the SF by 2 (shorter OVVSF code). The data is transmitted at a higher rate to make room for DTX.
- Reducing the symbol rate by puncturing the output of the error correction encoder to reduce the number of bits per frame to a number that can be carried by the smaller number of symbols available in the compressed radio frame. This method is only used in the DL.
- Higher layer scheduling. The data rate from higher layers in the protocol is limited by restricting the TFCs that can be used and delaying the transmission of some data. This effectively reduces the number of timeslots for user traffic.

Asynchronous Cell site Acquisition

Other CDMA systems use GPS to precisely synchronize the time reference of every BTS. This provides the benefit of simplifying acquisition and inter-cell handover. In particular, the scrambling codes, short Pseudo-noise (PN) codes, used by IS-95 BTS are uniquely time-delayed versions of the same code. A time-delayed version of a PN code behaves as if it were a statistically independent code, so each BTS can therefore be distinguished based on a simple time offset measurement rather than a complicated search through multiple codes. Furthermore, soft handover is simplified since the frame timing of every BTS is closely synchronized. This technique, while simplifying UE operation, requires GPS synchronization and code offset planning at the cell sites in order to insure that no PN code can be confused with another after undergoing propagation delay.

One of the W-CDMA design goals was to remove the requirement for GPS synchronization. Without dependence on GPS, the system could potentially be deployed in locations where GPS is not readily available, such as in a basement of a building or in temporary locations. W-CDMA accomplishes this asynchronous cell site operation through the use of several techniques.

First, the scrambling codes in W-CDMA are Gold codes rather than PN codes. In W-CDMA, the Gold codes are unique codes rather than time offsets of the same code. Therefore, precise cell site time synchronization is not required. There are, however, 512 unique Gold codes allocated for cell site separation. The UE must now search through a number of scrambling codes, rather than simply searching through various time offsets of the same code. In order to facilitate this task, the SSC in the S-SCH channel is used to instruct the UE to search through a given set of 64 Gold codes. Each set represents a group of eight scrambling codes ($64 \times 8 = 512$). The UE then tries each of the eight codes within each code group, in an attempt to decode the BCH. The ability to recover the BCH information (system frame number) completes the synchronization process.

Asynchronous Cell Site Soft Handover

In CDMA soft handover, a UE can establish simultaneous communication with several BS. During soft handover the combined signals from each BTS are individually correlated and then combined. As such, communication is possible in situations where an individual signal from a single BTS might otherwise be too weak to support the radio link.

With each W-CDMA BTS operating on an asynchronous clock, soft handover is complicated by the fact that frame timing between BTS is not explicitly coordinated. The UE could therefore have a difficult time combining frames from different BTS. To get around this problem, the W-CDMA UE measures the frame timing differential between the originating BTS and the handover target BTS. The UE reports this frame timing back to the network, which then issues a frame timing adjustment command to the target BTS. The target BTS adjusts the frame timing of the DPDCH/DPCCH channel that is being transmitted so the UE receives the target BTS frames in close time alignment with the corresponding frames from the originating BTS. With this time alignment feature, the UE's rake receiver is able to track the received signals from both BTS.

HSDPA Concepts

What is HSDPA?

High Speed Downlink Packet Access (HSDPA) is a digital packet communications format that supports high speed data transmission within the existing W-CDMA communications system. Appropriate uses for HSDPA are DL data bit streams like those employed for Internet browsing, video, or GPS mapping data. HSDPA physical layer code channels are defined in 3GPP TS 25.21 1-214 v.5xx.

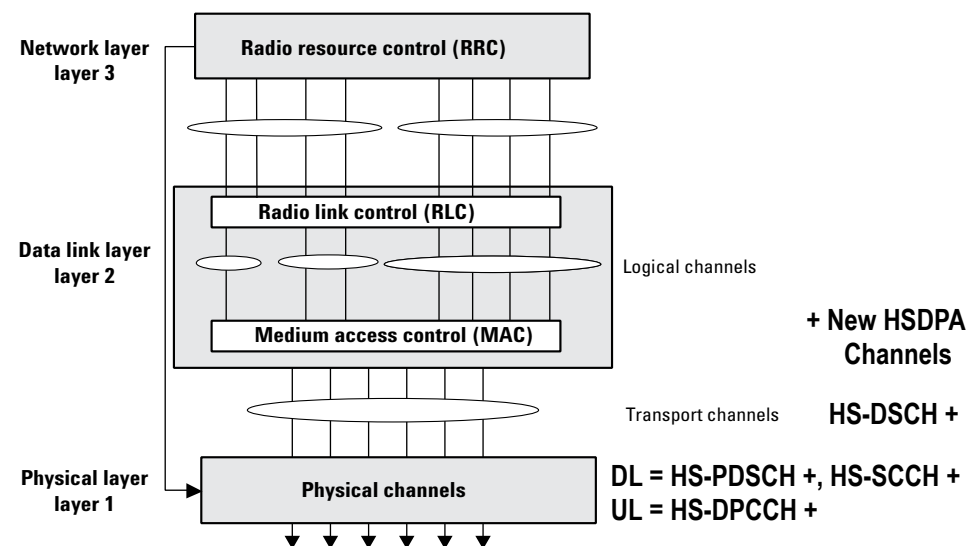
HSDPA is a packet-based data service that operates inside a W-CDMA downlink with data transmission up to 8-10 Mbps (and 20 Mbps for MIMO systems) over a 5MHz bandwidth in WCDMA downlink. HSDPA implementations as defined by 3GPP include Adaptive Modulation and Coding (AMC), Multiple-Input Multiple-Output (MIMO), Hybrid Automatic reQuest (HARQ), and fast cell search.

Protocol Structure

The protocol structure of the HSDPA system is the same as the W-CDMA protocol structure. HSDPA employs existing W-CDMA logical channels, but uses different transport and physical layer channels. [Figure 4-12](#) shows the three bottom W-CDMA layers, and the corresponding HSDPA channels.

Figure 4-12

W-CDMA Protocol Structure w/ HSDPA Channel Overlay



For more information about the W-CDMA Protocol Structure see [“Protocol Structure” on page 403](#).

HSDPA Logical, Transport, and Physical Channels

HSDPA cooperates with existing W-CDMA transport channels to support sharing physical resources between multiple services. Each service, such as data, fax, voice, or signaling, is routed into different transport channels by the upper signaling layers. These services may have different data rates and error control mechanisms. The transport channels are then multiplexed as required prior to transmission via one or more physical channels. High data rate services or a combination of lower rate transport channels may be multiplexed into several physical channels. This flexibility allows numerous transport channels (services) of varying data rates to be efficiently allocated to physical channels. By multiplexing these transport channels efficiently, system capacity is optimized. For example, if the aggregate data rate of three transport channels exceeds the maximum of a single physical channel, then the data can be routed to two lower rate physical channels that closely match the total required data rate. Transport channels include the Broadcast Channel (BCH), the Paging Channel (PCH), the Forward Access Channel (FACH), the Dedicated Channel (DCH), the HSDPA High-Speed Downlink Shared Channel (HS-DSCH, which corresponds to the HS-PDSCH) and the Random Access Channel (RACH). [7]

HSDPA also cooperates with W-CDMA DL physical channels. The most important DL physical channels are the Common Pilot Channel (CPICH), the Primary Common Control Physical Channel (P-CCPCH), the Secondary Common Control Physical Channel (S-CCPCH), the Dedicated Physical Data and Control Channels (DPDCH/DPCCH), the HSDPA High-Speed Physical Downlink Shared Channel (HS-PDSCH), and the HSDPA Shared Control Channel (HS-SCCH). The UL consists of a Physical Random Access Channel (PRACH), a Physical Common Packet Channel (PCPCH), Dedicated Physical Data and Control Channels (DPDCH/DPCCH), and the HSDPA Dedicated UL Physical Control Channel (HS-DPCCH). The W-CDMA channels above are described in the following sections. For more information on W-CDMA channels see “[Logical Transport and Physical Channels](#)” on page 404.

Figure 4-13

HSDPA Logical, Transport, and Physical Channel Mapping

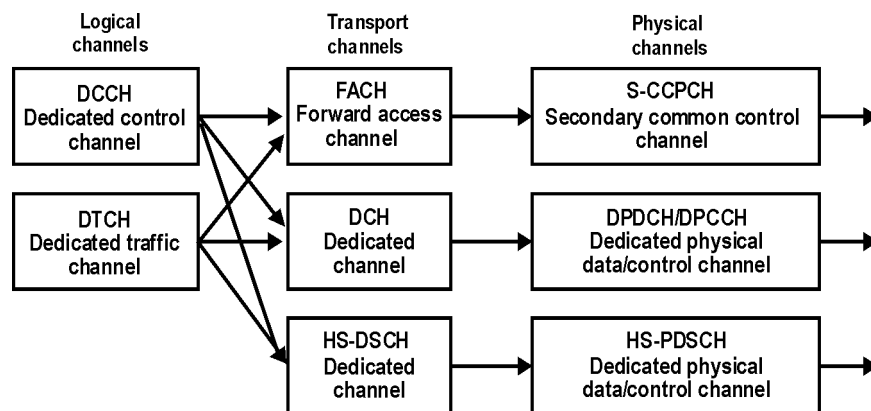


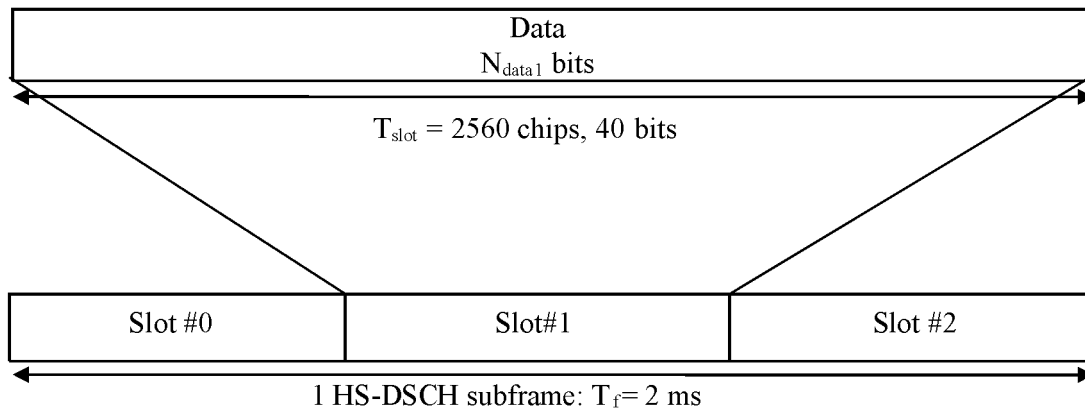
Figure 4-13 on page 420 shows an example of channel mapping for the DL. When a UE is in idle mode (not in High-Speed mode), the BTS sends dedicated signaling information from the DCCH logical channel through the FACH transport channel. This maps the information onto the S-CCPCH physical channel for transmission to a UE. When the UE is in the High-Speed connection mode, the same signaling information is routed through the HS-DSCH transport channel. This maps the information onto the HS-SCCH physical channel for transmission to the UE.

Downlink Physical Channels

High-Speed Shared Control Channel (HS-SCCH)

The HS-SCCH is a fixed rate (60 kbps, SF=128) downlink physical channel used to carry downlink signalling related to HS-DSCH transmission. Figure 4-14 illustrates the sub-frame structure of the HS-SCCH.

Figure 4-14 Subframe Structure of HS-SCCH



Slot #0 carries modulation information of HS-PDSCH, such as Channelization Code Set and Modulation Scheme.

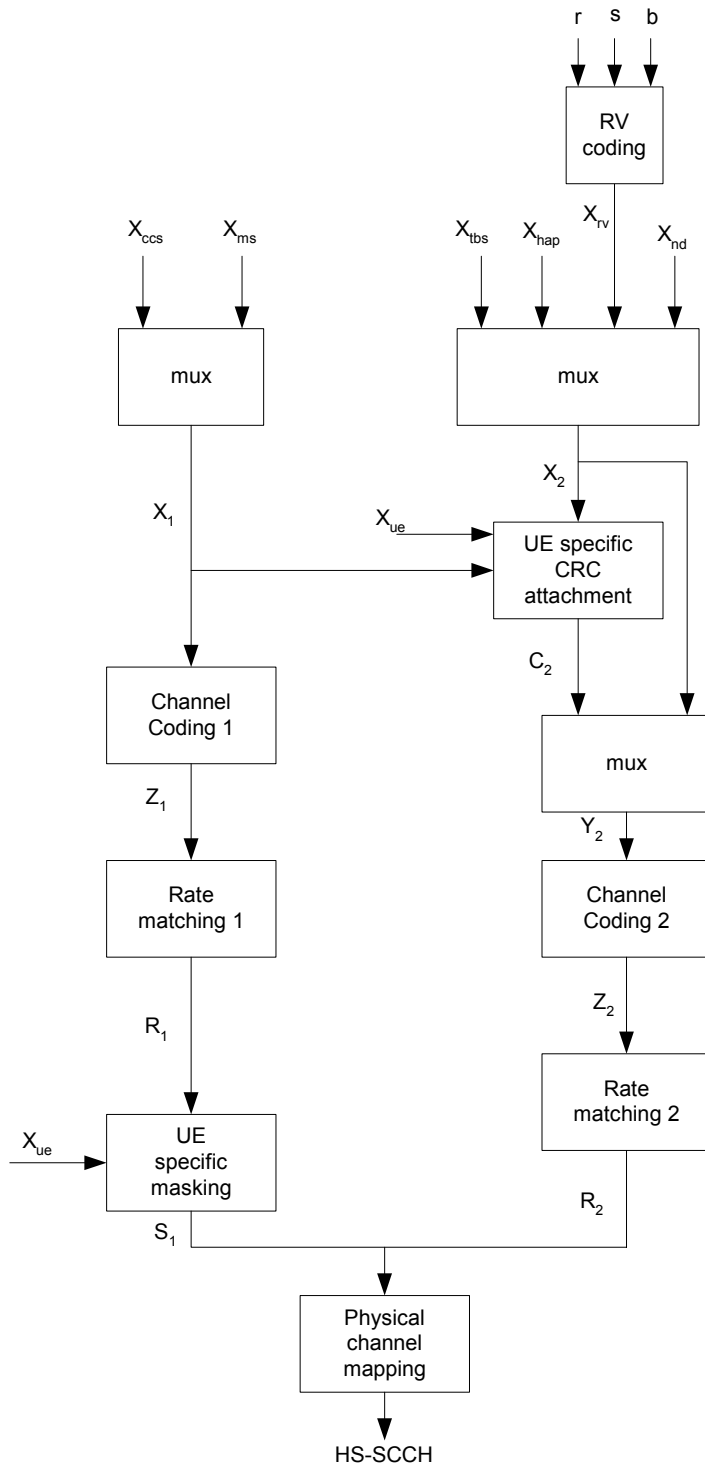
Slots #1 and #2 carry channel-coding information of HS-DSCH shown below. Data contained in Slot #0,#1,#2 is “covered” with UE identity.

The following information is transmitted by means of the HS-SCCH physical channel:

- Channelization-code-set information (7 bits)
- Modulation scheme information (1 bit)
- Transport-block size information (6 bits)
- Hybrid-ARQ process information (3 bits)
- Redundancy and constellation version (3 bits)
- New data indicator (1 bit)
- UE identity (16 bits)

[Figure 4-15 on page 423](#) shows the HS-SCCH channel coding.

Figure 4-15 HS-SCCH Channel Coding



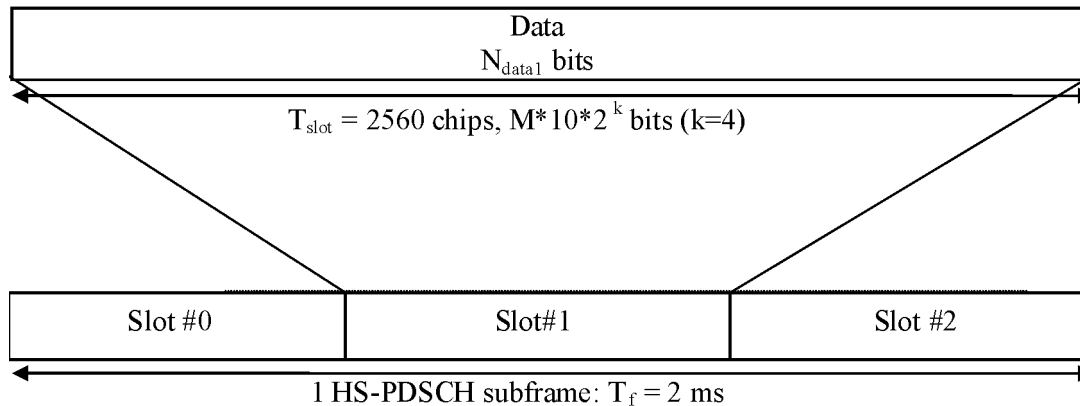
Concepts

High-Speed Physical Downlink Shared Channel (HS-PDSCH)

The High Speed Physical Downlink Shared Channel (HS-PDSCH) is used to carry the High Speed Downlink Shared Channel (HS-DSCH).

An HS-PDSCH corresponds to one channelization code of fixed spreading factor SF=16 from the set of channelization codes reserved for HS-DSCH transmission. Multi-code transmission is allowed, which translates to UE being assigned multiple channelization codes in the same HS-PDSCH subframe, depending on its UE capability. Table 4-1 shows the HS-DSCH data fields.

Figure 4-16 Subframe Structure for HS-PDSCH



An HS-PDSCH may use QPSK or 16QAM modulation symbols. In Figure 4-16 above, M is the number of bits per modulation symbols i.e. M=2 for QPSK and M=4 for 16QAM

The subframe and slot structure of HS-PDSCH is shown in Figure 4-16. An HS-PDSCH may use QPSK or 16QAM modulation symbols. In Figure 4-16, M is the number of bits per modulation symbols i.e. M=2 for QPSK and M=4 for 16QAM. The slot formats are shown in Table 4-1 on page 424.

Table 4-1 HS-DSCH Fields

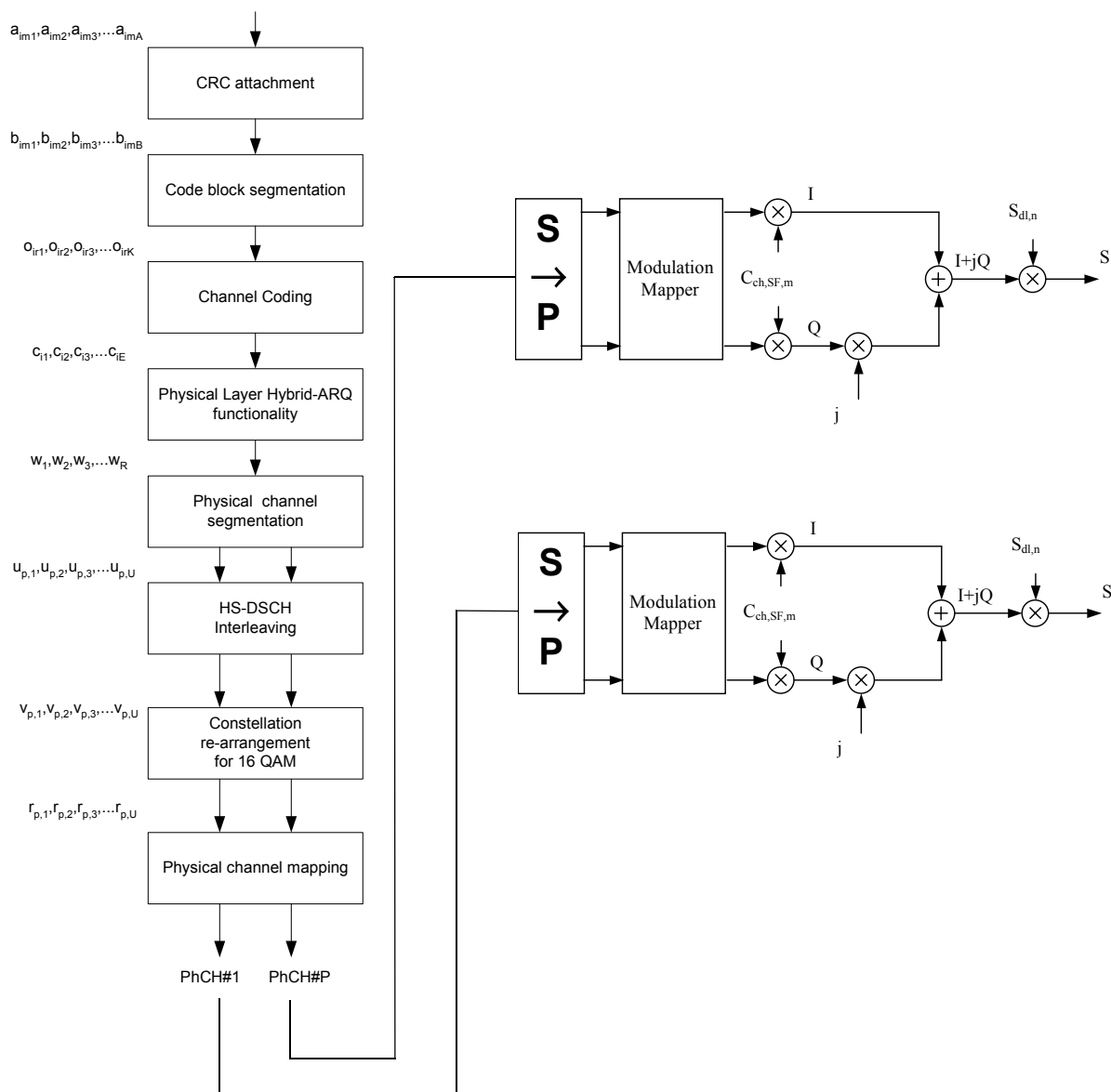
Slot Format #i	Channel Bit Rate (kbps)	Channel Symbol rate	SF	Bits per HS-DSCH Subframe	Bits/Slot	Ndata
0 (QPSK)	480	240	16	960	320	320
1 (16QAM)	960	240	16	1920	640	640

Downlink HS-PDSCH Coding and Air Interface

Figure 4-17 depicts how the downlink HS-DSCH transport channel is coded into physical HS-PDSCH channel(s). The output of “Physical channel segmentation” can be multiple code channels, in this example, there are 2. In this manner one HS-DSCH transport channel can be mapped to two or more physical HS-PDSCH channels in order to support higher data rates.

For more information about Downlink coding see the corresponding W-CDMA section “Downlink DPDCH/DPCCH Coding and Air Interface” on page 411.

Figure 4-17 Downlink HS-PDSCH Coding, Spreading, and Scrambling



HSDPA Test Model 5

The Agilent PSA Series and E4406A VSA Options BAF and 210 provide complete HSDPA measurements to make the same suite of tests as for W-CDMA, but a new Test Model has been added to allow HSDPA signals to be analyzed. 3GPP specifications require that Test Model 5 be used for qualification of base station equipment, so it is provided in the **Meas Setup, Symbol Boundary** menus for Modulation Accuracy (Composite EVM) and Code Domain Power measurements, along with the four previous W-CDMA test models.

3GPP Test Model 5 specifications include two new code channels; the High-Speed Physical Downlink Shared Channel (HS-PDSCH) and the High-Speed Shared Control Channel for HS-DSCH (HS-SCCH).

Table 4-2

HSDPA Test Model 5 Code Channels

Code Channel	Symbol Encoding	OVSF Spread Factor
HS-PDSCH	16QAM	16 (640 symbols/slot)
HS-SCCH	QPSK	128

These code channels are described in detail in the following section, [“Downlink Physical Channels” on page 406](#).

Uplink Physical Channel

High-Speed Dedicated Physical Control Channel (HS-DPCCH)

The HS-DPCCH carries uplink feedback signalling related to downlink HS-DSCH transmission. The HS-DSCH-related feedback signalling consists of Hybrid-ARQ Acknowledgement (HARQ-ACK) and Channel-Quality Indication (CQI). Each sub frame of length 2 ms (3×2560 chips) consists of 3 slots, each of length 2560 chips. The HARQ-ACK is carried in the first slot of the HS-DPCCH sub-frame. The CQI is carried in the second and third slot of an HS-DPCCH sub-frame. There is at most one HS-DPCCH on each radio link. The HS-DPCCH can only exist together with an uplink DPCCH.

Figure 4-18 Subframe Structure for HS-DPCCH

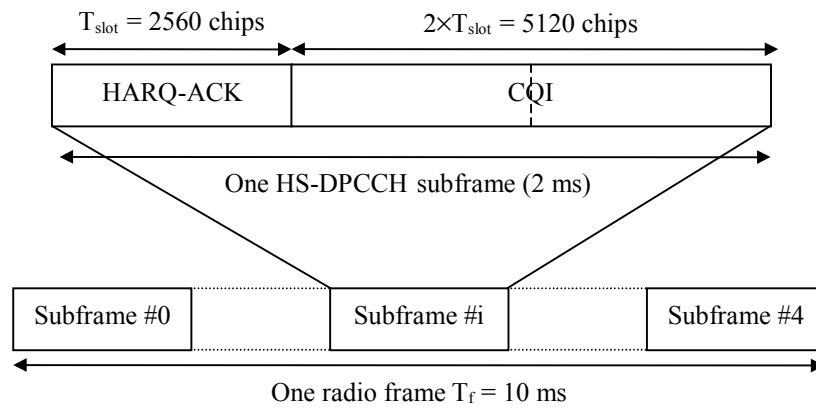


Table 4-3 HS-DPCCH Fields

Slot Format #i	Channel Bit Rate (kps)	Channel Symbol Rate (kps)	SF	Bits per Subframe	Bits per Slot	Xmitted Slots per Frame
0	15	15	256	30	10	3

Uplink HS-DPCCH Coding and Air Interface

The input summation block, spreading, and scrambling used on the UL HS-DPCCH is shown in Figure 4-19. The diagram shows an example of the coding and air interface for an UL HS-DPCCH and multiple DPDCH channels. In the case of only one DPDCH, the W-CDMA coding shown Figure 4-11 is employed. The summing scheme shown below is also used for non-HS coding when more than one DPDCH is employed.

The channelization scheme used for the summation block is shown in Table 4-4 on page 429.

Figure 4-19 Uplink DPDCH/HS-DPCCH coding, spreading, and scrambling.

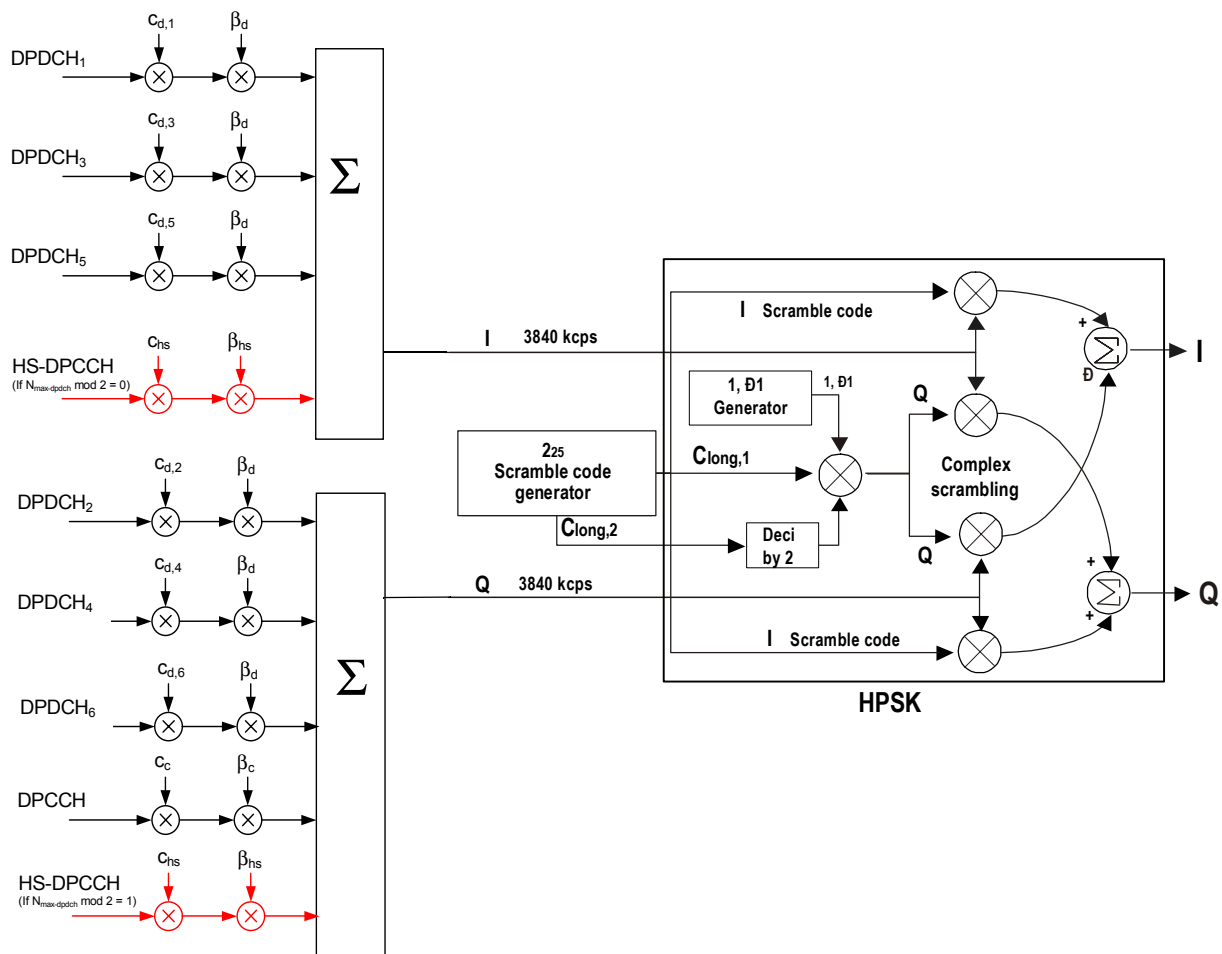


Table 4-4 Channelization Code of HS-DPCCH

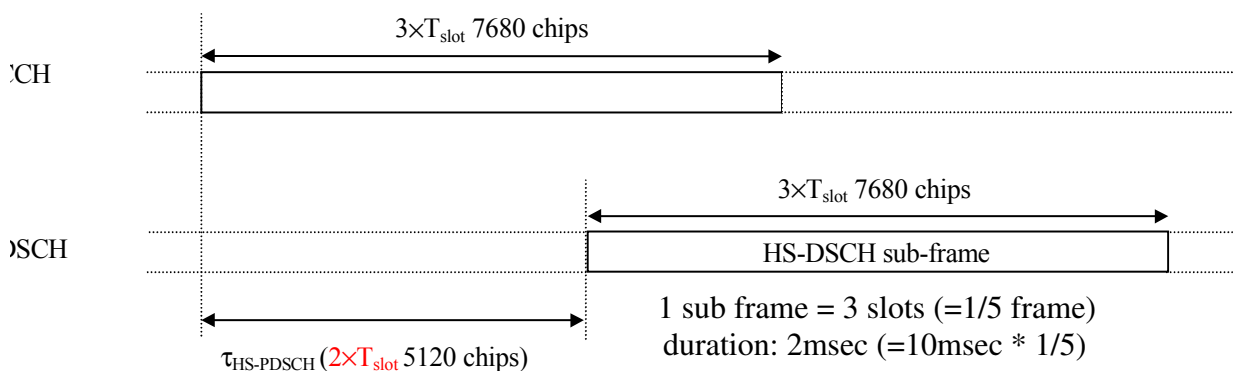
$N_{\text{max-dpdch}}$	Channelization Code C_{ch}
0	$C_{\text{ch},256,33}$
2,4,6	$C_{\text{ch},256,1}$
3,5	$C_{\text{ch},256,32}$

In order to balance total power on I and Q axes, HS-DPCCH's channelization code varies depending on DPDCH channel's activity status. There are two possible HS-DPCCH positions on the summation block. If the number of DPDCH is even, HS-DPCCH is included in I-summation. If the number of DPDCH is odd, HS-DPCCH is included in Q-summation. Table 4-4 shows that HS-DPCCH's code number varies by the number of DPDCH. For example, if there are three DPDCH channels, the HS-DPCCH code number is 32, and since "three" is an odd number of DPDCH channels, the HS-DPCCH is included in Q-axis summation.

HSDPA Physical Channel Timing

Figure 4-20 shows the relationship between the HS-SCCH and the HS-PDSCH physical channels in the DL.

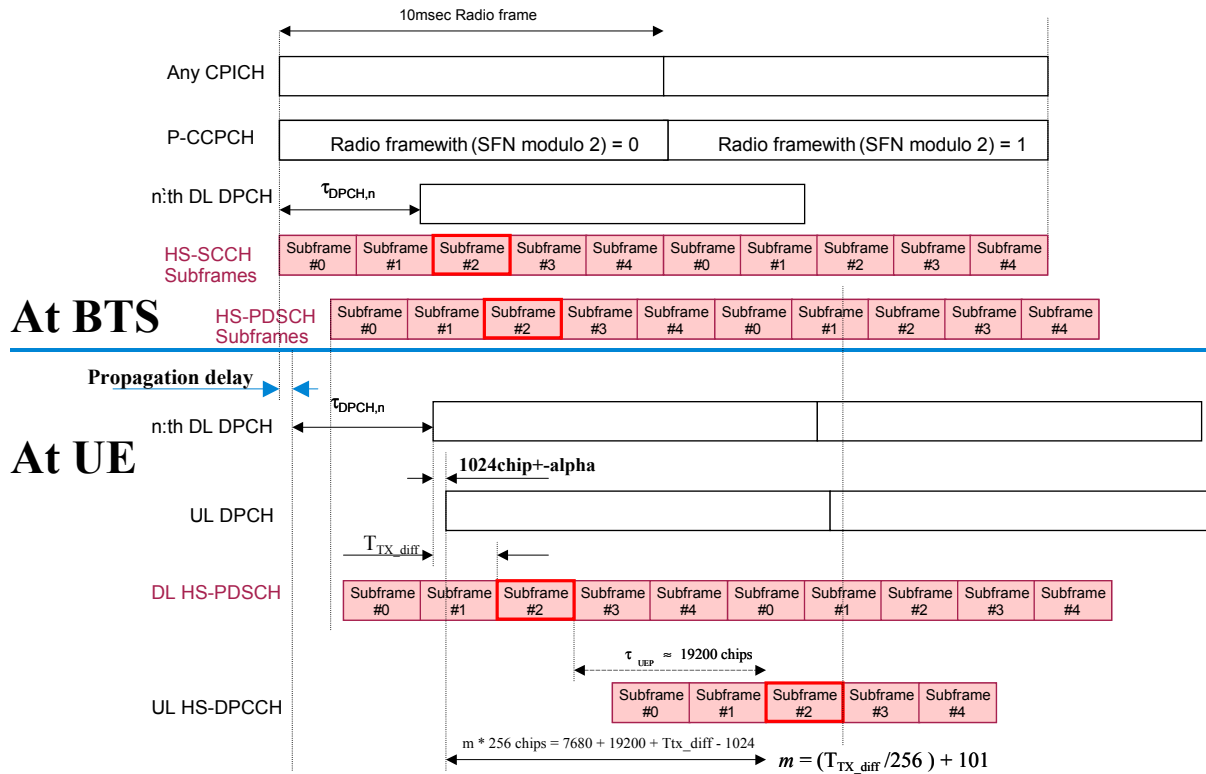
Figure 4-20 HS-SCCH/HS-PDSCH Timing (Downlink)



The HS-PDSCH starts $\tau_{\text{HS-PDSCH}} = 2 \times T_{\text{slot}} = 5120$ chips after the start of the HS-SCCH.

Figure 4-21 shows a diagram of the radio frame timing relationships between the UL and DL physical channels.

Figure 4-21 Radio Frame Timing of UL and DL Physical Channels



Transport Format Detection

HSDPA uses the W-CDMA Transport Format Combination Set (TFCS), to communicate from the network to the UE at the time of connection setup. The TFCS includes all of the allowable Transport Formats (TF) and the associated data capacity for each of the channels that can be present in the link, and all of the allowable Transport Format Combinations (TFC) for the link. The Network's Radio Resource Control (RRC) entity provides this information to its lower layers. The UE's RRC entity does the same for its lower layers upon receiving the TFCS from the network. Once this information is shared between the two, the transmitter can use it, along with the demands for transmission capacity from higher layers, to decide which channels shall be present and how each channel will be arranged in the radio frame. Likewise the receiver can use it to determine which channels are present and how to recover each channel that is present.

HSDPA also uses the same two W-CDMA methods to make this determination. The first of these is the inclusion of a Transport Format Combination Indicator (TFCI) in each radio frame. The second is Blind Transport Format Detection (BTFD). When TFCI is used, the transmitting side determines which Transport Format Combination it will use. It then includes the TFCI, which is an index to the list of allowable combinations in the TFCS, in the control portion of the DPCH. The receiver always knows how to recover the TFCI, which it then uses to determine which channels to try to recover and how to decode each one. When BTFD is used, the receiver must try every allowable TFC in the TFCS to determine which one results in the least errors.

Modulation Scheme Detection

The DL HS-PDSCH may be modulated using either QPSK or 16QAM. MS (UE) gets the modulation scheme in advance of the actual modulated signal from information encoded into the HS-SCCH. The modulation scheme can change dynamically as often as every subframe, or every 3 slots.

The Agilent PSA Series and E4406A VSA Options BAF and 210 use BTFD to detect the modulation scheme. For Code Domain and Modulation Accuracy (Composite EVM) measurements the user can select the method by which the modulation scheme is detected, or the modulation scheme can be predetermined. For details see [“Code Domain Measurement Concepts” on page 459](#), or [“Modulation Accuracy - \(Composite EVM\)” on page 476](#).

HSDPA Measurement Concepts

High speed downlink packet access (HSDPA) is a new packet-based service in the Third Generation Partnership Project (3GPP) Wideband-Code Division Multiple Access (W-CDMA) radio format. Designed to provide higher data throughput on the downlink, it was first introduced in Release 5 of the 3GPP specifications. HSDPA employs adaptive modulation and coding to continually reconfigure the downlink, optimizing data throughput for each user depending on the instantaneous quality of the link. The new service is backwards compatible with 3GPP Release 99 and can be used in conjunction with other services to the same user equipment (UE). Voice and data applications developed for W-CDMA Release 99 can still be run on the upgraded Release 5 networks, and the same radio channel will support W-CDMA and HSDPA services simultaneously.

The changes that HSDPA introduces have test implications in many different areas, including the radio frequency (RF). New UE transmitter and receiver characteristic requirements and a whole new section for UE HSDPA performance requirements have been added to the Release 5 and Release 6 RF conformance test specifications.

Why Test HSPDPA User Equipment?

Although HSDPA is primarily a baseband or signaling extension to W-CDMA, many aspects of the new service require specialized testing.

The main aspects of HSDPA technology that have implications for physical layer testing of the UE are the following:

- The new uplink high speed dedicated physical control channel (HS-DPCCH) increases the peak-to-average power ratio (PAR).
- The uplink HS-DPCCH is not usually transmitted continuously and can be offset in time from the dedicated physical control channel (DPCCH).
- The new 16QAM format in the downlink high speed physical data shared channel (HS-PDSCH) has less margin for UE receiver impairments than does QPSK.
- Decoding the downlink high speed data shared channel (HS-DSCH) involves complex new functionality.
- Accurate channel quality reporting is crucial to overall system performance.
- Without correct detection of the high speed shared control channel (HS-SCCH) downlink control information, HSDPA communication is not possible.

Each of these areas of change and the implications for testing are next discussed briefly.

HS-DPCCH increases uplink peak-to-average power ratio (PAR)

The biggest change on the uplink is the addition of the high speed dedicated physical control channel (HS-DPCCH).

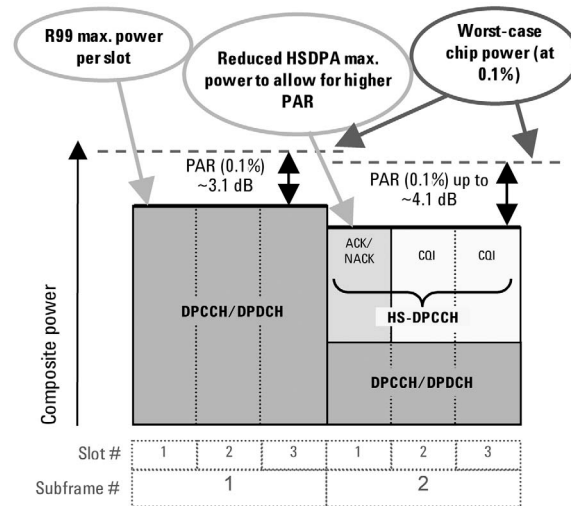
The standard Release 99 W-CDMA uplink signal, which consists of the dedicated physical data channel (DPDCH) and the DPCCH, can have a peak-to-average power ratio (PAR) at 0.1% from about 3.1 dB to about 3.6 dB, depending on the signal configuration. The new code channel (HS-DPCCH) can add up to ~1 dB to the PAR (at 0.1%) of the uplink signal.

Because the HS-DPCCH is not usually transmitted continuously, the PAR increases only when the acknowledgement/negative acknowledgement (ACK/NACK) or the channel quality indicator (CQI) fields are transmitted. The exact increase in the PAR depends on the beta factors β_c , β_d , and β_{hs} , which correspond to the relative power levels of the uplink DPCCH, DPDCH, and HS-DPCCH.

A higher PAR can increase the distortion generated by the transmitter, and particularly by the power amplifier, resulting in higher out-of-channel interference and poorer modulation quality. So that Release 99 power amplifiers will work correctly with this higher PAR signal, the maximum output power requirement is reduced when the HS-DPCCH is on.

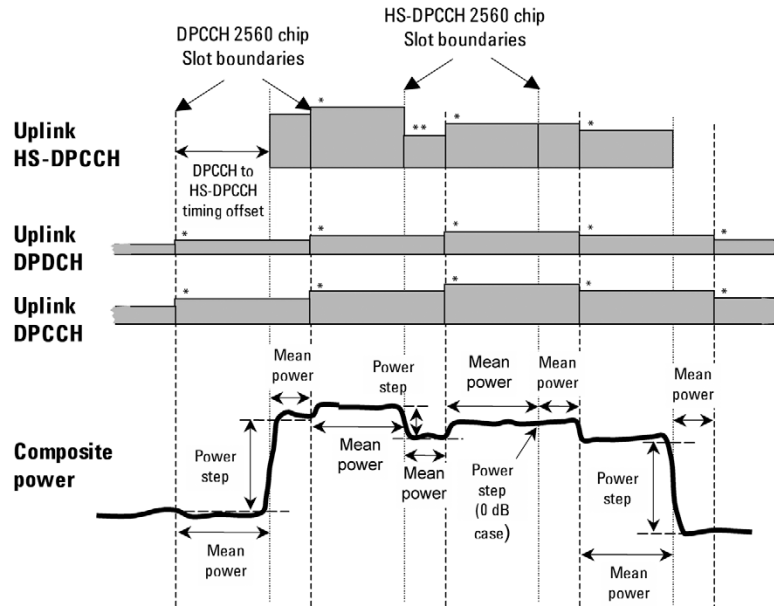
The following figure illustrates how PAR increases when the ACK/NACK or the CQI fields in the HS-DPCCH are transmitted, and how the maximum composite average output power is reduced to compensate for this increase.

Figure 4-22 HS-DPCCH Increases Uplink Peak-to-Average Power Ratio (PAR)



The HS-DPCCH is not usually transmitted continuously and can be offset in time from the DPCCH. Turning the HS-DPCCH on and off can cause power steps of up to 7 dB, depending on the beta factors. The HS-DPCCH is a shared channel and therefore is fixed in time relative to the common pilot channel (CPICH). The DPDCH and DPCCH, however, can be shifted in time in 0.1 slot increments. In the generic example of power versus time shown below, observe that the HS-DPCCH is not aligned in time with these other channels. Additionally, the CQI relative power (CQI) differs from the ACK/NACK relative power (ACK or NACK). So that the accuracy of the power steps can be verified in such cases, a new test of the power-versus-time mask has been added to the specifications.

Figure 4-23 Transmit Power Template During HS-DPCCH Transmission



* = step due to inner loop power control
** = step due to CQI transmission

If the HS-DPCCH is not time-aligned with the DPCCH/DPDCH, the 7 dB power step may occur during transmission of the DPCCH/DPDCH slot. Such an occurrence introduces the potential for phase transients or other distortions during the slot transmission, which then degrade the signal quality and impact the ability of the Node B (base station) to demodulate the DPCCH/DPDCH when the HS-DPCCH is transmitted. New modulation accuracy requirements being developed by the 3GPP could address this issue.

Before the UE can decode HSDPA downlink traffic data in the HS-DSCH, it must first recognize the control information sent by the BTS and carried by the downlink high speed shared control channel (HS-SCCH). In other words, if the UE cannot detect the HS-SCCH control information, it will not be able to decode the payload data on the HS-PDSCH and data throughput will cease. Verifying the performance of HS-SCCH detection is, therefore, an important test. For this reason, an HS-SCCH detection test has been added to the specifications.

HSDPA UE RF Conformance Tests

To address the challenges introduced by HSDPA, a number of HSDPA-related tests have been added to the UE RF conformance tests (3GPP TS 34.121) in Release 5 and Release 6. Note that there are five new transmitter tests required in 34.121 Section 5:

- Maximum Output Power With HS-DPCCH (34.121 5.2A)
- Transmit ON/OFF Power – HS-DPCCH (34.121 5.7A)
- SEM (34.121 5.9A)
- ACLR (34.121 5.10A)
- EVM (34.121 5.13.1A)

One new test of receiver characteristics is required in 34.121 Section 6:

- Maximum Input Level for HS-PDSCH Reception Using 16QAM (34.121 6.3A)

A whole new section, HSDPA Performance Requirements (34.121 Section 9), covers three main test areas:

- Demodulation of HS-DSCH (34.121 9.2)
- Reporting of CQI (34.121 9.3)
- HS-SCCH Detection Performance (34.121 9.4)

The following table lists the most general downlink signal configuration for single-link (non-diversity) scenarios. For simplicity these parameters reflect the minimum requirements from 3GPP TS 25.101 in the specifications, not the relaxed test requirements from 3GPP TS 34.121 that take into account test system uncertainty. Refer to 3GPP TS 34.121 annex E.5.1 and E.6.2 for more information on the general test configuration of the downlink physical channels.

Channel	Level vs. Ior	Notes
P-CPICH	-10 dB	S-CPICH is off (DTX)
P-CCPCH & SCH	-12 dB	Time multiplexed
PICH	-15 dB	
DPCH	Test specific	12.2 k RMC
HS-SCCH-1	Test specific	HS-SCCH-2, 3, 4 are off (DTX)
HS-DSCH (HS-PDSCHs)	Test specific	
OCNS	Remainder	6 channels: 34.121 table E.5.5

Note: The HS-SCCH and the HS-DSCH shall be transmitted continuously (in every TTI) with constant power, but only be allocated to the UE under test during the appropriate TTIs.

Fixed reference channels

Fixed reference channel H-Sets (FRC H-Sets) are the HSDPA equivalent of the reference measurement channels (RMC) used for W-CDMA. The FRC H-Sets define the HS-DSCH configurations most often used for HSDPA conformance testing.

The term “fixed” refers to the static nature of the modulation and coding of these channels. As indicated earlier, AMC is not used because of the difficulty in isolating the performance of the SS from that of the UE.

There are five FRC H-Sets (FRC H-Set 1 to 5) defined in Release 5. Another FRC H-Set (FRC H-Set 6) has been added in Release 6. For some of the tests, such as Demodulation

of HS-DSCH, the UE category determines which FRC H-Set to use:

- FRC H-Set 1 for UE of HS-DSCH category 1 and 2
- FRC H-Set 2 for UE of HS-DSCH category 3 and 4
- FRC H-Set 3 for UE of HS-DSCH category 5 and 6
- FRC H-Set 4 for UE of HS-DSCH category 11
- FRC H-Set 5 for UE of HS-DSCH category 12
- RC H-Set 6 (added in Release 6) and FRC H-Set 3 for UE of HS-DSCH category 7 and 8

HSDPA Transmitter Conformance Tests

Several tests of the transmitter characteristics have been added in the specifications to account for the addition of the HS-DPCCH in the uplink:

- Maximum Output Power with HS-DPCCH (34.121 5.2A)
- Transmit On/Off Power – HS-DPCCH (34.121 5.7A)
- SEM with HS-DPCCH (34.121 5.9A)
- ACLR with HS-DPCCH (34.121 5.10A)
- EVM with HS-DPCCH (34.121 5.13.1A)

The new HSDPA transmitter tests are mainly variations of R99 W-CDMA tests and are used to verify whether the transmitter can handle the addition of the uplink HS-DPCCH. Recall that the HS-DPCCH increases the PAR of the uplink signal, is not transmitted continuously in most cases, and can be offset in time from the DPCCH. These aspects of the HS-DPCCH pose some challenges for the transmitter.

The following HSDPA transmitter conformance tests must therefore be performed with the HS-DPCCH:

- Maximum Output Power test, similar to the standard R99 W-CDMA Maximum Output Power test, but with relaxed output power requirements to enable continued use of R99 power amplifiers with the higher PAR signal
- New power-versus-time mask to verify the accuracy of the uplink power steps when the bursted HS-DPCCH is transmitted (note that the actual test is called “Transmit On/Off Power – HS-DPCCH” in the specifications)
- SEM test and an ACLR test, similar to the standard R99 W-CDMA SEM and ACLR tests, to verify that the transmitter is operating correctly at the reduced maximum output power with the higher PAR signal
- EVM test to verify that the transmitter is operating correctly at the reduced maximum output power with the higher PAR signal. This test should also verify the impact of large HS-DPCCH power steps in the middle of DPCCH/DPDCH slots on the DPCCH/DPDCH signal quality

Test-specific downlink parameters The following table complements the general downlink test configuration table (Table 1) presented earlier. Here, only the downlink channel configuration test parameters that are specific to the HSDPA transmitter tests are shown.

Downlink channels	Level vs. Ior	Notes
DPCH	-9 dB	12.2 k RMC
HS-SCCH-1	-8 dB	HS-SCCH-2, 3, 4 are off (DTX)
HS-DSCH (HS-PDSCHs)	-3 dB	FRC H-Set 1

For these tests, the downlink HS-DSCH is configured as FRC H-Set 1 regardless of the UE category, since FRC H-Set 1 uses an inter-TTI of 3, which all the UE support.

The power levels selected for the DPCH, HS-SCCH-1, and HS-DSCH must be high enough to keep the UE's DTX reporting ratio very small and to ensure that the radio link is maintained during the test.

Note that this downlink signal is needed to establish and maintain an HSDPA connection at an inter-TTI interval of 3, but the specific details of the downlink signal configuration are not important for the purpose of transmitter testing and should not affect the results.

Uplink test configuration

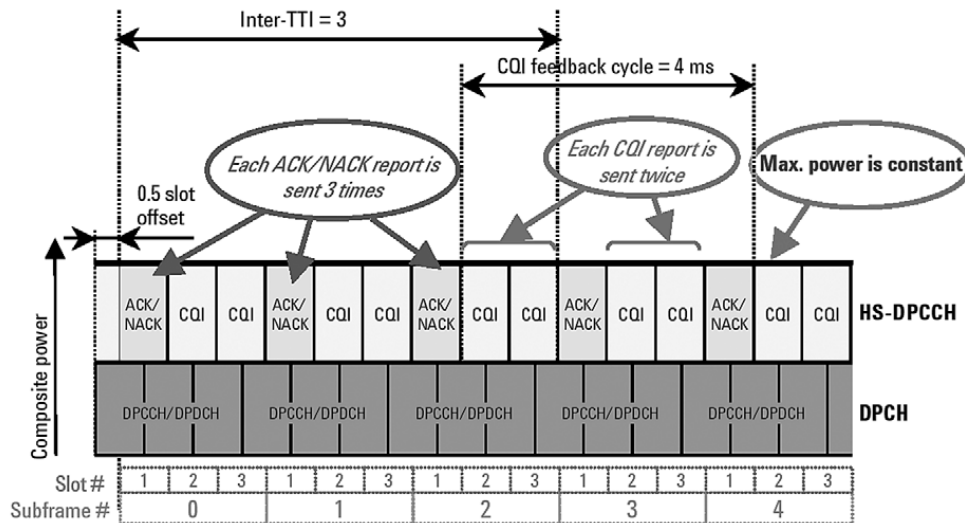
All five HSDPA transmitter tests use a similar uplink configuration, which is defined in 3GPP TS 34.121 appendix C.10. One of the objectives of the tests is to verify that HSDPA operation does not interfere with standard operation. For this reason, all the HSDPA tests use a DPCCCH and a DPDCH, configured as a standard uplink 12.2 kb/s RMC, in addition to the HS-DPCCH.

In general, a single HS-DPCCH configuration is chosen for all UE categories to limit the number of variables without affecting the results. For example, an inter-TTI interval of 3 is selected because it is supported by all UE categories, even though many are capable of receiving blocks more frequently. A 50% (0.5 slot) time offset between the DPCCCH and the HS-DPCCH is used for all tests because this time offset is required for some tests, even though it is unimportant to others.

The code power ratios between the channels in the uplink test configuration depend on which of the six sets of beta factors defined in 3GPP TS 34.121 table C.10.1.4 are used.

In order to simplify the Maximum Output Power, ACLR, and SEM tests, the HS-DPCCH is configured to have continuous power for these tests, as illustrated in Figure 9. Note that these tests are all performed at maximum power.

Figure 4-24 Generic Uplink Test Signal is Used for Maximum output power, SEM, and ACLR Tests



The inter-TTI is 3, so the ACK/NACK repetition factor ($N_{\text{acknack_transmit}}$) is set to 3 to avoid DTX ACK/NACK fields. The CQI feedback cycle (k) is arbitrarily set to 4 ms and the CQI repetition factor ($N_{\text{cqi_transmit}}$) is set to 2, which avoids DTX CQI fields.

The power-versus-time (HSDPA Transmit On/Off Power) test uses a more complex uplink signal with discontinuous HS-DPCCH power. As of September 2005, the uplink signal for the EVM test remains undefined but will probably use an HS-DPCCH with a power step.

Transmit On/Off Power – HS-DPCCH (34.121 5.7A)

Power-versus-time (officially called Transmit On/Off Power – HS-DPCCH in the specifications) is an important transmitter test that verifies the accuracy of the power steps caused by the addition of the HS-DPCCH. The transmit power template for this test is given in the following figure. The test is based on a 50% overlap between the DPCCH and the HS-DPCCH timeslots.

The length of any two adjacent power evaluation periods equals 2560 chips. In all cases the evaluation of mean power must exclude a 25 ms period before and after any DPCCH or HS-DPCCH slot boundary.

According to 3GPP TS 34.121 table 5.7A.2 of the specifications, this test is repeated using the beta factors defined in 3GPP TS 34.121 table C.10.1.4 for sub-tests 5 and 6, which are the most challenging sets in the table.

ACLR and SEM with HS-DPCCH (34.121 5.9A and 5.10A)

ACLR is the power from the carrier that shows up in adjacent and alternate 5 MHz channels. SEM is similar to ACLR but the measurement bandwidth is 30 kHz close in and 1 MHz further out.

The test procedures for ACLR and SEM differ from those of R99 in only one significant way: the HSDPA uplink test signal configuration based on the DPCCH + DPDCH + HS-DPCCH.

EVM with HS-DPCCH (34.121 5.13.1A) and Phase Discontinuity

One of the biggest challenges for HSDPA transmitters is to ensure that the UE is transmitting the DPCCH + DPDCH correctly when the HS-DPCCH turns on or off during the DPCCH slot. A possible source of error is the AM to PM distortion caused by having a 7 dB step change in power during a DPCCH slot. If this power step occurs near the UE maximum power level, distortion of the output phase may result, making demodulation by the BTS very difficult.

You can use the existing W-CDMA phase discontinuity measurement to give an indication of whether the performance of a particular UE design is likely to be susceptible to HS-DPCCH power steps.

Under the current W-CDMA requirements, non-HSDPA phase discontinuity is determined by measuring the change in phase between any two adjacent timeslots. Phase transients of up to 30 degrees are allowed only at DPCCH/DPDCH slot boundaries. EVM is measured for each timeslot, excluding the transient periods of 25 μ s on either side of the nominal timeslot boundaries. The frequency, absolute phase, absolute amplitude, and chip clock timing used to minimize the error vector are chosen independently for each timeslot. The phase discontinuity result is defined as the difference between the absolute phase used to calculate EVM for the preceding timeslot and the absolute phase used to calculate EVM for the succeeding timeslot.

Downlink configuration of HARQ transmissions

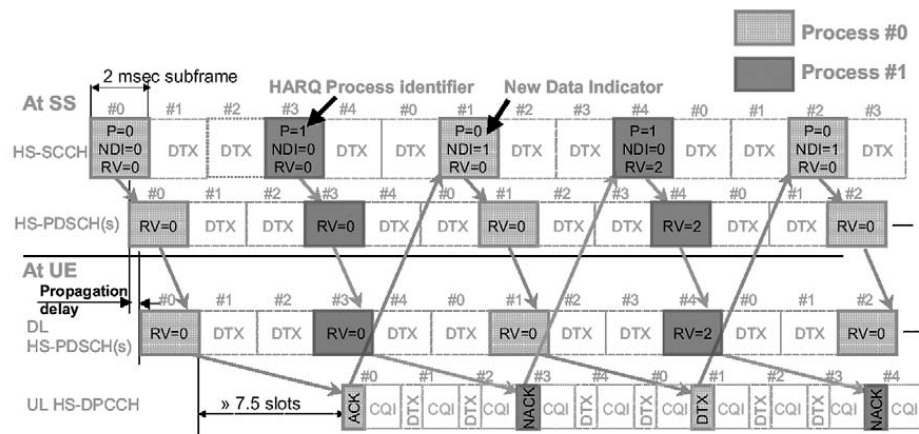
The following table shows the expected behavior of the SS in response to an ACK/NACK, as described in the Demodulation of HS-DSCH conformance test specifications. Here the objective is to simulate the behavior of the Node B. Upon receiving an ACK, the SS must send a new block of data. Upon receiving a NACK, however, it must send a retransmission using the next redundancy version (RV), up to the maximum number of HARQ transmissions allowed. Upon receiving a DTX, the SS must retransmit the same block of data using the same RV previously transmitted for that HARQ process. The RV defines the exact set of bits that are selected during rate-matching (puncturing) to be sent over the air at the time of any one transmission. Thus different RVs represent different puncturing schemes.

HS-DPCCH ACK/NACK field state	Node B emulator behavior
ACK	ACK: new transmission using first redundancy version (RV)
NACK	NACK: retransmission using the next RV (up to the maximum permitted number or RVs)
DTX	DTX: retransmission using the RV previously transmitted to the same HARQ process

The following table shows additional HS-DSCH configuration parameters for the Demodulation of HS-DSCH test. At the most, four HARQ transmissions are allowed, so three retransmissions are allowed. The RV sequence to follow is also specified and depends on the FRC modulation format. For QPSK configurations, RV = 0 is always sent in the first transmission of a block. The RVs 2, 5, and 6 are sent in subsequent retransmissions. For 16QAM configurations, RV = 6 is used for the first transmission and RVs 2, 1, and 5 in subsequent retransmissions. In an FRC all the coding and modulation parameters (except for the RV parameter) are fixed, so the number of bits that are sent over the air is always the same. The only difference between transmissions of the same block using different RVs is which set of bits is sent.

Other HS-DSCH configuration parameters	Value	Notes
Maximum # of HARQ transmissions	4	3 retransmissions allowed
Redundancy/constellation version (RV) sequence	{0, 2, 5, 6} {6, 2, 1, 5}	QPSK configurations 16QAM configurations

The following simplified graphic shows the interaction between the SS and the UE during the Demodulation of HS-DSCH test. This example uses FRC H-Set 1 (QPSK), which has two processes and an inter-TTI interval of three.



The downlink HS-SCCH indicates that new data is being transmitted from the SS by toggling the new data indicator (NDI) value between 0 and 1 within the same HARQ process (see 3GPP TS 25.321 clause 11.6.1.3). Thus, for a retransmission, the NDI value stays the same while the RV changes to the next in the sequence. To keep this example simple, we allow a maximum of two HARQ transmissions per block, rather than the four transmissions that are allowed for the actual Demodulation of HS-DSCH test. The RV sequence is {0, 2}.

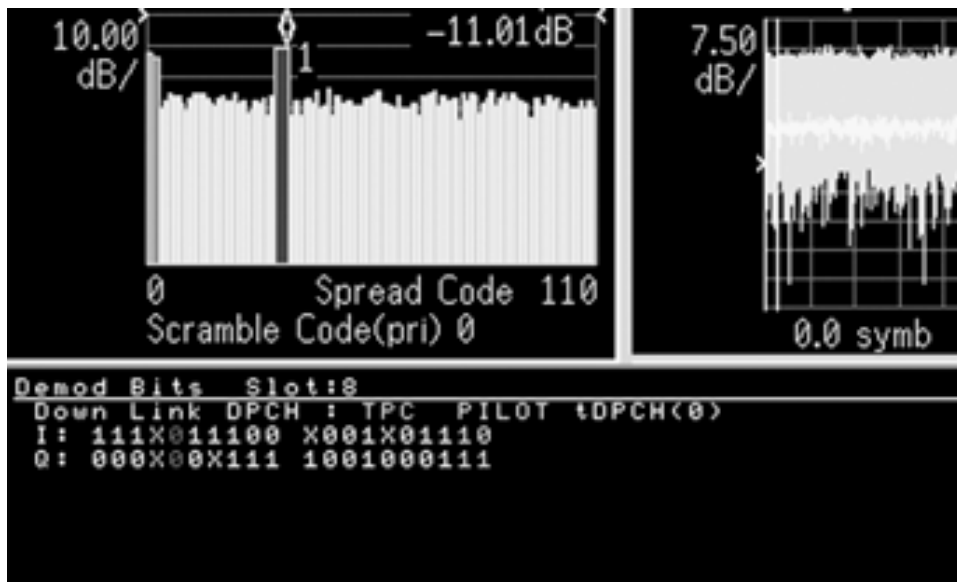
Note that if a NACK is received for the first block sent for process #1, the SS answers by maintaining the NDI as 0 and changing the RV from 0 to 2. This response indicates that the original data block is being retransmitted using a different RV.

Discontinuous transmission

Code channel amplitude can fluctuate during transmission. This is called DTX or discontinuous transmission. As a result, some bits are lost or not easily demodulate. W-CDMA combats this by replacing the lost bits with Xs so the operator can see which bits are lost.

Select Tri under the Bit Format key to represent the lost bits by an X. Choose the percent of the signal. For example, if 50 percent is chosen and a bit drops off to half of the signal, an X will replace the demodulated bit. The figure below is an example of how Xs are added in place of demodulated bits.

Figure 4-26 X's Used to Replace Demodulated Bits



In the 3GPP standard, compressed mode signals have several power-off slots during the transmission. This power-off period prevents active channel identification in code domain. Without identification as active channels, tDPCH (timing offset of DPCH from CPICH) cannot be detected. This means that the slot boundary for a code channel is not correctly identified, which in turn means the demodulation bits and code channel power are affected. Setting tDPCH manually helps to examine the signal in compressed mode correctly because of adjusted slot boundary.

HSUPA Concepts

What is HSUPA?

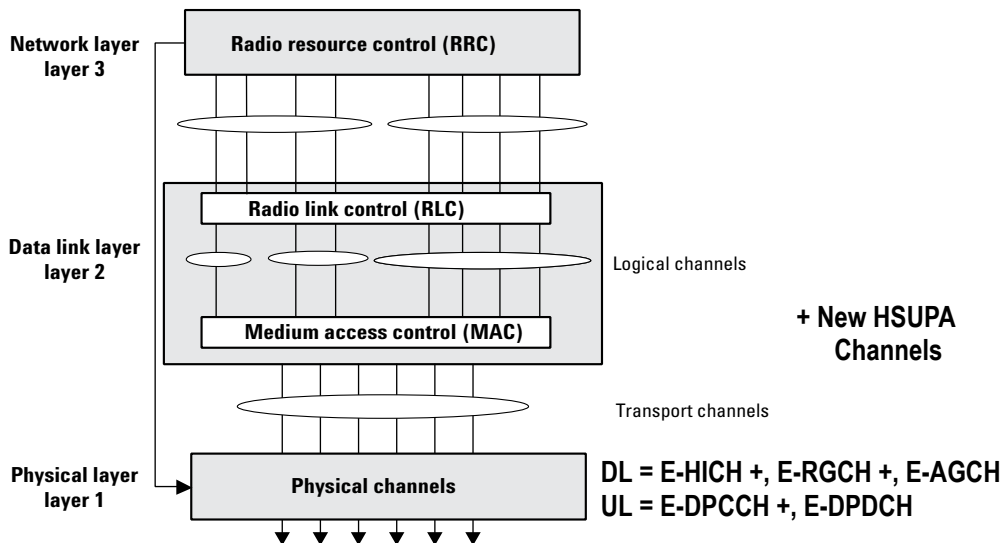
High Speed Uplink Packet Access (HSUPA) is a digital packet communications format that employs 3GPP-defined Enhanced Data Channels (E-DCH) that support high speed data transmission within the existing W-CDMA communications system. Appropriate uses for HSUPA are UL data bit streams like those employed for digital photography, video, music, games or other high-speed MS applications.

HSUPA is a packet-based data service that supports data transmission rates up to 5.7 Mbps within a 3.84 MHz bandwidth WCDMA uplink. HSUPA implementations as defined by 3GPP include Soft Handover, Hybrid Automatic Rate reQuest (HARQ), as low as 2ms TTI, and Fast Node B scheduling.

Protocol Structure

The protocol structure of the HSUPA system is the same as the W-CDMA protocol structure. HSUPA employs existing W-CDMA logical channels, but uses different transport and physical layer channels. [Figure 4-27](#) shows the three lower W-CDMA layers, and the corresponding HSUPA channels in the Physical Layer.

Figure 4-27 W-CDMA Protocol Structure w/ HSUPA Channel Overlay



For more information about the W-CDMA Protocol Structure see [“Protocol Structure”](#) on page 403.

HSUPA Logical, Transport, and Physical Channels

HSUPA cooperates with existing W-CDMA transport channels to support sharing physical resources between multiple services. Each service, such as data, fax, voice, or signaling, is routed into different transport channels by the upper signaling layers. These services may have different data rates and error control schemes. The transport channels are then multiplexed as required prior to transmission via one or more physical channels. High data rate services or a combination of lower rate transport channels are then multiplexed into several physical channels.

HSUPA also cooperates with non-enhanced W-CDMA UL and DL physical channels. The most important UL and DL physical channels that are used with HSUPA are the Dedicated Physical Control Channels (DPCCH). For more information on W-CDMA channels see [“Logical Transport and Physical Channels” on page 404](#).

HSUPA Downlink E-CDH Physical Channels

E-CDH Absolute Grant Channel (E-AGCH)

The E-CDH Absolute Grant Channel (E-AGCH) is a shared channel created for HSUPA to control E-DPDCH absolute transmissions. The E-AGCH is for downlink signaling and associated scheduling from the serving cell only. The serving E-DCH cell is the one from which the UE receives Absolute Grants from the Node-B scheduler. A UE has only one serving E-DCH cell. For more information see [“HSUPA Cell Connection Overview” on page 453](#).

The E-AGCH is a fixed rate (30kbps, SF=256) downlink physical channel carrying the uplink E-DCH absolute grant.

An E-DCH absolute grant is transmitted over one E-AGCH sub-frame or one E-AGCH frame. The transmission over one E-AGCH sub-frame and over one E-AGCH frame is used for UEs for which E-DCH TTI is set to 2 ms and 10 ms respectively.

E-CDH HARQ Indicator Channel (E-HICH)

The E-CDH HARQ Indicator Channel (E-HICH) is a dedicated channel created for HSUPA to carry HARQ Feedback to the UE. The E-HICH is for associated ACK/NACK signaling from the Node B.

The E-DCH Hybrid ARQ Indicator Channel (E-HICH) is a fixed rate (SF=128) dedicated downlink physical channel carrying the uplink E-DCH hybrid ARQ acknowledgement indicator.

A hybrid ARQ acknowledgement indicator is transmitted using 3 or 12 consecutive slots and in each slot a sequence of 40 binary values is transmitted. The 3 and 12 slot duration shall be used for UEs which E-DCH TTI is set to respectively 2 ms and 10 ms.

In a radio link set (RLS) containing the serving E-DCH radio link set, the hybrid ARQ acknowledgement indicator a is set to +1 or -1 (ACK or NACK), and in a radio link set not containing the serving E-DCH radio link set the hybrid ARQ indicator is set to +1 or 0 (ACK or NACK).

Table 4-5 Mapping of HARQ Acknowledgement

Command	HARQ acknowledgement indicator
ACK	+1
NACK (RLSs not containing serving E-CDH cell)	0
NACK (RLSs containing serving E-CDH cell)	-1

E-CDH Relative Grant Channel (E-RGCH)

The E-CDH Relative Grant Channel (E-RGCH) is a dedicated channel created for HSUPA to control E-DPDCH relative transmissions. The E-RGCH is for downlink signaling and associated scheduling from E-DCH active set. The E-DCH active set is the set of cells which carry the E-DCH for one UE. The E-DCH Relative Grant Channel (E-RGCH) is a fixed rate (SF=128) dedicated downlink physical channel carrying the uplink E-DCH relative grants.

A relative grant is transmitted using 3, 12 or 15 consecutive slots and in each slot a sequence of 40 ternary values is transmitted. The 3 or 12 slot duration is used on an E-RGCH transmitted to UEs when the cell transmitting the E-RGCH is in the E-DCH serving radio link set (RLS), and when the E-DCH TTI is respectively 2 and 10 ms. The 15 slot duration is used on an E-RGCH transmitted to UEs when the cell transmitting the E-RGCH is not in the E-DCH serving radio link set. In a serving E-DCH radio link set, the relative grant value is set to +1, 0, or -1 (Up, Hold, or Down) and in a radio link not belonging to the serving E-DCH radio link set, the relative grant value is set to 0 or -1 (Hold, or Down).

Table 4-6 Mapping of Relative Grant (RG) Values

Command	RG Value (serving E-DCH RLS)	RG Value (other radio links)
UP	+1	Not Allowed
HOLD	0	0
DOWN	-1	-1

For more information see [“HSUPA Cell Connection Overview”](#) on page 453.

For more information about Downlink physical channels see the corresponding W-CDMA section [“Downlink Physical Channels”](#) on page 406.

HSUPA Uplink Physical Channels

Dedicated Physical Data and Control Channels (DPDCH/DPCCH)

The Dedicated Physical Channel (DPCH) is used for HSDPA in the same manner as for other W-CDMA traffic. It carries all the user data and user signaling, as well as physical channel control bits for the slot format and the UE inner loop power control. The DPCH consists of the DPDCH and the DPCCH. The user’s digitized voice and/or digital data, along with layer 3 signaling data, are carried on the DPDCH. The user data and signaling data are individually treated with error protection coding and interleaving, then multiplexed together to form the DPDCH. The DPDCH is then multiplexed with the DPCCH, which contains the Transmit Power Control (TPC) bits (to control the UE transmit power), Transport Format Combination Indicator (TFCI) bits (indicates the slot format and data rate), and embedded Pilot bits (short synchronization patterns embedded within each slot).

A maximum of 6 DPDCH and 1 HS-DPCCH channels may be used in an uplink transmission in what is known as HSUPA Configuration 1. See [“Allowable HSUPA Uplink Physical Channel Configurations”](#) on page 451.

E-CDH Dedicated Physical Control Channel (E-DPCCH)

The E-CDH Dedicated Physical Control Channel (E-DPCCH) is a dedicated channel created for HSUPA that carries control information associated with the E-CDH. There is at most one E-DPCCH on each radio uplink. See [“Allowable HSUPA Uplink Physical Channel Configurations”](#) on page 451.

Each E-DPCCH radio frame is divided in 5 subframes, each of length 2 ms; the first subframe starts at the start of each radio frame and the 5th subframe ends at the end of each radio frame. The E-DPCCH is not transmitted in a slot unless the DPCCH is also transmitted in the same slot. The E-DPCCH slot format (only 0 is available) is shown in [Table 4-7](#).

Table 4-7 E-DPCCH Slot Format

Slot Format #i	Channel Bit Rate (kbps)	SF	Bits/ Frame	Bits/ Subframe	Bits/Slot N_{data}
0	15	256	150	30	10

The following information is transmitted by means of the E-DPCCH physical channel:

- Retransmission Sequence Number (RSN) (2bits) - To indicate the redundancy version (RV) of each HARQ transmission and to assist the Node B soft buffer management, a two bit RSN is signaled from the UE to the Node B. The Node B can avoid soft buffer corruption by flushing the soft buffer associated to one HARQ process in case more than 3 consecutive E DPCCH transmissions on that HARQ process can not be decoded or the last received RSN is incompatible with the current one.
- E-TFCI information (7bits)
- “Happy” bit (1bit) - This is a single bit field that is passed from MAC to the physical layer for inclusion on the E-DPCCH. This field takes two values, “Not Happy” and “Happy” indicating respectively whether the UE could use more resources or not: whether or not the UE is satisfied (‘happy’) with the current Serving Grant.

E-DCH Dedicated Physical Data Channel (E-DPDCH)

The E-CDH Dedicated Physical Channel (E-DPDCH) is a dedicated channel created for HSUPA that carries uplink data. There is at most four E-DPDCH on each radio uplink. See “[Allowable HSUPA Uplink Physical Channel Configurations](#)” on page 451.

The E-DPDCH and the E-DPCCH are always transmitted simultaneously, except for the case where E-DPDCH is DTXed, but E-DPCCH is not DTXed, due to power scaling. The E-DPDCH slot formats, corresponding rates and number of bits are shown in Table

Table 4-8 E-DPDCH slot formats

Slot Format #i	Channel Bit Rate (kbps)	SF	Bits/ Frame	Bits/ Subframe	Bits/Slot N_{data}
0	15	256	150	30	10
1	30	128	300	60	20
2	60	64	600	120	40
3	120	32	1200	240	80
4	240	16	2400	480	160

Table 4-8 E-DPDCH slot formats

Slot Format #i	Channel Bit Rate (kbps)	SF	Bits/ Frame	Bits/ Subframe	Bits/Slot N_{data}
5	480	8	4800	960	320
6	960	4	9600	1920	640
7	1920	2	19200	3840	1280

HSUPA Dedicated Physical Channel Uplink Configurations

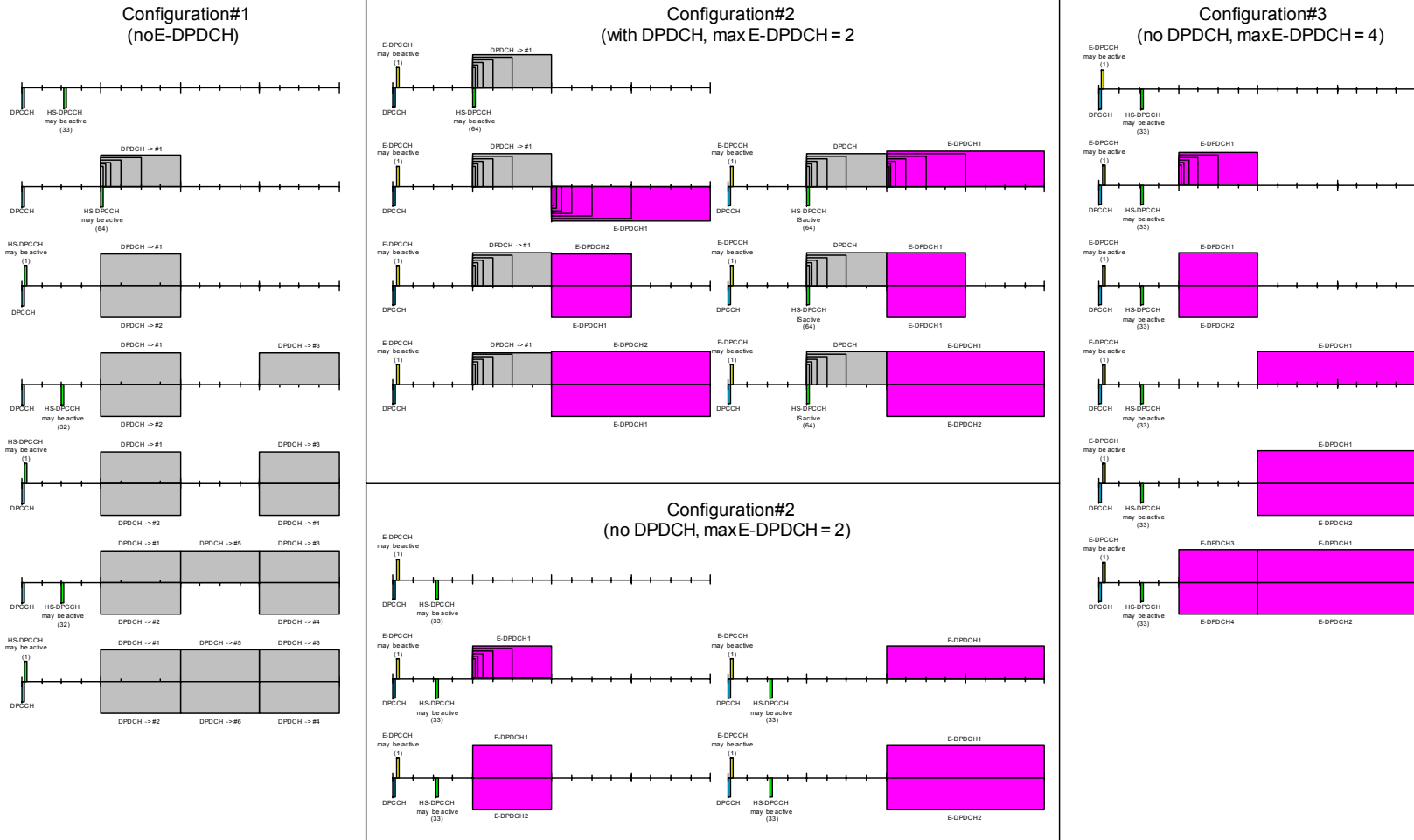
In addition to the DPCCH/DPDCH and the HS-DPCCH, all allowed HSUPA uplink channel configurations permitted by 3GPP Release 6 are shown in the following table.

The following configurations are also used to set up the DPCH Configuration for the Code Domain Power measurement of a HSUPA signal. The **DPCH/E-DPCH Config** menu is part of the **Meas Setup** menu for the Code Domain Measurement/

Table 4-9 Allowable HSUPA Uplink Physical Channel Configurations

Configuration Number	DPDCH	HS-DPCCH	E-DPDCH	E-DPCCH
1	6	1	0	0
2	1	1	2	1
2 (no DPDCH)	0	1	2	1
3	0	1	4	1

Figure 4-28 HSUPA DPCH/E-DPCH Code Domain Channels by Configuration Number



Revision 2. 11/25/2005
DPCH E-DPCH config.vsd

HSUPA Uplink Data Rates

HSUPA achieves various data rates as required by varying the number of data channels and their respective spreading factors. The maximum theoretical data rate that can be attained with HSUPA is 5.76 Mbps, using the maximum number of data channels and the highest spreading factors, as shown in the table below.

Table 4-10 HSUPA Effective Data Rates in Mbps by Channels Used and SF

Effective Coding Rate	Number of Data Channels / Spreading Factor (SF)			
	1 @ SF4	2 @ SF4	2 @ SF2	2 @ SF4 + 2 @ SF2
1/2	480 Mbps	960 Mbps	1920 Mbps	2880 Mbps
3/4	720 Mbps	1440 Mbps	2880 Mbps	4320 Mbps
4/4	950 Mbps	1920 Mbps	3840 Mbps	5760 Mbps

Details of the code domain channel assignments for each of the various data channel configurations are shown in [Figure 4-28 on page 452](#).

For information about Uplink physical channels see the corresponding W-CDMA section “[Uplink Physical Channels](#)” on page 408.

HSUPA Cell Connection Overview

In [Figure 4-29 on page 454](#) and [Table 4-29 on page 454](#) the following E-DCH conditions apply:

- E-DCH active set: The set of cells which carry the E-DCH for one UE.
- Serving E-DCH Cell: Cell from which the UE receives Absolute Grants from the Node-B scheduler. A UE has one Serving E-DCH Cell.
- Serving E-DCH Radio Link Set (RLS): Set of cells which contains at least the Serving E-DCH cell and from which the UE can receive and combine one Relative Grant. The UE has only one Serving E-DCH RLS. Also called a “Serving RLS”.
- Non-Serving E-DCH Radio Link (RL): Cell which belongs to the E-DCH active set but does not belong to the Serving E-DCH RLS and from which the UE can receive one Relative Grant. The UE can have zero, one or several Non-serving E-DCH RL(s). Also called a “Non-serving RL”.

Concepts

Figure 4-29 HSUPA Cell Connection Diagram

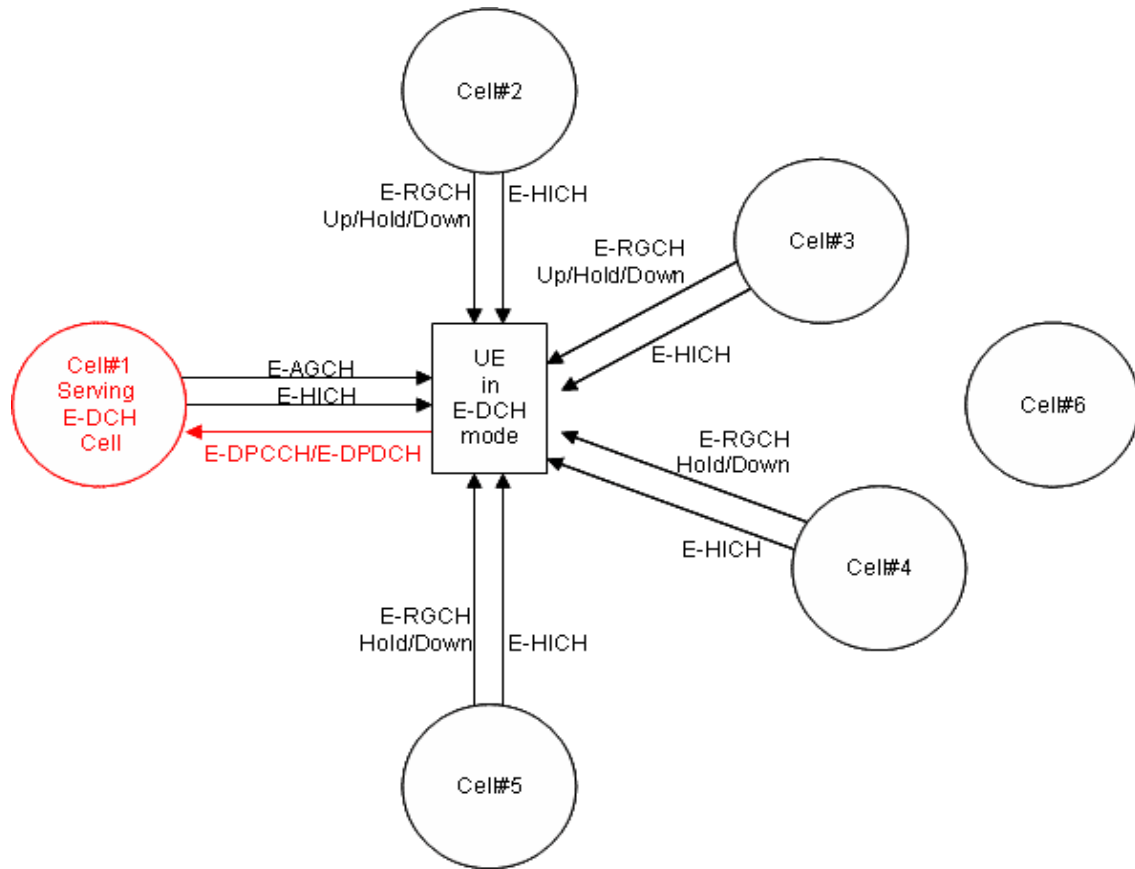


Table 4-11 HSUPA Cell Connections

Cell Number	E-DCH Active Set?	Serving E-DCH RLS?	Non-serving E-DCH RL?
1 (Serving E-DCH cell)	X	X	
2	X	X	
3	X	X	
4	X		X
5	X		X
6			

Adjacent Channel Power Ratio (ACPR/ACLR) Measurement Concepts

Purpose

Adjacent Channel Power Ratio (ACPR), as it applies to W-CDMA (3GPP), is the power contained in a specified frequency channel bandwidth relative to the total carrier power. It may also be expressed as a ratio of power spectral densities between the carrier and the specified offset frequency band. This is also called Adjacent Channel Leakage power Ratio (ACLR).

As a composite measurement of out-of-channel emissions, ACPR combines both in-band and out-of-band specifications to provide useful figures-of-merit for spectral regrowth and emissions produced by components and circuit blocks without the rigor of performing a full spectrum emissions mask measurement.

To maintain a quality call by avoiding channel interference, it is important to measure and reduce any adjacent channel leakage power transmitted from a mobile phone. The characteristics of adjacent channel leakage power are mainly determined by the transmitter design, particularly the low-pass filter.

What Is Adjacent Channel Interference?

Depending on the context, the acronym ACP(R) has been taken to mean either adjacent channel power (ratio), which is a transmitter measurement or adjacent channel protection (ratio), which is a receiver measurement. To resolve this ambiguity, 3GPP has introduced three new terms: adjacent channel leakage power ratio (ACLR), adjacent channel selectivity (ACS), and adjacent channel interference ratio (ACIR).

ACLR is a measure of transmitter performance. It is defined as the ratio of the transmitted power to the power measured after a receiver filter in the adjacent RF channel. This is what was formerly called adjacent channel power ratio.

ACS is a measure of receiver performance. It is defined as the ratio of the receiver filter attenuation on the assigned channel frequency to the receiver filter attenuation on the adjacent channel frequency.

ACIR is a measure of overall system performance. It is defined as the ratio of the total power transmitted from a source (BTS or UE) to the total interference power resulting from both transmitter and receiver imperfections affecting a victim receiver. ACIR is mainly of interest in network simulation where the total amount of interference, rather than the source of the interference, is the primary concern. This is what was formerly called adjacent channel protection ratio.

The following equation shows the relationship between ACIR, ACLR, and ACS:

Equation 4-1

$$\text{ACIR} = \frac{1}{\frac{1}{\text{ACLR}} + \frac{1}{\text{ACS}}}$$

The main source of adjacent channel leakage (ACL) is non-linear effects in the power amplifiers (PA). It directly affects the co-existing performance of systems on adjacent channels. Power leakage is a general noise pollution and degrades performance of the system in the adjacent channel. If sufficiently bad, it causes the so called “near-far” problem, where a UE simply cannot communicate with a far away BTS because of high ACL from a nearby adjacent channel UE. Network planning can address this problem, but the associated costs depend directly on the stringency of the ACLR specification. So, we have conflicting needs. From an equipment design perspective, a relaxed ACLR specification is attractive, whereas from a network planning perspective, low ACL is very desirable.

Measurement Method

This ACPR measurement analyzes the total power levels within the defined carrier bandwidth and at given frequency offsets on both sides of the carrier frequency. This measurement requires the user to specify measurement bandwidths of the carrier channel and each of the offset frequency pairs up to 5. Each pair may be defined with unique measurement bandwidths.

It uses an integration bandwidth (IBW) method that performs a time domain data acquisition and applies FFT to get a frequency domain trace. In this process, the channel integration bandwidth is analyzed using the automatically defined resolution bandwidth (RBW), which is much narrower than the channel bandwidth. The measurement computes an average power of the channel over a specified number of data acquisitions, automatically compensating for resolution bandwidth and noise bandwidth.

ACLR (or ACPR) is commonly measured using a signal analyzer or measuring receiver. In the measurement, filtering is applied to both the power in the main frequency channel and the power in the adjacent channel. An important factor for ACLR is the specification of the measurement filter, including its bandwidth and shape. Original W-CDMA specifications called for a rectangular filter, but this has now changed to a RRC filter with a –3 dB bandwidth equal to the chip rate [12]. This provides an closer indication to real-life performance. However, it requires the instrument to apply precise filter weighting.

If **Total Pwr Ref** is selected as the measurement type, the results are displayed as relative power in dBc and as absolute power in dBm. If **PSD Ref** (Power Spectral Density Reference) is selected, the results are displayed as relative power in dB, and as absolute power in dBm/Hz.

Recommended Offset Frequencies and Reference Bandwidths

While the user sets the specific offsets and reference bandwidths, the radio specifications recommend some common setups as shown in the following table.

Table 4-12

ACPR Setup Recommendation

Band	Test Device	Offset Frequency	Integration Bandwidth	Result Reference
W-CDMA (3GPP)	Mobile or Base	±5.000 MHz	3.840 MHz	Total Power in 3.840 MHz
		±10.000 MHz	3.840 MHz	

Channel Power Measurement Concepts

Purpose

The Channel Power measurement is a common test used in the wireless industry to measure the total transmitted power of a radio within a defined frequency channel. This procedure measures the total power within the defined channel for W-CDMA (3GPP). This measurement is applied to design, characterize, evaluate, and verify transmitters and their components or devices for base stations and mobile stations.

Measurement Method

The Channel Power measurement reports the total transmitted power within the channel integration bandwidth, 5.00 MHz for the W-CDMA 3GPP mode. The measurement acquires a number of points representing the input signal in the time domain. It transforms this information into the frequency domain using FFT and then calculates the channel power. The effective resolution bandwidth of the frequency domain trace is proportional to the number of points acquired for FFT. The fastest FFT process is achieved using a number of acquired points that is a power of 2 (for example: 64, 128, 512).

Since the measurement is optimized for speed and accuracy, you are permitted to change only the number of acquired data points in powers of 2, not the actual resolution bandwidth which is shown in gray. However, if absolute sweep time is required, it can be changed to the user's specific value at the expense of reduced speed. At no time will both sweep time and data points be set to manual because of conflicting parameter settings. This flexibility is available through the **Advanced** menu of the channel power measurement.

To improve repeatability, you can increase either the number of averages or the number of data points with longer time record length. The channel power graph is shown in the graph window, while the absolute channel power in dBm and the mean power spectral density in dBm/Hz are shown in the text window.

For E4406A Option B7C, this measurement is available for use with either the RF input or baseband I/Q inputs. For detailed operation, see the "Using Option B7C Baseband I/Q Inputs" section.

Code Domain Measurement Concepts

Purpose

What is the Code Domain?

Code domain power is an analysis of the distribution of signal power across the set of code channels, normalized to the total signal power. To analyze the composite waveform, each channel is decoded using a code-correlation algorithm. This algorithm determines the correlation coefficient factor for each code. Once the channels are decoded, the power in each code channel is determined.

Since the code domain measurements despread and descramble the W-CDMA (3GPP) signal into its physical channels, the number of active channels of various symbol rates (which are denoted by widths) can be observed. The width of the channel is inversely proportional to the Orthogonal Variable Spreading Factor (OVSF) code length in number of bits. In the code domain, there is a fixed amount of code space for a given chip rate. Therefore, by using the different OVSF codes, the system can dynamically allocate the code space for lower rate voice users versus high speed data users.

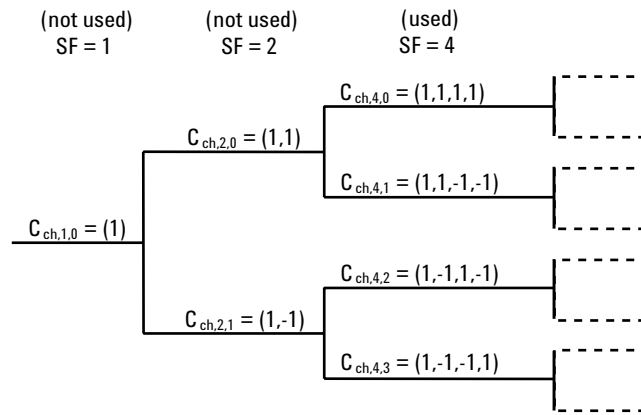
The code domain power composite view provides information about the in-channel characteristics of the W-CDMA (3GPP) signal. It directly informs the user of the active channels with their individual channel powers. The composite view also shows which data rates are active and the corresponding amount of code space used. The following are conditions under which a general unlock can occur: the DPCCH signal is too low in power or no such signal available for MS measurements, an incorrect long code is used for despreading, the frequency error is too large, or a frequency inversion is present.

When the level of the code domain noise floor is too high, relative to a reference or an expected level, one of the possible causes might be due to CW interference, like local oscillator feedthrough or spurs. I/Q modulation impairments can be another source of this uncorrelated noise. The I/Q demodulation measurements can reveal errors such as I/Q gain imbalance or I/Q quadrature error.

In W-CDMA, the measurement is complicated by the fact that the length of the OVSF codes, or SF, varies to accommodate the different data rates. As the user rate increases the bit period becomes shorter. Since the final chip rate is constant, fewer OVSF code chips are accommodated within the bit period—the SF becomes smaller. The SF can be 4, 8, 16, 32, 64, 128, or 256, corresponding to DPDCH bit rates from 960 kbps down to 15 kbps¹.

1. The bit rate for the DPCCH is fixed at 15 kbps.

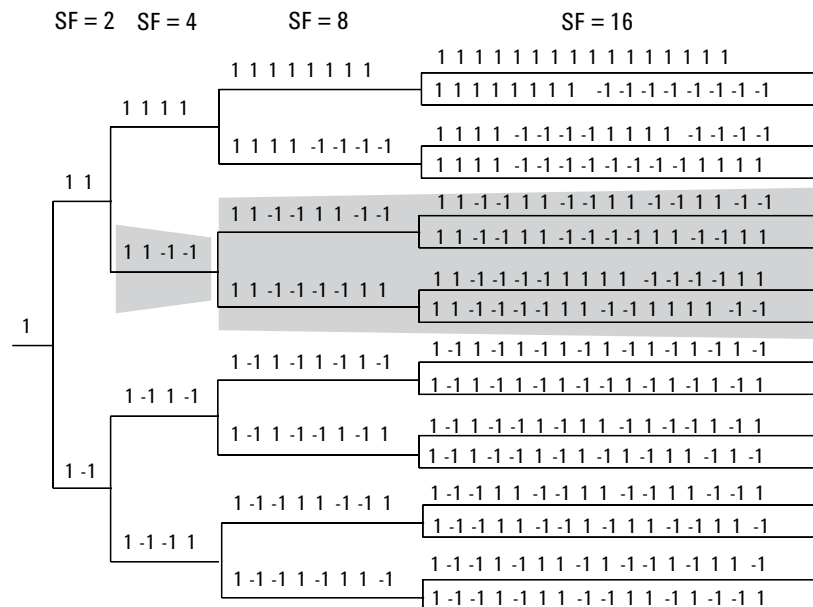
Figure 4-30 Code Tree Generation of OVFSF codes [3]



Seven sets of spreading codes are specified, one set for each SF. The OVFSF codes can be allocated using the code tree shown in [Figure 4-30 on page 460](#). Each code is denoted by $C_{ch,SF,n}$. For example, $C_{ch,4,2}$ means channelization code, $SF = 4$, code number 2.

In this tree, OVFSF codes of a certain SF are obtained by copying the “mother-branch” code of the previous SF and repeating or inverting it. For example, $C_{ch,4,2} = (1,-1,1,-1)$ is obtained by repeating $C_{ch,2,1} = (1,-1)$, while $C_{ch,4,3} = (1,-1,-1,1)$ is obtained by copying $C_{ch,2,1} = (1,-1)$ and inverting it. This code generation technique is known as reverse-bit method.

Figure 4-31 Effects of using variable SFs



One of the consequences of using variable SFs is that a shorter code precludes using all longer codes derived from it. If a high data rate channel using a code of SF = 4 (1, 1, -1, -1) is selected, all lower data rate channels using longer OVSF codes that start with 1, 1, -1, -1 have to be inactive because they are not orthogonal. (See [Figure 4-31 on page 460](#))

For the UL, as shown earlier, the physical channels are I/Q multiplexed. A special scrambling function (HPSK) is applied to limit the Peak-to-Average Ratio (PAR). However, HPSK limits the choice of OVSF codes. In order to benefit from HPSK, the OVSF codes must consist of pairs of consecutive identical chips. For example, Cch,4,1 = (1,1,-1,-1) would meet this condition, but Cch,4,2 = (1,-1,1,-1) would not [8].

Careful choice of OVSF codes can lead to lower PAR. Exhaustive simulations using CCDF curves (see earlier section) led to the following specifications for the OVSF codes [9]:

- The DPCCH is always spread by code Cch,256,0 = (1,1,1,1,1,...).
- When only one DPDCH is to be transmitted, it is spread by code Cch,SF,SF/4 = (1,1,-1,-1,1,1,-1,-1...).

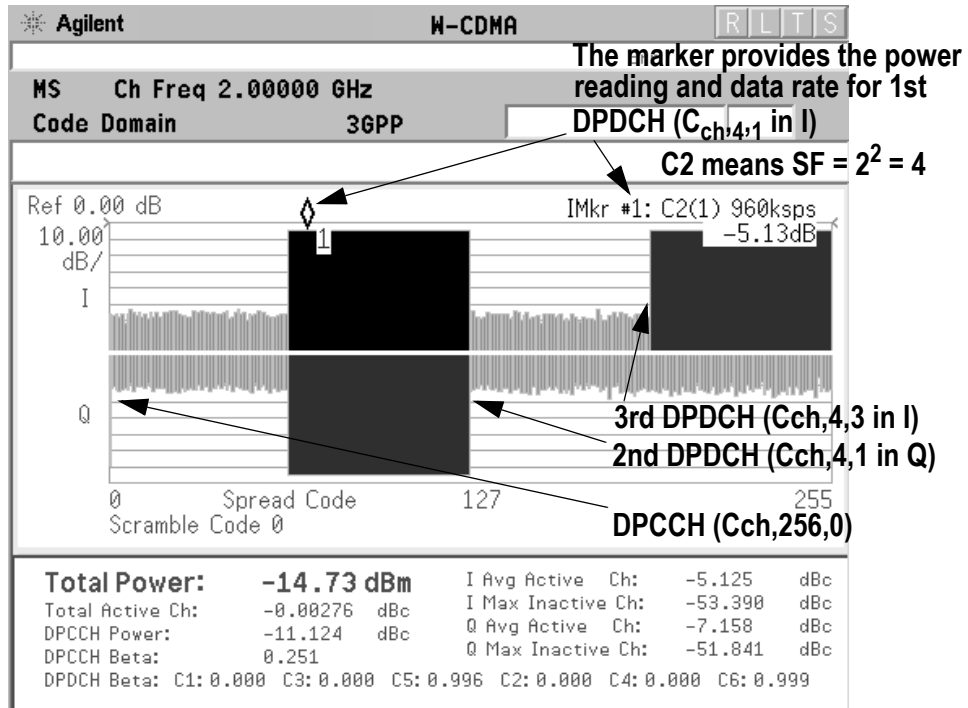
When more than one DPDCH is to be transmitted (because of high data rates), all DPDCHs have SFs equal to four. Two DPDCHs can share the same code, since one will be in I and the other one in Q, which makes them orthogonal. The channelization codes for the DPDCHs are defined as:

- Cch,4,1 = (1,1,-1,-1) for the first and second DPDCHs
- Cch,4,3 = (1,-1,-1,1) for the third and fourth DPDCHs
- Cch,4,2 = (1,-1,1,-1) for the fifth and sixth DPDCHs

Even though the OVSF codes were selected to maximize the benefits of HPSK, the HPSK requirements will be completely fulfilled only for the first two DPDCHs. The worst case of PAR will be when five or six channels are required to cover the high data rates. It is expected that this will only occur a small percentage of the time. However, this does not make solving the problem easier for the amplifier designer.

In terms of code capacity, channels with higher data rates (lower SF) occupy more code space. For example, Cch,4,1 occupies two times more code space than Cch,8,2, and four times more code space than Cch,16,4. The wider bars in the code domain power display represent codes with low SF that occupy more code space. [Figure 4-32](#) shows the code domain power display for a signal with a DPCCH and three DPDCHs. The three DPDCH (at 960 kbps, SF = 4) are much wider than the DPCCHs (at 15 kbps, SF = 256). In order to provide this display, the analyzer must be able to identify the SFs of the code channels being measured.

Figure 4-32 Code Domain Power of W-CDMA UL Signal with 1 DPCCH and 3 DPDCHs



The code domain power measurement helps you not only verify that each OVSF channel is operating at its proper amplitude, but also identify problems throughout the transmitter design from the coding to the RF section. In particular, the levels of the inactive channels can provide useful information about specific impairments. Ideally, the levels for the inactive channels would be zero. In reality, signal and system imperfections compromise the code orthogonality and result in a certain amount of signal power projecting onto inactive codes. A real signal will also have a certain noise level, which being random, will project more or less evenly onto all codes.

The projection of the error is interesting because it enables you to see how the error power is distributed in the code domain. You want the error power to be evenly distributed throughout the code domain, rather than concentrated in a few codes, to avoid code-dependent channel quality variations.

One possible cause of uneven distribution of error power is LO instability. In essence, energy is lost from the active channels and appears in those channels with codes that are closely related to the active channel codes [16]. In the case of OVSF codes, this results in higher code domain noise for channels with code assignments consecutive to the active channel code, whether they are at the same or at a different I/Q path.

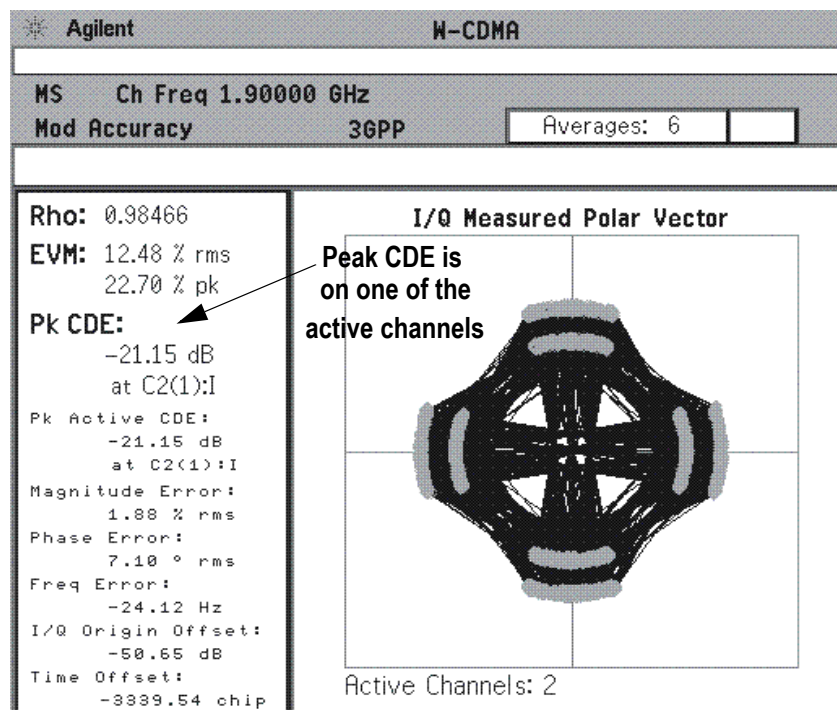
Peak Code Domain Error

In W-CDMA, specifically to address the possibility of uneven error power distribution, the composite EVM measurement has been supplemented by another test called peak code domain error that specifies a limit for the error power in any one code.

This test is required for BTS and UE in which multi-code transmission is provided. In the case of UE, the UE must be configured with the UL 768 kbps reference measurement channel (which is the only UL reference measurement channel with two DPDCHs). In the case of BTS, the BTS must be configured with the DL at 30 kbps (Test Model 3). The error vector power must be projected on each code channel with a SF of 4 for UE and 256 for BTS. The peak code domain error is then calculated from the code that returns the largest error power relative to the composite reference signal. The error must not exceed -15 dB.

Figure 4-33 on page 463 shows the peak code domain error, in combination with the composite EVM, for the same signal (UL 768 kbps reference measurement channel) with the LO instability problem above. In this case, the peak code domain error falls in an active code channel. The result of the measurement coincides with the peak active code domain error, which calculates the error only in the active code channels.

Figure 4-33 Peak Code Domain Error and Composite EVM display for W-CDMA UL Signal (one DPCCH and two DPDCHs), Effect of High Local Oscillator Instability Shown



Symbol EVM

Apart from looking at the code domain power and peak code domain error, it is useful to analyze a specific code channel. The following sections describe some analysis tools and how they can be applied. [Figure 4-37](#) shows how these measurements are calculated.

By descrambling and despreading the signal you can analyze the constellation and EVM for a specific code channel at the symbol level, even in the presence of multiple codes. The measured signal is HPSK descrambled and despread. The phase trajectory of the ideal symbol reference is then calculated and compared to the trajectory of the measured despread symbols ([Figure 4-37](#)).

An impairment that affects symbol EVM will also affect the composite EVM. For example, an amplifier compression problem will appear both in the composite EVM and in the symbol EVM measurement. However, because of the spreading gain symbol EVM will mute the impairment. So why use symbol EVM?

Symbol EVM provides the bridge between RF and demodulated bits. Since it includes the spreading gain, it provides a measure of modulation quality closer to real-life performance. In this sense, you can think of symbol EVM as the actual quality the user in that channel will experience (similar to the reciprocal of the bit error rate).

The relationship between symbol EVM and chip EVM depends on the SF. At low SFs (high data rates) chip modulation errors have a significant effect on symbol EVM. But at high SFs, chip modulation errors have little effect on symbol EVM. In this sense, it is particularly useful to baseband digital signal processing (DSP) engineers to evaluate symbol quality and analyze how specific impairments affect the quality of channels at different data rates.

For example, in [Figure 4-34 on page 465](#), on the left is shown a code domain power measurement of a W-CDMA UL signal with a high-frequency phase error problem, with the DPCCCH and the marker on the one DPDCH at 15 kbps (Cch,256,64). On the right is shown another similarly impaired W-CDMA UL signal, with the marker on the DPDCH at 480 kbps (Cch,8,2).

In [Figure 4-35](#), the I/Q Polar Vector graphs of the channels marked in the above CPD presentation are shown. In the case of the higher data rate signal on the right, the constellation distortion is more apparent. A **Meas Interval** of 30 slots was selected for this measurement.

Finally, [Figure 4-36](#) shows the Peak and Average symbol EVM for both signals. The symbol EVM for the lower data rate channel is much lower than that of the higher data rate channel.

Figure 4-34 CDP w/ DPDCH at 15 kbps (Left) & DPDCH at 480 kbps (Right)

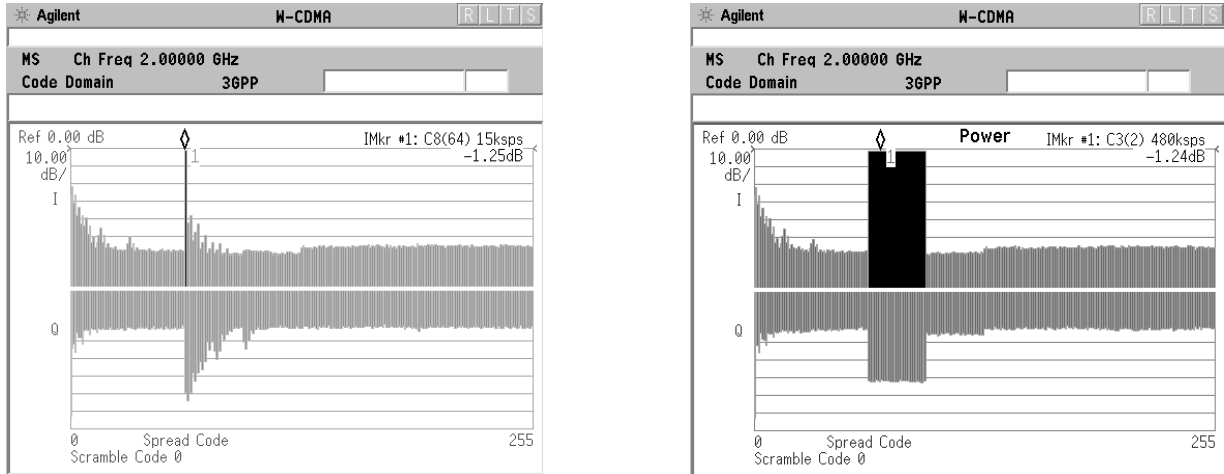


Figure 4-35 I/Q Polar Vector of DPDCH at 15 kbps (Left) & 480 kbps (Right)

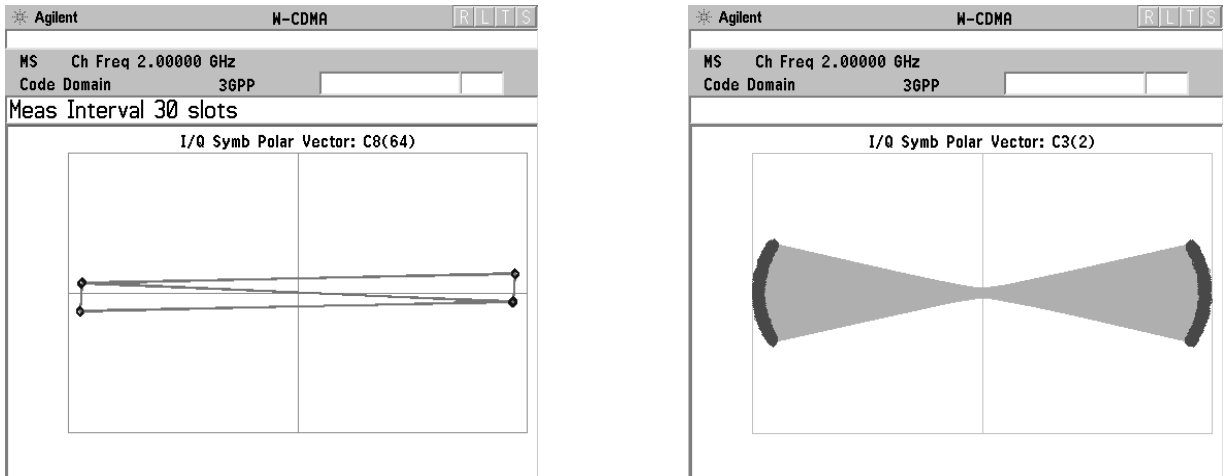


Figure 4-36 Symbol EVM of DPDCH at 15 kbps (Left) & 480 kbps (Right)

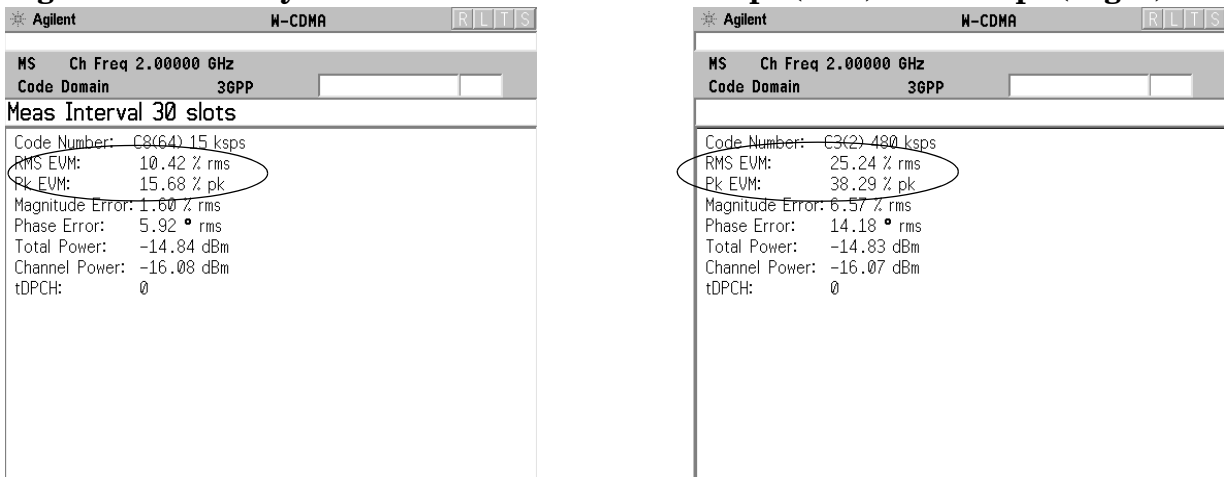
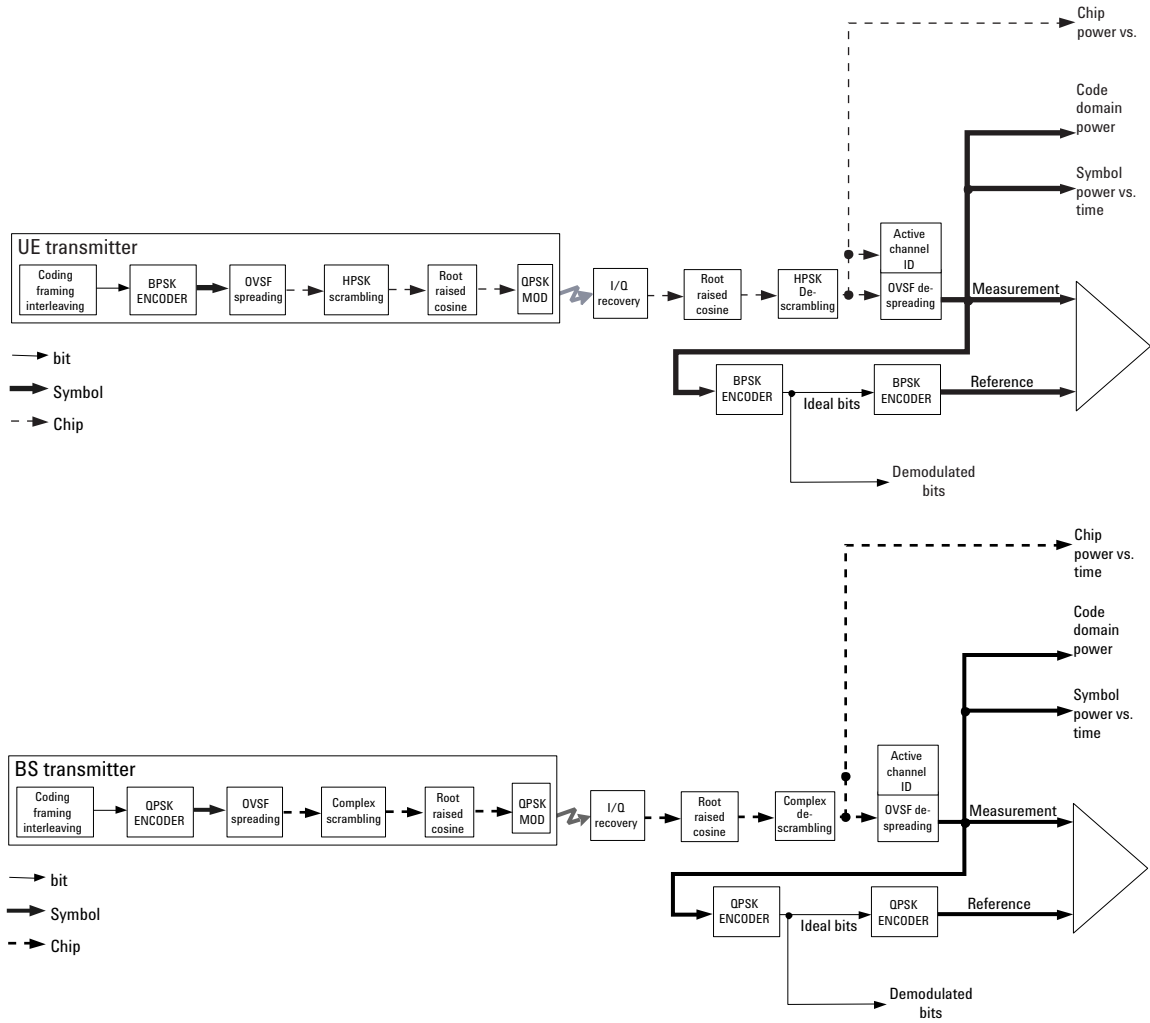


Figure 4-37 Process to Calculate Code Domain Power, Symbol EVM, Symbol

Concepts

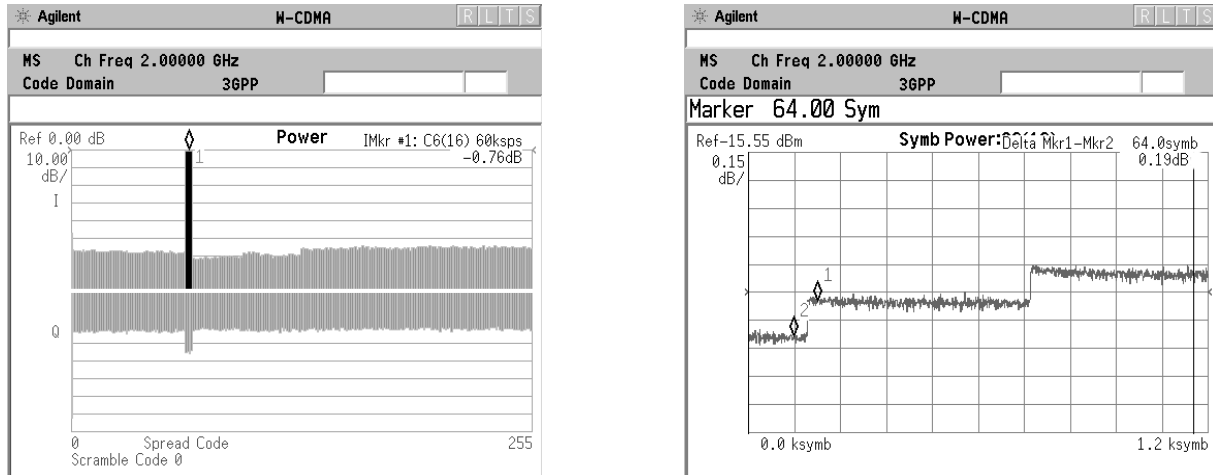
**Power vs. Time, Chip Power vs. Time, and Demodulated Bits
US (UL) above, BS (DL) below**



Symbol Power versus Time (PvT)

Analyzing the symbol power for a specific code channel versus time can be particularly useful to monitor the power and response of the UE power control system for different code channels (See [Figure 4-38](#)).

Figure 4-38 W-CDMA UL w/DPCCCH, one DPDCH at 60 kbps (Cch,64,16) CDP View (left) and Symbol EVM measurement View (right)



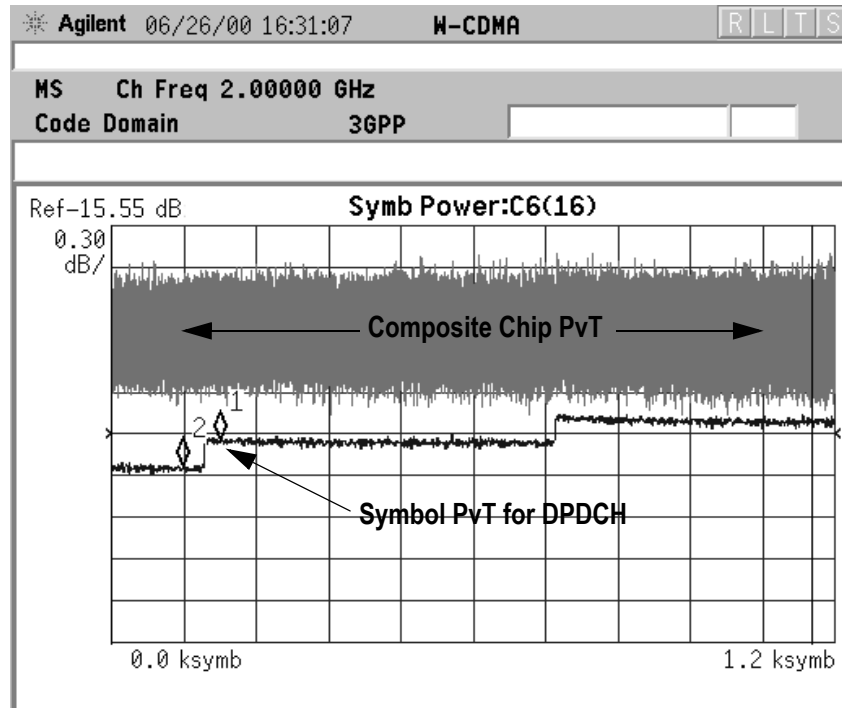
The CDP display on the left shows a marker (#1) on the DPDCH, and the same marker is positioned on the DPDCH portion of the Symbol PvT view at the right. Both views are available simultaneously in the **Code Domain (Quad View)**, under the **View/Trace** menu.

[Figure 4-39 on page 468](#) shows the despread symbol power in combination with the composite (total) chip power for an UL signal. Chip power represents the total power of the signal at the chip rate. Analyzing the symbol power for a channel in combination with the total chip power versus time is particularly useful for system integrators to analyze the power amplifier response (ripple) to a power control command.

To view this combination display, you must select **Display, Composite Chip Power, ON**.

Concepts

Figure 4-39 Chip PvT for W-CDMA UL w/ DPCCH, one DPDCH at 60 kbps (Cch,64,16), combined with Symbol PvT for the DPDCH (Cch,64,16)



Demodulated Bits

By obtaining the demodulated bits after HPSK descrambling and despreading for each code channel (I for the DPDCH and Q for the DPCCH, for the basic configuration), the correct bit patterns can be verified. As shown in Table 1, the UL DPCCH can have different slot structures. You can verify if the bits for the different fields (Pilot, TPC, etc.) are correct by using the demodulated bits measurement (Figure 4-40 on page 469).

Analyzing demodulated bits enables baseband engineers to identify coding and interleaving errors. In many cases, it can help you clarify situations where the BTS and UE are having problems communicating with each other. Analyzing the demodulated bits may verify whether the error is coming from the UE coding and interleaving, or the BTS de-interleaving and decoding process.

Figure 4-40 Demod Bits View for the DPCCH (slot format 0) of a W-CDMA UL signal w/ DPCCH, one DPDCH at 60 kbps (Cch,64,16)

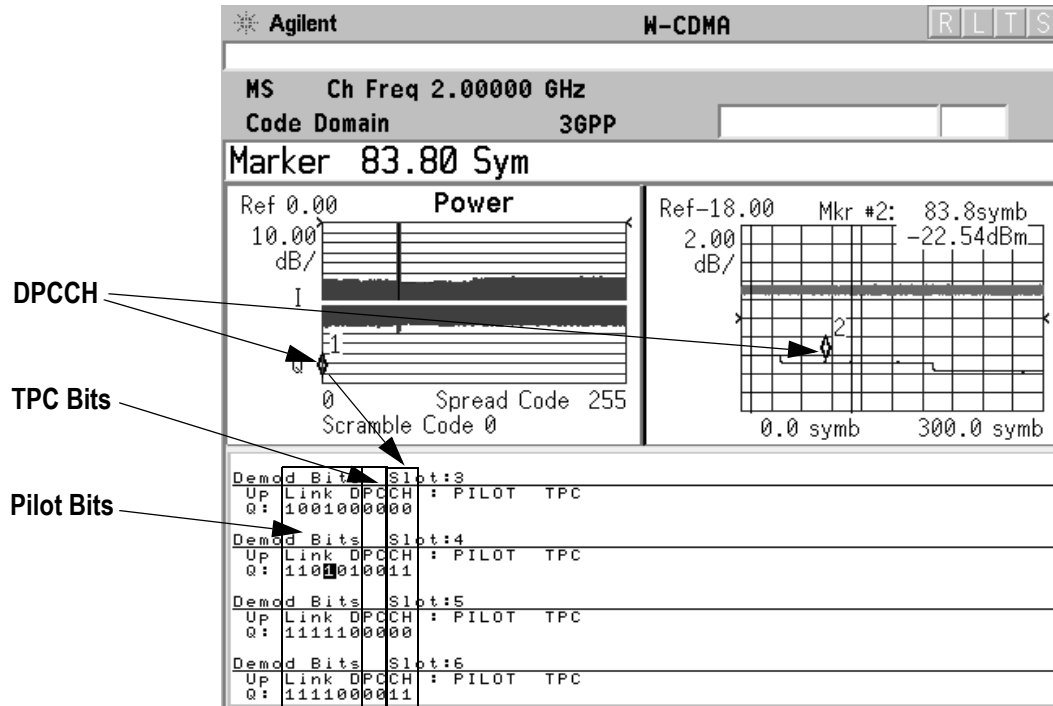


Table 4-13 W-CDMA DPCCH Fields (Uplink)

Slot Format	Channel Bit Rate (kbps)	Channel Symbol Rate (ksps)	SF	Bits Per Frame	Bits Per Slot	Npilot	NTPC	NTFCI	NFBI
0	15	15	256	150	10	6	2	2	0
1	15	15	256	150	10	8	2	0	0
2	15	15	256	150	10	5	2	2	1
3	15	15	256	150	10	7	2	0	1
4	15	15	256	150	10	6	2	0	2
5	15	15	256	150	10	5	1	2	2

Concepts

Table 4-14 W-CDMA DPDCH and DPCCH Fields (Downlink)

Slot Format	Channel Bit Rate (kbps)	Channel Symbol Rate (ksps)	SF	Bits Per Slot	DPDCH Bits/Slot		DPCCH Bits/Slot		
					Ndata1	NData2	NTTPC	NTFCI	NPilot
0	15	7.5	512	10	0	4	2	0	4
1	15	7.5	512	10	0	2	2	2	4
2	30	15	256	20	2	14	2	0	2
3	30	15	256	20	2	12	2	2	2
4	30	15	256	20	2	12	2	0	4
5	30	15	256	20	2	10	2	2	4
6	30	15	256	20	2	8	2	0	8
7	30	15	256	20	2	6	2	2	8
8	60	30	128	40	6	28	2	0	4
9	60	30	128	40	6	26	2	2	4
10	60	30	128	40	6	24	2	0	8
11	60	30	128	40	6	22	2	2	8
12	120	60	64	80	12	48	4	8	8
13	240	120	32	160	28	112	4	8	8
14	480	240	16	320	56	232	8	8	16
15	960	480	8	640	120	488	8	8	16
16	1920	960	4	1280	248	1000	8	8	16

Concepts

Active Channel Detection

NOTE

Symbol Boundary selections are only available if **Mode Setup, Radio** is set to DL.

Active channel detection selections are available to allow you to determine how the instrument detects W-CDMA active channels. There are three choices available under the **Meas Setup, Symbol Boundary** menu:

- **Auto** - Use this setting to detect active channels automatically based on the entire **Capture Intvl** (Interval) setting.
- **Predefined Test Models** - Test Models 1 through 5 may be selected to assure correct active channel detection if you are using these models.

You should use the **Auto** setting when measuring HSDPA signals that employ Adaptive Modulation Control (AMC). With AMC, the modulation scheme changes dynamically between QPSK and 16QAM, so the **AUTO** detection algorithm cannot correctly calculate the difference, or EVM, between the reference and vector symbols. With **Auto** you can select the symbol boundary that defines which slots may be detected as containing active channels. Use the **Meas Offset** and **Meas Interval** settings to define these slots so only one modulation scheme is present in a measurement interval.

Modulation Scheme Selection

Modulation scheme selections are available to allow you to determine how the instrument demodulates detected W-CDMA active channels. There are three choices available under the **Meas Setup, Mod Scheme** menu:

NOTE

Mod Scheme selections are only available if **Mode Setup, Radio** is set to DL and **Meas Setup, Symbol Rate** is set to 240 ksps.

- **Auto** - Use this setting to specify detected active channels will be automatically examined to determine modulation scheme based on the assumption the modulation scheme for ALL channels remains constant throughout the entire **Capture Intvl** (Interval) setting. When this criteria is met, this setting offers the most stable detection results.
- **QPSK** - The code channels specified by the **Symbol Rate** and **Code Number** settings are known to be QPSK modulated.
- **16QAM** - The code channels specified by the **Symbol Rate** and **Code Number** settings are known to be 16QAM modulated.

You should use the **Auto** setting when measuring HSDPA signals that employ Adaptive Modulation and Coding (AMC). With AMC, the modulation scheme changes dynamically between QPSK and 16QAM, so the **AUTO** detection algorithm cannot correctly calculate the difference, or EVM, between the reference and vector symbols. With **Auto** you can select the symbol boundary that defines which slots may be detected as containing active channels. Use the **Symbol Rate** and **Code Number** settings to define these channels so only one modulation scheme is present in a measurement interval.

Measurement Method

This procedure measures the power levels of the spread channels in composite RF channels. For BTS tests, the symbol based sync type is available for defining any channel code to synchronize with. Therefore, CPICH and SCH are not always required for synchronization. If **Device** is set to **MS**, the demodulated I and Q signals are individually shown in the code domain power graph window. Unlike most of the other measurements, the default setting for **Measure** in the **Meas Control** menu is **Single** for this measurement.

The code domain measurement displays the power for each of the spread channels. This power is relative to the total power within the 3.840 MHz channel bandwidth and centered around the center frequency. Each spread channel level is displayed as an individual vertical bar with a different width determined by a spread rate. Because this is a relative measurement, the default unit of measure is dBc. **Meas Type** toggles the power unit between **Abs** (absolute) and **Rel** (relative).

For E4406A, Option B7C, in addition to RF input signals, baseband I/Q input signals can be measured using the Option B7C “Baseband I/Q Inputs”.

Depending on the selection of the **View/Trace** menu, two to four display windows are available with different combinations of measurement results. [Table 4-15](#) shows the combinations for the signal capture time settings and the view/trace selections.

Table 4-15 Combinations of Display Windows

Capture Interval	View/Trace	Display Windows			
		Window 1	Window 2	Window 3	Window 4
1, 3 Slots and 1, 2, or 3 frames	CDP Graph & Metrics	CDP (Code Domain Power)	Summary Metrics	(not available)	(not available)
	CDP Graph & CDE Graph	CDP (Code Domain Power)	CDE (Code Domain Error)	(not available)	(not available)
	I/Q Error (Quad View)	Mag Error vs. Symbol	Phase Error vs. Symbol	Symbol EVM Polar Graph	Summary Metrics
	Demod Bits	Code Domain Power	Symbol Power vs. Time	Demod Bits	(not available)
4 or 8 frames	Demod Bits	Symbol Power vs. Time (wider view)	Demod Bits	(not available)	(not available)

When the **View/Trace** is set to **Power Graph & Metrics**, the metrics window shows the group of various channel power levels for BTS and MS tests as shown in [Table 4-16 on page 474](#), according to the setting of **Capture Interval**, **Symbol Boundary**, and **Composite** under the **Display** key.

Table 4-16 Code Domain Channel Power Metrics

Capture Interval	Symbol Boundary Composite	Power Metrics (excepting Num of Active Ch)			
		BTS		MS	
1, 3 slots or 1, 2, or 3 frames	Auto, Composite = On	Total Power Total Active Ch CPICH PSCH SSCH	Max Active Ch Avg Active Ch Max Inactive Ch Avg Inactive Ch Num of Active Ch	Total Power Total Active Ch DPCCH DPCCH Beta DPDCH Beta HS-DPCCH Beta ^a DPDCH Beta (C1 to C6) Num of Active Channels	I Avg Active Ch I Max Inactive Ch Q Avg Active Ch Q Max Inactive Ch
	Auto, Composite = Off	Total Power CPICH PSCH SSCH	Max Ch Avg Ch	Total Power DPCCH	I Max Ch I Avg Ch Q Max Ch Q Avg Ch

a. HS-DPCCH Bets is displayed only when “HSDPA Enable” is ON.

Intermodulation Measurement Concepts

Purpose

Intermodulation products are generated by nonlinear components or devices in an instrument where two signals are present, one desired and the other unwanted. This is a measure of intermodulation signals generated in a transmitters nonlinear elements, caused by the presence of the desired signal and an interfering signal reaching the transmitter via the antenna.

Measurement Method

The intermodulation measurement measures the third-order and fifth-order intermodulation products caused by the wanted signal and the interfering signal. These intermodulation products are generated by the nonlinear devices or circuits in a transmitter. The measured results are evaluated as a ratio, relative to the carrier power. 3GPP defines the transmit intermodulation as a measure of transmitter capability. There are two types of intermodulation:

- Two-tone - Measurements are made assuming two CW signals to be the tone signals.
- Transmit IM - Measurements are made assuming that one signal is the modulated transmitting signal and another is the CW tone signal.

This measurement automatically identifies either two-tone intermodulation mode or transmit intermodulation mode at the start of measurements. The fundamental signals, lower and upper, are automatically searched every sweep to calculate the proper results. When a measurement starts, the highest two peaks at frequencies f_0 and f_1 are searched within a given span. Based on these frequencies, the possible frequencies for third-order and fifth-order intermodulation products are calculated. The power bandwidth is checked to determine if the mode is two-tone or transmit intermodulation. To avoid erroneous measurement results, it is recommended that either the upper or lower signal is set to the center frequency. This will ensure that the internal attenuator in the automatic input range control mode will be used to make appropriate measurements.

The results are displayed both as relative power in dBc and as absolute power in dBm. For transmit intermodulation products, the result is also shown as the power spectral density in dBm/MHz.

Modulation Accuracy - (Composite EVM)

Purpose

In addition to the QPSK EVM and symbol EVM measurements, the composite EVM measurement is made to qualify a transmitter. QPSK EVM is for single channel analysis and does not take into account spreading and scrambling. Symbol EVM is for measuring a single coded channel. The composite EVM measurement is the modulation accuracy against the multi coded reference chip power through the spreading and scrambling circuits. For more basic information on Error Vector Magnitude measurements see [“QPSK EVM Measurement Concepts” on page 492](#).

Rho is one of the key modulation quality metrics, along with EVM and code domain power. Rho is the ratio of the correlated power in a multi coded channel to the total signal power. This measurement takes into account all possible error mechanisms in the entire transmission chain including: baseband filtering, I/Q modulation anomalies, filter amplitude and phase non-linearities, and power amplifier distortions. This provides an overall indication of the performance level of the transmitter of the UUT.

Although measuring EVM for a signal with a single DPDCH (or a DPDCH and a DPCCH) may be useful, in general, we are interested in the overall modulation quality of the transmitter for any channel configuration. The constellation of this signal will vary depending on its channel configuration. The measurement of choice in this case is the composite EVM measurement. It corresponds to the modulation accuracy conformance test specified in the 3GPP specifications [12].

To evaluate the modulation accuracy of a W-CDMA multi-channel signal, we again need to synthesize a reference signal. The signal under test is downconverted (the baseband I and Q signals are recovered) and passed through a root raised cosine receiver filter. Active channels are descrambled, despread, and is BPSK decoded to bits for UL signals (see [Figure 4-41 on page 477](#)), and QPSK decoded for DL signals (see [Figure 4-42 on page 477](#)).

Figure 4-41 Process to Calculate Composite EVM for W-CDMA UL Signal

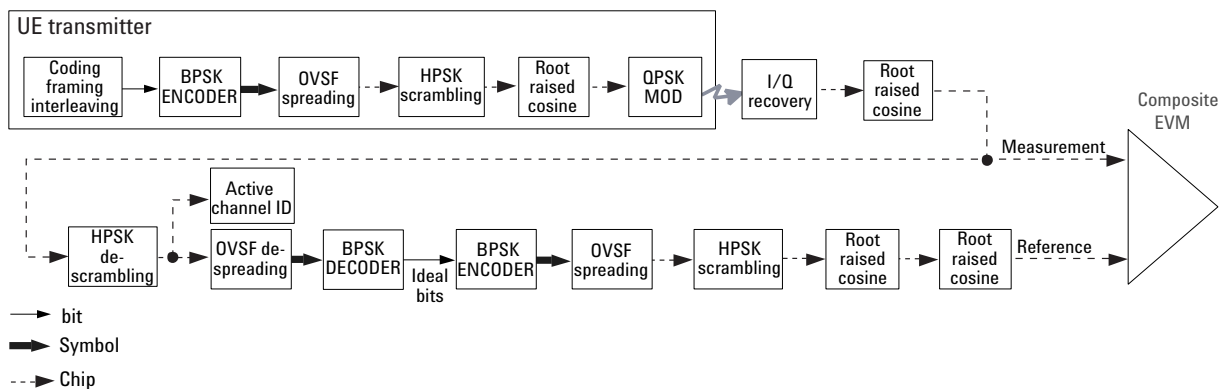
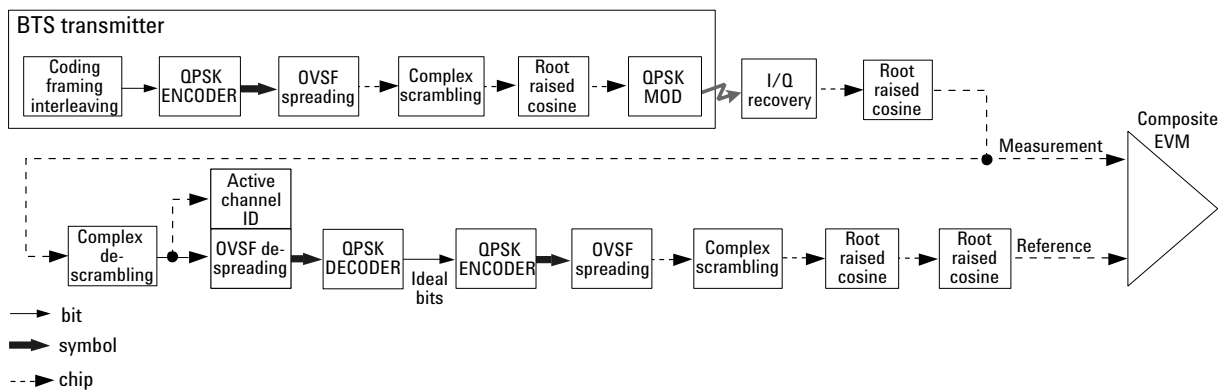


Figure 4-42 Process to Calculate Composite EVM for W-CDMA DL Signal



The despread bits are "perfectly" remodulated to produce the required reference signal at the chip level. The reference signal is then subtracted from the measured signal to produce a time record of error phasors. The square root of the ratio of the mean power of the error signal to the mean power of the reference signal is computed and expressed as a percentage EVM.

The composite EVM measurement accounts for all spreading and scrambling problems in the active channels and for all baseband, IF, and RF impairments in the transmitter chain.

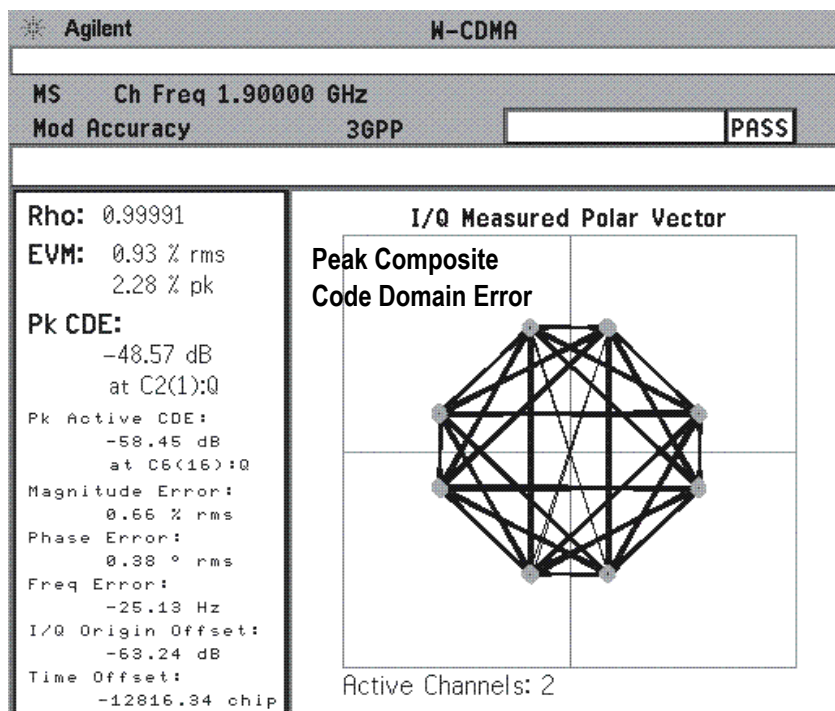
A coded signal with the DPCCH and at least one DPDCH is required to make a composite EVM measurement on a W-CDMA UL signal. A W-CDMA DL signal must contain either the SCH or the CPICH. Otherwise, the analyzer cannot demodulate the signal and calculate the appropriate reference. In that case, you can use QPSK EVM to measure the RF performance for limited channel configurations, as mentioned earlier.

Concepts

There are several situations where you will want to use the Composite EVM measurement (and its related vector diagram, phase error and magnitude error metrics, etc.), instead of a QPSK EVM measurement:

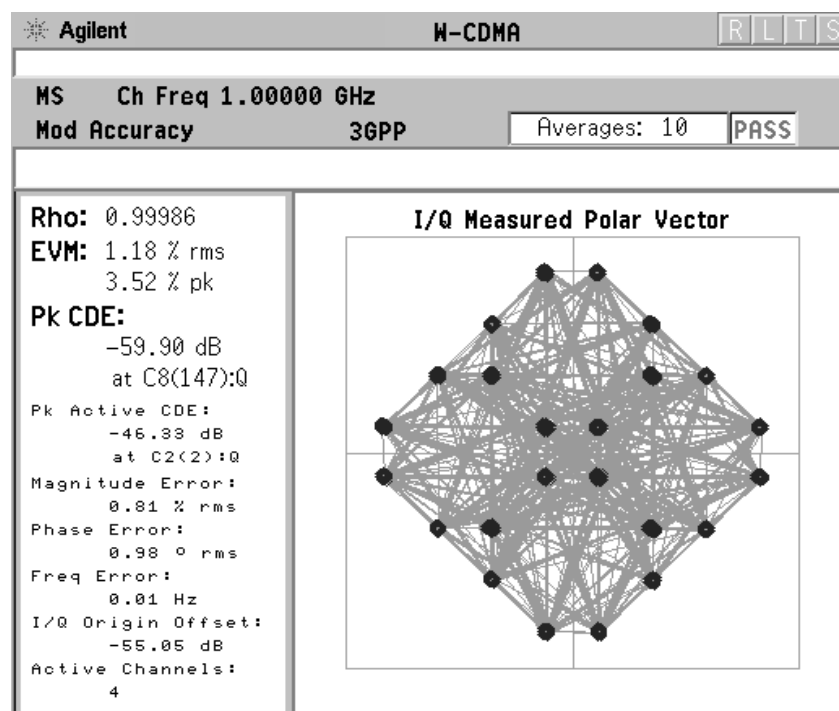
- 1. To evaluate the quality of the transmitter for a multi-channel signal. This is particularly important for RF designers, who need to test the RF section (or components) of the transmitter using realistic signals with correct statistics. In general, the peak-to-average power ratio of the signal increases as the number of channels increases. By measuring modulation quality on a multichannel signal you can analyze the performance of the RF design for W-CDMA UL signals with different levels of stress (different CCDFs). Evaluating the modulation quality of multi-channel signals is also important for the baseband designers to analyze the performance of multi-board baseband designs. For example, a small timing error in the clock synchronization between channels on different boards can be detected as a decrease in modulation quality. Figure 4-43 shows the composite EVM and vector diagram for the UL 12.2 kbps reference measurement channel, as required by the modulation accuracy test in the 3GPP specifications [12]. Figure 4-44 shows the composite EVM and vector diagram for a signal with the DPCCH and three DPDCHs.

Figure 4-43 Composite EVM and Vector Diagram for a W-CDMA Signal with UL 12.2 kbps Reference Measurement Channel (one DPDCH and a DPCCH)



- Use the composite EVM measurement to detect spreading or scrambling errors. Depending on the degree of the error, the analyzer may show an intermittent unlock condition or may not be able to lock at all when trying to perform a composite EVM measurement. This is mainly useful to system integrators to determine errors in the spreading and scrambling. If this problem occurs, you can use the QPSK EVM measurement to confirm that the rest of the transmitter is working as expected. If the scrambling or spreading error does not cause an unlock measurement condition, you can use the error vector versus time display to find the problematic chip.

Figure 4-44 Composite EVM and Vector Diagram for a W-CDMA UL Signal with 12.2 kbps Reference Measurement Channel (three DPDCHs and a DPCCH)



- Use the composite EVM measurement to detect certain problems between the baseband and RF sections. This is mainly useful for system integrators. You may be able to use QPSK EVM measurement to detect some of these problems. For example, LO instability caused by interference from digital signals can be detected with QPSK EVM. However, the QPSK EVM measurement will not detect problems that require the measurement to synchronize with a bit sequence. For example, I/Q swapped (reversed I and Q) errors will look perfectly normal if a QPSK EVM measurement is used. On the other hand, it will cause an unlock condition when performing a composite EVM measurement.

Composite EVM is useful throughout the development, performance verification, and manufacturing phases of the UE life cycle as a single figure of merit for the composite waveform as a whole. You will also be interested in the code-by-code composition of the multiplex. The primary means of investigating this is to look at the distribution of power in the code domain.

Measurement Method

A coded signal with the DPCCH and at least one DPDCH is required to make a composite EVM measurement on a W-CDMA UL signal.

The modulation accuracy measurement is made to get results for a composite error vector magnitude, rho, and code domain error from this difference. The code domain error is computed by projecting the error vector power onto the code domain at the maximum spreading factor. The error vector for each power code is defined as the ratio to the mean power of the reference waveform expressed in dB. Rho values are in the range of 0 to 1. A value of 1 indicates perfect correlation to the reference (high modulation quality).

For E4406A, Option B7C, in addition to RF input signals, baseband I/Q input signals can be measured using the Option B7C “Baseband I/Q Inputs”.

When a modulation accuracy measurement is performed, the following data is provided (See [Figure 4-45 on page 481](#)):

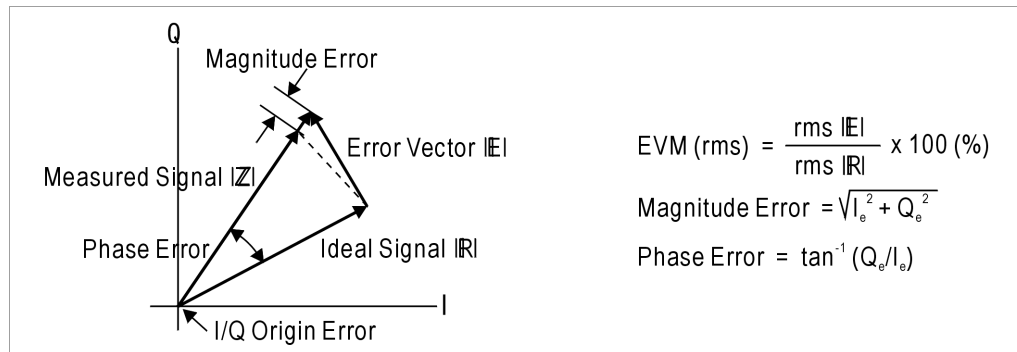
- Rho - modulation quality representing the ratio of the correlated power in a multi coded channel to the total signal power
- EVM - peak and rms error vector magnitude
- Peak CDE at C8 SF256 for BTS test or at C2 SF4 for MS test - peak code domain error at the code number, with respect to the ideal total power
- Peak Active CDE - peak active code domain error with a code number
- Magnitude Error - rms magnitude error
- Phase Error - rms phase error
- Freq Error - the frequency difference between the transmitter’s actual center frequency and the frequency (or channel) that you entered
- I/Q Origin Offset - the origin offset for I/Q signals,

- Time Offset - the time offset between the external frame trigger and CPICH

If both the primary antenna CPICH C9(0) and STTD (Space Time Transmit Diversity) antenna CPICH C9(1) are detected, then the measured value “Time Offset” will change to “Diversity Timing Err” to show the time difference between these two channels (CPICH C9(0) and CPICH C9(1)).

- Active Channels - the number of active channels in the input signal

Figure 4-45 Error Vector Magnitude and Related Parameters



Active Channel Detection

NOTE

Symbol Boundary selections are only available if **Mode Setup, Radio** is set to DL.

Active channel detection selections are available to allow you to determine how the instrument detects W-CDMA active channels. There are three choices available under the **Meas Setup, Symbol Boundary** menu:

- **Auto** - Use this setting to detect active channels automatically based on the entire **Capture Intvl** (Interval) setting.
- **Predefined Test Models** - Test Models 1 through 5 may be selected to assure correct active channel detection if you are using these models.

Concepts

Multi Carrier Power Measurement Concepts

Purpose

This measurement is for adjusting multi carrier power amplifiers to transmit well balanced multiple carriers. In this measurement, two carrier inputs are required to make measurements of the in-channels and out-of-channels powers. Four carrier inputs can be measured, even if the reference channel selection is limited to two out of four carriers. If a power amplifier accepts multiple carriers, the intermodulation products caused by these carriers will act to decrease the performance of the amplifier.

Measurement Method

This measurement method is very similar to a combination of the ACPR measurement (specifically, making measurements with the measuring mode of **All Channels**) and the intermodulation products measurement (specifically, making measurements with the measuring mode of **3rd IM Only** or **3rd/5,7th IM**).

If there are two carriers, the second carrier frequency needs to be offset by a multiple of 5 MHz from the center carrier frequency. This multiplier ranges from ± 1 to ± 3 , resulting in the offset frequencies of -15 MHz, -10 MHz, -5 MHz, +5 MHz, +10 MHz, and +15 MHz.

If **Meas Mode** is set to **All Channels**, the center and second carrier levels along with the power levels in the lower and upper offset channels are listed in the text window. The lower offset channels are referenced to the lower frequency carrier channel, and the upper offset channels are referenced to the upper frequency carrier channel. Depending on the selection of the second carrier offsets, one or two -5 MHz offset channels can be displayed between the center and second carrier channels.

If **2nd Carrier Offset** is set to either -15 MHz or +15 MHz, the power levels at -5, 5, 10, and 15 MHz offset channels from the lower and upper frequency carrier channels are measured in that order. The -5 MHz offset channel from the lower frequency carrier is displayed immediately to the right of the lower frequency carrier channel. The -5 MHz offset channel from the upper frequency carrier is displayed immediately to the left of the upper frequency carrier channel.

If **2nd Carrier Offset** is set to either -10 MHz or +10 MHz, the power levels at -5 MHz offset channels from the lower frequency carrier and 5 and 10 MHz offset channels from the lower and upper frequency carrier channels are measured.

If **2nd Carrier Offset** is set to either -5 MHz or $+5$ MHz, the power levels at 5 and 10 MHz offset channels from the lower and upper frequency carrier channels are measured.

If **Meas Mode** is set to **3rd IM Only** or **3rd/5,7th IM**, the intermodulation product levels caused by two carriers are measured in the offset channels corresponding to the selection of the second carrier offset.

For getting the relative measurement results in addition to the absolute power levels, the reference channel power can be set to either the center carrier, second carrier, average of two carriers, or automatic selection. This automatic selection is to identify the highest power level in two carrier powers as the reference channel power. Auto (Lower) is shown if the lower frequency carrier power is equal to or larger than that of the upper frequency carrier. Auto (Upper) is shown if the upper frequency carrier power is larger than that of the lower frequency carrier.

Occupied Bandwidth Measurement Concepts

Purpose

Occupied bandwidth measures the bandwidth containing 99.0 of the total transmission power.

The spectrum shape of a W-CDMA (3GPP) signal can give useful qualitative insight into transmitter operation. Any distortion to the spectrum shape can indicate problems in transmitter performance.

Measurement Method

The instrument uses digital signal processing (DSP) to sample the input signal and convert it to the frequency domain. With the instrument tuned to a fixed center frequency, samples are digitized at a high rate with DSP hardware, and then converted to the frequency domain with FFT software.

The total absolute power within the measurement frequency span is integrated for its 100% of power. The lower and upper frequencies containing 0.5% each of the total power are then calculated to get 99.0% bandwidth.

For E4406A, Option B7C, in addition to RF input signals, baseband I/Q signals can be measured using the Option B7C “Baseband I/Q Inputs”.

Power Control Measurement Concepts

Purpose

Power control capability is one of the major functions of a W-CDMA (3GPP) digital radio system. For downlink signals, code domain power analysis and power versus time measurements based on symbols may be used to analyze the power control function, as individual code channel powers are controlled. However, for an uplink signal, the entire signal is controlled by the power control function, so code domain power analysis or power versus time measurement techniques will not provide relevant information. This Power Control measurement provides a solution for users to make 3GPP uplink conformance tests, and can be used to accurately design, characterize, evaluate, and verify 3GPP transmitters, components, or devices for mobile stations.

Power control limits the transmitted power level resulting in minimized interference levels and greater system capacity. In the UL, the objective is to optimize the power that each UE transmits to ensure proper communication. An excess error of the power control decreases the system capacity. There are three different power control loops in the UL: outer loop power control, open loop power control, and inner loop power control. Outer loop power control is used by the network to set a signal quality level based on the desired Quality of Service (QoS) [20]. Open loop power control is used only during initial access of the UE to the network or when UL transmission needs to be interrupted; such as, during a hard handoff. The power used for PRACH transmission is adjusted by the UE based on the power measured by the UE on the received signal and the signaled BCCH information from the BTS. The UE open loop power control tolerance must not exceed the values described in the specifications. [Figure 2-34 on page 112](#) shows a display of an open loop power control measurement on the PRACH.

Inner loop power control (also called fast closed loop power control) operates rapidly in real time to maintain the desired signal quality level. Inner loop power control in the UL is used during regular UE transmission. In order to minimize interference, the UE transmitter adjusts its output power in accordance with TPC commands received in the DL. Power control commands are sent at every slot. The UE transmitter must be capable of changing the output power with a step size of 1 dB, 2 dB, or 3 dB (the latter is only used in compressed mode), in the slot immediately after the received TPC command can be derived. The UE inner loop power control size and response must meet the values described in the specifications (see 5.4.2 Inner loop power control in the uplink in [12]). This test also verifies that the UE derives the received TPC commands correctly.

For E4406A, Option B7C, in addition to RF input signals, baseband I/Q input signals can be measured using the Option B7C “Baseband I/Q Inputs”.

PRACH Measurements

PRACH (Physical Random Access Channel) transmits signaling information from UE to BTS. It consists of two parts, a Preamble and Message. Preambles are repeated until BTS responds by AICH as burst of 1.067ms (4096chips) length. Each preamble has 3 access slots' interval. (1 access slot = 1.333ms) 15 access slots every two frames. Preamble signature takes 16 types from 0 to 15. PRACH Message should be transmitted after AICH receiving.

The Uplink PRACH is used to make initial contact with a base station and then to convey signaling messages to the network when the mobile is not on a DPDCH/DPCCH. A PRACH is composed of two distinct parts: a number of preambles and a message portion. The PRACH preambles are 1.067 ms bursts (4096 chips) of a complex signature consisting of 16 symbols that are scrambled with a cell specific, 4096 chip long segment of a 225 Complex Gold Code generator. There are 16 available complex signatures. Adjacent cells must use different scrambling codes to eliminate confusion as to which cell the mobile station is trying to contact. More than one scrambling code may be used by a cell if loading demands it. The preambles are transmitted in predefined access slot of 1.333 ms duration. This means that there are 15 access slots every two frames ($15 * 1.33 = 20$ ms). The preambles are repeated until the base station acknowledges receiving the preamble on the AICH. Once the mobile receives a reception indication on the AICH, it transmits the message portion of the PRACH. The message portion is 10 ms in length and uses a modulation scheme that is very similar to that of the combined DPDCH/DPCCH. The Physical Common Packet Channel (PCPCH) used a very similar scheme with the exception that a collision resolution preamble is sent once the base station responds on the AICH. A 10 ms power control preamble is then sent followed by the message packet.

Measurement Method

The Power Control measurement is also called the Power Step measurement. The Power Control measurement includes three types of measurements:

- Slot Power- the Slot Power measurement measures uplink slot power level.
- PRACH Power - the PRACH Power measurement measures uplink PRACH preamble power level.
- Slot Phase- The Slot Phase measurement measures phase error, frequency error and EVM of uplink slots in addition to their slot power.

The Slot Power and PRACH Power Measurement can be done using two methods:

- Waveform Method- the Waveform Method is asynchronous. It provides results using a specified resolution bandwidth and a specified filter type for the number of frames, 1 through 8, specified by the capture interval.
- Chip Power Method - the Chip Power Method is synchronized to chip timing. It re-samples the power measurement results based on the chip clock timing of the radio system.

The Slot Phase Measurement is always made based on synchronized chip timing.

NOTE

The current Power Control Measurement can measure only the uplink signals. The measurement is not yet capable of downlink power control measurement. Therefore, the measurement softkey "Pwr Control" is active only if the Radio Device selection is MS. The softkey is grayed out if BTS is chosen.

Power Stat CCDF Measurement Concepts

Purpose

Many of the digitally modulated signals now look noise-like in the time and frequency domain. This means that statistical measurements of the signals can be a useful characterization. Power Complementary Cumulative Distribution Function (CCDF) curves characterize the higher level power statistics of a digitally modulated signal. The curves can be useful in determining design parameters for digital communications systems.

In mobile communications, battery life is one of the most important characteristics of the handset. The efficiency of the power amplifier is key to maximizing battery life. W-CDMA uses a non-constant amplitude scheme, forcing the use of more expensive, less efficient, linear amplifiers. For W-CDMA, the Peak to Average Ratio (PAR) of the signal is a concern. The PAR is defined as the ratio of the peak envelope power to the average envelope power of a signal. A signal with a high PAR requires more headroom in the amplifier, which makes it less efficient. 2G non-constant amplitude formats, such as p/4 DQPSK (differential quadrature phase shift keying, used in PDC), minimize the PAR by avoiding signal envelope transitions through zero. In W-CDMA the UE can transmit multiple channels to accommodate the high data rates. QPSK is used in combination with a spreading/scrambling function (HPSK) to minimize the PAR [8]. With this technique, the PAR for the basic configuration (one DPDCH and one DPCCH) is equal or larger than 3.6 dB during 0.1 percent of the time.

However, even though HPSK reduces the PAR, the PAR still increases as code channels are activated. The worst case scenario would be when five or six channels are required (see code domain power section). Although, it is expected that this will only happen a small percentage of the time, it is still critical.

The power statistics CCDF measurement can be affected by many factors. For example, modulation filtering, modulation format, combining the multiple signals at different frequencies, number of active codes, and correlation between symbols on different codes with spread spectrum systems will all affect measurement results. These factors are all related to modulation and signal parameters. External factors such as signal compression and expansion by nonlinear components, group delay distortion from filtering, and power control within the observation interval also affect the measurement.

Both the amplifier designer and the system integrator must make sure that the PA (and other components) can handle the PAR that the signal exhibits for the different data rates, while maintaining a good ACL performance. You can use the complementary cumulative distribution function to help you with this job.

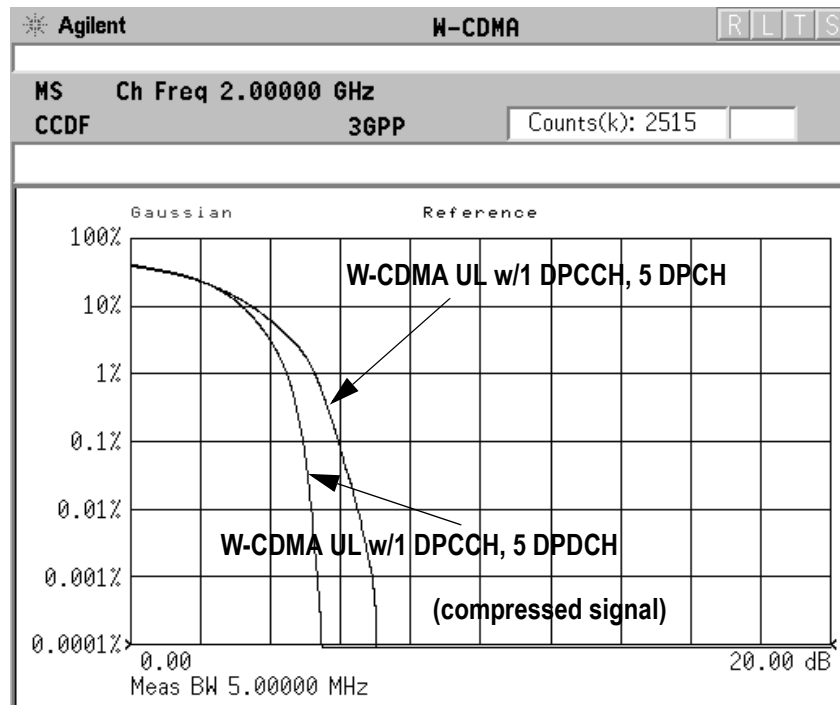
The complementary cumulative distribution function (CCDF) fully characterizes the power statistics of a signal [15]. It provides PAR versus probability. Figure 4-46 on page 489 shows the CCDF curves for two UL W-CDMA signals with different channel configurations. For a probability of 0.1 percent, the PAR of the signal with one DPCCH and five DPDCH is 2.85 dB higher than that of the signal with one DPCCH and one DPDCH.

CCDF curves can help you in several situations:

- To determine the headroom required when designing a component [15].
- To confirm the power statistics of a given signal or stimulus. CCDF curves allow you to verify if the stimulus signal provided by another design team is adequate. For example, RF designers can use CCDF curves to verify that the signal provided by the digital signal processing (DSP) section is realistic.
- To confirm that a component design is adequate or to troubleshoot your subsystem or system design, you can make CCDF measurements at several points of a system. For example, if the ACLR of a transmitter is too high, you can make CCDF measurements at the input and output of the PA. If the PA design is correct, the curves will coincide. If the PA compresses the signal, the PAR of the signal is lower at the output of the PA (Figure 4-46 on page 489).

Concepts

Figure 4-46 CCDFs for a W-CDMA Signal, with and without Compression



Measurement Method

The power measured in power statistics CCDF curves is actually instantaneous envelope power defined by the equation:

$$P = (I^2 + Q^2)/Z_0$$

(where I and Q are the quadrature voltage components of the waveform and Z_0 is the characteristic impedance).

A CCDF curve is defined by how much time the waveform spends at or above a given power level. The percent of time the signal spends at or above the level defines the probability for that particular power level. For capturing a lower probability down to 0.0001%, this measurement is made in the single mode by setting **Measure** under **Meas Control** to **Single**. To make the power statistics CCDF measurement, the instrument uses digital signal processing (DSP) to sample the input signal in the channel bandwidth.

The Gaussian distribution line as the band-limited Gaussian noise CCDF reference line, the user-definable reference trace, and the currently measured trace can be displayed on a semi-log graph. If the currently measured trace is above the user reference trace, it means that the higher peak power levels against the average power are included in the input signal.

For E4406A, Option B7C, in addition to RF input signals, baseband I/Q input signals can be measured using the Option B7C “Baseband I/Q Inputs”.

Power versus Time Mask Measurement Concepts

Purpose

A W-CDMA (3GPP) cellular system utilizes a variable rate voice coder in order to provide the maximum system capacity. According to the activity in the voice channel, the codec varies the data rate. If the voice codec drops below the full rate, 9600 bps for instance, a W-CDMA (3GPP) mobile bursts its output power on and off proportionally to the data rate reduction. At a half rate, a mobile transmits 50% of the time, and at one eighth rate, it transmits 12.5% of the time. To prevent the interference caused by bursting the RF carrier, the associated standard specifies a power versus time template to which a mobile must conform.

This template defines the burst length, the rising and falling edges, the masks for regions of power on and power off.

Measurement Method

The 3GPP Specifications do not detail a standard test procedure for PvT measurements. A PvT measurement requires a burst signal to be supplied periodically. Under normal operating conditions, this is not a typical transmission pattern, and you must configure the UE to produce this type of signal to perform a PvT measurement. Further details are offered in the following section. Once supplied, a single burst is captured as a time domain data acquisition, with a single trigger. The rising and falling edges are detected at the crossing points with the burst search threshold level. The burst center point in time is determined, and then the required masks are aligned in time with the center point. To make a precise slope detection, its threshold level and detection interval techniques are incorporated to extract only steep enough slopes out from the noise-like signals.

For MS conformance testing, the PvT Mask measurement uses the PRACH signal as a burst signal. If an actual burst signal is available it should be used. The 3GPP standards does not define a W-CDMA PvT method, but the method used for this measurement is very similar to that defined for cdma2000. If the DPCH (CPCCH/DPDCH) uplink signal can be configured to a burst signal this measurement may be used. The default parameters are set to measure a two-slot on, two-slot off burst signal.

QPSK EVM Measurement Concepts

Purpose

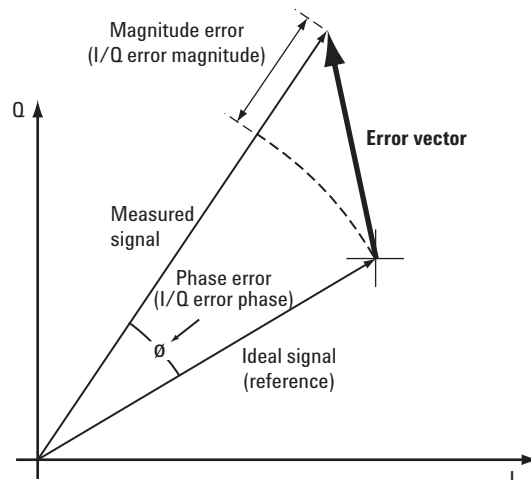
In constant amplitude modulation schemes, such as GMSK, the phase and frequency error are the metrics for modulation quality. However, these metrics are not very effective for non-constant amplitude modulation formats that can also have errors in amplitude.

Phase and frequency errors are measures of modulation quality for the W-CDMA (3GPP) system. This modulation quality is quantified through QPSK Error Vector Magnitude (EVM) measurements. Since the base stations in W-CDMA (3GPP) systems use Quadrature Phase Shift Keying (QPSK) modulation, the phase and frequency accuracies of the transmitter are critical to the communications system performance and ultimately affect range.

W-CDMA (3GPP) receivers rely on the phase and frequency quality of the QPSK modulation signal in order to achieve the expected carrier to noise ratio. A transmitter with high phase and frequency errors will often still be able to support phone calls during a functional test. However, it will tend to cause difficulty for mobiles trying to maintain service at the edge of the cell with low signal levels or under difficult fading and Doppler conditions.

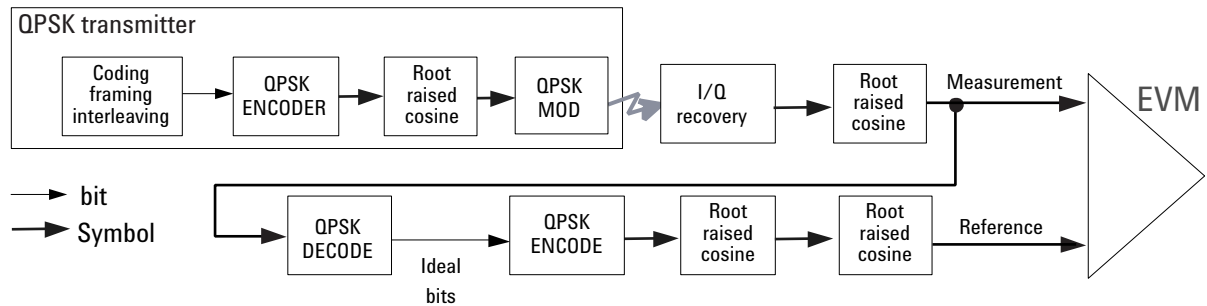
The accuracy of non-constant amplitude modulation schemes, such as quadrature amplitude modulation (QAM), or quadrature phase shift keying (QPSK), can be assessed very effectively by looking at the constellation of the signal. Signal impairment can be objectively assessed by taking the displacement of each measured symbol from the reference position as an error phasor (or vector), as shown in [Figure 4-47 on page 492](#).

Figure 4-47 Error Vector and Related Parameters



The reference position is determined from a reference signal that is synthesized by demodulating the data bits from the received signal and then re-modulating these bits "perfectly" for a generic QPSK signal, as shown in Figure 4-48.

Figure 4-48 Process to Calculate EVM for a Generic QPSK Signal



The root mean square (RMS) of the error vectors is computed and expressed as a percentage of the square root of the mean power of the ideal signal¹. This is the error vector magnitude (EVM). EVM is a common modulation quality metric widely used in digital communication systems. (See [16] for more information on how to use EVM as a troubleshooting tool.)

When we consider evaluating the modulation accuracy of W-CDMA it becomes evident that this explanation of EVM, while sufficient for ordinary QPSK or QAM, needs further elaboration. Should we measure the EVM at the chip level or at the symbol level? Should we measure EVM for a signal with a single DPDCH channel or with another channel configuration? How do we calculate the reference?

1. The actual calculation method of the percentage depends on the specific standard. The EVM may be normalized to the amplitude of the outermost symbol, the square root of the average symbol power, or the square root of the mean power of the ideal signal. In the case of W-CDMA, the specifications require normalization to the square root of the mean power of the ideal signal (see section on Composite EVM).

For a regular QAM or a Phase Shift Keyed (PSK) signal, the ideal symbol points always map onto a few specific locations in the I/Q plane. However, the W-CDMA UL and DL signals are different. The UL signal can consist of multiple channels that are I/Q multiplexed. This means the bits for each channel are binary phase shift keying (BPSK) encoded¹ for either the I or the Q paths. Several channels can be added to the I and/or the Q paths. The resulting I and Q signals are then spread and scrambled with a special function (HPSK, see [Figure 4-11 on page 413](#)). A W-CDMA DL signal also consists of several code channels. Each channel is QPSK encoded², and the I and Q signals are spread and complex scrambled (see [Figure 4-10 on page 411](#)). The code channels are typically added at this point, before the baseband filtering. The final DL constellation at the RF does not typically look like QPSK, or any other known constellation, except for some very specific channel configurations. For example, a signal with a single code channel does map onto a 45°-rotated QPSK constellation. The rotation is caused by the complex scrambling. Since the receiver does not care about the absolute phase rotation, it effectively sees a QPSK constellation.

The complex-valued chip sequence is then filtered with an RRC filter ($\alpha = 0.22$) and the result is applied to the QPSK³ modulator. The UE transmitter in [Figure 4-49 on page 495](#) illustrates this process, and the BS transmitter is shown in [Figure 4-50 on page 495](#).

The resulting constellation depends on the physical channel configuration. The constellation typically does not look like QPSK, or any other known constellation, except for some very specific channel configurations. For example, signal with a single DPDCH (or a single DPCH) at the same amplitude level maps onto a 45°-rotated QPSK constellation, as shown in [Figure 4-51 on page 496](#). Because the receiver does not care about the absolute phase rotation, it effectively sees a QPSK constellation.

1. BPSK encoding, in this case, refers to the process of mapping the bits for a channel onto the I (or the Q) path in serial. This means that the bits for a channel are directly converted into I (or Q) amplitude levels. For example, 1001 would be converted to 1 -1 -1 1.
2. QPSK encoding, in this case, refers to the process of mapping the bits for a channel onto the I (or the Q) path in parallel.
3. QPSK modulation, in this case, refers to the up conversion process of modulating the RF carrier with the I/Q baseband signal.

You can use a regular QPSK EVM measurement to evaluate the modulation quality of the transmitter for a single DPDCH, a single DPDCH, or a signal with both at the same amplitude level. More complex signals cannot be analyzed with this measurement. QPSK EVM compares the measured chip signal at the RF with an ideal QPSK reference (see Figure 4-49).

Figure 4-49 Process to Calculate QPSK EVM for a W-CDMA UL Signal

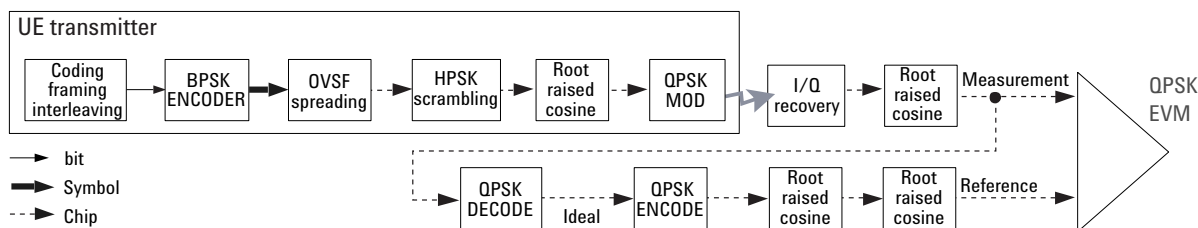
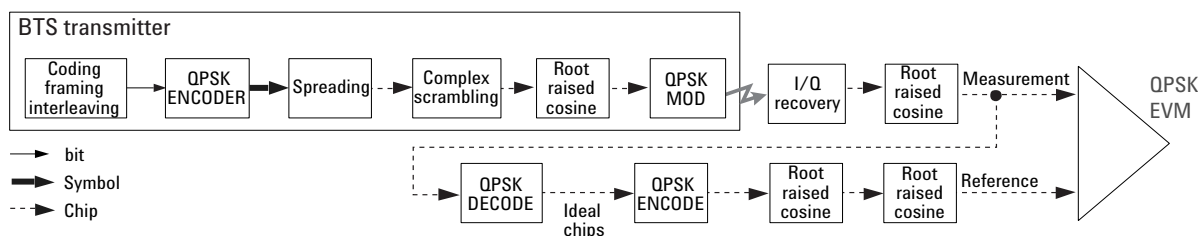


Figure 4-50 Process to Calculate QPSK EVM for a W-CDMA DL Signal



The QPSK EVM measurement does not descramble and despread the signal into symbols and back into chips to calculate the appropriate reference. Therefore, it can detect baseband filtering, modulation, and RF impairments, but does not detect OVSF spreading or HSPK scrambling errors.

If it is impossible to despread and descramble the signal, the QPSK EVM measurement may be the only choice. In this sense, the QPSK EVM measurement can be useful to RF designers or system integrators to evaluate the modulation quality of the analog section of the transmitter when the spreading or scrambling algorithms are not available or do not work properly. For example, Figure 4-51 shows the QPSK EVM measurement and vector diagram for a W-CDMA UL signal (one DPDCH and a DPCCH at the same power level) without an I/Q quadrature error, while Figure 4-52 shows the QPSK EVM measurement and vector diagram for a W-CDMA UL signal (one DPDCH and a DPCCH at the same power level) with an I/Q quadrature error caused by constellation distortion.

Concepts

Depending on the nature of the error, you can use the vector diagram, the error vector versus time or frequency, the magnitude error versus time, or the phase error versus time to troubleshoot it. For example, most I/Q impairments, such as the I/Q quadrature error in [Figure 4-52](#), can be easily recognized by looking at the vector diagram. In that example, the quadrature axes are not orthogonal. In-channel spurious signals can be detected by analyzing the error vector spectrum [16].

Figure 4-51 QPSK EVM Measurement of W-CDMA UL (without Impairment)

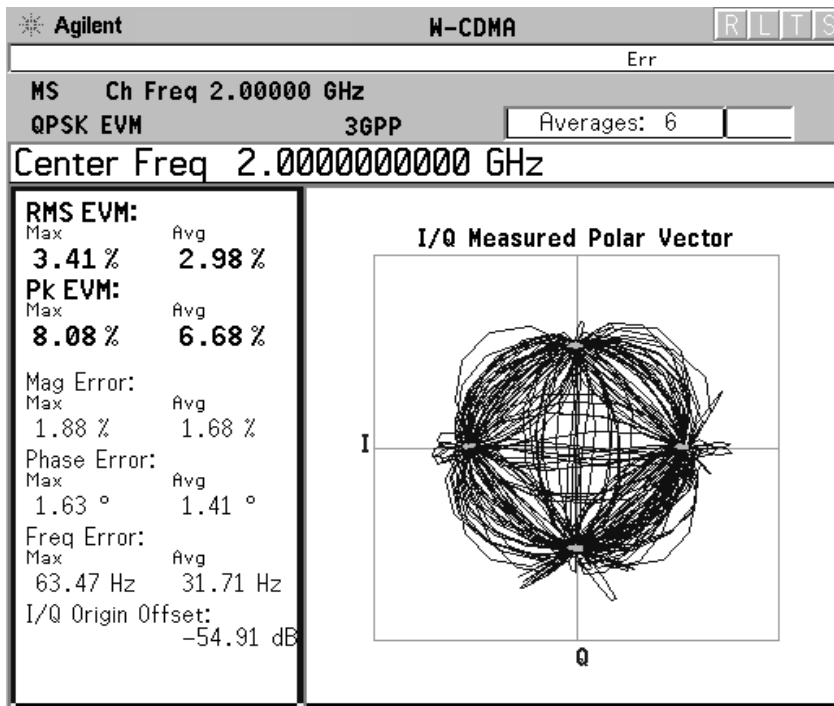
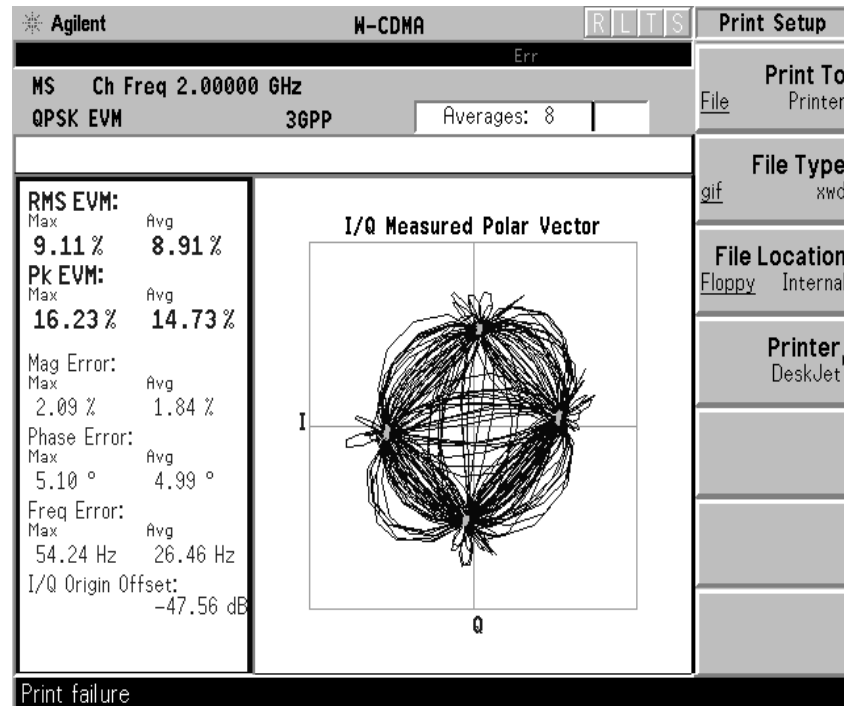


Figure 4-52

QPSK EVM Measurement of W-CDMA UL (with Quadrature Error Causing Constellation Distortion)



Measurement Method

The signal to be measured needs to be a single coded signal such as one DPCH, a single DPDCH, or a DPDCH and a DPCCH. The phase error of the unit under test is measured by computing the difference between the phase of the transmitted signal and the phase of a theoretically perfect signal.

The instrument samples the transmitter output in order to capture the actual phase trajectory. This is then demodulated and the ideal phase trajectory is mathematically derived using detected bits and root-raised cosine channel filtering. Subtracting one from the other results in a phase error signal.

This measurement allows you to display these errors numerically and graphically on the instrument display. There are graphs for I/Q Measured Polar Vector, I/Q Measured Polar Constellation, EVM, Phase Error and Mag Error in the graph windows. In the text window, there are both maximum and average data for Evm: in % rms, in % peak, RMS Mag Error: in %, Phase Error: in degrees, Freq Error: in Hz, and IQ Origin Offset: in dB.

For E4406A, Option B7C, in addition to RF input signals, baseband I/Q input signals can be measured using the Option B7C "Baseband I/Q Inputs".

Spectrum Emission Mask Measurement Concepts

Purpose

The Spectrum Emission Mask measurement includes the in-band and out-of-band spurious emissions. As it applies to W-CDMA (3GPP), this is the power contained in a specified frequency bandwidth at certain offsets relative to the total carrier power. It may also be expressed as a ratio of power spectral densities between the carrier and the specified offset frequency band.

This spectrum emission mask measurement is a composite measurement of out-of-channel emissions, combining both in-band and out-of-band specifications. It provides useful figures-of-merit for the spectral regrowth and emissions produced by components and circuit blocks, without the rigor of performing a full spectrum emissions mask measurement.

Measurement Method

The spectrum emission mask measurement measures spurious signal levels in up to five pairs of offset/region frequencies and relates them to the carrier power. The reference channel integration bandwidth method is used to measure the carrier channel power and offset/region powers. When **Offset** is selected, spectrum emission mask measurements are made, relative to the carrier channel frequency bandwidth. When **Region** is selected, spurious emission absolute measurements are made, set by specifying start and stop RF frequencies. The upper frequency range limit is 3.678 GHz.

This integration bandwidth method is used to perform a data acquisition. In this process, the reference channel integration bandwidth (Meas BW) is analyzed using the automatically defined resolution bandwidth (Res BW), which is much narrower than the channel bandwidth. The measurement computes an average power of the channel or offset/region over a specified number of data acquisitions, automatically compensating for resolution bandwidth and noise bandwidth.

This measurement requires the user to specify the measurement bandwidths of carrier channel and each of the offset/region frequency pairs up to 5. Each pair may be defined with unique measurement bandwidths. The results are displayed both as relative power in dBc, and as absolute power in dBm. Refer to [Table 3-20 on page 322](#) for the default values of offset and region frequencies, resolution bandwidths, and limits.

Spectrum (Frequency Domain) Measurement Concepts

Purpose

The spectrum measurement provides spectrum analysis capability for the instrument. The control of the measurement was designed to be familiar to those who are accustomed to using swept spectrum analyzers.

This measurement is FFT (Fast Fourier Transform) based. The FFT-specific parameters are located in the **Advanced** menu. Also available under basic mode spectrum measurements is an I/Q window, which shows the I and Q signal waveforms in parameters of voltage versus time. The advantage of having an I/Q view available while in the spectrum measurement is that it allows you to view complex components of the same signal without changing settings or measurements.

Measurement Method

The measurement uses digital signal processing to sample the input signal and convert it to the frequency domain. With the instrument tuned to a fixed center frequency, samples are digitized at a high rate, converted to I and Q components with DSP hardware, and then converted to the frequency domain with FFT software.

For E4406A Option B7C, this measurement is available for both the RF input and baseband I/Q inputs. For details on Baseband I/Q operation see the section on “Using Option B7C Baseband I/Q Inputs”.

Troubleshooting Hints

Changes made by the user to advanced spectrum settings, particularly to ADC range settings, can inadvertently result in spectrum measurements that are invalid and cause error messages to appear. Care needs to be taken when using advanced features.

Waveform (Time Domain) Measurement Concepts

Purpose

The waveform measurement is a generic measurement for viewing the input signal waveforms in the time domain. This measurement is how the instrument performs the zero span functionality found in traditional spectrum analyzers.

Basic mode waveform measurement data may be displayed using either a Signal Envelope window, or an I/Q window which shows the I and Q signal waveforms in parameters of voltage versus time. The advantage of having an I/Q view available while making a waveform measurement is that it allows you to view complex components of the same signal without changing settings or measurements.

For E4406A, an I/Q Polar display is also available to view the I and Q waveforms in a polar plot. This display shows the instantaneous relationship between the I and Q waveform voltages.

The waveform measurement can be used to perform general purpose power measurements in the time domain with excellent accuracy.

Measurement Method

The instrument makes repeated power measurements at a set frequency, similar to the way a swept-tuned spectrum analyzer makes zero span measurements. The input analog signal is converted to a digital signal, which then is processed into a representation of a waveform measurement. The measurement relies on a high rate of sampling to create an accurate representation of a time domain signal.

For E4406A with Option B7C, this measurement is available for use with both the RF input and baseband I/Q inputs. For details on Baseband I/Q operation see the section on “Using Option B7C Baseband I/Q Inputs”.

Baseband I/Q Inputs (Option B7C) Measurement Concepts

The E4406A VSA Option B7C Baseband I/Q Inputs provides the ability to analyze baseband I/Q signal characteristics of mobile and base station transmitters. This option may be used only in conjunction with the following personalities:

- Basic mode (available in all VSA Series Transmitter Testers)
- Option BAF W-CDMA Measurement Personality
- Option B78 cdma2000 Measurement Personality
- Option 202 GSM with EDGE
- Option 252 GSM to GSM with EDGE upgrade

What are Baseband I/Q Inputs?

Option B7C consists of a Baseband Input module, four 50 Ω BNC connectors, and internal cabling. The four BNC connectors are grouped into pairs at the upper left corner of the front panel. The upper two connectors labeled “I” and “Q” are the “unbalanced” inputs.

In practice, an unbalanced or “single-ended” baseband measurement of an I or Q signal is made using a probe connected to the I or Q connector. A simultaneous I/Q unbalanced single-ended measurement may be made using two probes connected to the I and Q input connectors.

If “balanced” signals are available, they may be used to make a more accurate measurement. Balanced signals are signals present in two separate conductors, are symmetrical about ground, and are opposite in polarity, or out of phase by 180 degrees.

Measurements using balanced signals can have a higher signal to noise ratio resulting in improving accuracy. Noise coupled into each conductor equally in a “common mode” to both signals may be separated from the signal. The measure of this separation is “common-mode rejection”.

To make a balanced measurement, the lower two connectors labeled “I” and “Q” are used in conjunction with the I and Q inputs. The terms “I-bar” and “Q-bar” may be applied to the signals, as well as the inputs themselves. Probes (customer provided) must be used to input balanced baseband I/Q signals. This may be referred to as a balanced measurement.

Balanced baseband measurements are made using the I and I connectors for I only signal measurements, while the Q and Q connectors are used for a Q only signal measurement. Balanced measurements of I/Q require differential probe connections to all four input connectors. For details of probe selection and use, refer to

“Selecting Input Probes for Baseband Measurements” on page 503.

What are Baseband I/Q Signals?

In transmitters, the term baseband I/Q refers to signals that are the fundamental products of individual I/Q modulators, before the I and Q component signals are combined, and before upconversion to IF or RF frequencies.

In receivers, baseband I/Q analysis may be used to test the I and Q products of I/Q demodulators, after an RF signal has been downconverted and demodulated.

Why Make Measurements at Baseband?

Baseband I/Q measurements are a valuable means of making qualitative analyses of the following operating characteristics:

- I/Q signal layer access for performing format-specific demodulation measurements (e.g. CDMA, GSM, W-CDMA):
- Modulation accuracy – i.e. I/Q plane metrics
 - rho
 - error vector magnitude; rms, peak, or 95%
 - carrier feed-through
 - frequency error
 - magnitude and phase errors
- Code-domain analysis (including code-specific metrics)
- CCDF of $I^2 + Q^2$
- Single sideband (SSB) metrics for assessing output quality
- Basic analysis of I and Q signals in isolation including: DC content, rms and peak to peak levels, CCDF of each channel

Comparisons of measurements made at baseband and RF frequencies produced by the same device are especially revealing. Once signal integrity is verified at baseband, impairments can be traced to specific stages of upconversion, amplification, or filtering by RF analysis. Likewise, impairments to signal quality that are apparent at RF frequencies may be traceable to baseband using baseband analysis.

Selecting Input Probes for Baseband Measurements

The selection of baseband measurement probe(s) and measurement method is primarily dependent on the location of the measurement point in the circuit. The probe must sample voltages without imposing an inappropriate load on the circuit.

The following measurement methods may be used with baseband I/Q inputs:

- **50 Ω Unbalanced** - This is the measurement method of choice if single-ended or unbalanced baseband I and/or Q signals are available in 50 Ω coaxial transmission lines and are terminated in a coaxial connectors. Adapters necessary to convert to a 50 Ω BNC-type male connector must be of 50 Ω impedance.

The methods are as follows:

- I only measurement using one single-ended probe connected to the I input connector (available in the Basic mode)
- Q only measurement using one single-ended probe connected to the Q input connector (available in the Basic mode)
- I/Q measurement using two single-ended probes connected to the I and Q input connectors

- **600 Ω Balanced** - This is the measurement method of choice if balanced baseband signals having a 600 Ω impedance are available. The methods are as follows:

- I only measurement using one differential probe or two single-ended probes connected to the I and I inputs (available in the Basic mode)
- Q only measurement using one differential probe or two single-ended probes connected to the Q and Q inputs (available in the Basic mode)
- I/Q measurement using two differential probes or four single-ended probes connected to the I, Q, I, and Q input connectors

- **1 M Ω Unbalanced** - High input impedance is the measurement method of choice if single-ended or unbalanced baseband signals to be measured lie in a trace on a circuit board and are sensitive to loading by the probe. This is the default input connector setting.

When making 1 M Ω measurements, the reference input impedance may be adjusted. For details refer to [“I/Q Input Z Key Menu” on page 389](#). 1 M Ω unbalanced measurements may be made as follows:

- I only measurement using one single-ended probe connected to the I input connector (available in the Basic mode)
 - Q only measurement using one single-ended probe connected to the Q input connector (available in the Basic mode)
 - I/Q measurement using two single-ended probes connected to the I and Q input connectors
- **1 M Ω Balanced** - High input impedance measurements may also be made if differential or balanced signals are available. 1 M Ω balanced measurements may be made as follows:
 - I only measurement using one differential probe or two single-ended probes connected to the I and I inputs (available in the Basic mode)
 - Q only measurement using one differential probe or two single-ended probes connected to the Q and Q inputs (available in the Basic mode)
 - I/Q measurement using two differential probes or four single-ended probes connected to the I, Q, I, and Q input connectors

This is the measurement method of choice if differential or balanced baseband signals to be measured lie in a trace on a circuit board and are sensitive to loading by the probe. When making 1 M Ω measurements, the reference input impedance may be adjusted. For details refer to [“I/Q Input Z Key Menu” on page 389](#).

The following table lists the probes currently available from Agilent, which are suitable for use under various measurement conditions:

Table 4-17

Agilent Probes - Balanced and Unbalanced

Probe Type	Description
Unbalanced (single-ended)	1144A 800 MHz Active Probe ^{abc} 54701A 2.5 GHz Active Probe ^{bed} 1145A 750 MHz 2-Channel Active Probe ^{abc} 85024A High Frequency Probe ^{be} 41800A Active Probe ^{bf} 10020A Resistive Divider Probe ^{bc} 54006A 6 GHz Passive Divider Probe ^g
Balanced (differential)	1141A 200 MHz Active Differential Probe ^{abc} N1025A 1 GHz Active Differential Probe ^{bh}

- a. Not compatible with 3-wire power interface. Needs 1142A power supply. For two channels, you will need either two 1142A power supplies or one 1142A power supply and one 01144-61604 1-input, two-output adapter cable.
- b. Two probes needed to cover both I and Q inputs.
- c. Output connector is BNC-type.
- d. Not compatible with 3-wire power interface. Requires use of 1143A power supply that can power two 54701A probes.
- e. 85024A bandwidth is 300 kHz to 3 GHz. Output connector is N-type. Power is 3-wire connector (+15 V, -12.6 V, ground).
- f. 41800A bandwidth is 5 Hz to 500 MHz. Output connector is N-type. Power is 3-wire connector (+15 V, -12.6 V, ground).
- g. 54006A output connector is 3.5 mm
- h. 3.5 mm output connector, requires ± 15 V supply.

Refer to the current Agilent data sheet for each probe for specific information regarding frequency of operation and power supply requirements.

The E4406A Transmitter Tester provides one “three-wire” probe power connector on the front panel. Typically, it can energize one probe. If you plan on operating more than one probe, make sure you provide sufficient external power sources as required.

Baseband I/Q Measurement Views

Measurement result views made in the Basic mode, or by other compatible optional personalities, are available for baseband signals if they relate to the nature of the signal itself. Many measurements which relate to the characteristics baseband I and Q signals have when mixed and upconverted to signals in the RF spectrum can be made as well. However, measurements which relate to the characteristics of an upconverted signal that lie beyond the bandwidth available to the Baseband I/Q Input circuits can not be measured (the limits are up to 5 MHz bandwidth for individual I and Q signals, and up to 10 MHz for composite I/Q signals).

Some measurement views are appropriate for use with both RF and baseband I/Q signals without any modification, while other views must be altered. Some examples of measurements with identical results views are QPSK EVM, Code Domain, and CCDF. For Spectrum measurements, identical views include the I and Q Waveform view and the I/Q Polar view. For Waveform measurements, identical views include the I/Q Waveform view, the Signal Envelope view, and the I/Q Polar view.

At RF frequencies, power measurements are conventionally displayed on a logarithmic vertical scale in dBm units, whereas measurements of baseband signals using Baseband I/Q inputs may be conveniently displayed as voltage using a linear vertical scale as well as a log scale.

Spectrum Views and 0 Hz Center Frequency

Some views must be altered to account for the fundamental difference between RF and baseband I/Q signals. For Spectrum measurements of I/Q signals this includes using a center frequency of 0 Hz for Spectrum views and the Spectrum Linear view. Occupied Bandwidth and Channel Power results are also displayed using a center frequency of 0 Hz.

The center frequency of baseband I/Q Spectrum displays is 0 Hz. Frequencies higher than 0 Hz are displayed as “positive” and those below 0 Hz are “negative”. The “negative” portion of a multi-channel baseband signal below 0 Hz corresponds to the portion of the signal that would lie below the carrier center frequency when it is upconverted, if no spectral inversion occurs. As 0 Hz is a fixed center frequency, the **FREQUENCY Channel** front-panel key has no active menu for baseband I/Q Spectrum measurements.

To view the Spectrum display of I only or Q only signals, use the Spectrum measurement capability in Basic Mode.

Waveform Views for Baseband I/Q Inputs

For Waveform measurements, two new displays are available exclusively for baseband I/Q input signals; the I and Q Waveform view, which separates the individual I and Q traces, and the I/Q Polar view. Since the horizontal axis for Waveform measurements is Time, the **FREQUENCY Channel** front-panel key has no active menu for baseband I/Q Waveform measurements. Use **Span** to change horizontal scale. A **Linear Envelope** view is also available to display baseband signals that employs linear voltage units on the vertical axis.

Waveform Signal Envelope Views of I only or Q only

To view the Signal Envelope display of I only or Q only signals, use the Waveform measurement capability in Basic Mode.

Comparing RF and Baseband I/Q Measurement Views

The following table compares the measurement views for RF inputs and baseband I/Q inputs.

Table 4-18 RF vs. Baseband I/Q Input Measurement Views by Measurement

Measurement	Views for RF Input Measurements	Views for Baseband I/Q Inputs Measurements	Mods to RF View for Baseband I/Q Inputs
Channel Power	Channel Power	Channel Power	Center Freq = 0 Hz
ACPR (ACLR)	FFT, Fast Bar Graph, Spectrum	Measurement Not Available	n/a
Intermodulation	IMD Spectrum	Measurement Not Available	n/a
Spectrum Emission Mask	Spectrum Views by Offset	Measurement Not Available	n/a
Occupied BW	Occupied BW	Occupied BW	Center Freq = 0 Hz
Code Domain	Power Graph & Metrics I/Q Error (Quad View) Code Domain (Quad View) Demod Bits table	Power Graph & Metrics I/Q Error (Quad View) Code Domain (Quad View) Demod Bits table	none
Mod Accuracy (Composite EVM)	I/Q Measured Polar Vector I/Q Measured Polar Constln I/Q Error (Quad View) Power Timing and Phase	I/Q Measured Polar Vector I/Q Measured Polar Constln I/Q Error (Quad View) Power Timing and Phase	none
QPSK EVM	I/Q Measured Polar Vector I/Q Measured Polar Constln I/Q Error (Quad View)	I/Q Measured Polar Vector I/Q Measured Polar Constln I/Q Error (Quad View)	none
Power Stat CCDF	CCDF	CCDF	none
Spectrum (Freq Domain)	Spectrum Spectrum Linear I and Q Waveform I/Q Polar	Spectrum Spectrum Linear I and Q Waveform I/Q Polar	Center Freq = 0 Hz (Spectrum Views) Y axis = V, dBm (Spectrum Linear)
Waveform (Time Domain)	Signal Envelope I/Q Waveform I/Q Polar	Signal Envelope I/Q Waveform I/Q Polar Linear Envelope I and Q Waveform	Y axis = V, dBm (Linear Envelope)

Results screens for the above measurements unique to baseband I/Q inputs are shown in the section [“Baseband I/Q Measurement Result Examples”](#) on page 170.

Other Sources of Measurement Information

Additional measurement application information is available through your local Agilent Technologies sales and service office. The following application notes treat digital communications measurements in much greater detail than discussed in this measurement guide.

- Application Note 1298
Digital Modulation in Communications Systems - An Introduction
Agilent part number 5965-7160E
- Application Note 1311
Understanding CDMA Measurements for Base Stations and Their Components
Agilent part number 5968-0953E
- Application Note 1355
Designing and Testing W-CDMA User Equipment
Agilent part number 5980-1239E
- Application Note 1356
Designing and Testing 3GPP W-CDMA Base Stations
Agilent part number 5980-1238E
- Application Note
Characterizing Digitally Modulated Signals with CCDF Curves
Agilent part number 5968-5858E
- Application Note
HSDPA RF Measurements for User Equipment
Agilent part number 5989-4099EN
- Product Note
PSA Series Spectrum Analyzers E4406A Vector Signal Analyzer
W-CDMA and HSDPA Measurement Personalities, Technical
Overview with Self-Guided Demonstration Options BAF and 210
Agilent part number 5989-2388EN

Instrument Updates at www.agilent.com

These web locations can be used to access the latest information about the instrument, including the latest firmware version.

<http://www.agilent.com/find/vsa>

<http://www.agilent.com/find/psa>

References

1. 3G Market Overview and Technology Basics for cdma2000 and TRA (ETSI W-CDMA). Agilent Technologies Wireless R&D Symposium, 1999.
2. 3rd Generation Partnership Project. Technical Specification Group Radio Access Network; Multiplexing and Channel Coding (FDD). Release 99. 3G TS 25.212 (V3.11.0).
3. 3rd Generation Partnership Project. Technical Specification Group Radio Access Network. Medium Access Control Protocol Specification. Release 99. 3G TS 25.321.
4. 3rd Generation Partnership Project. Technical Specification Group Radio Access Network. Radio Link Control Protocol Specification. Release 99. 3G TS 25.322.
5. 3rd Generation Partnership Project. Technical Specification Group Radio Access Network. Radio Resource Control Protocol Specification. Release 99. 3G TS 25.331.
6. 3rd Generation Partnership Project. Technical Specification Group Radio Access Network. Radio Interface Protocol Architecture. Release 99. 3G TS 25.301.
7. 3rd Generation Partnership Project. Technical Specification Group Radio Access Network; Physical Layer: Physical Channels and Mapping of Transport Channels onto Physical Channels (FDD). Release 99. 3G TS 25.211 (V3.12.0).
8. HPSK Spreading for 3G, Application Note 1335, literature number 5968-8438E.
9. 3rd Generation Partnership Project. Technical Specification Group Radio Access Network; Physical Layer: Spreading and Modulation (FDD). Release 99. 3G TS 25.213 (V3.8.0).
10. 3rd Generation Partnership Project. Technical Specification Group Radio Access Network. Physical Layer: Channel Coding and Multiplexing Examples. Release 99. 3G TS 25.944. (V3.5.0).
11. R.N. Braithwaite, Nonlinear Amplification of CDMA Waveforms: An Analysis of Power Amplifier Gain Errors and Spectral Regrowth. Proceedings of the 48th IEEE Vehicular Technology Conference (1998): 2160-2166.
12. 3rd Generation Partnership Project. Technical Specification Group Terminal; Terminal Conformance Specification. Radio Transmission and Reception (FDD). Release 99. 3G TS 34.121 (V3.8.0).
13. Fundamentals of RF and Microwave Power Measurements, Application Note 64-1B, literature number 5965-6630E.

14. Wide-Range Sensor Gauges Power of Complex Signals (written by Ron Hogan and originally printed in *Microwaves & RF*, September 1999), literature number 5968-8750E.
15. Characterizing Digitally Modulated Signals with CCDF Curves, Application Note, literature number 5968-6875E.
16. Testing and Troubleshooting Digital RF Communications Transmitter Designs, Application Note 1313, literature number 5968-3578E.
17. Testing and Troubleshooting Digital RF Communications Receiver Designs, Application Note 1314, literature number 5968-3579E.
18. 3rd Generation Partnership Project. Technical Specification Group Radio Access Network; UE Radio Transmission and Reception (FDD). Release 99. 3G TS 25.101 (V3.5.0).
19. Connected Simulations and Test Solutions Using the Advanced Design System, Application Note 1394, literature number 5988-6044EN.
20. 3rd Generation Partnership Project. Technical Specification Group Radio Access Network; UTRAN Overall Description. Release 99. 3G TS 25.401 (V3.10.0)
21. 3GPP TS 25.141 Base Station (BS) conformance testing (FDD) (Release 5) V5.8.0 (2003-12)
22. 3GPP TS 25.211 Physical channels and mapping of transport channels onto physical channels (FDD) (Release 5) V5.5.0 (2003-9)
23. 3GPP TS 25.213 Spreading and modulation (FDD) (Release 5) V5.5.0 (2003-12)
24. 3GPP TS 25.214 Physical layer procedure (FDD) (Release 5) V5.7.0 (2003-12)
25. 3GPP TS 34.121 Terminal conformance specification; Radio transmission and reception (FDD) (Release 5) V5.1.1 (2003-12)
26. 3GPP TS 25.141 Base Station (BS) conformance testing (FDD) (Release 5) V6.10.0 (2005-06)
27. 3GPP TS 25.211 Physical channels and mapping of transport channels onto physical channels (FDD) V6.5.0 (2005-06)
28. 3GPP TS 25.212 Multiplexing and channel coding (FDD) V6.5.0(2005-06)
29. 3GPP TS 25.213 Spreading and modulation (FDD) V6.3.0 (2005-06)
30. 3GPP TS 25.214 Physical layer procedure (FDD) V6.6.0 (2005-06)
31. 3GPP TS 34.121 Terminal conformance specification; Radio transmission and reception (FDD) V6.1.0 (2005-06)

5**Menu Maps**

These menu maps are in alphabetical order by the front panel key label or oval cross-reference label. You can locate detailed information about each key/function at the page number listed in the figure title for each menu.

W-CDMA (3GPP) Measurement Key Flow

The key flow diagrams, shown in a hierarchical manner on the following pages, will help grasp the overall functional relationships for the front-panel keys and the softkeys displayed at the extreme right side of the screen. The diagrams are:

- “MODE Selection Key Flow” on page 515
- “Mode Setup/FREQUENCY Channel Key Flow (1 of 2)” on page 516
- “Measurement Selection Key Flow” on page 518
- “Channel Power Measurement Key Flow” on page 519
- “ACPR (ACLR) Measurement Key Flow (1 of 2)” on page 520
- “Intermodulation Measurement Key Flow” on page 522
- “Multi Carrier Power Measurement Key flow (1 of 2)” on page 523
- “Spectrum Emission Mask Measurement Key Flow (1 of 2)” on page 525
- “Occupied Bandwidth Measurement Key Flow” on page 527
- “Code Domain Measurement Key Flow (1 of 7)” on page 528
- “Modulation Accuracy Measurement Key Flow (1 of 5)” on page 535
- “QPSK EVM Measurement Key Flow (1 of 2)” on page 540
- “Power Stat CCDF Measurement Key Flow” on page 542
- “Spectrum (Freq Domain) Measurement Key Flow (1 of 4)” on page 543
- “Waveform (Time Domain) Measurement Key Flow (1 of 3)” on page 547
- “Power vs. Time Measurement Key Flow (1 of 2)” on page 550
- “Power Control Measurement Key Flow (1 of 2)” on page 552

NOTE

For E4406A, Option B7C, if **Input Port** is set to either **I/Q, I only**, or **Q only** with the Option B7C “Baseband I/Q Inputs”, the **ACPR (ACLR)**, **Intermod**, **Multi Carrier Power**, and **Spectrum Emission Mask** measurements are not available.

Directions for Use

Refer to the following notices to utilize the key flow diagrams:

- There are some basic conventions:

View/Trace

An oval represents one of the front-panel keys.

QPSK EVM

This box represents one of the softkeys displayed.

<for EVM>

This represents an explanatory description on its specific key.

Avg Number 10 On|Off

This box shows how the softkey default condition is displayed. Default parameters or values are underlined wherever possible.

- Start from the upper left corner of each measurement diagram. Go to the right, and go from the top to the bottom.
- When changing a key from auto (with underline) to manual, just press that key one time.
- When entering a numeric value for **frequency**, a value with units, use the numeric keypad and terminate the entry with the appropriate unit selection from the softkeys displayed.
- When entering a numeric value for a unitless value, like **Avg Number**, use the numeric keypad and terminate the entry with the **Enter** front-panel key.
- Instead of using the numeric keypad to enter a value, it may be easier to use the RPG knob or **Up/Down** arrow keys.

Figure 5-1

MODE Selection Key Flow

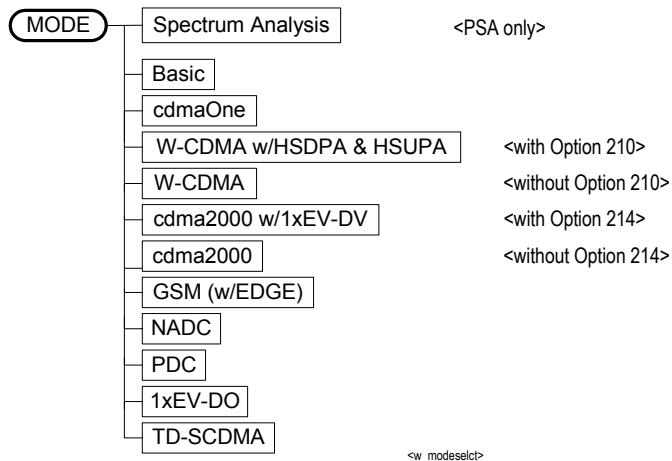


Figure 5-2 Mode Setup/FREQUENCY Channel Key Flow (1 of 2)

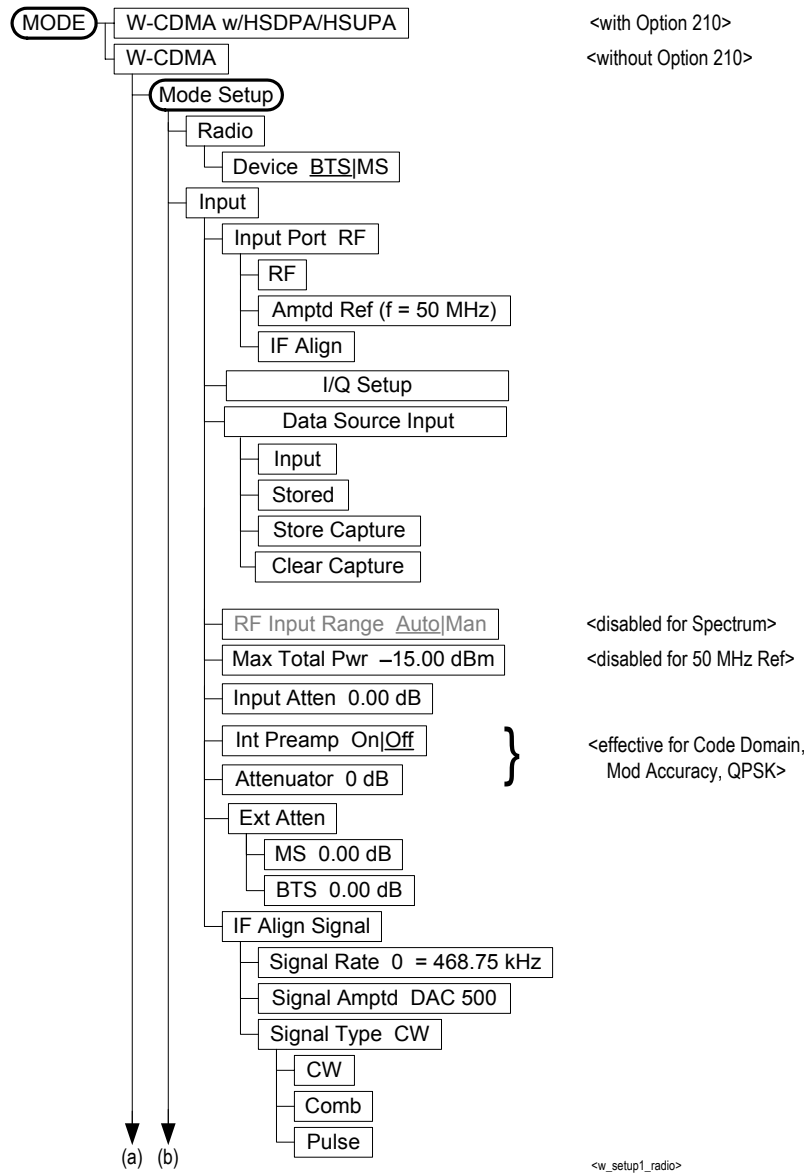
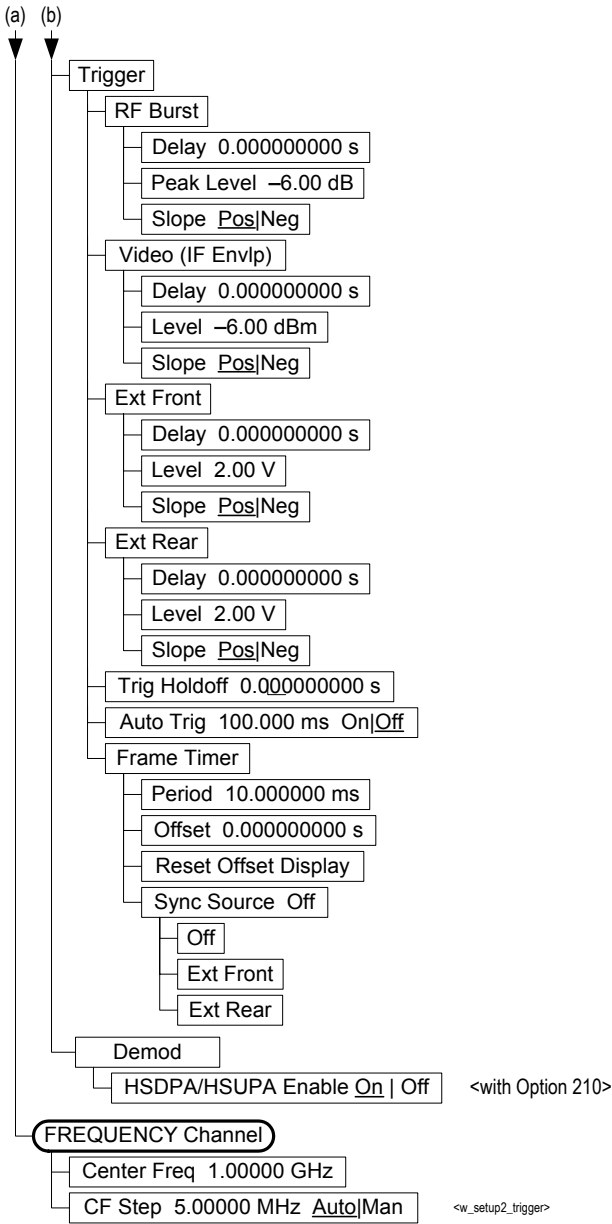


Figure 5-3 Mode Setup/FREQUENCY Channel Key Flow (2 of 2)



Menu Maps

Figure 5-4 Measurement Selection Key Flow

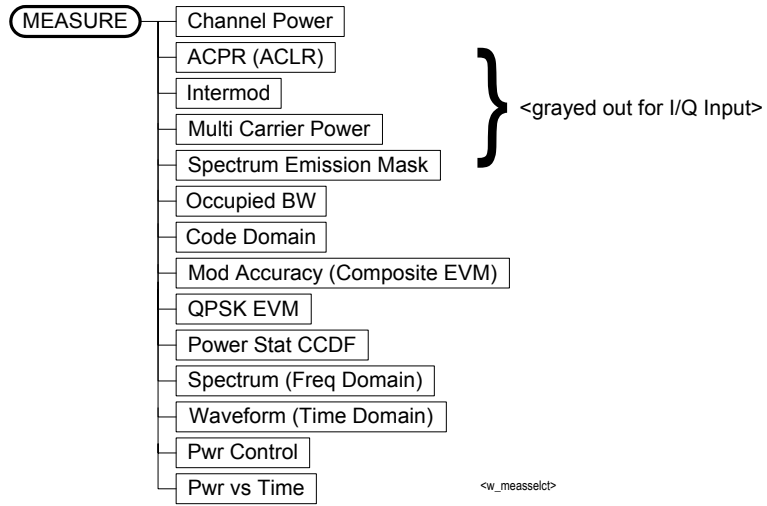


Figure 5-5 Channel Power Measurement Key Flow

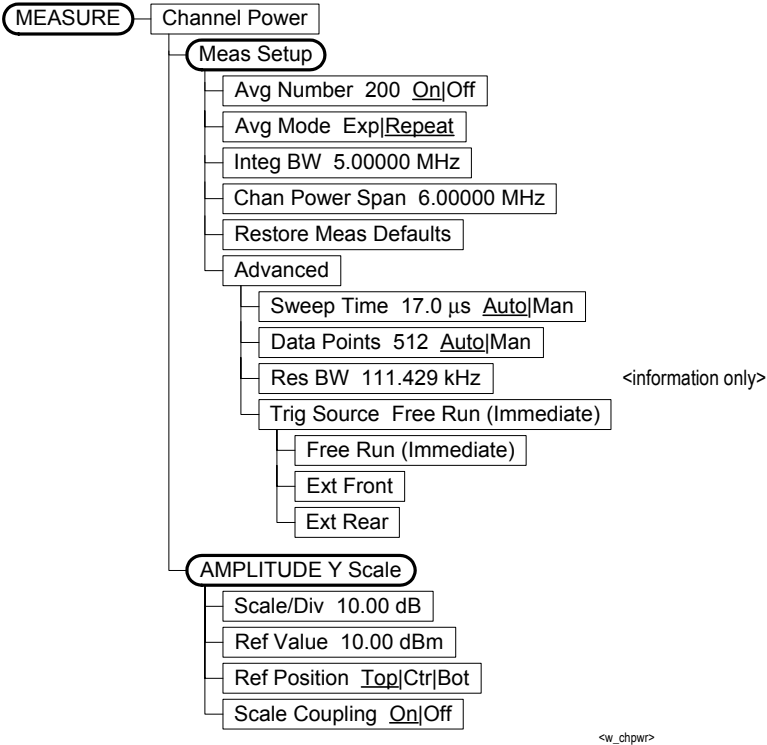
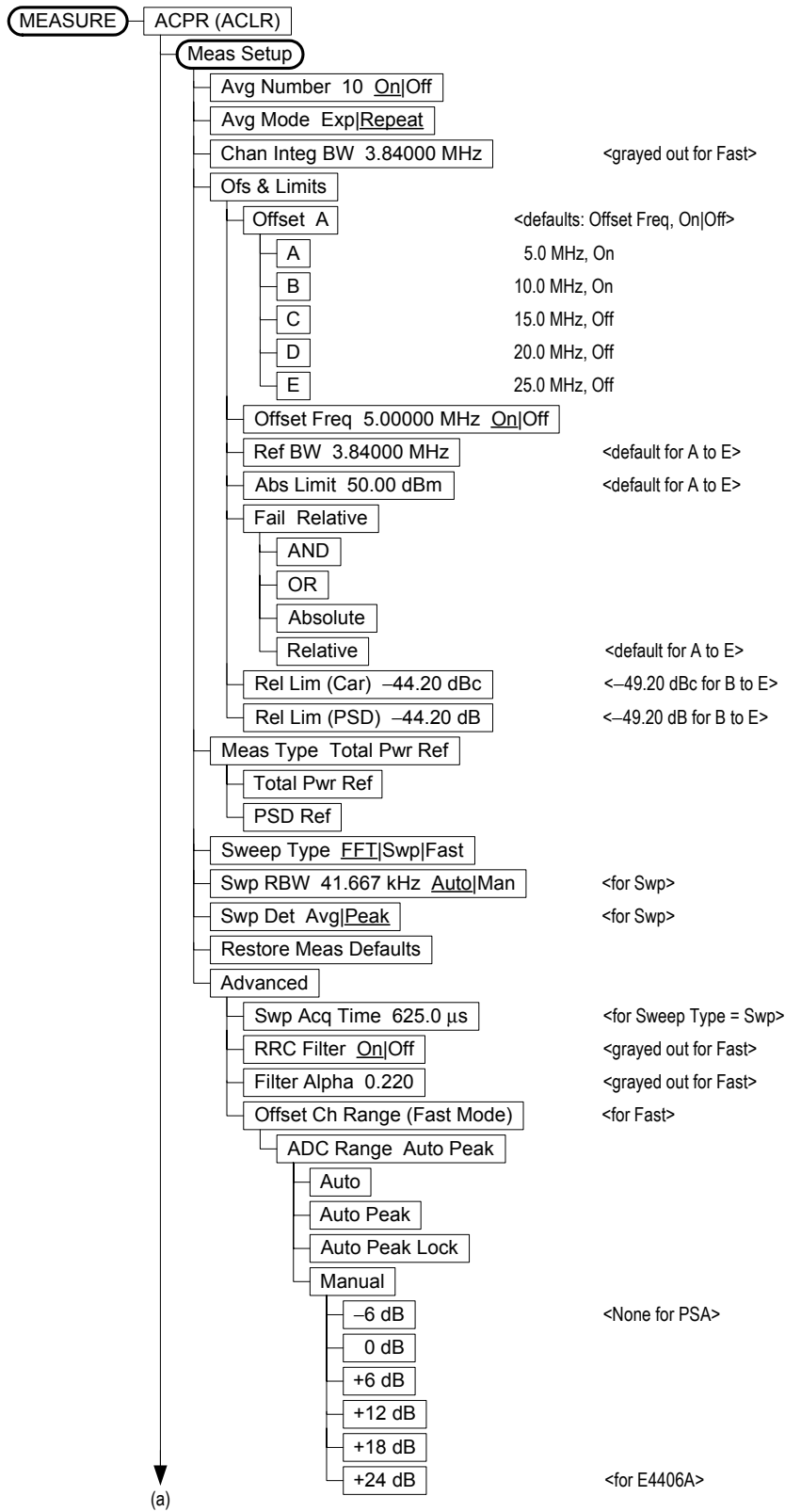


Figure 5-6 ACPR (ACLR) Measurement Key Flow (1 of 2)



<w_acpr1_setup>

Figure 5-7 ACPR (ACLR) Measurement Key Flow (2 of 2)

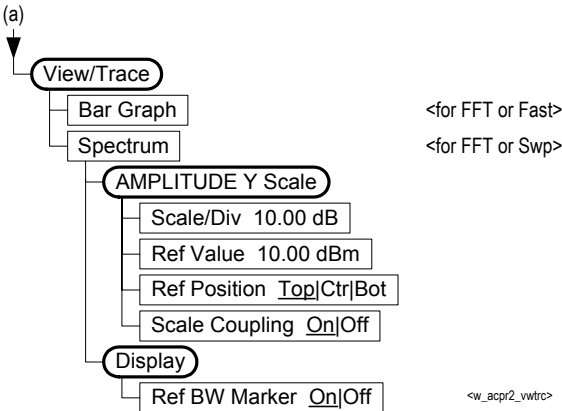


Figure 5-8 Intermodulation Measurement Key Flow

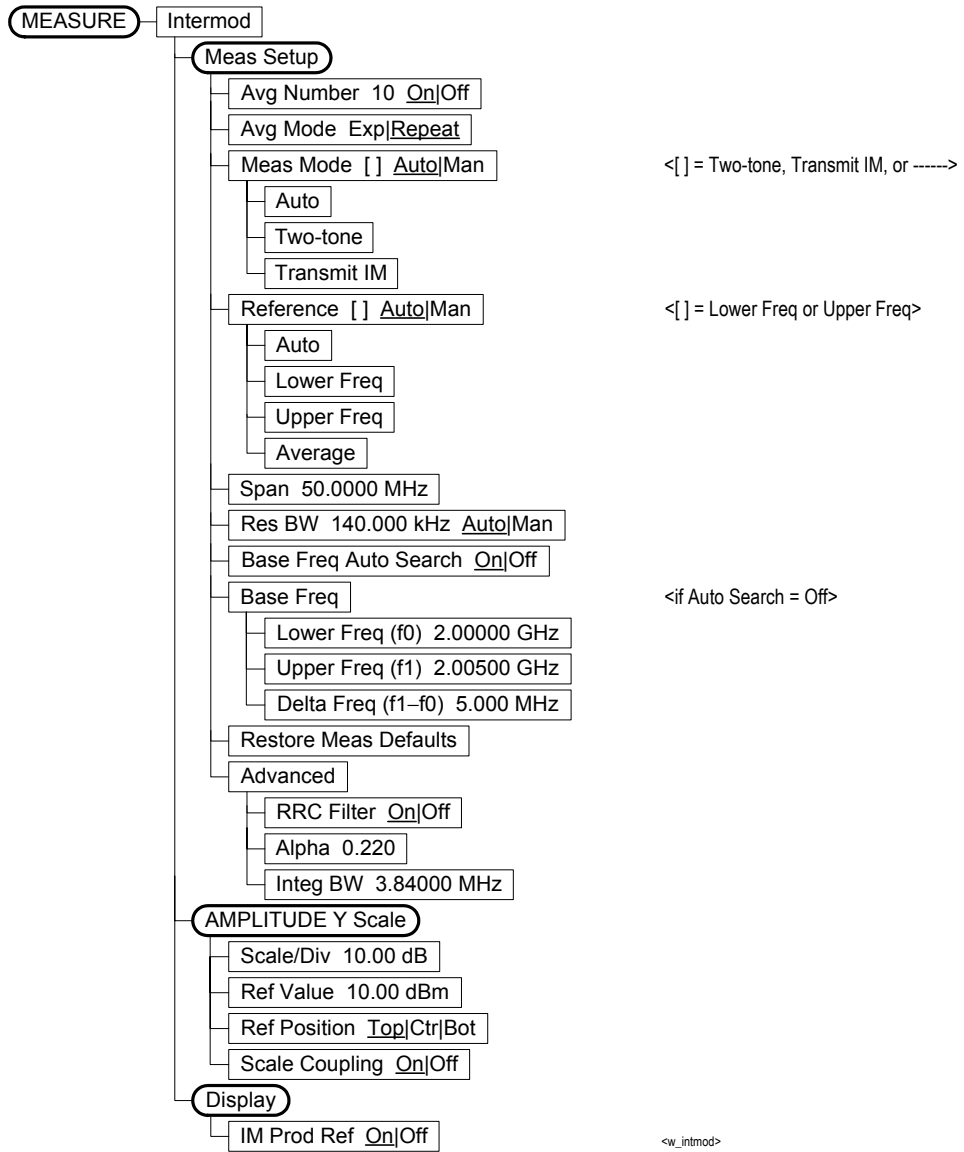
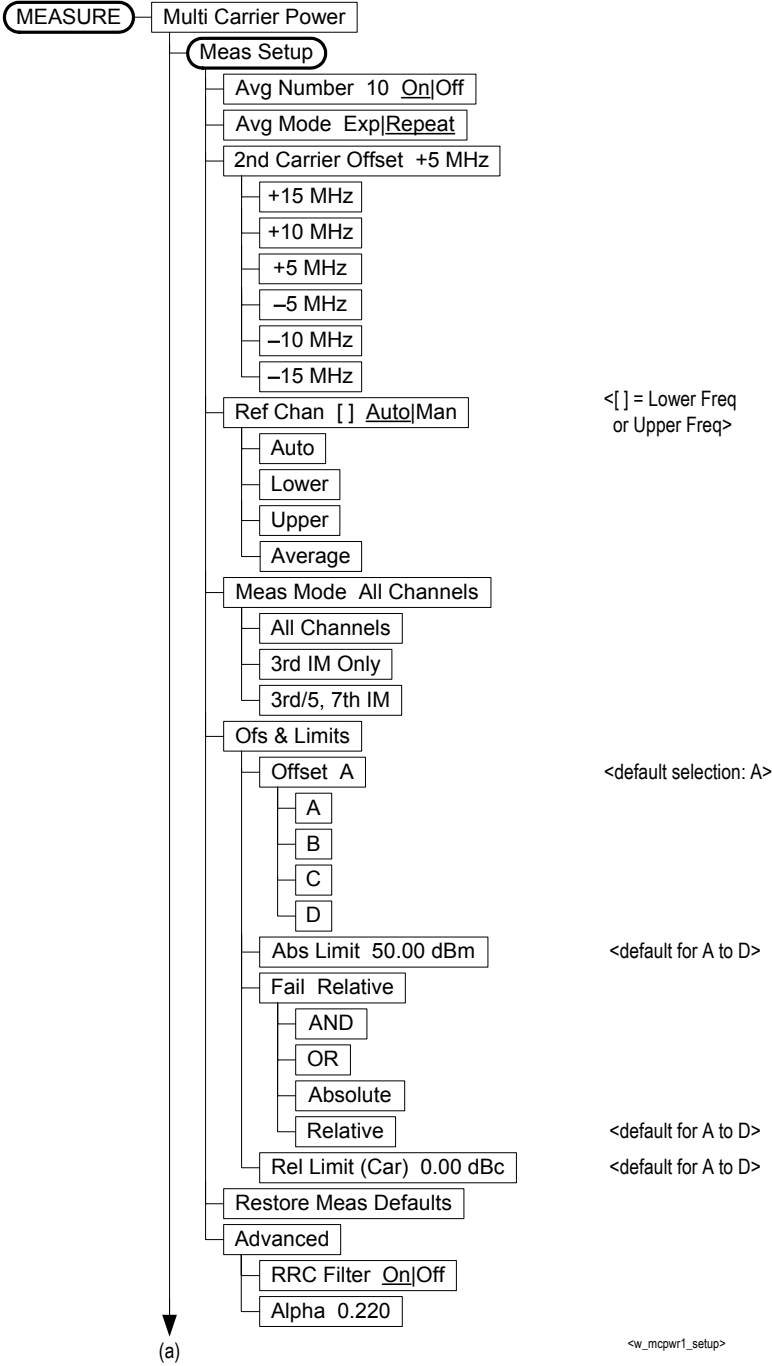


Figure 5-9 Multi Carrier Power Measurement Key flow (1 of 2)



Menu Maps

Figure 5-10 Multi Carrier Power Measurement Key Flow (2 of 2)

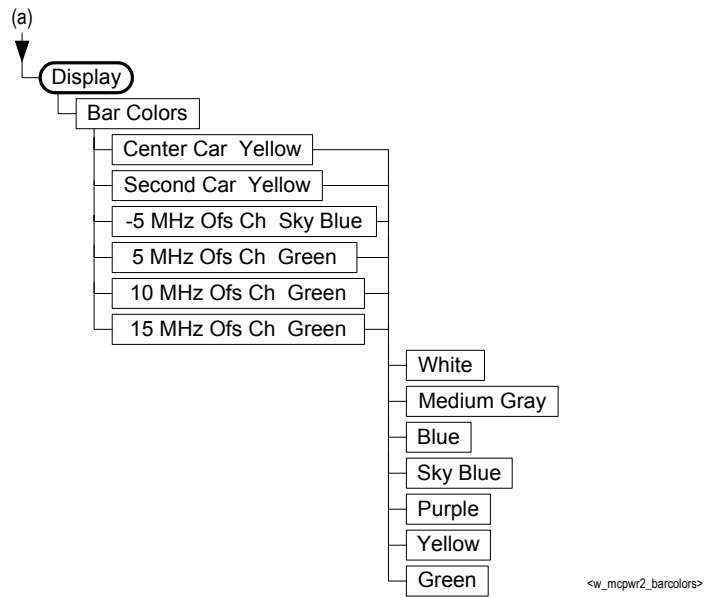
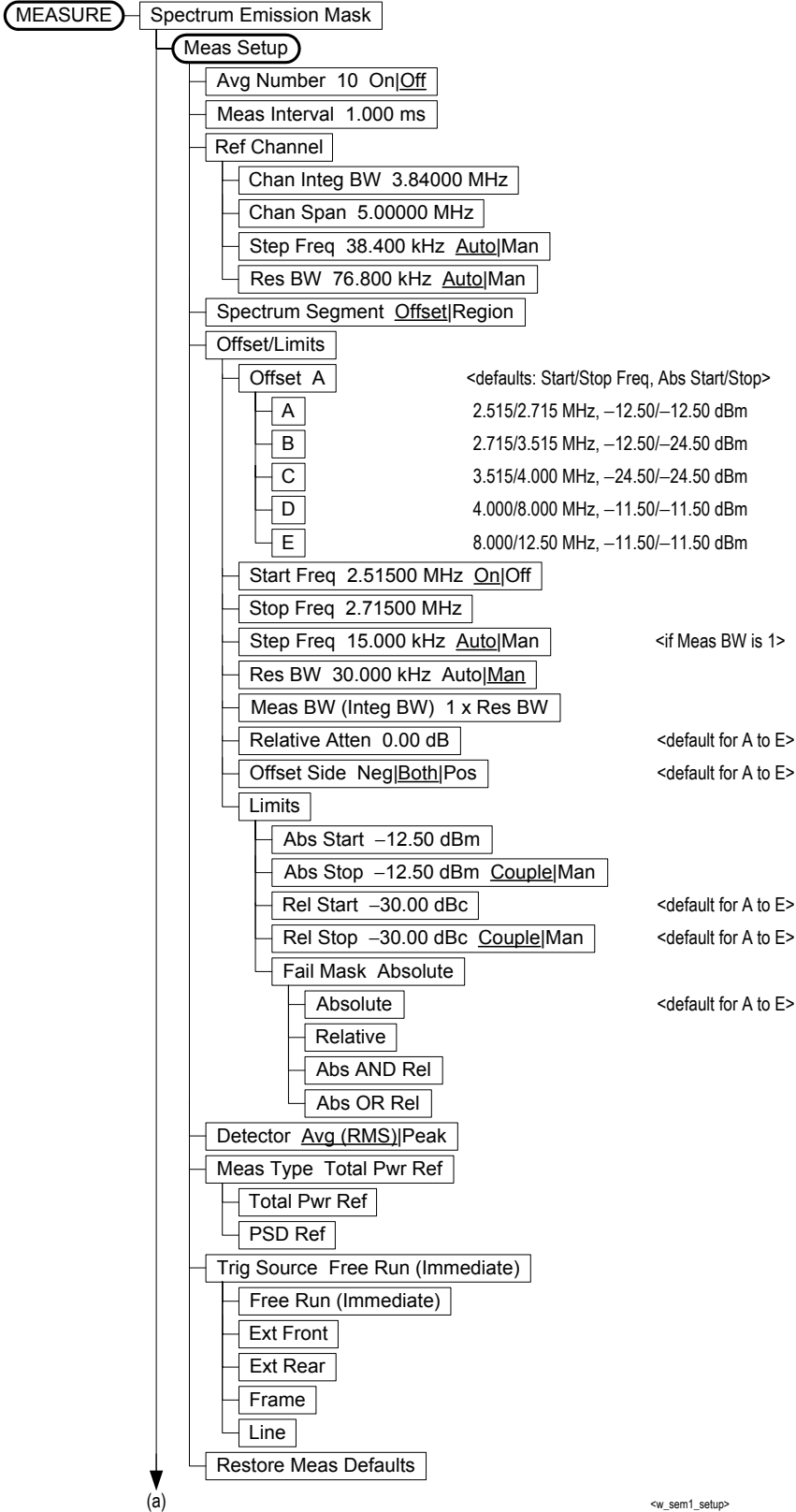


Figure 5-11 Spectrum Emission Mask Measurement Key Flow (1 of 2)



Menu Maps

Figure 5-12 Spectrum Emission Mask Measurement Key Flow (2 of 2)

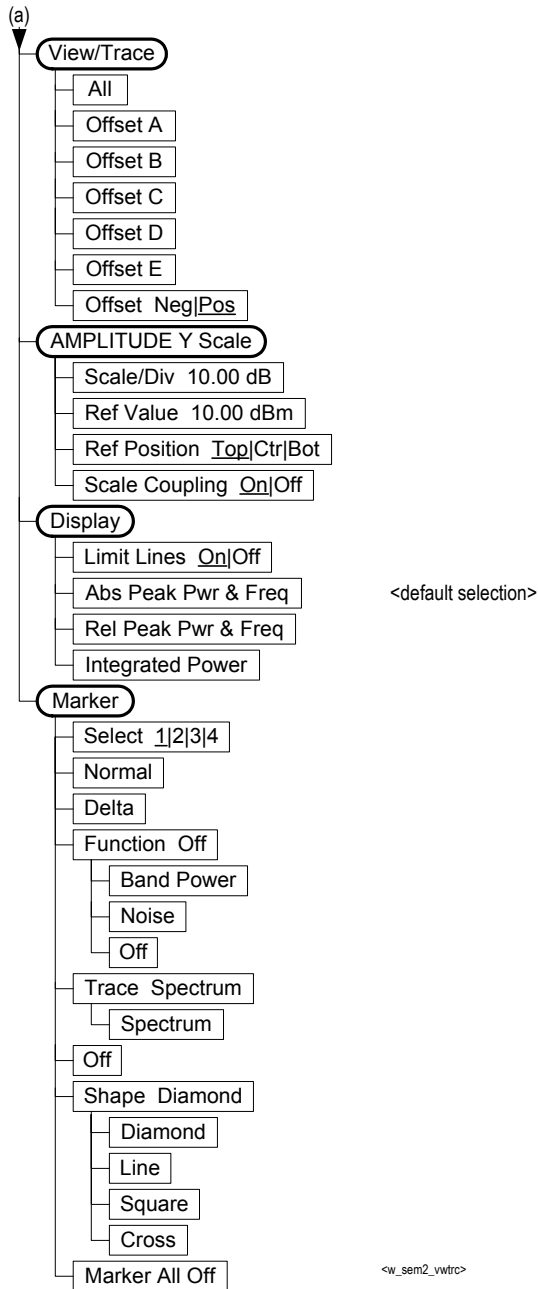
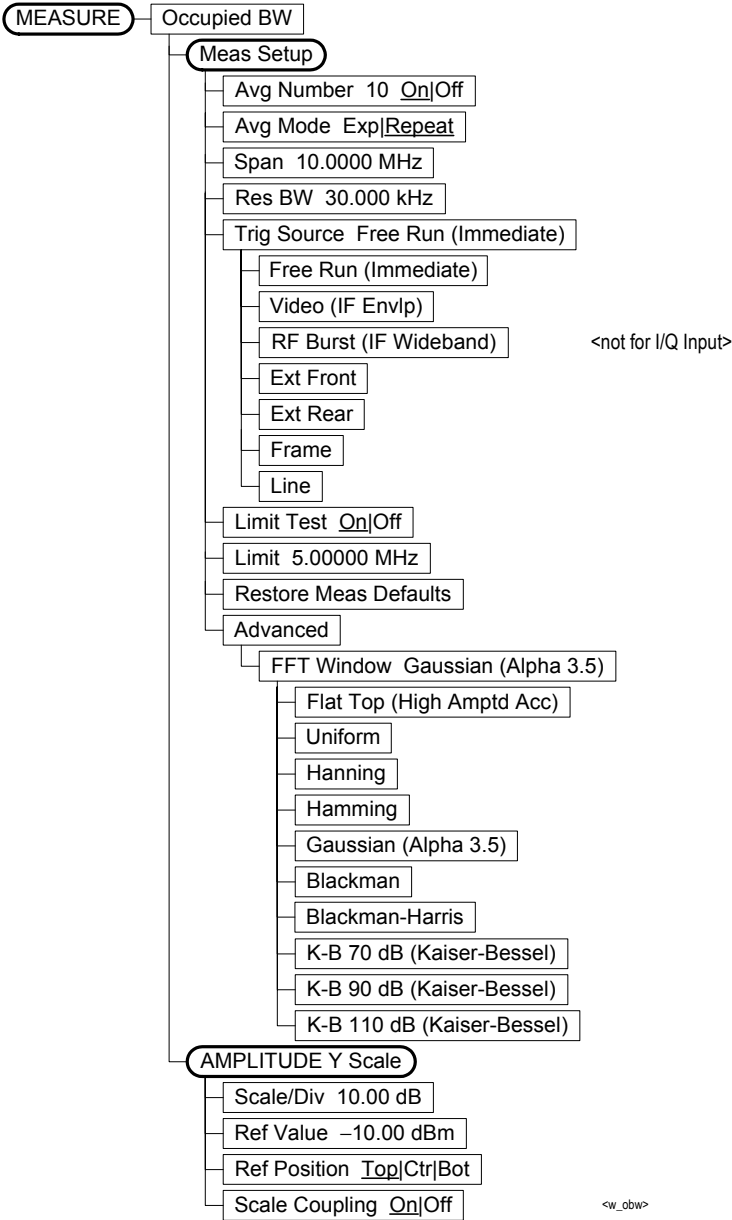


Figure 5-13 Occupied Bandwidth Measurement Key Flow



Menu Maps

Figure 5-14 Code Domain Measurement Key Flow (1 of 7)

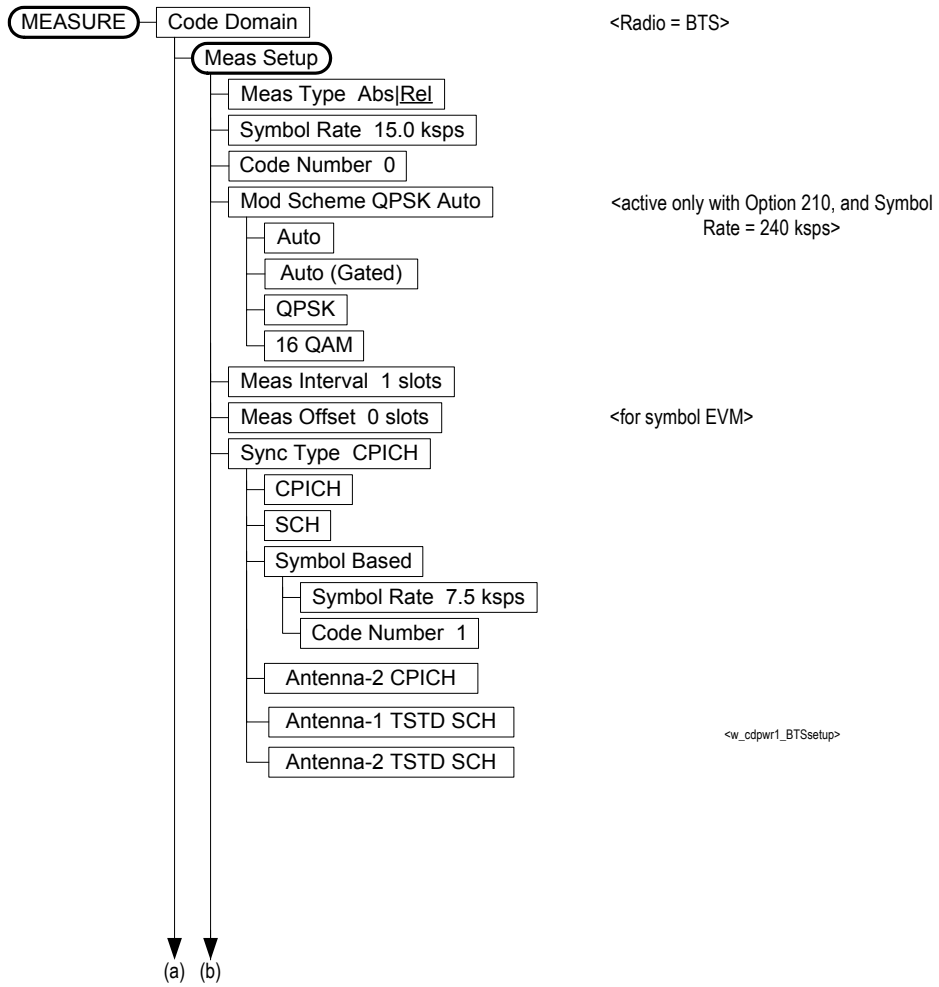
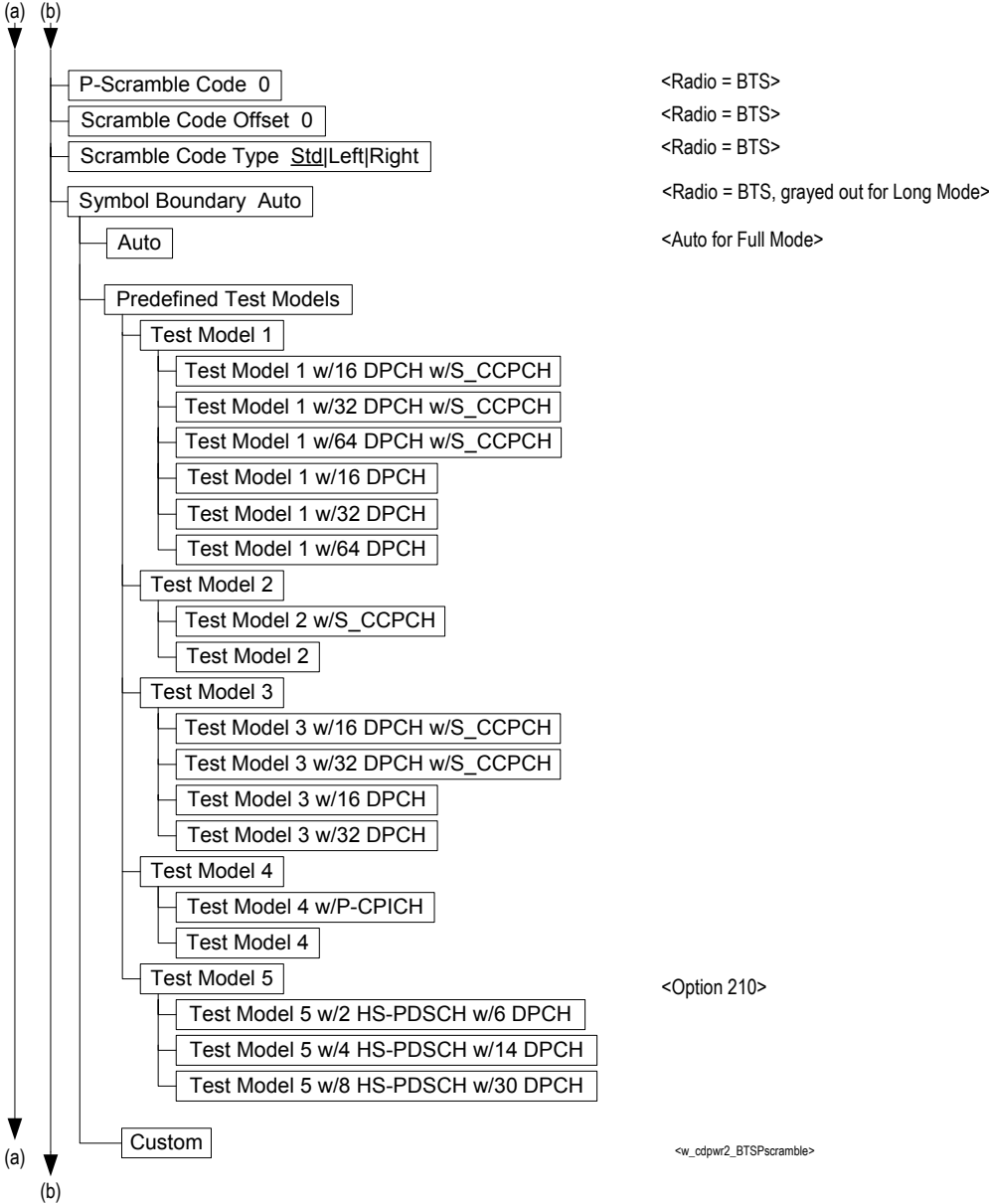
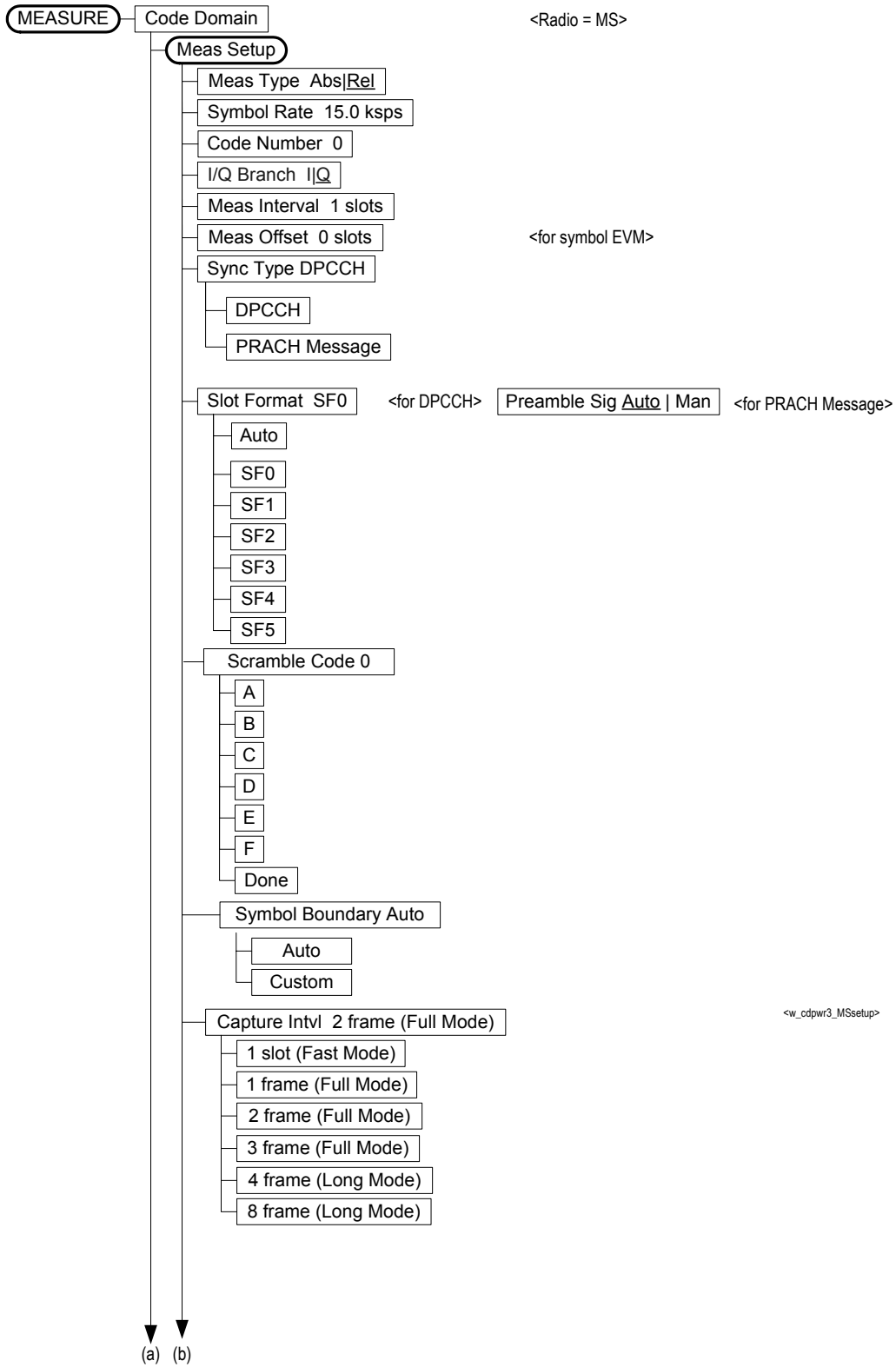


Figure 5-15 Code Domain Measurement Key Flow (2 of 7)



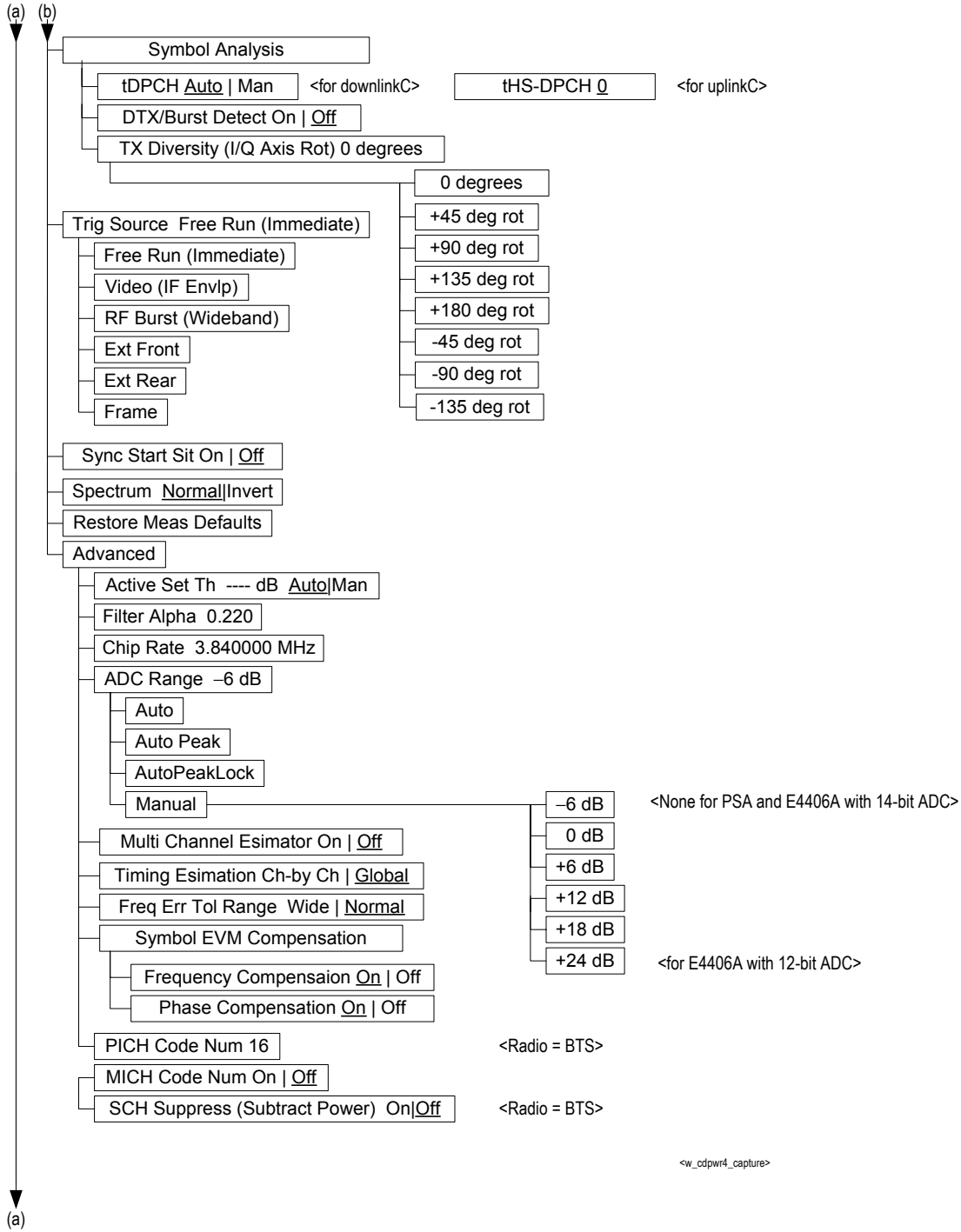
Menu Maps

Figure 5-16 Code Domain Measurement Key Flow (3 of 7)



Menu Maps

Figure 5-17 Code Domain Measurement Key Flow (4 of 7)



Menu Maps

Figure 5-18 Code Domain Measurement Key Flow (5 of 7)

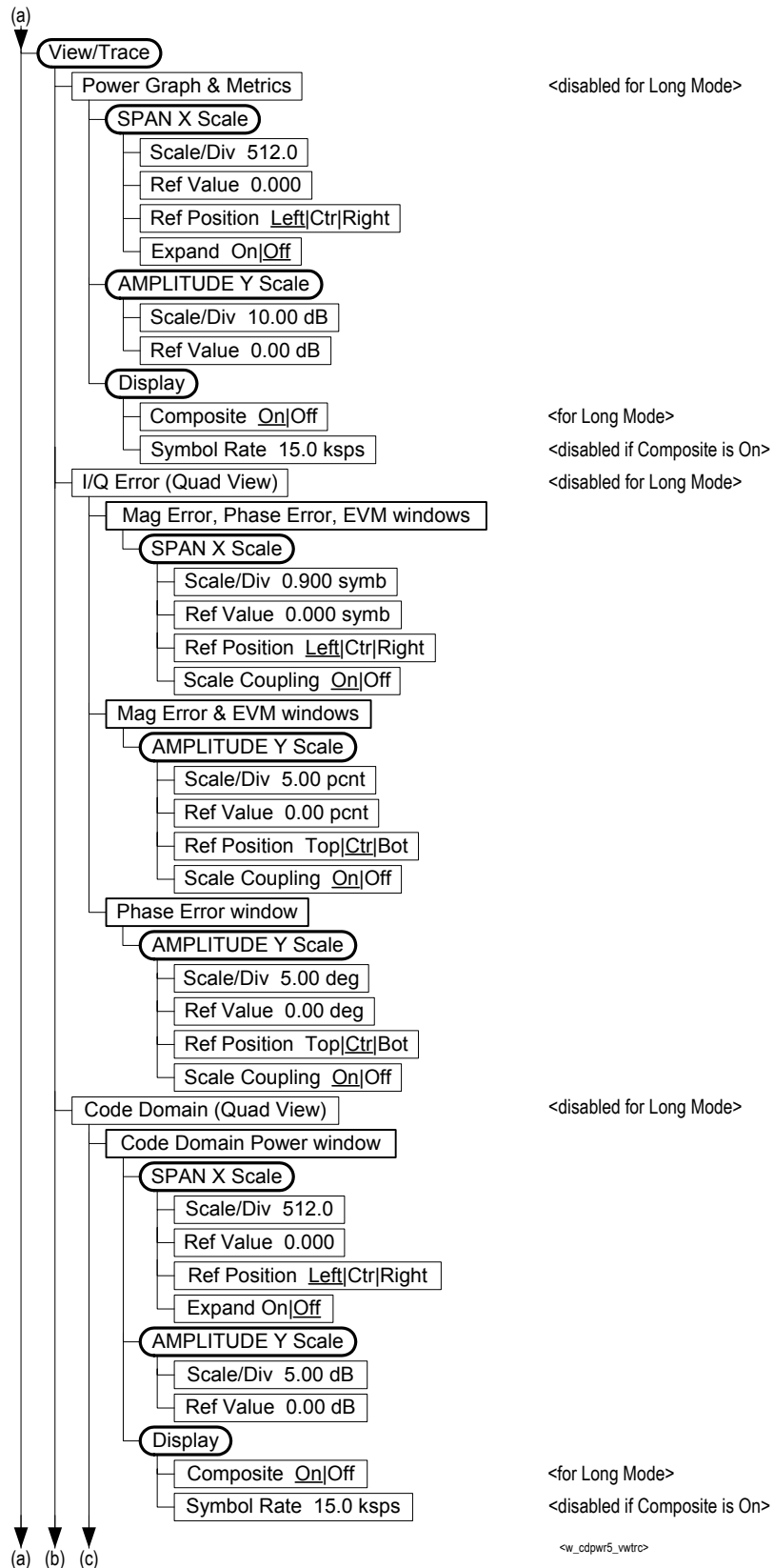
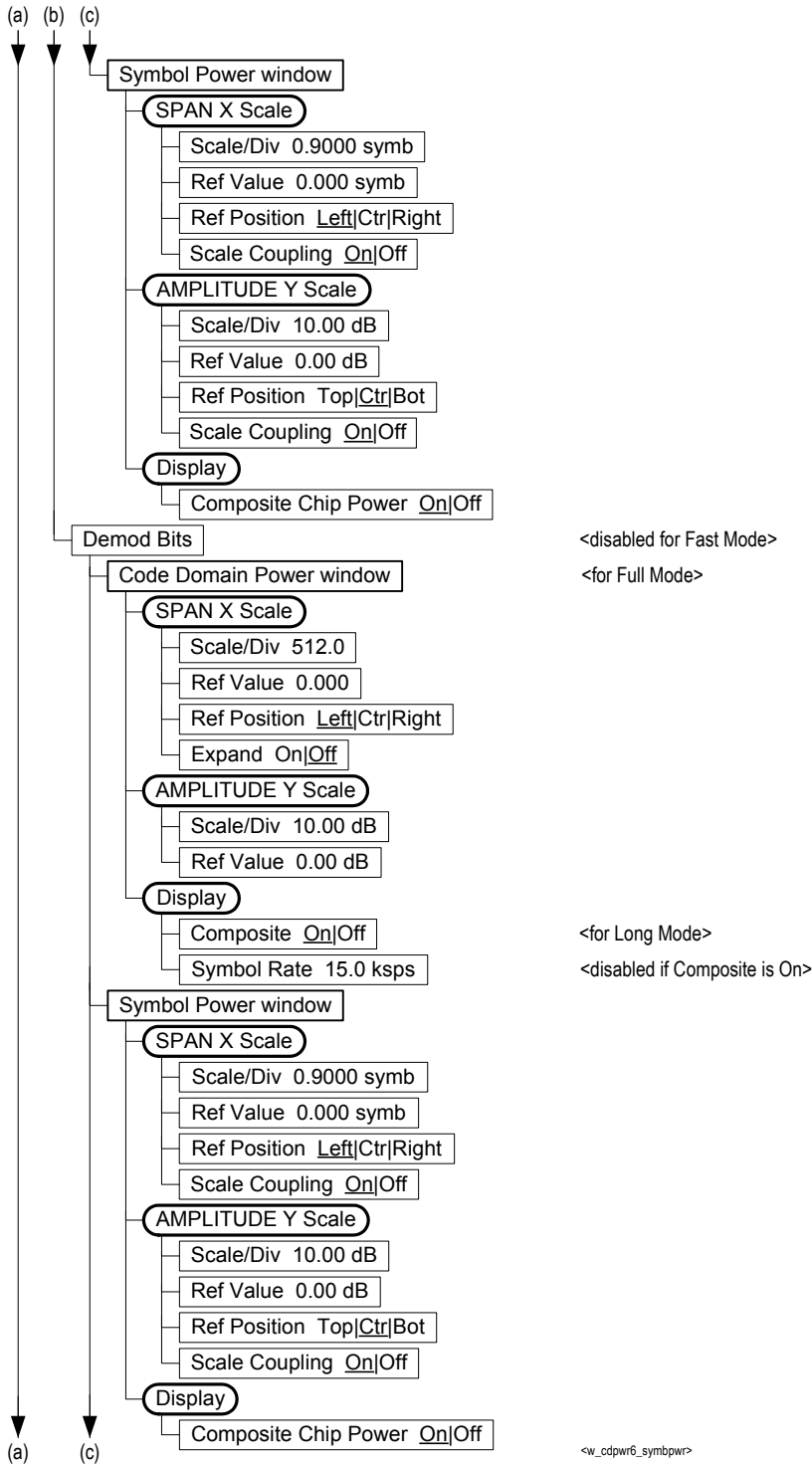


Figure 5-19 Code Domain Measurement Key Flow (6 of 7)



Menu Maps

Figure 5-20 Code Domain Measurement Key Flow (7 of 7)

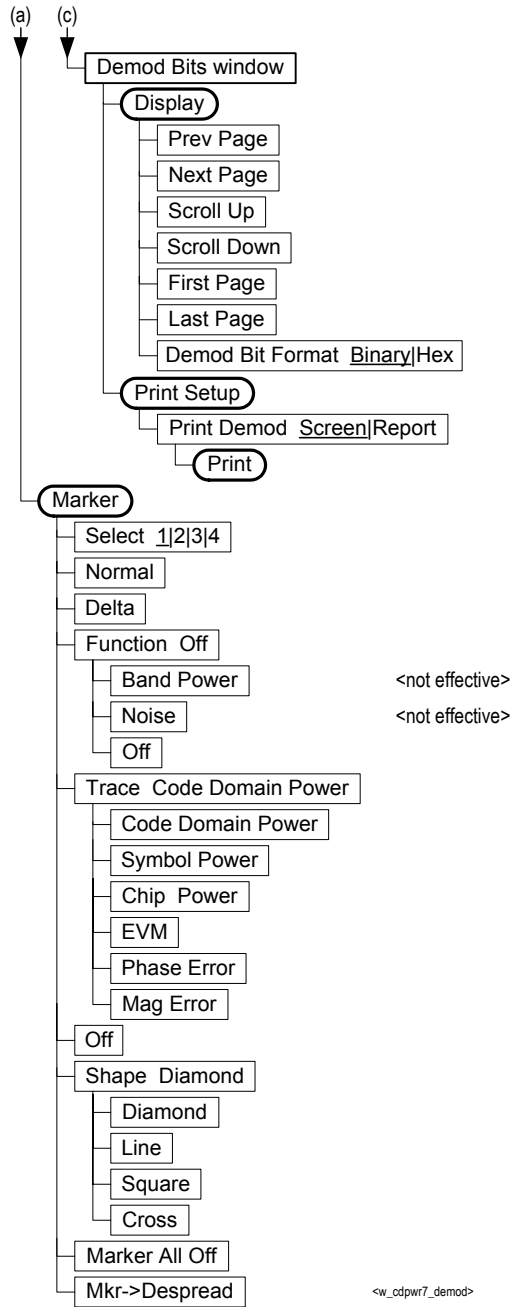
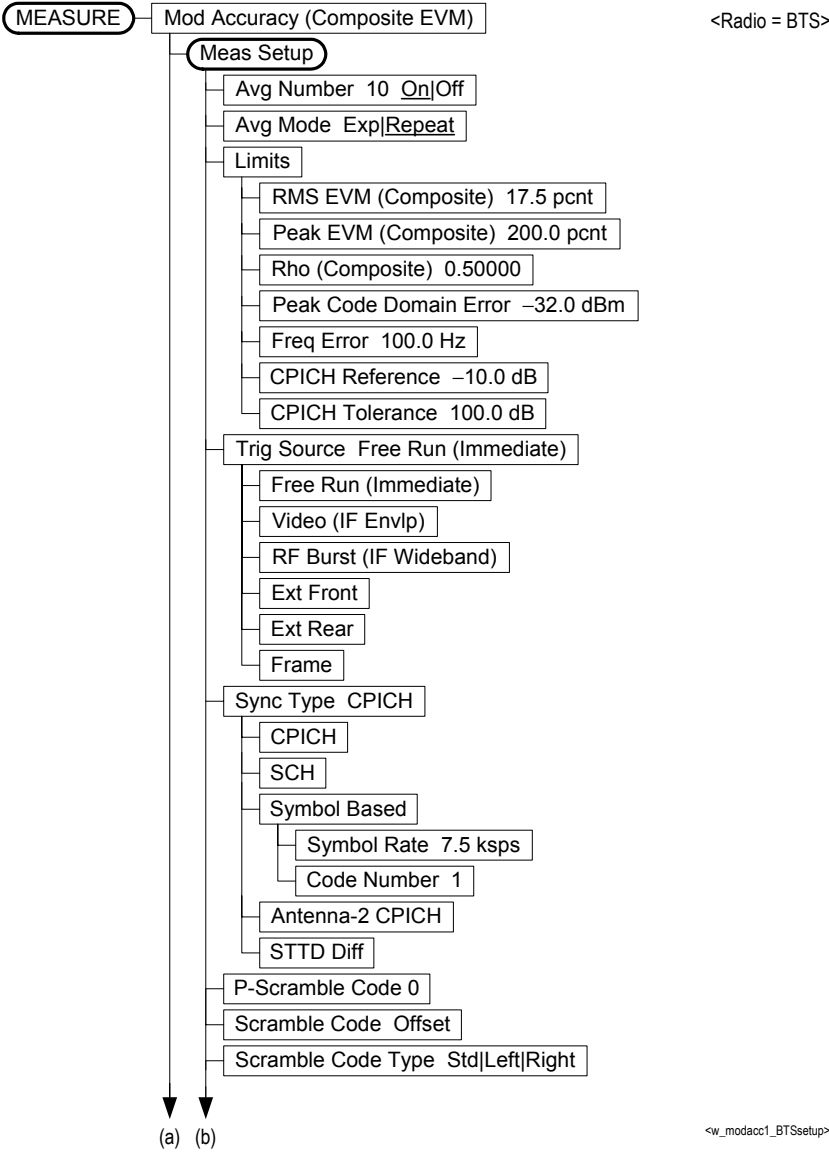


Figure 5-21 Modulation Accuracy Measurement Key Flow (1 of 5)



Menu Maps

Figure 5-22 Modulation Accuracy Measurement Key Flow (2 of 5)

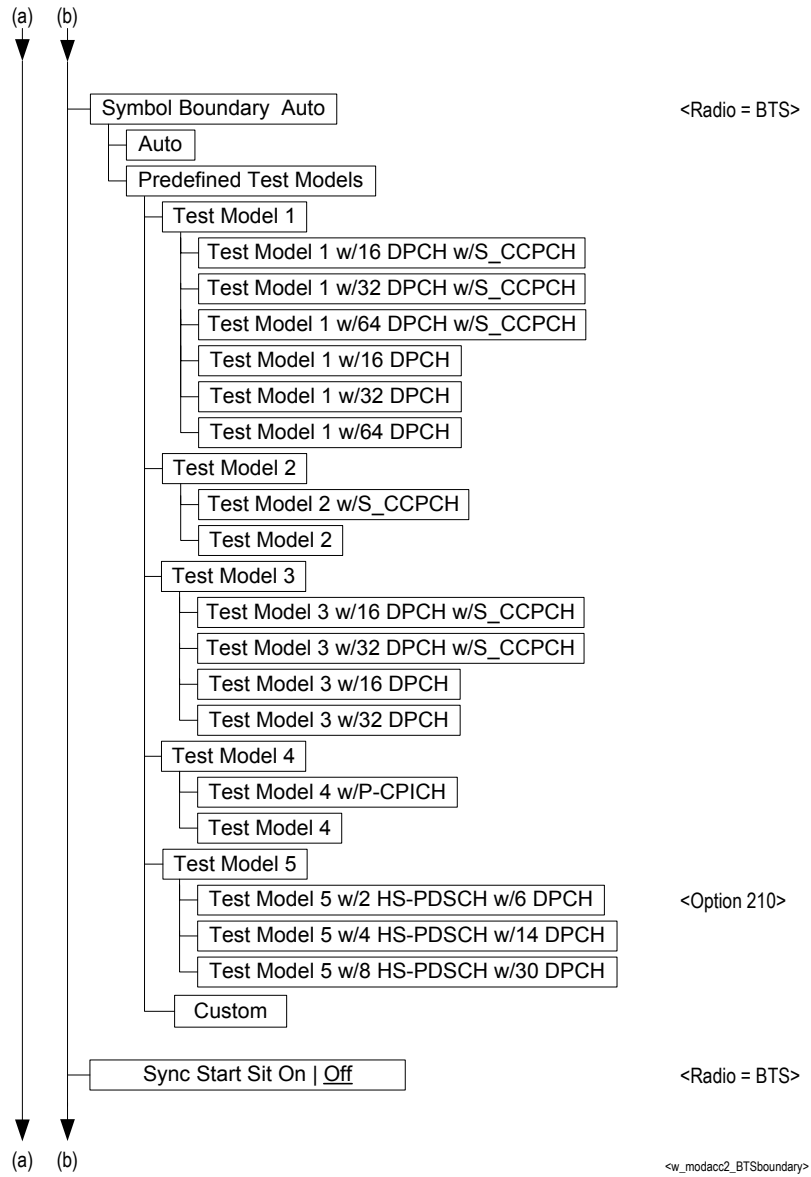
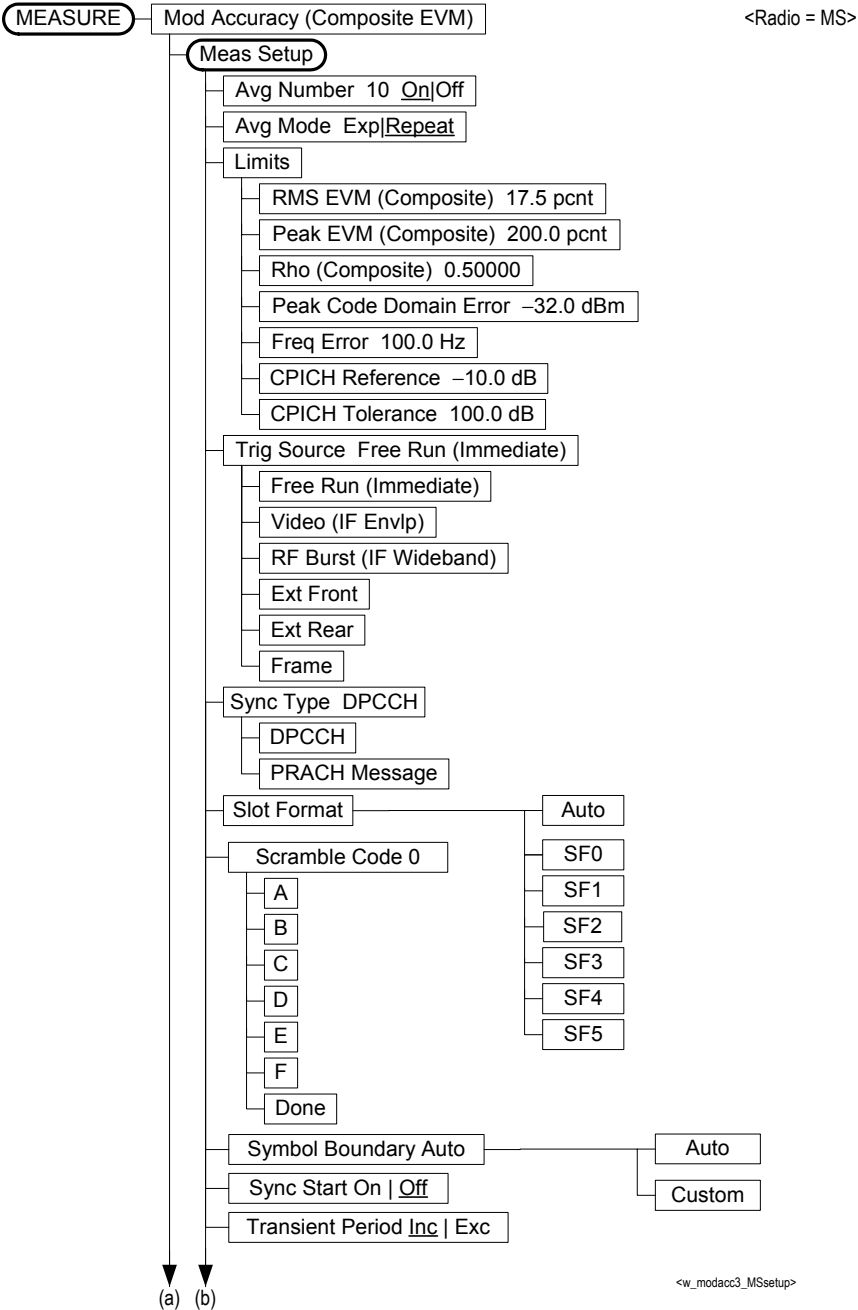
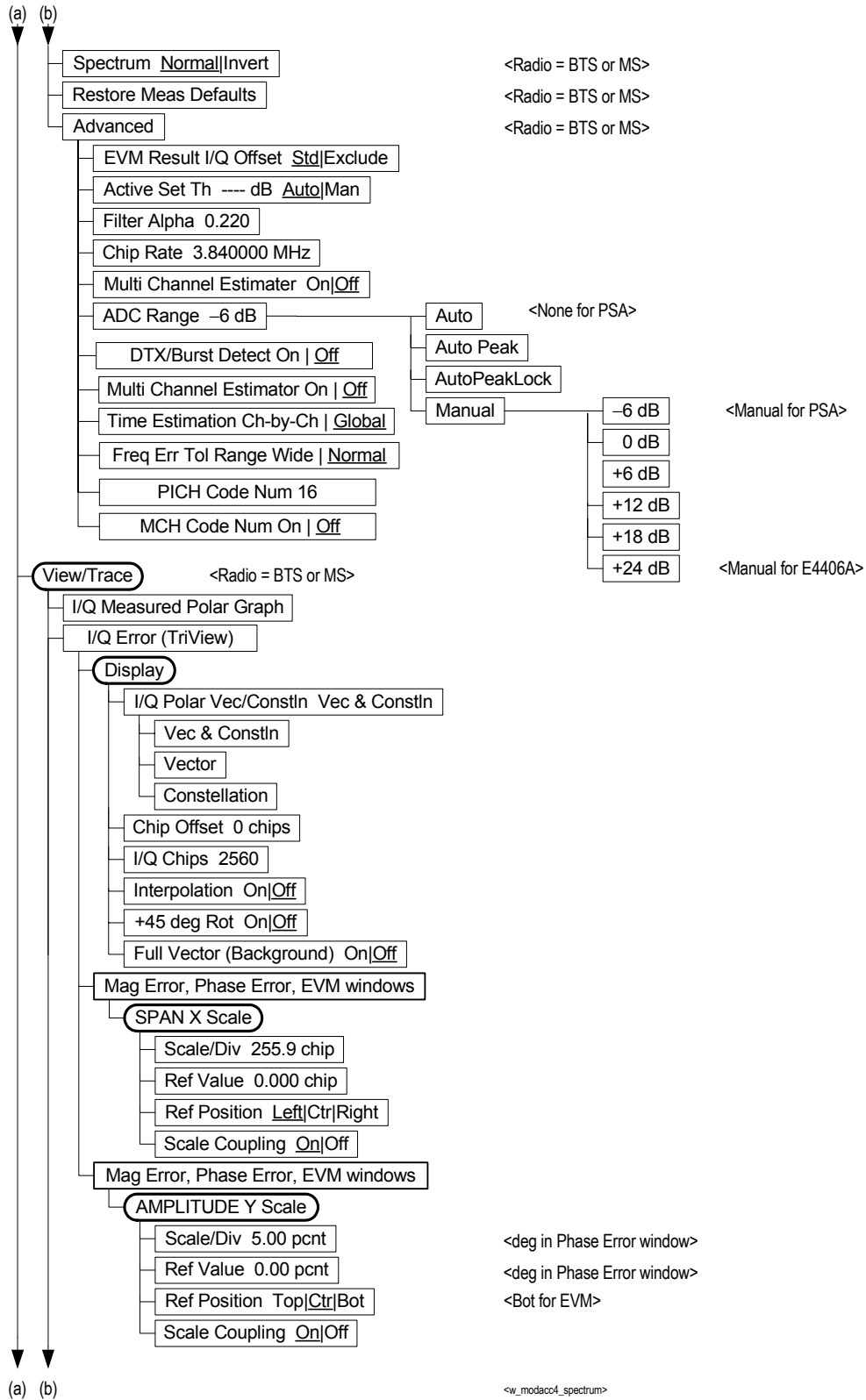


Figure 5-23 Modulation Accuracy Measurement Key Flow (3 of 5)



Menu Maps

Figure 5-24 Modulation Accuracy Measurement Key Flow (4 of 5)



Menu Maps

Figure 5-25 Modulation Accuracy Measurement Key Flow (5 of 5)

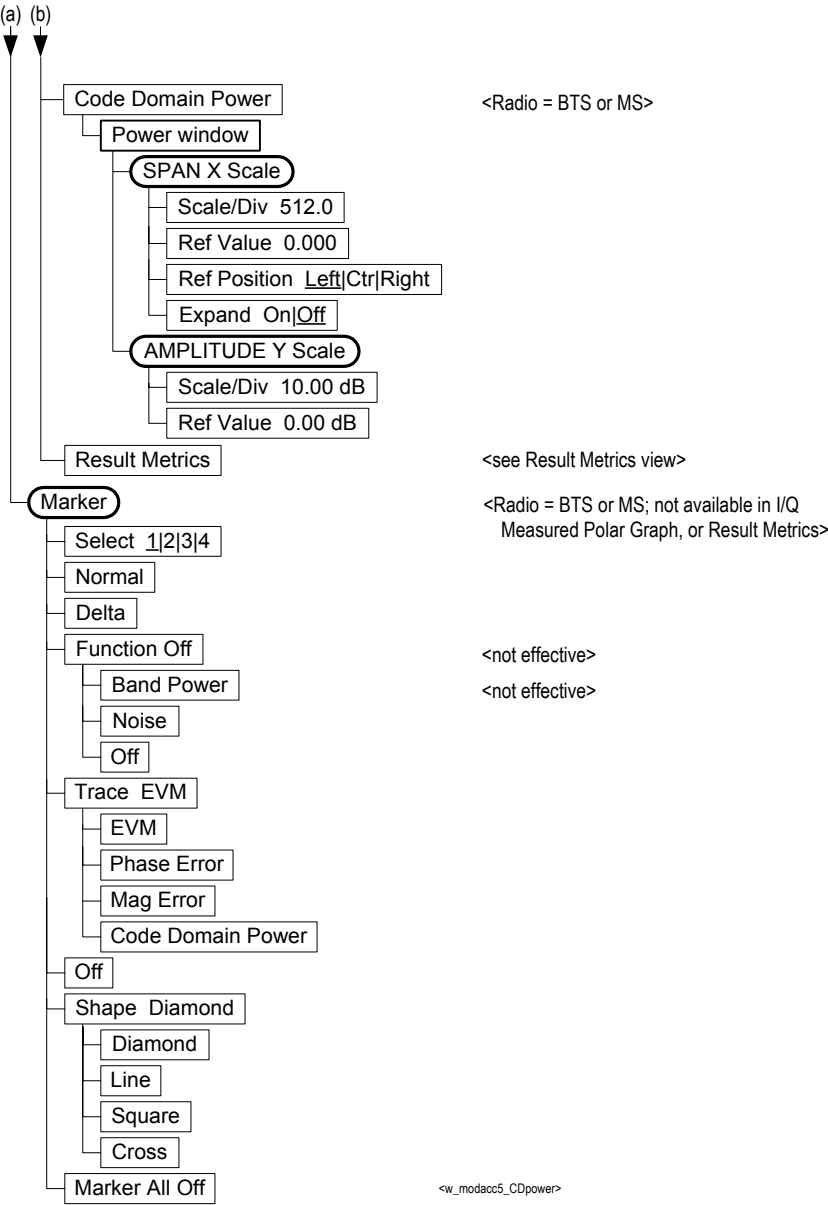


Figure 5-26 QPSK EVM Measurement Key Flow (1 of 2)

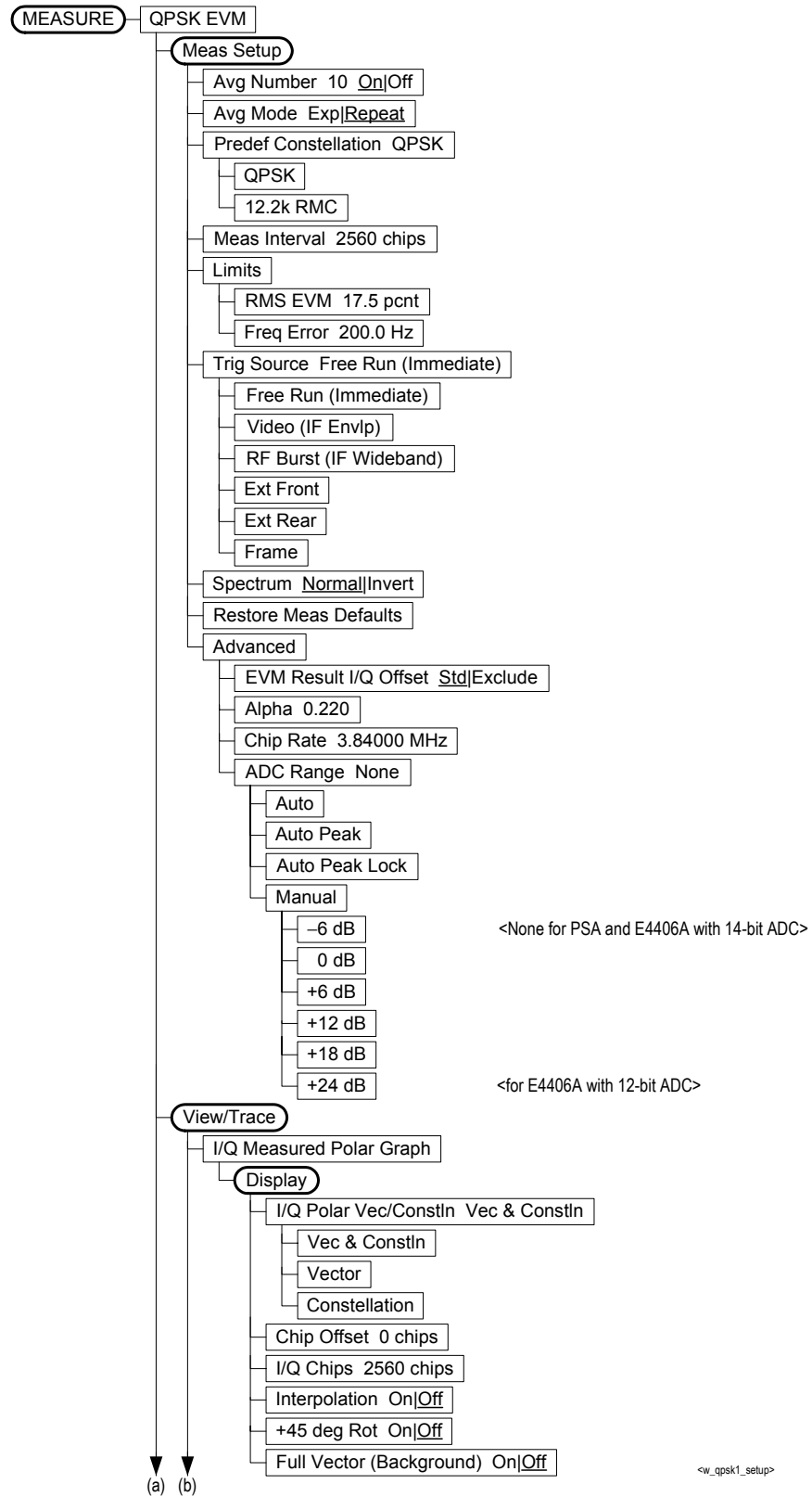
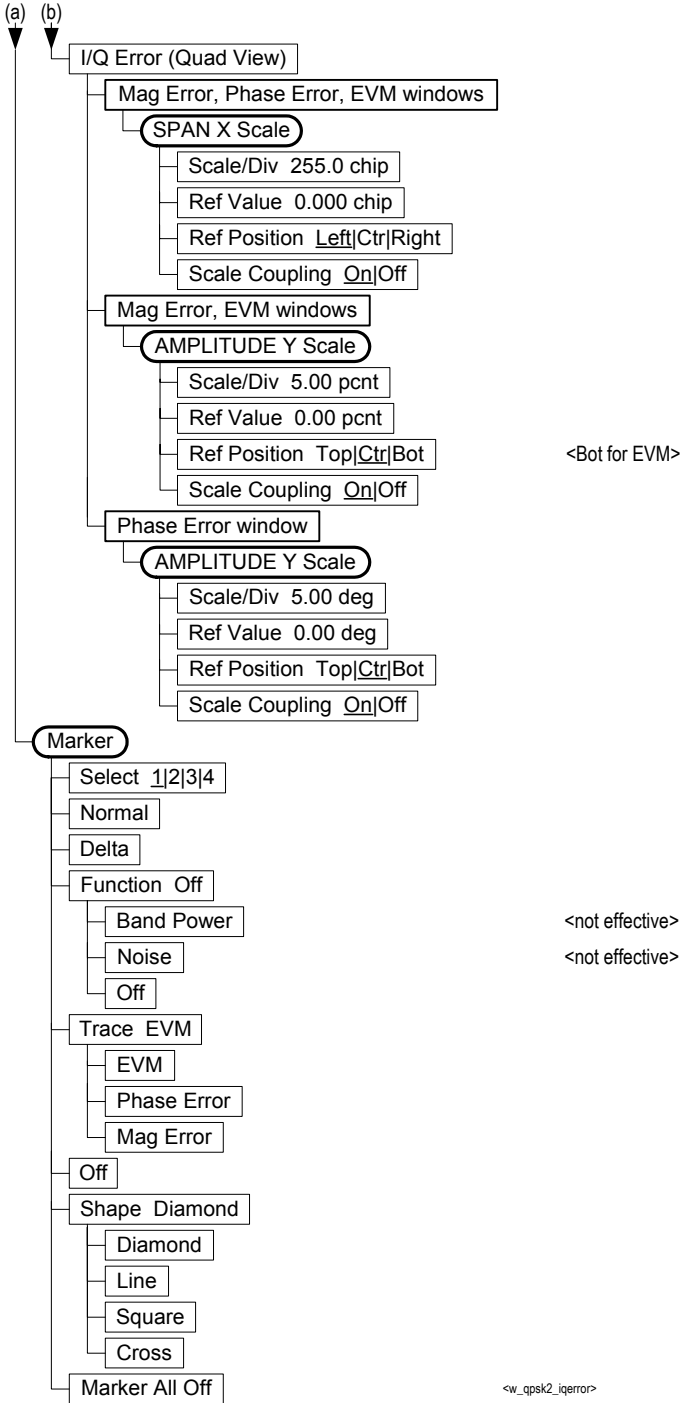


Figure 5-27 QPSK EVM Measurement Key Flow (2 of 2)



Menu Maps

Figure 5-28 Power Stat CCDF Measurement Key Flow

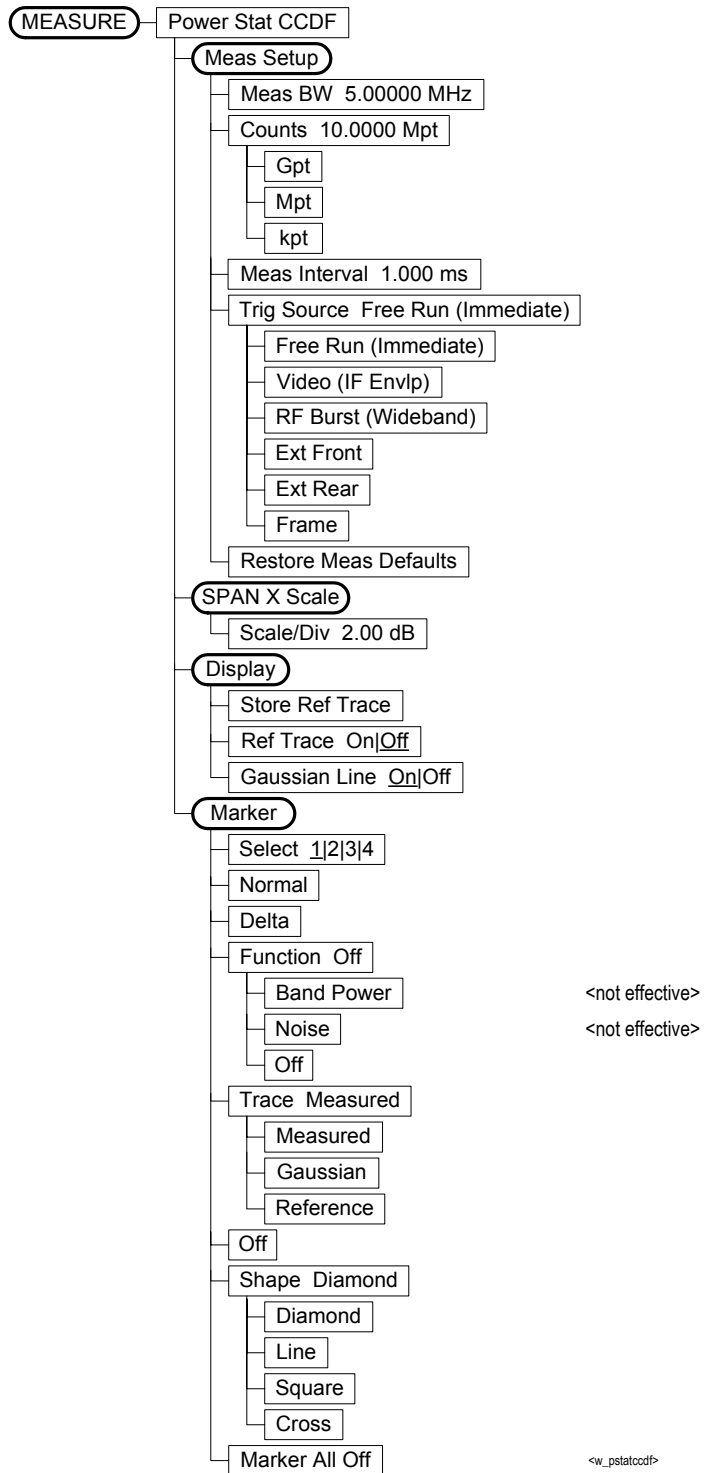
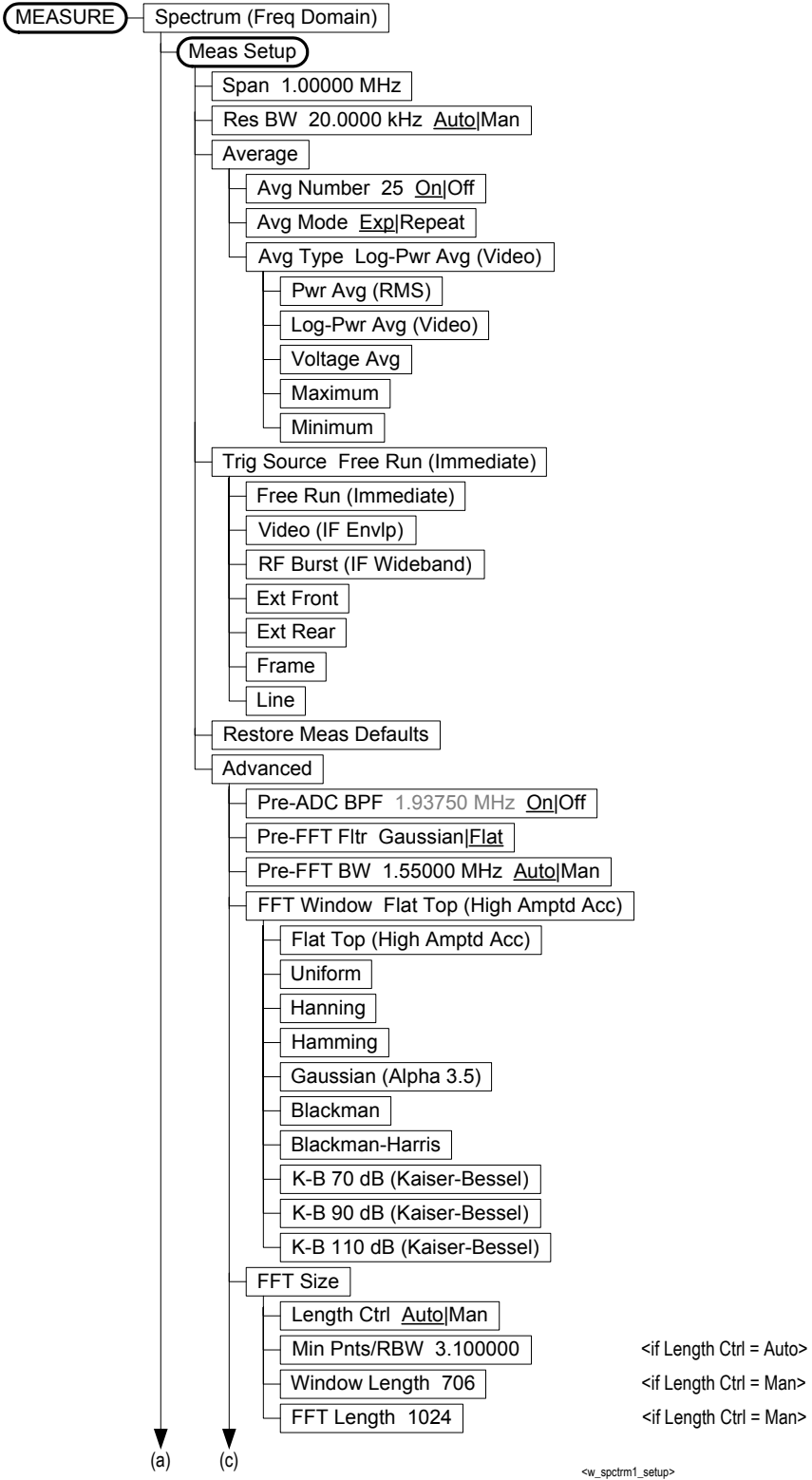


Figure 5-29 Spectrum (Freq Domain) Measurement Key Flow (1 of 4)



Menu Maps

Figure 5-30 Spectrum (Freq Domain) Measurement Key Flow (2 of 4)

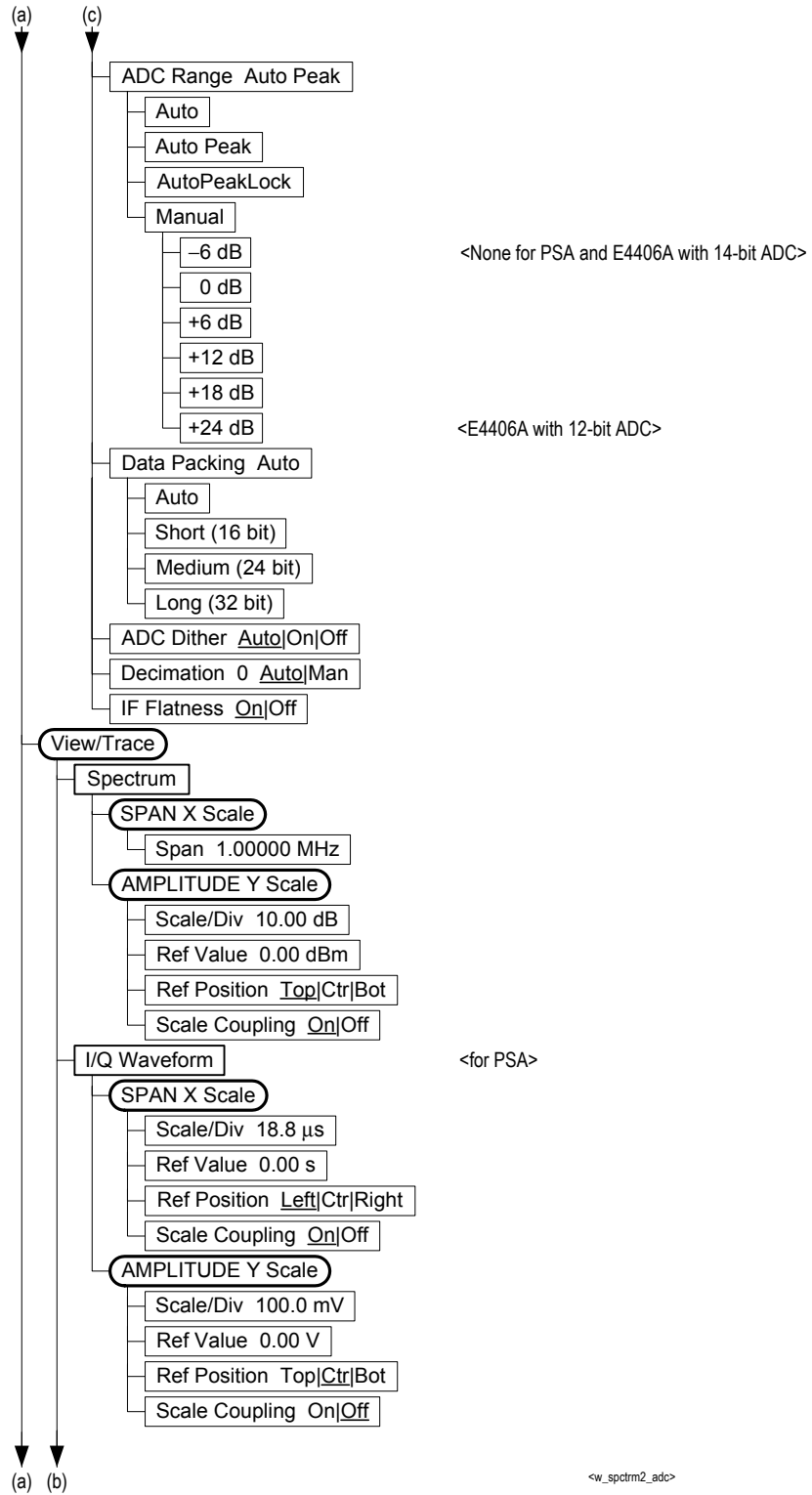


Figure 5-31 Spectrum (Freq Domain) Measurement Key Flow (3 of 4)

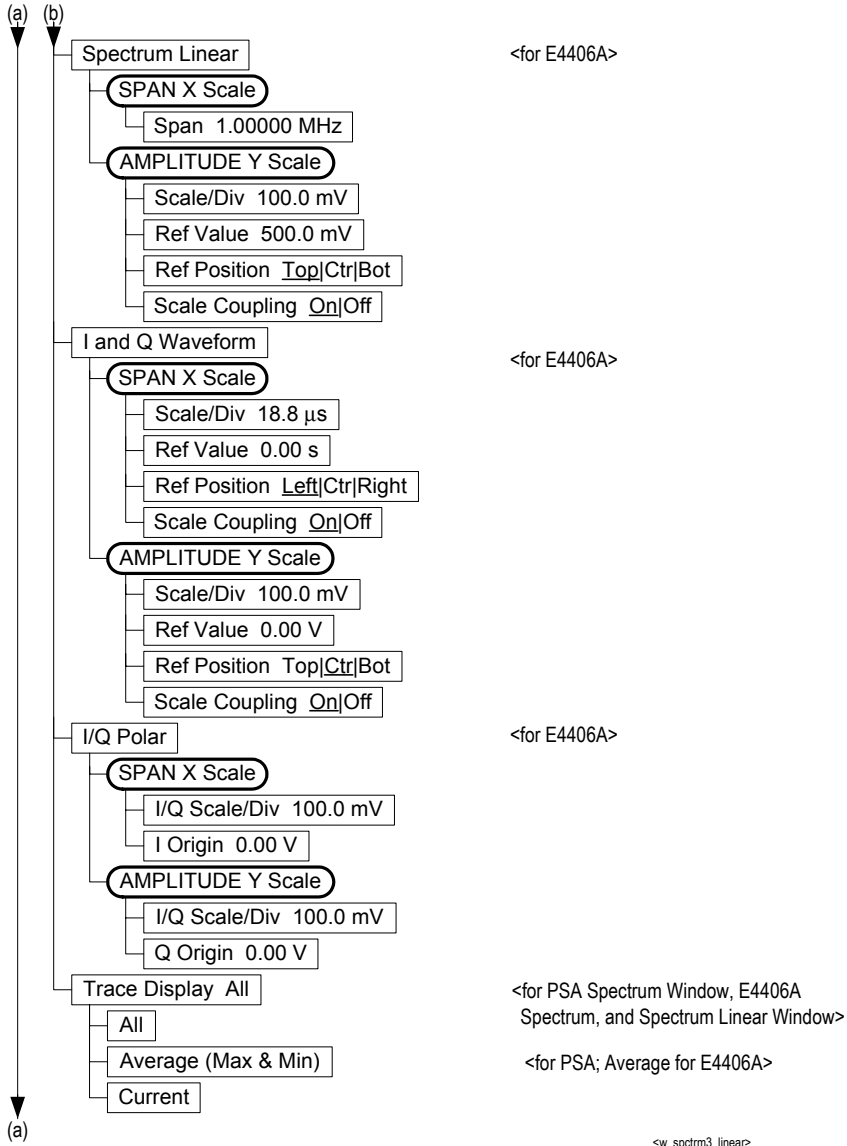


Figure 5-32 Spectrum (Freq Domain) Measurement Key Flow (4 of 4)

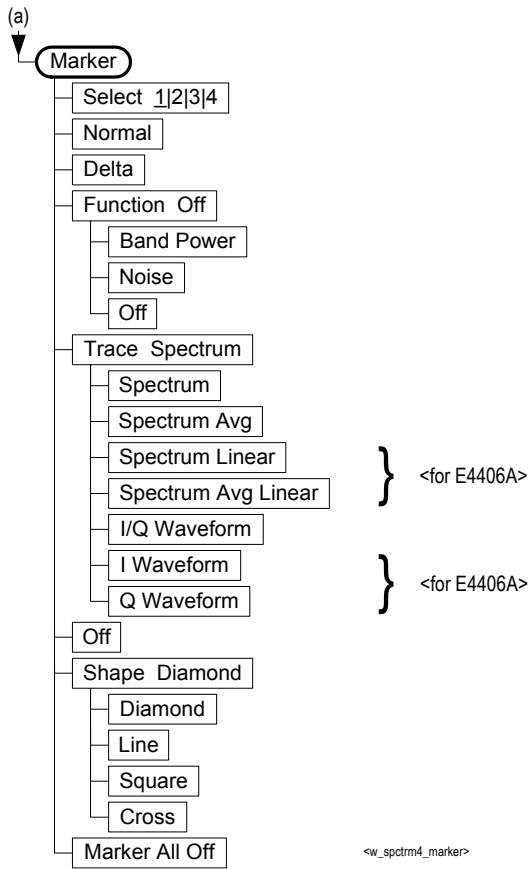
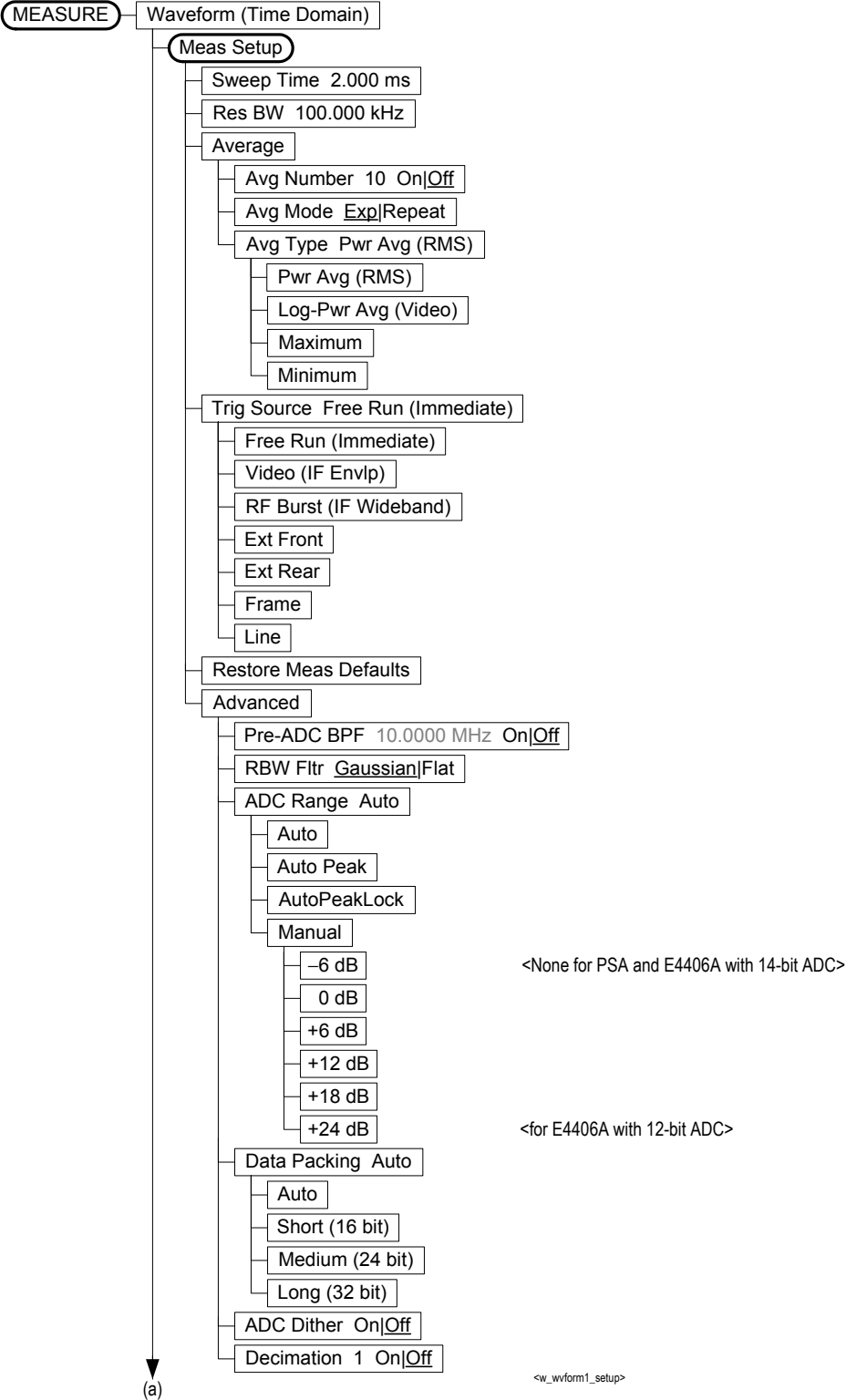


Figure 5-33 Waveform (Time Domain) Measurement Key Flow (1 of 3)



Menu Maps

Figure 5-34 Waveform (Time Domain) Measurement Key Flow (2 of 3)

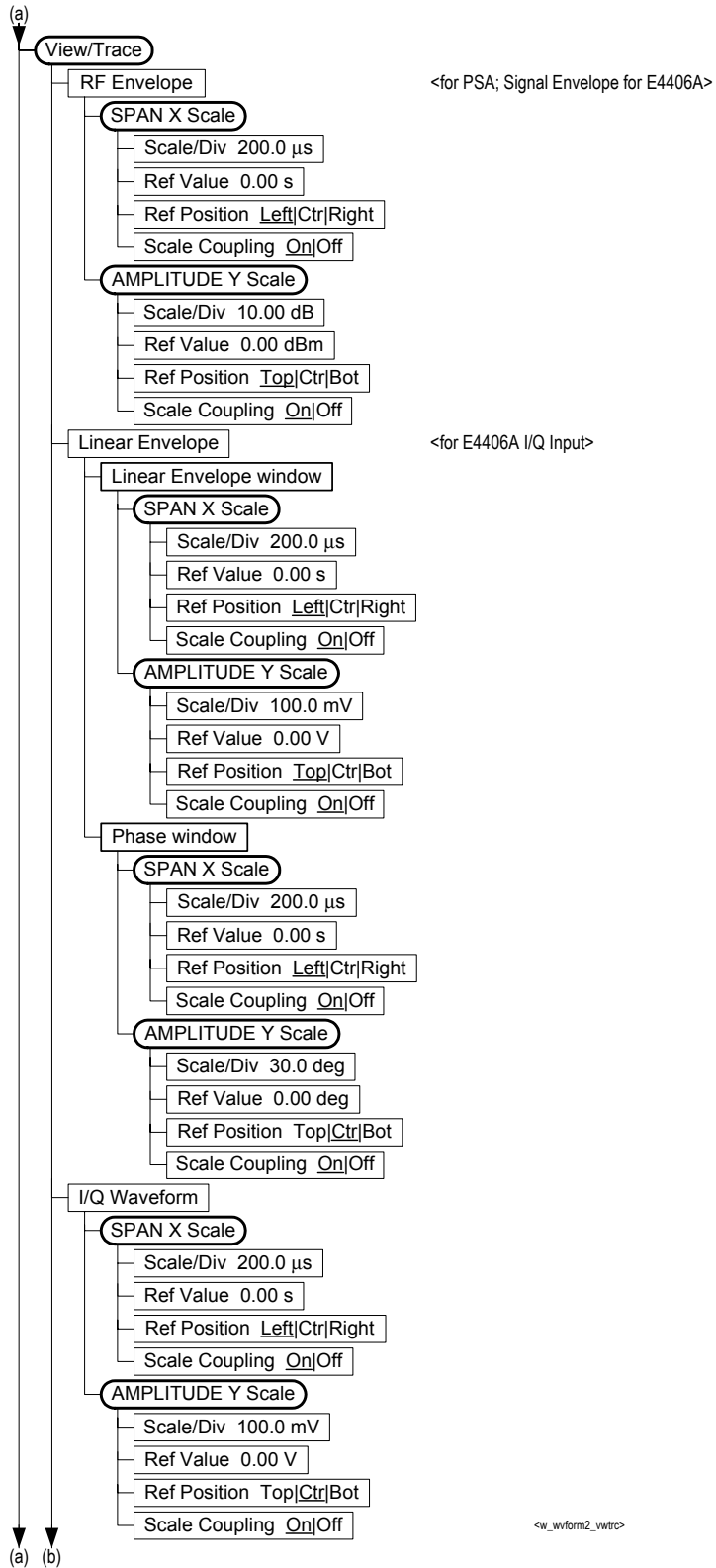
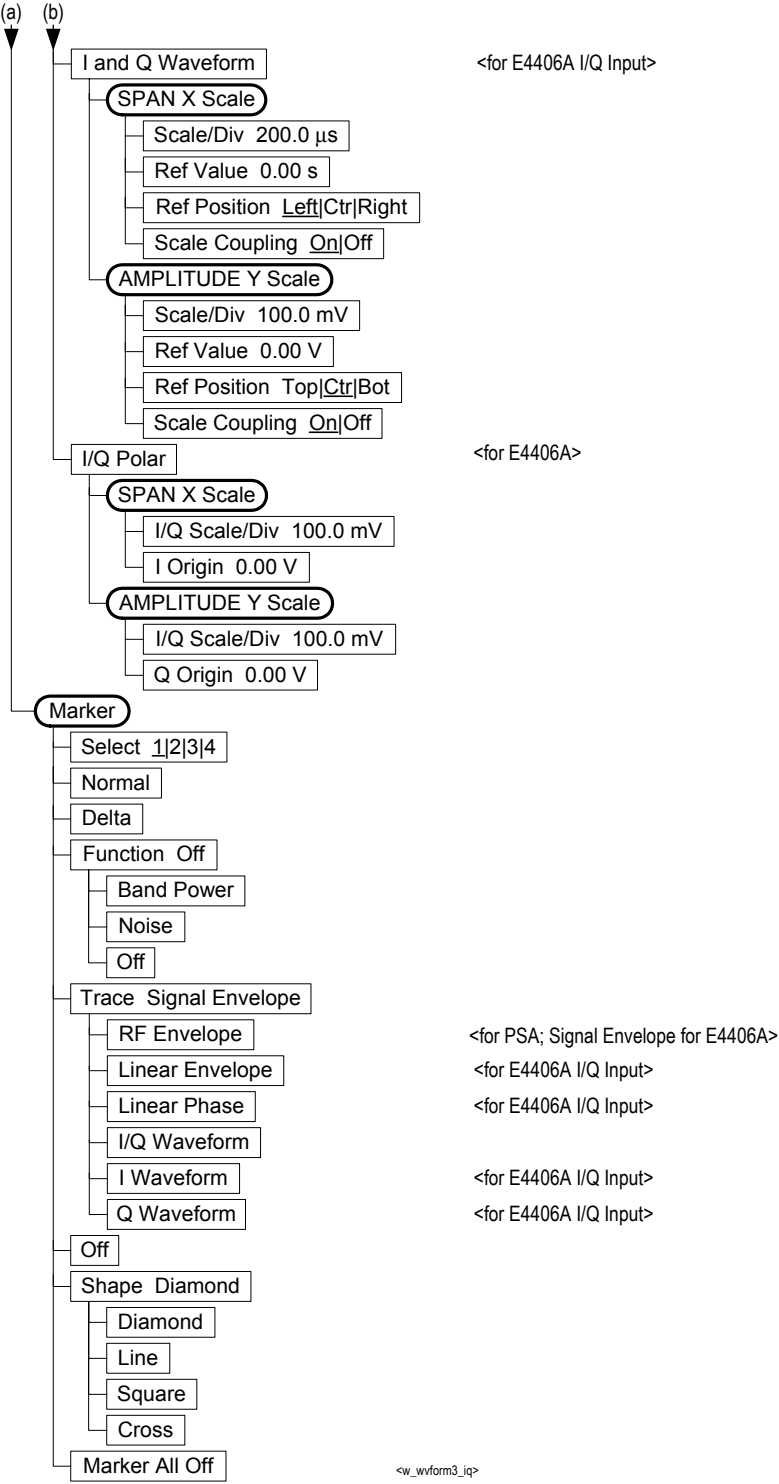


Figure 5-35 Waveform (Time Domain) Measurement Key Flow (3 of 3)



Menu Maps

Figure 5-36 Power vs. Time Measurement Key Flow (1 of 2)

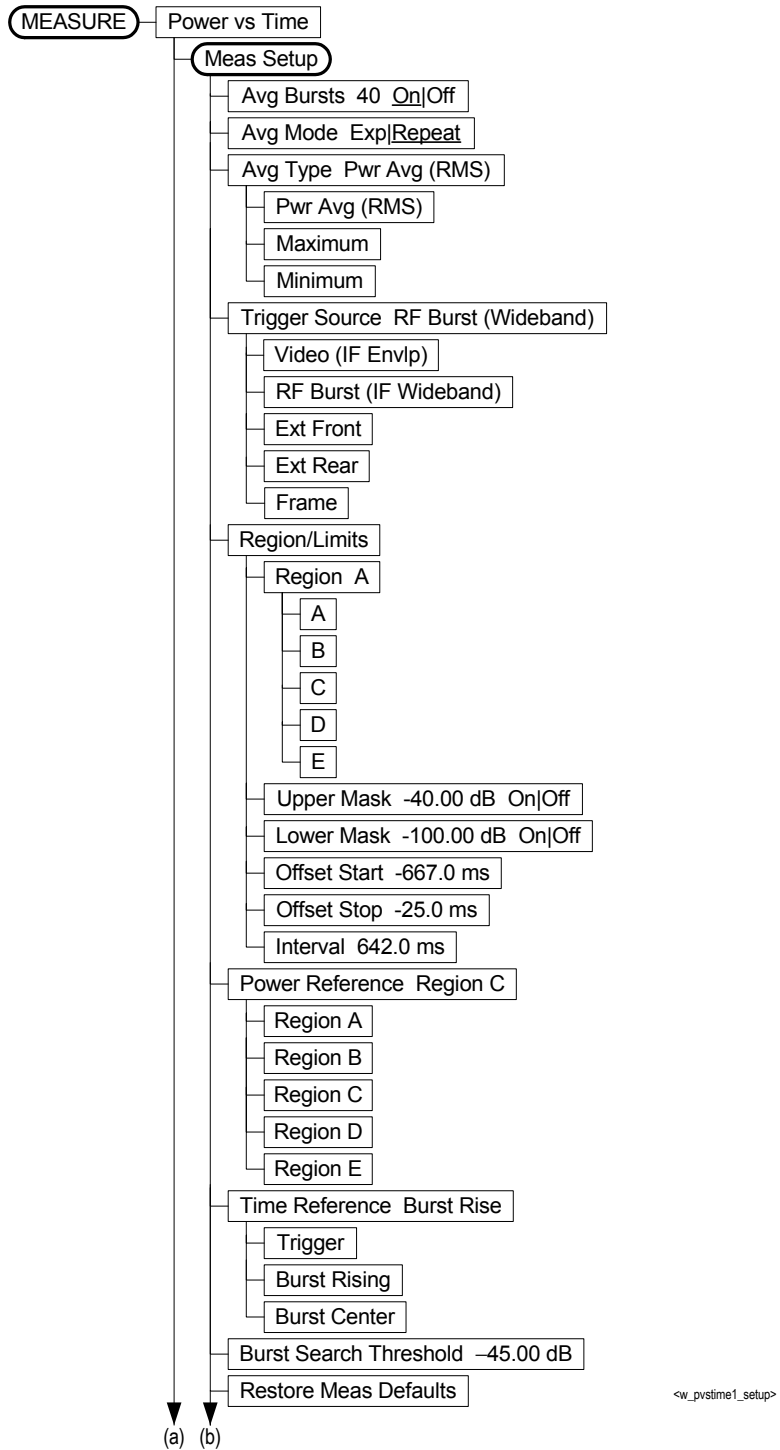
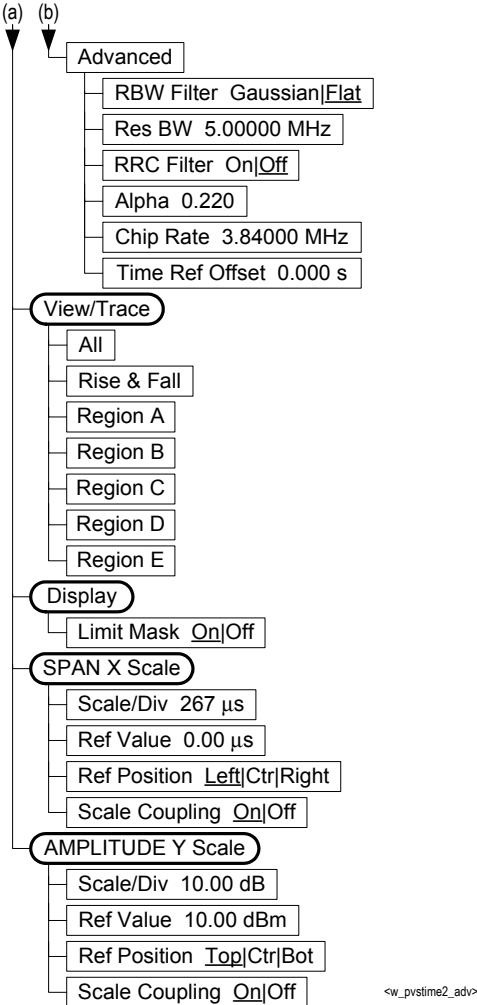


Figure 5-37 Power vs. Time Measurement Key Flow (2 of 2)



Menu Maps

Figure 5-38 Power Control Measurement Key Flow (1 of 2)

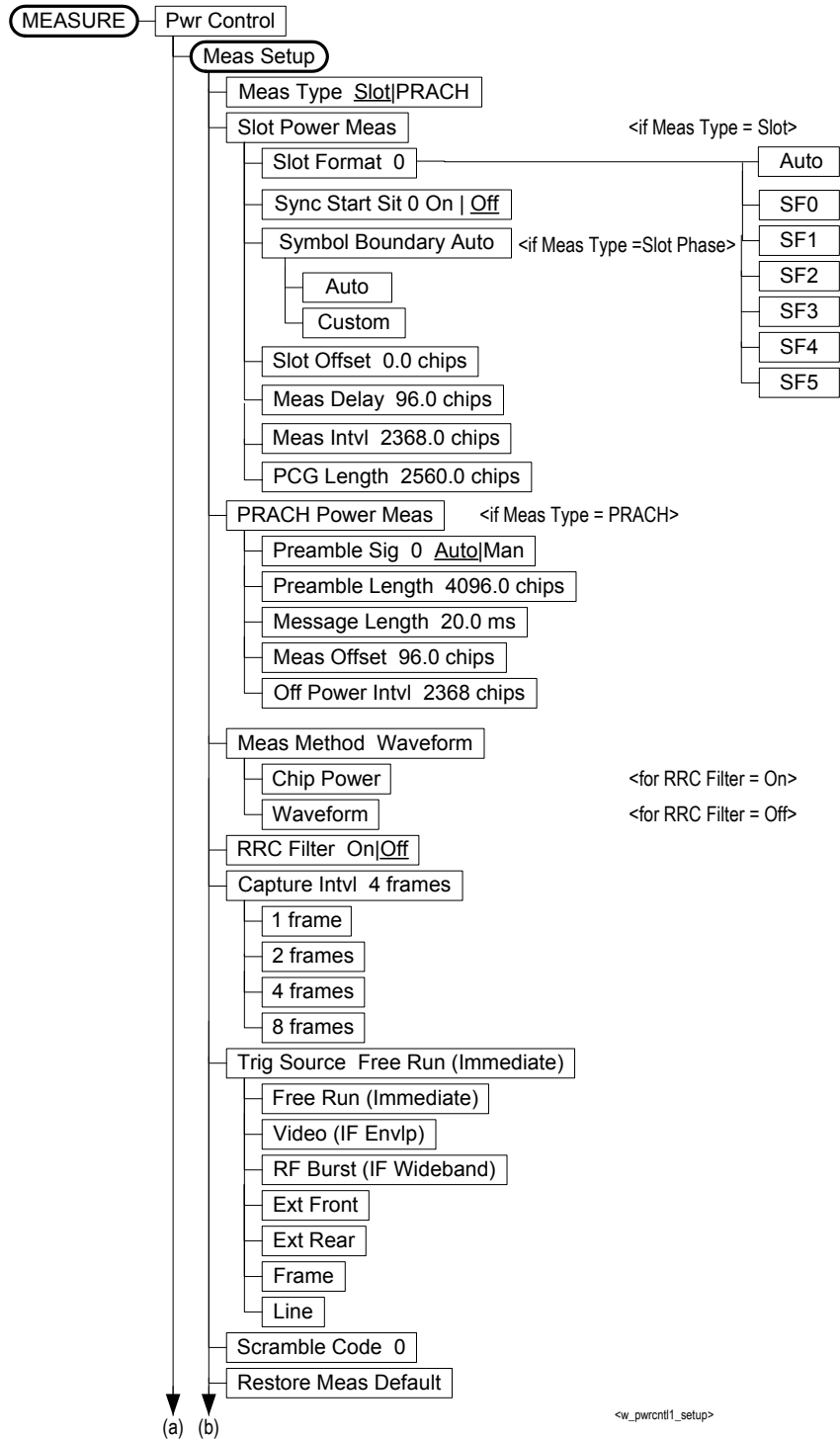
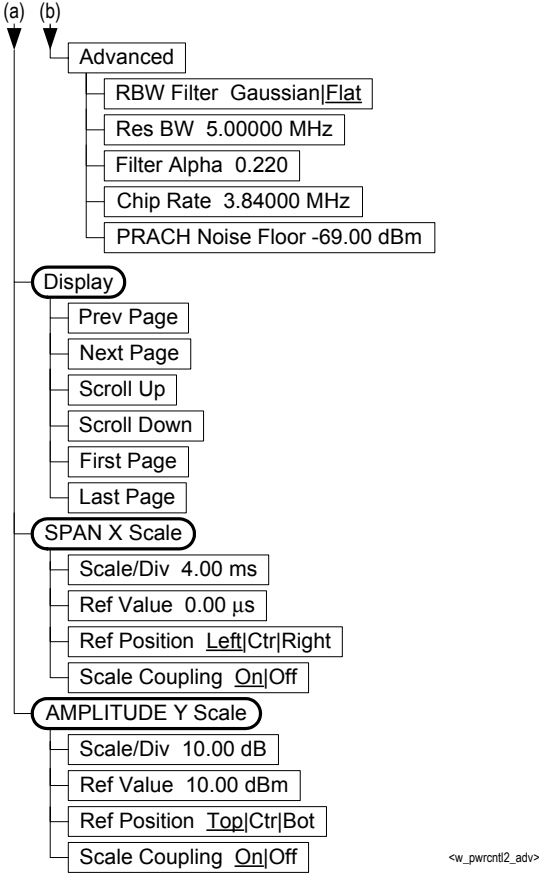


Figure 5-39 Power Control Measurement Key Flow (2 of 2)



6

Programming Commands

These commands are only available when the W-CDMA (3GPP) mode has been selected using `INSTRument:SElect WCDMA`. If this mode is selected, commands that are unique to another mode are not available.

SCPI Command Subsystems

- “CALCulate Subsystem” on page 562
- “CONFigure Subsystem” on page 619
- “DISPlay Subsystem” on page 620
- “FETCh Subsystem” on page 645
- “FORMat Subsystem” on page 646
- “INITiate Subsystem” on page 648
- “INSTrument Subsystem” on page 650
- “MEASure Group of Commands” on page 654
- “READ Subsystem” on page 757
- “SENSe Subsystem” on page 758
- “TRIGger Subsystem” on page 1050

Programming Command Compatibility Across Model Numbers and Across Modes

Across PSA Modes: Command Subsystem Similarities

When you select different modes you get different sets of available programming commands. That is, *only* the commands that are appropriate for the current mode are available. Also, some commands have the same syntax in different modes but have different ranges or settings that are only appropriate to the current mode.

The following table shows which command subsystems are the same across different modes. If there is no “X” by a particular subsystem, then the set of available commands is different in those modes. Command ranges or defaults may also be different. Refer to the programming command descriptions in the documentation for each mode for details.

Command Subsystem	Same command set is available:	Same command set is available:
	SA mode compared with the application modes: Digital Modulation, Basic, WLAN, W-CDMA, cdmaOne, cdma2000, 1xEV-DO, GSM, EDGE, NADC, PDC, or Measuring Receiver	SA mode compared with the application modes: Phase Noise, Noise Figure, TD-SCDMA
IEEE common commands	X	X
ABORt	X	X
CALCulate		
CALibration	X	X
CONFigure		
COUPle	not available in these application modes	not available in these application modes
DISPlay		
FETCh		
FORMat		X
HCOPy	X	X
INITiate		

Command Subsystem	Same command set is available: SA mode compared with the application modes: Digital Modulation, Basic, WLAN, W-CDMA, cdmaOne, cdma2000, 1xEV-DO, GSM, EDGE, NADC, PDC, or Measuring Receiver	Same command set is available: SA mode compared with the application modes: Phase Noise, Noise Figure, TD-SCDMA
INPut	not available in these application modes	X
MEASure		
MEMory	X	X
MMEMory	X	X
MMEMory:STORe:TRACe	not available in these application modes	X
READ		
[SENSe] [SENSe:]CHANnel [SENSe:]CORRection [SENSe:]FEED [SENSe:]FREQuency:CE NTer [SENSe:]FREQuency:<other subsystems> [SENSe:]<measurement> [SENSe:]POWer [SENSe:]RADio [SENSe:]SYNC	X not available in these application modes	not available in these application modes
STATus	X	X
SYSTem	X	X
TRACe	not available in these application modes	X
TRIGger		
UNIT	X	X

Across PSA Modes: Specific Command Differences

Some programming commands operate differently depending on which Mode the analyzer is set to.

Command	Spectrum Analysis, Phase Noise and Noise Figure Mode	Basic, cdmaOne, cdma2000, 1xEV-DO, W-CDMA, GSM, EDGE, NADC, PDC Modes
CONFigure: <measurement>	Accesses the measurement and sets the instrument settings to the defaults. Averaging is turned on and set to 10. The instrument is put in single measurement mode. It does not initiate a measurement. Use INIT:IMM to make one measurement.	Accesses the measurement and sets the instrument settings to the defaults. If you were already in single measurement mode, it takes one measurement and then waits. If you were in continuous measurement mode it continues to measure.
*ESE default	Default is 255 which means that every error/status bit change that has occurred will be returned with a *ESR? query. You must set the value of *ESE to choose only the bits/status that you want returned.	Default is 0 which means that none of the error/status bit changes that have occurred will be returned with a *ESR? query. You must set the value of *ESE to choose the bits/status that you want returned.
TRIGger commands	For these modes, only one trigger source can be selected and it will be common across the modes. Also, only one value can be set for the trigger delay, level, or polarity.	For these modes, a unique trigger source can be selected for each mode. Also, each trigger source can have unique settings for the its delay, level, and polarity.
Saving and recalling traces	Traces can only be saved when in the Spectrum Analysis mode (MMEM:STOR:TRAC). This is because the instrument state must be saved along with the trace data and the state data varies depending on the number of modes currently available in the instrument.	

Using Applications in PSA Series vs. VSA E4406A

NOTE

This information *only* applies to the application modes: Basic, cdmaOne, cdma2000, 1xEV-DO, W-CDMA, GSM, EDGE, NADC, and PDC.

Command	PSA Series	VSA E4406A: A.04.00	VSA E4406A: A.05.00
*RST	Resets instrument, putting it in continuous measurement mode. Use INIT:CONT OFF to select single measurement mode and INIT:IMM to start one measurement.	Resets instrument, putting it in single measurement mode. One measurement is initiated when the command is sent.	Resets instrument, putting it in single measurement mode. No measurement is initiated when the command is sent. Use INIT:IMM to start one measurement.
CONFigure: <measurement>	Accesses the measurement and sets the instrument settings to the defaults. If you were already in single measurement mode, it takes one measurement and then waits.	Same as PSA. Accesses the measurement and sets the instrument settings to the defaults. If you were already in single measurement mode, it takes one measurement and then waits.	Accesses the measurement and sets the instrument settings to the defaults. If you were already in single measurement mode, it does not initiate a measurement. Use INIT:IMM to make one measurement.
*ESE default	Default is 255 which means that every error/status bit change that has occurred will be returned with a *ESR? query. You must set the value of *ESE to choose only the bits/status that you want returned.	Default is 0 which means that none of the error/status bit changes that have occurred will be returned with a *ESR? query. You must set the value of *ESE to choose the bits/status that you want returned.	Same as VSA A.04.00. Default is 0 which means that none of the error/status bit changes that have occurred will be returned with a *ESR? query. You must set the value of *ESE to choose the bits/status that you want returned.
*LRN	The command is <i>not</i> available.	The command is available.	The command is available.

Command	PSA Series	VSA E4406A: A.04.00	VSA E4406A: A.05.00
TRIGger commands	<p>In Spectrum Analysis mode only one value can be set for the trigger's source, delay, level, or polarity.</p> <p>Basic, GSM, EDGE, cdmaOne, cdma2000, W-CDMA, NADC, PDC modes function the same as VSA</p>	<p>You can select a unique trigger source for each mode. Each trigger source can have unique settings for the its delay, level, and polarity.</p>	<p>Same as VSA A.04.00.</p> <p>You can select a unique trigger source for each mode. Each trigger source can have unique settings for the its delay, level, and polarity.</p>
AUTO ON OFF control and setting manual values	<p>We recommend that you set a function's automatic state to OFF, before you send it your manual value.</p> <p>Some functions will turn off the automatic mode when you send a specific manual value, but others will not. This also varies with the instrument model.</p>	<p>We recommend that you set a function's automatic state to OFF, before you send it your manual value.</p> <p>Some functions will turn off the automatic mode when you send a specific manual value, but others will not. This also varies with the instrument model.</p>	<p>We recommend that you set a function's automatic state to OFF, before you send it your manual value.</p> <p>Some functions will turn off the automatic mode when you send a specific manual value, but others will not. This also varies with the instrument model.</p>

CALCulate Subsystem

This subsystem is used to perform post-acquisition data processing. In effect, the collection of new data triggers the CALCulate subsystem. In this instrument, the primary functions in this subsystem are markers and limits.

The SCPI default for data output format is ASCII. The format can be changed to binary with FORMat:DATA which transports faster over the bus.

Code Domain Power - Limits

Code Domain—Active Set Threshold

```
:CALCulate:CDPower:ASET:THReshold <numeric>
```

```
:CALCulate:CDPower:ASET:THReshold?
```

Set the threshold level for the active channel identification function.

Factory Preset: 0.0 dBm

Range: -100.0 to 0.0 dB

Remarks: You must be in the cdma2000, W-CDMA, or 1xEV-DO mode to use this command. Use INSTRument:SElect to set the mode.

Code Domain—Active Set Threshold Mode

```
CALCulate:CDPower:ASET:THReshold:AUTO OFF | ON | 0 | 1
```

```
CALCulate:CDPower:ASET:THReshold:AUTO?
```

Allows you to toggle the active channel identification function between Auto and Man. If set to Auto, the active channels are determined automatically by the internal algorithm. If set to Man, the active channel identification is determined by a user definable threshold ranging from 0.00 to -100.0 dB.

Turn the automatic mode On or Off, for the active channel identification function.

OFF – The active channel identification for each code channel is determined by a value set by CALCulate:CDPower:ASET:THReshold.

ON – The active channels are determined automatically with the internal algorithm.

Notes	This command is effective when Symbol Boundary BTS is set to AUTO. (For MS, this command is always effective.)
Remote Command Notes	Turn the automatic mode On or Off, for the active channel identification function. OFF – The active channel identification for each code channel is determined by a value set by CALCulate:CDPower:ASET:THReshold. ON – The internal algorithm determines the active channels automatically.
Preset	0.0, , ON
State Saved	Saved in instrument state.
SCPI Resolution	0.01
Key Path	Meas Setup, More, More, Advanced
Remarks:	You must be in the cdma2000, W-CDMA, or 1xEV-DO mode to use this command. Use INSTRument:SElect to set the mode.

Code Domain—I/Q Branch (MS)

```
:CALCulate:CDPower:AXIS[:MS] IPH|QPH|IQCombined
:CALCulate:CDPower:AXIS[:MS] ?
```

Example	:CALCulate:CDPower:AXIS:MS IPH
Notes	IPH – I Phase QPH – Q Phase IQC – Combined I and Q Phase This command is effective when [:SENSe]:RADio:DEVICE is set to MS. (This menu label is grayed out when [:SENSe]:RADio:DEVICE is set to BTS.)
Preset	QPH
State Saved	Saved in instrument state.
Range	I Q IQ Combined
Key Path	Meas Setup

Code Domain—Data Bit Format

```
:CALCulate:CDPower:DBITs[:FORMat] BINary|TRISate  
:CALCulate:CDPower:DBITs[:FORMat]?
```

Set DBITs (Demod Bit) data representation format to Binary or Tri-state.

Factory Preset: BINary

Remarks: You must be in the W-CDMA mode to use this command. Use INSTRument:SELEct to set the mode.

Code Domain—DTX/Burst Detect

```
:CALCulate:CDPower:DTXBurst 0|1|OFF|ON  
:CALCulate:CDPower:DTXBurst?
```

For downlink signals, allows you the detection of the power burst, for either “CM”(Compressed Mode) or “DTX”. In case of “Compressed Mode”, the both I and Q symbol power is off. And, in case of “DTX” one of “I” or “Q” symbol power (or both) can be off. For uplink signals, allows you the detection of HS-DPCCH burst which sub-frame does not align with DPCCH slot boundary.

Example	:CALCulate:CDPower:DTXB ON
Notes	If HSDPA/HSUPA option is enabled, this parameter is active and effective for both uplink and downlink. If HSDPA/HSUPA option is disabled, this parameter is active and effective only for downlink.
Preset	OFF
State Saved	Saved in instrument state.
Key Path	Meas Setup, More, More, Symbol Analysis

Code Domain—Tx Diversity I/Q Axis Rotation

```
:CALCulate:CDPower:IQPhase:ROtation <real>
:CALCulate:CDPower:IQPhase:ROtation?
```

Allows you to set the rotation of the I/Q Axis.

Notes	Input value is calculated by modulo of 360 so that its range is: -180 < Input-Value <= 180 And, then input value is rounded to the nearest value in the followings. 0 +45 +90 +135 +180 -135 -90 -45
Preset	0
State Saved	Saved in instrument state.
Range	0 +45 +90 +135 +180 -135 -90 -45
Key Path	Meas Setup, More, More, Symbol Analysis

Code Domain—Marker to trace

```
:CALCulate:CDPower:MARKer:TRACe CDPower | EVM | MERRor | PERRor
| SPOWer | CPOWer | CDError
:CALCulate:CDPower:MARKer:TRACe?
```

Setup	:CONF:CDP
Dependencies and Couplings	No
Preset	CDPower
State Saved	Saved in instrument state.
Range	CDPower EVM MERRor PERRor SPOWer CPOWer
Key Path	Marker, Trace

Code Domain—Mod Scheme [BTS only]

```
:CALCulate:CDPower:MTYPE AUTO|QPSK|QAM16
```

```
:CALCulate:CDPower:MTYPE?
```

If Radio Device is BTS AND Symbol Rate is 240 ksps, Mod Scheme softkey is displayed and active.

If Radio Device is BTS AND Symbol Rate is NOT 240 ksps, Mod Scheme softkey is displayed but inactive (grayed out). In this case, the last setting (Auto/QPSK/16QAM) for 240 ksps is kept being displayed on the softkey even though “QPSK” setting is always used.

If Radio Device is MS, Mod Scheme softkey is not displayed. Instead, I/Q Branch softkey is displayed and active.

Auto: The specified channel by Symbol Rate and Code Number is considered to be modulated by auto-detected scheme.

QPSK: The specified channel by Symbol Rate and Code Number is considered to be modulated by QPSK.

16QAM: The specified channel by Symbol Rate and Code Number is considered to be modulated by 16QAM.

Example :CALCulate:CDPower:MTYPE QAM16

Notes W-CDMA HSDPA/HSUPA option license is necessary to make this parameter available. In addition, you need to enable W-CDMA HSDPA/HSUPA option functionality. Otherwise, this parameter is not available --- Modulation Scheme softkey is inactive (grayed out) and SCPI commands for Modulation Scheme do not have effect.

Dependencies and Couplings The softkey is active if Radio Device selection is “BTS” AND Symbol Rate is 240 ksps.

This softkey is inactive (grayed out) if Radio Device selection is “BTS” AND Symbol Rate is NOT 240 ksps. In this case, the last setting is displayed on the softkey even though “QPSK” is always used.

This softkey is not displayed if Radio Device selection is “MS”.

Remote Command
Notes

Note 1: The reason that the SCPI command mnemonic is “:CALCulate:CDPower:MTYPE”, not “:CALCulate:CDPower:TYPE”:

1xEV-DO was the first personality that employed modulation type selection. It is natural for W-CDMA to use the same mnemonic as much as possible for consistency.

1xEV-DO used “TYPE” to select modulation type. However, modulation type is not the only one attribute (type) of a channel. Other attributes could be introduced later on either by standard update or by customer requirement. To accommodate the possible new attributes, “M” is added at the beginning of “TYPE”, which means “Modulation”.

Note 2: The reason that enumeration for 16QAM is “QAM16”, not “QAM” or “16QAM”:

1xEV-DO used “QAM” to represent 16QAM, but the “QAM” would be ambiguous if other types of QAM such as 64QAM are introduced. Also, “16QAM” violates SCPI syntax. Therefore, “QAM16” is the best choice.

Note 3:

You must be in W-CDMA mode to use this command. Use :INSTRument:SElect to set the mode.

Preset	AUTO
State Saved	Saved in instrument state.
Range	AUTO QPSK QAM16
Key Path	Meas Setup

Code Domain—Packed Mode

:CALCulate:CDPower:PACKed OFF | PKM1

:CALCulate:CDPower:PACKed?

Allows you to select the packed mode for Demod bits in SCPI result (of READ:CDP12).

OFF : Demod Bits are not packed. (1.0:“1”, 0.0:“0”, -1.0:“X”)

Mode1 : Demod Bits per symbol is packed into 1 float value in bit-slice manner as following.

16QAM(No DTX):Float value 0.....0X3X2X1X0 (X3:I1, X2:Q1, X1:I2, X0:Q2)

QPSK(With DTX): Float value 0.....0M1M0B1B0

NOTE

- The meaning of each bit is : M1:Mask for B1 (1:DTX, 0:Normal), M0:Mask for B0, and B1:I, B0:Q)
 - Packed Mode is only available as a SCPI command. Changing Packed Mode does not change the results of the front-panel display. It only controls the result format of READ(MEAS/FETCH/CONF):CDP12.
-

Example	:CALCulate:CDPower:PACKed PKM1
Dependencies and Couplings	No
Preset	OFF
State Saved	Saved in instrument state.
Range	OFF PKM1

Code Domain -Composite Symbol Boundary

`:CALCulate:CDPower:SBOundary:COMPOSITE OFF|ON|0|1`

`:CALCulate:CDPower:SBOundary:COMPOSITE?`

Turn the composite code channel display function on or off.

The functions of Composite Symbol Boundary for Power Bar Graph and CDE Graph are coupled.

Example	<code>:CALCulate:CDPower:SBOundary:COMPOSITE ON</code>
Notes	Only valid for CDPower Bar Graph window and CDE Graph window. Toggle on the soft key 'On Off'.
Dependencies and Couplings	This command is effective only when the <code>[[:SENSE]:CDPower:CAPTURE:TIME(Capture Interval)</code> is set to 0.067, 1.0, 2.0 and 3.0. Set this parameter Off activate the soft key (Display Symbol Rate).
Preset	ON
State Saved	Saved in instrument state.
Range	On Off
Key Path	Display

Code Domain— Display Symbol Rate

`:CALCulate:CDPower:SBOundary:SRATe <integer>`

`:CALCulate:CDPower:SBOundary:SRATe?`

Set the display symbol rate to read the total power level of the combined code channels defined by the `:CALCulate:CDPower:SRATe` command.

The function of Display Symbol Rate for Power Bar Graph and CDE Graph is coupled each other.

Example	<code>:CALCulate:CDPower:SRATe 30000</code>
Notes	1920000 choice for MS is available only if HSDPA/HSUPA is enabled.
Preset	15000
State Saved	Saved in instrument state.
Range	7500 15000 30000 60000 120000 240000 480000 960000 for BTS 15000 30000 60000 120000 240000 480000 960000 1920000 for MS
Key Path	Meas Setup
Front-panel Unit/Terminator Keys	sps ksps

Code Domain—Symbol EVM Frequency Compensation

`:CALCulate:CDPower:SEVM:FCOMpen ON|OFF|1 0`

`:CALCulate:CDPower:SEVM:FCOMpen?`

Allows you to toggle the setting of the frequency compensation to calculate the symbol EVM.

Example	<code>:CALCulate:CDPower:SEVM:FCOMpen ON</code>
Preset	ON
State Saved	Saved in instrument state.
Key Path	Meas Setup, More, More, Advanced, More

Code Domain—Symbol EVM Phase Compensation

```
:CALCulate:CDPower:SEVM:PCOMpen ON|OFF|1|0
:CALCulate:CDPower:SEVM:PCOMpen?
```

Allows you to toggle the setting of the phase compensation to calculate the symbol EVM.

Example	:CALCulate:CDPower:SEVM:PCOMpen ON
Preset	ON
State Saved	Saved in instrument state.
Key Path	Meas Setup, More, More, Advanced, More

Code Domain—Code Number

```
:CALCulate:CDPower:SPRead <integer>
:CALCulate:CDPower:SPRead?
```

Set a spread code.

Example	:CALCulate:CDPower:SPRead 1
Notes	Max depends on the symbolRate as followings: 511, when CALCulate:CDPower:SRATe=7500 255, when CALCulate:CDPower:SRATe=15000 127, when CALCulate:CDPower:SRATe=30000 63, when CALCulate:CDPower:SRATe=60000 31, when CALCulate:CDPower:SRATe=120000 15, when CALCulate:CDPower:SRATe=240000 7, when CALCulate:CDPower:SRATe=480000 3, when CALCulate:CDPower:SRATe=960000 1, when CALCulate:CDPower:SRATe=1920000
Preset	0
State Saved	Saved in instrument state.

Range	0 to 511, when CALCulate:CDPower:SRATe=7500 0 to 255, when CALCulate:CDPower:SRATe=15000 0 to 127, when CALCulate:CDPower:SRATe=30000 0 to 63, when CALCulate:CDPower:SRATe=60000 0 to 31, when CALCulate:CDPower:SRATe=120000 0 to 15, when CALCulate:CDPower:SRATe=240000 0 to 7, when CALCulate:CDPower:SRATe=480000 0 to 3, when CALCulate:CDPower:SRATe=960000 0 to 1, when CALCulate:CDPower:SRATe=1920000
SCPI Resolution	1
Key Path	Meas Setup

Code Domain—Symbol Rate

:CALCulate:CDPower:SRATe <integer>

:CALCulate:CDPower:SRATe?

Set a symbol rate.

Example	:CALCulate:CDPower:SRATe 30000
Notes	1920000 choice for MS is available only if HSDPA/HSUPA is enabled.
Preset	15000
State Saved	Saved in instrument state.
Range	7500 15000 30000 60000 120000 240000 480000 960000 for BTS 15000 30000 60000 120000 240000 480000 960000 1920000 for MS
Key Path	Meas Setup, Symbol Rate

Code Domain—SCH Suppression for BTS

```
:CALCulate:CDPower:SSUPpress[:STATE] ON|OFF|1|0
```

```
:CALCulate:CDPower:SSUPpress[:STATE]?
```

Subtracts the primary and secondary SCH power leakage from other code channels during the demodulation process in the instrument. This improves symbol EVM, magnitude error and phase error measurement accuracy. Downlink channels with low coding gain can suffer interference of primary and secondary SCH, because they are not orthogonal with other code channels. To correct this, the P-SCH and S-SCH power are calculated in the estimation (“Best Fitting”) using MMSE, then those values are subtracted from the incoming signal before any other channels are demodulated.

Example	:CALCulate:CDPower:SSUPpress:STATE ON
Notes	No
Dependencies and Couplings	No
Preset	ON
State Saved	Saved in instrument state.
Range	On Off 1 0
Key Path	Meas Setup, More, More, Advanced, More

Code Domain—Sweep Offset (Measurement Offset)

```
:CALCulate:CDPower:SWEep:OFFSet <integer>
```

```
:CALCulate:CDPower:SWEep:OFFSet <time> (1xEV-DO only)
```

```
:CALCulate:CDPower:SWEep:OFFSet?
```

1xEV-DO mode:

Set the timing offset of measurement interval in units of slot (1 slot = 1.667 ms).

The sum of `CALCulate:CDPower:SWEep:TIME` and `CALCulate:CDPower:SWEep:OFFSet` must be equal to or less than `SENSE:CDPower:CAPTURE:TIME`. If the sum becomes more than the value, `CALCulate:CDPower:SWEep:OFFSet` is adjusted automatically.

cdma2000 mode:

Set the timing offset of measurement interval in units of Power Control Group (PCG; 1 PCG = 1.25 ms).

The sum of **CALCulate:CDPower:SWEep:TIME** and **CALCulate:CDPower:SWEep:OFFSet** must be equal to or less than **SENSe:CDPower:CAPTure:TIME**. If the sum becomes more than the value, **CALCulate:CDPower:SWEep:OFFSet** is adjusted automatically.

W-CDMA mode:

Set the timing offset of measurement interval in slots (1 slot = 666.6µs).

The sum of **CALCulate:CDPower:SWEep:TIME** and **CALCulate:CDPower:SWEep:OFFSet** must be equal to or less than **SENSe:CDPower:CAPTure:TIME** × 15. If the sum becomes more than the value, **CALCulate:CDPower:SWEep:OFFSet** is adjusted automatically.

Example	:CALCulate:CDPower:SWEep:OFFSet 2
Dependencies and Couplings	See Remarks
Preset	0
State Saved	Saved in instrument state.
SCPI Resolution	1
Key Path	Meas Setup
Range:	0 to SENSe:CDPower:CAPTure:TIME – 1 for cdma2000 0 to SENSe:CDPower:CAPTure:TIME – 0.5 for 1xEV-DO 0 to SENSe:CDPower:CAPTure:TIME × 15 – 1 for W-CDMA
Remarks:	You must be in the cdma2000, W-CDMA, or 1xEV-DO mode to use this command. Use INSTrument:SElect to set the mode.

Code Domain—Sweep Time (Measurement Interval)

`:CALCulate:CDPower:SWEep:TIME <integer>`

`:CALCulate:CDPower:SWEep:TIME <float>` for (1xEV-DO only)

`:CALCulate:CDPower:SWEep:TIME?`

- For 1xEV-DO

Set the length of measurement interval in units of slot (1 slot = 1.667 ms).

The sum of `CALCulate:CDPower:SWEep:TIME` and `CALCulate:CDPower:SWEep:OFFSet` must be equal to or less than `SENSe:CDPower:CAPTure:TIME`. If the sum becomes more than the value, `CALCulate:CDPower:SWEep:OFFSet` is adjusted automatically.

- For cdma2000

Set the length of measurement interval in the unit of Power Control Group (PCG; 1 PCG = 1.25 ms).

The sum of `CALCulate:CDPower:SWEep:TIME` and `CALCulate:CDPower:SWEep:OFFSet` must be equal to or less than `SENSe:CDPower:CAPTure:TIME`. If the sum becomes more than the value, `CALCulate:CDPower:SWEep:OFFSet` is adjusted automatically.

- For W-CDMA

Set the length of measurement interval in slots (1 slot = 666.6 μ s).

The sum of `CALCulate:CDPower:SWEep:TIME` and `CALCulate:CDPower:SWEep:OFFSet` must be equal to or less than `SENSe:CDPower:CAPTure:TIME` \times 15. If the sum becomes more than the value, `CALCulate:CDPower:SWEep:OFFSet` is adjusted automatically.

Factory Preset: 1

Range: 1 to `SENSe:CDPower:CAPTure:TIME` for cdma2000

0.5 to `SENSe:CDPower:CAPTure:TIME` for 1xEV-DO

1 to `SENSe:CDPower:CAPTure:TIME` \times 15 for W-CDMA

Remarks: You must be in the cdma2000, W-CDMA, or 1xEV-DO mode to use this command. Use `INSTRument:SELEct` to set the mode.

Code Domain—Time Offset for DPCH

`:CALCulate:CDPower:TDPCh <integer>`

`:CALCulate:CDPower:TDPCh?`

Set tDPCH value manually, when `:CALCulate:CDPower:TDPCh:AUTO` is OFF. This value is set at its auto number if Time Offset detection Auto mode is set to ON.

Factory Preset: 0

Range: 0 to 149

Remarks: This setting is used only when `:CALCulate:CDPower:TDPCh:AUTO` is OFF. You must be in the W-CDMA mode to use this command. Use `INSTRument:SELEct` to set the mode.

Code Domain—Time Offset (tHS-DPCCH) MS

`:CALCulate:CDPower:THSDpcch <integer>`

`:CALCulate:CDPower:THSDpcch?`

Uplink HS-DPCCH's slots are not aligned with DPCCH slots. Therefore, to analyze its Symbol EVM and Demod Bits correctly, you need to manually specify slot offset of the HS-DPCCH.

Only manual setting is possible. Auto-detection function is not supported.

Example	<code>:CALCulate:CDPower:THSDpcch 35</code>
Notes	Auto detection of the tHS-DPCCH is not supported.
Preset	0
State Saved	Saved in instrument state.
SCPI Resolution	1
Key Path	Meas Setup, More, More, Symbol Analysis

Code Domain—Time Offset Detection

CALCulate:CDPower:TDPCh <integer>

CALCulate:CDPower:TDPCh?

CALCulate:CDPower:TDPCh:AUTO OFF | ON | 0 | 1

CALCulate:CDPower:TDPCh:AUTO?

Select auto or manual control of tDPCH setting. This is an advanced control and tDPCH value is normally given when the selected code is detected as an Active Channel code.

OFF - tDPCH can manually be set by :CALCulate:CDPower:TDPCh.

ON - tDPCH is given automatically as a result of measurement for the specified Code Channel.

Notes	Set tDPCH value manually, when :CALCulate:CDPower:TDPCh:AUTO is OFF. This value is set at its auto number if Time Offset detection Auto mode is set to ON.
Remote Command Notes	OFF – tDPCH can manually be set by :CALCulate:CDPower:TDPCh. ON – tDPCH is given automatically as a result of measurement for the specified Code Channel.
Preset	0, , ON
State Saved	Saved in instrument state.
SCPI Resolution	1
Key Path	Meas Setup, More, More, Symbol Analysis
Remarks:	You must be in the W-CDMA mode to use this command. Use INSTRument:SElect to set the mode.

Code Domain—Computation Type

```
:CALCulate:CDPower:TYPE ABSolute|RELative  
:CALCulate:CDPower:TYPE?
```

Set the code domain power computation type to either the absolute power or the relative value to the mean power.

ABSolute – code domain power is computed as the absolute power.

RELative – code domain power is computed relative to the mean power.

Preset	RELative
State Saved	Saved in instrument state.
Range	Abs Rel
Key Path	Meas Setup

Remarks: You must be in the cdma2000 , W-CDMA, or 1xEV_DO mode to use this command. Use INSTRument:SElect to set the mode.

Code Domain—DPCH/E-DPCH Configuration

```
:CALCulate:CDPower:DPCH:MS:CONFigure  
C1|C2WDPdch|C2WODpdch|C3  
:CALCulate:CDPower:DPCH:MS:CONFigure?
```

This parameter configures how DPDCH, HS-DPCCH, E-DPCCH and E-DPDCH are recognized.

The parameter affects the following measurement results:

- Beta factor results
- Channel Type indication that comes with Demod Bits

Whether or not tHS-DPCCH setting is applied to the particular code channel. The parameter setting has been introduced in order to help the instrument algorithm determine the type of uplink channels it observes.

- 3GPP TS 25.213 V6.3.0 (2005–06) page 7 and 8 describes “Configuration #” parameter as follows. (The following clause 4.2.1 was cited from the standard.) 3GPP TS 25.213 V6.3.0 (2005–06)

4.2.1 Dedicated physical channels

The possible combinations of maximum number of the respective dedicated physical channels which a UE may support simultaneously in addition to the DPCCH are specified in table 0. The actual UE capability may be lower than the values specified in table 0; the actual dedicated physical channel configuration is indicated by higher layer signalling.

Configuration #	DPDCH	HS-DPCCH	E-DPDCH	E-DPCCH
1	6	1	-	-
2	1	1	2	1
3	-	1	4	1

Example	:CALCulate:CDPower:DPCH:MS:CONFigure C3
Dependencies and Couplings	This parameter is valid if HSDPA/HSUPA mode is enabled and radio device is MS and Sync Type is DPCCH.
Preset	C1
State Saved	Saved in instrument state.
Range	Config 1 (no E-DPCH) Config 2 w/ DPDCH Config 2 w/o DPDCH Config 3 (no DPDCH)
Key Path	Meas Setup, More

Data Query

:CALCulate:DATA [n] ?

Returns the designated measurement data for the currently selected measurement and sub-opcode.

n = any valid sub-opcode for the current measurement. See the “MEASure Group of Commands” on page 654 for information on the data that can be returned for each measurement.

For sub-opcodes that return trace data use the :CALCulate:DATA [n] :COMPRESS? command below.

Calculate/Compress Trace Data Query

:CALCulate:DATA<n>:COMPRESS?

**BLOCK | CFIT | MAXimum | MINimum | MEAN | DMEan
| RMS | SAMPle | SDEVIation [, <soffset> [, <length> [, <roffset>
[, <rlimit>]]]]**

Returns compressed data for the specified trace data. The data is returned in the same units as the original trace and only works with the currently selected measurement. The command is used with a sub-opcode *<n>* since measurements usually return several types of trace data. See the following table for the sub-opcodes for the trace data names that are available in each measurement. For sub-opcodes that return scalar data use the :CALCulate:DATA [n] ? command above.

This command is used to compress or decimate a long trace to extract and return only the desired data. A typical example would be to acquire N frames of GSM data and return the mean power of the first burst in each frame. The command can also be used to identify the best curve fit for the data.

BLOCK or block data - returns all the data points from the region of the trace data that you specify. For example, it could be used to return the data points of an input signal over several timeslots, excluding the portions of the trace data that you do not want.

CFIT or curve fit - applies curve fitting routines to the data. <soffset> and <length> are required to define the data that you want. <roffset> is an optional parameter for the desired order of the curve equation. The query will return the following values: the x-offset (in seconds) and the curve coefficients ((order + 1) values).

MAX, **MEAN**, **DME**, **MIN**, **RMS**, **SAMP** and **SDEV** return one data value for each specified region (or <length>) of trace data, for as many regions as possible until you run out of trace data (using <roffset> to specify regions). Or they return the number regions you specify (using <rlimit>) ignoring any data beyond that.

- **MAXimum** - returns the maximum data point for the specified region(s) of trace data. For I/Q trace data, the maximum magnitude of the I/Q pairs is returned.
- **MINimum** - returns the minimum data point for the specified region(s) of trace data. For I/Q trace data, the minimum magnitude of the I/Q pairs is returned.
- **MEAN** - returns the arithmetic mean of the data point values for the specified region(s) of trace data, in the same units as the original trace data.

Equation 6-1 Mean Value of Data Points for Specified Region(s)

$$\text{MEAN} = \frac{1}{n} \sum_{X_i \in \text{region(s)}} X_i$$

where X_i is a data point value, and n is the number of data points in the specified region(s).

For I/Q trace data, the mean of the magnitudes of the I/Q pairs is returned.

NOTE: If the original trace data is in dB, this function returns the arithmetic mean of those log values, not the log of the mean power. The mean of the log is a superior measurement technique when measuring CW signals in the presence of noise; the mean of the power, expressed in dB, is useful in power measurements such as Channel Power. To accomplish measurement of the mean of the power, use the RMS option, or use power units (watts, W) in the original trace. When the original trace is in voltage units, this function returns the mean voltage. This is occasionally useful in EMI applications.

When the original trace is made of I/Q pairs, the magnitude (in voltage units) of the trace elements is used for the X_i terms, and the units of the returned value is volts.

Equation 6-2 Mean Value of I/Q Data Pairs for Specified Region(s)

$$\text{MEAN} = \frac{1}{n} \sum_{X_i \in \text{region(s)}} |X_i|$$

where $|X_i|$ is the magnitude of an I/Q pair, and n is the number of I/Q pairs in the specified region(s).

- **DMEan** - returns the mean power (in dB/dBm) of the data point values (expressed in dB/dBm) for the specified region(s) of trace data.

DMEan was intended to be used for averaging of power trace data expressed in units of dBm or dB. For example, in CDMA chip power measurements (decision point power at chip timing), when the original trace data is expressed in dBm, and the measurement length is equal to or greater than 1 slot, DMEan is useful to calculate the slot average power over the entire slot duration).

DMEan does not have any known application when the original trace data is in voltage or power (W) units. When the original trace is made of I/Q pairs, the magnitude (in voltage units) of the trace elements is used for the X_i terms, and the units of the returned value is volts. In other words, all I/Q compression functions act on the magnitude of the I/Q pairs, and are therefor only useful for decibel-formatted inputs.

Equation 6-3 DMEan Value of Data Points for Specified Region(s)

$$\text{DMEan} = 10 \times \log_{10} \left(\frac{1}{n} \sum_{X_i \in \text{region}(s)} \left(10^{\frac{X_i}{10}} \right) \right)$$

- **RMS** - returns the arithmetic RMS (Root Means Squared) of the data point values for the specified region(s) of trace data, using the original units of measurement.

Equation 6-4 RMS Value of Data Points for Specified Region(s)

$$\text{RMS} = \sqrt{\frac{1}{n} \sum_{X_i \in \text{region}(s)} X_i^2}$$

where X_i is a data point value, and n is the number of data points in the specified region(s).

For I/Q trace data, the RMS of the magnitudes of the I/Q pairs is returned.

NOTE

This function is very useful for I/Q trace data. However, if the original trace data is in dB, this function returns the RMS of the log values which is not usually needed. Similarly, if the original trace data is in power units (W, watts), there is no known usefulness of this function.

Once you have the RMS value for a region of I/Q trace data, you may want to calculate the mean power. You must convert this RMS I/Q value (peak volts) to power in dB.

$$20 \times \text{Log}_{10}[10 \times (\text{rms value})] + 13$$

The value “13” above is derived from the the use of a 50 ohm reference (–17 dB), and the conversion from dBW (decibels relative to a watt) to dBm (+30 dBm for 1 Watt), giving a final value of +13.

When the original trace is made of I/Q pairs, the magnitude (in voltage units) of the trace elements is used for the X_i terms, and the units of the returned value is volts. Because the I/Q data represents a multiplier on assumed sine and cosine terms, the user’s conversion from RMS voltage to power would be 3 dB different than if the X_i term were an envelope voltage; thus, the “+13” in the equation above would be +10.

- **SAMPLE** - returns the first data value for the specified region(s) of trace data. For I/Q trace data, the first I/Q pair is returned.
- **SDEViation** - returns the arithmetic standard deviation for the data point values for the specified region(s) of trace data.

Equation 6-5 Standard Deviation of Data Point Values for Specified Region(s)

$$\text{SDEV} = \sqrt{\frac{1}{n} \sum_{X_i \in \text{region}(s)} (X_i - \bar{X})^2}$$

where X_i is a data point value, \bar{X} is the arithmetic mean of the data point values for the specified region(s), and n is the number of data points in the specified region(s).

For I/Q trace data, the standard deviation of the magnitudes of the I/Q pairs is returned.

When the original trace is made of I/Q pairs, the magnitude (in voltage units) of the trace elements is used for the X_i terms, and the units of the returned value is volts.

Figure 6-1 Sample Trace Data - Constant Envelope

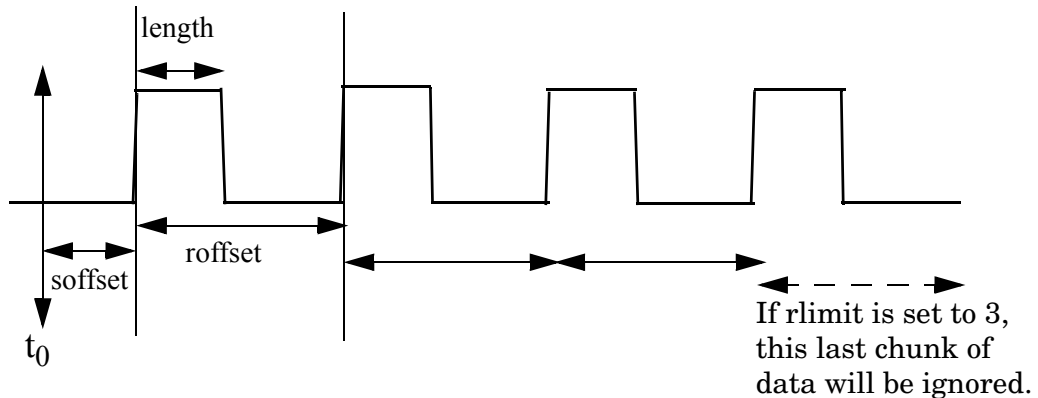
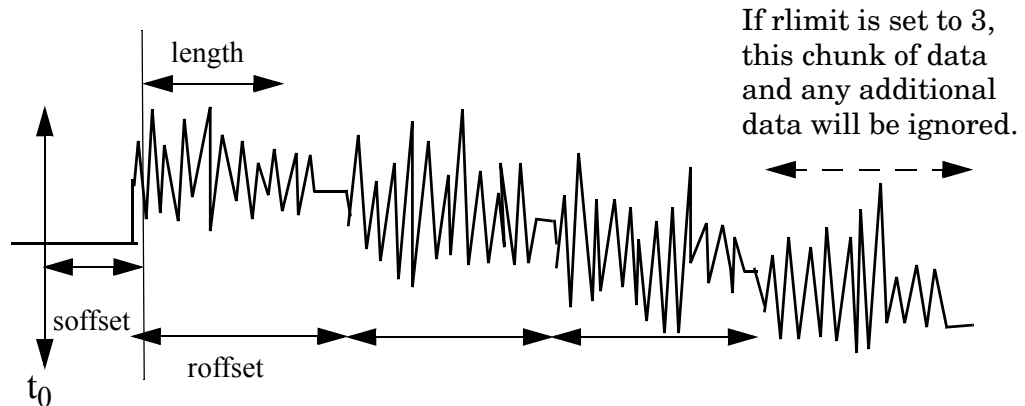


Figure 6-2 Sample Trace Data - Not Constant Envelope



<soffset> - start offset is an optional real number (in seconds). It specifies the amount of data at the beginning of the trace that will be ignored before the decimation process starts. It is the time from the start of the trace to the point where you want to start using the data. The default value is zero.

<length> - is an optional real number (in seconds). It defines how much data will be compressed into one value. This parameter has a default value equal to the current trace length.

<roffset> - repeat offset is an optional real number (in seconds). It defines the beginning of the next field of trace elements to be compressed. This is relative to the beginning of the previous field. This parameter has a default value equal to the <length> variable.

<rlimit> - repeat limit is an optional integer. It specifies the number of data items that you want returned. It will ignore any additional items beyond that number. You can use the Start offset and the Repeat limit to pick out exactly what part of the data you want to use. The default value is all the data.

Example: To query the mean power of a set of GSM bursts:

1. Set the waveform measurement sweep time to acquire at least one burst.
2. Set the triggers such that acquisition happens at a known position relative to a burst.
3. Then query the mean burst levels using, `CALC:DATA2:COMP? MEAN,24e-6,526e-6` (These parameter values correspond to GSM signals, where 526e-6 is the length of the burst in the slot and you just want 1 burst.)

NOTE There is a more detailed example in the “Improving the Speed of Your Measurements” section in the PSA Series *User’s and Programmer’s Reference*. There is also a sample program in the Programming Fundamentals chapter of that book, and a copy of it is on the documentation CD-ROM.

NOTE There is a more detailed example in the “Improving the Speed of Your Measurements” section in the E4406A *Programmer’s Guide*. There is also a sample program in the Programming Fundamentals chapter of that book, and a copy of it is on the documentation CD-ROM.

Remarks: The optional parameters must be entered in the specified order. For example, if you want to specify <length>, you must also specify <soffset>.

This command uses the data in the format specified by FORMat:DATA, returning either binary or ASCII data.

History: Added in revision A.03.00
Changed in revision A.05.00

Measurement	Available Traces	Markers Available?
ACP - adjacent channel power (Basic, cdmaOne, cdma2000, W-CDMA, iDEN, WiDEN, NADC, PDC modes)	no traces (n=0) ^a for I/Q points	no markers
BER - bit error rate (iDEN, WiDEN mode)	no traces (n=0) ^a for I/Q data	no markers

Measurement	Available Traces	Markers Available?
CDPower - code domain power (cdmaOne mode)	POWer ($n=2$) ^a TIMing ($n=3$) ^a PHASe ($n=4$) ^a ($n=0$) ^a for I/Q points	yes
CDPower - code domain power (cdma2000 mode)	CDPower ($n=2$) ^a EVM ($n=5$) ^a MERRor ($n=6$) ^a PERRor ($n=7$) ^a SPOWer ($n=9$) ^a CPOWer ($n=10$) ^a ($n=0$) ^a for I/Q points	yes
CDPower - code domain power (W-CDMA mode)	CDError ($n=13$) ^a CDPower ($n=2$) ^a EVM ($n=5$) ^a MERRor ($n=6$) ^a PERRor ($n=7$) ^a SPOWer ($n=9$) ^a CPOWer ($n=10$) ^a ($n=0$) ^a for I/Q points	yes
CHPower - channel power (Basic, cdmaOne, cdma2000, W-CDMA modes)	SPECtrum ($n=2$) ^a ($n=0$) ^a for I/Q points	no markers
CSPur - spurs close (cdmaOne mode)	SPECtrum ($n=2$) ^a ULIMit ($n=3$) ^a ($n=0$) ^a for I/Q points	yes
EEVM - EDGE error vector magnitude (EDGE mode)	EVMerror ($n=2$) ^a MERRor ($n=3$) ^a PERRor ($n=4$) ^a ($n=0$) ^a for I/Q points	yes

Measurement	Available Traces	Markers Available?
EORFspectr - EDGE output RF spectrum (EDGE mode)	RFEMod ($n=2$) ^a RFESwitching ($n=3$) ^a SPEMod ($n=4$) ^a LIMMod ($n=5$) ^a ($n=0$) ^a for I/Q points	yes, only for a single offset yes, only for multiple offsets
EPVTime - EDGE power versus time (EDGE mode)	RFENvelope ($n=2$) ^a UMASk ($n=3$) ^a LMASk ($n=4$) ^a ($n=0$) ^a for I/Q points	yes
ETSPur - EDGE transmit band spurs (EDGE mode)	SPECTrum ($n=2$) ^a ULIMit ($n=3$) ^a ($n=0$) ^a for I/Q points	yes
EVM - error vector magnitude (NADC, PDC modes)	EVM ($n=2$) ^a MERRor ($n=3$) ^a PERRor ($n=4$) ^a ($n=0$) ^a for I/Q points	yes
EVMQpsk - QPSK error vector magnitude (cdma2000, W-CDMA modes)	EVM ($n=2$) ^a MERRor ($n=3$) ^a PERRor ($n=4$) ^a ($n=0$) ^a for I/Q points	yes
IM - intermodulation (cdma2000, W-CDMA modes)	SPECTrum ($n=2$) ^a ($n=0$) ^a for I/Q points	yes
MCPower - multi-carrier power (W-CDMA mode)	no traces ($n=0$) ^a for I/Q points	no markers
OBW - occupied bandwidth (cdmaOne, cdma2000, iDEN, WiDEN, PDC, W-CDMA modes)	no traces ($n=0$) ^a for I/Q points	no markers

Measurement	Available Traces	Markers Available?
ORFSpectrum - output RF spectrum (GSM, EDGE mode)	RFEMod ($n=2$) ^a RFESwitching ($n=3$) ^a SPEMod ($n=4$) ^a LIMMod ($n=5$) ^a ($n=0$) ^a for I/Q points	yes, only for a single offset yes, only for multiple offsets
PFERror - phase and frequency error (GSM, EDGE mode)	PERRor ($n=2$) ^a PFERror ($n=3$) ^a RFENvelope ($n=4$) ^a ($n=0$) ^a for I/Q points	yes
PStatistic - power statistics CCDF (Basic, cdma2000, W-CDMA modes)	MEASured ($n=2$) ^a GAUSian ($n=3$) ^a REFerence ($n=4$) ^a ($n=0$) ^a for I/Q points	yes
PVTime - power versus time (GSM, EDGE, Service modes)	RFENvelope ($n=2$) ^a UMASk ($n=3$) ^a LMASk ($n=4$) ^a ($n=0$) ^a for I/Q points	yes
RHO - modulation accuracy (cdmaOne, cdma2000 mode)	($n=0$) ^a for I/Q points EVM ($n=2$) ^a MERRor ($n=3$) ^a PERRor ($n=4$) ^a ($n=0$) ^a for I/Q points	yes
RHO - modulation accuracy (W-CDMA mode)	($n=0$) ^a for I/Q points CDPower ($n=8$) EVM ($n=2$) ^a MERRor ($n=3$) ^a PERRor ($n=4$) ^a ($n=0$) ^a for I/Q points	yes

Measurement	Available Traces	Markers Available?
SEMask - spectrum emissions mask (cdma2000, W-CDMA mode)	SPECTrum ($n=2$) ^a $(n=0)$ ^a for I/Q points	yes
TSPur - transmit band spurs (GSM, EDGE mode)	SPECTrum ($n=2$) ^a ULIMit ($n=3$) ^a $(n=0)$ ^a for I/Q points	yes
TXPower - transmit power (GSM, EDGE mode)	RFENvelope ($n=2$) ^a IQ ($n=8$) ^a $(n=0)$ ^a for I/Q points	yes
SPECTrum - (frequency domain) (all modes)	RFENvelope ($n=2$) ^a for Service mode IQ ($n=3$) ^a SPECTrum ($n=4$) ^a ASPectrum ($n=7$) ^a $(n=0)$ ^a for I/Q points	yes
WAVEform - (time domain) (all modes)	RFENvelope ($n=2$) ^a (also for Signal Envelope trace) IQ ($n=5$) ^a $(n=0)$ ^a for I/Q points	yes

a. The n number indicates the sub-opcode that corresponds to this trace. Detailed descriptions of the trace data can be found in the MEASure subsystem documentation by looking up the sub-opcode for the appropriate measurement.

Calculate Peaks of Trace Data

```
:CALCulate:DATA<n>:PEAKs?  
<threshold>,<excursion>[,AMPLitude|FREQuency|TIME]
```

Returns a list of peaks for the designated trace data *n* for the currently selected measurement. The peaks must meet the requirements of the peak threshold and excursion values.

The command can only be used with specific *<n>* (sub-opcode) values, for measurement results that are trace, or scalar, data. See the table above for the appropriate sub-opcodes. Both real and complex traces can be searched, but complex traces are converted to magnitude in dBm. Sub-opcode *n=0*, is the raw trace data which cannot be searched for peaks. Sub-opcode *n=1*, is the scalar data which also cannot be searched for peaks.

Threshold - is the level below which trace data peaks are ignored

Excursion - To be defined as a peak, the signal must rise above the threshold by a minimum amplitude change (excursion). Excursion is measured from the lowest point above the threshold (of the rising edge of the peak), to the highest signal point that begins the falling edge. If a signal valley is higher than the threshold, then the excursion is referenced to that valley, and a peak is only defined if the signal following that valley exceeds the excursion.

Amplitude - lists the peaks in order of descending amplitude, so the highest peak is listed first. This is the default peak order listing if the optional parameter is not specified.

Frequency - lists the peaks in order of occurrence, left to right across the x-axis

Time - lists the peaks in order of occurrence, left to right across the x-axis

Example: Select the spectrum measurement.

Use **CALC:DATA4:PEAK? -40,10,FREQ** to identify the peaks above -40 dBm, with excursions of at least 10 dB, in order of increasing frequency.

Query Results: Returns a list of floating-point numbers. The first value in the list is the number of peak points that follow. A peak point consists of two values: a peak amplitude followed by the its corresponding frequency (or time).

If no peaks are found the peak list will consist of only the number of peaks, (0).

The peak list is limited to 100 peaks. Peaks in excess of 100 are ignored.

Remarks: This command uses the data setting specified by the FORMat:DATA command and can return real 32-bit, real 64-bit, or ASCII data. The default data format is ASCII.

History: For E4406A:
Added in revision A.03.00 and later

QPSK EVM - Limits

QPSK Error Vector Magnitude—IQ Offset Include

`:CALCulate:EVMQpsk:IQOffset:INCLude OFF|ON|0|1`

`:CALCulate:EVMQpsk:IQOffset:INCLude?`

Select I/Q origin offset error is included into EVM calculation or not.

ON - I/Q origin offset is included into EVM calculation.

OFF - I/Q origin offset is excluded from EVM calculation.

Factory Preset: ON

Remarks: You must be in the W-CDMA mode to use this command. Use INSTRument:SElect to set the mode.

QPSK Error Vector Magnitude—Frequency Error Limit

`:CALCulate:EVMQpsk:LIMit:FERRor <float>`

`:CALCulate:EVMQpsk:LIMit:FERRor?`

Set the Frequency Error Limit in Hz.

Factory Preset: 200.0 Hz

Range: 0.0 to 300.0 kHz

Remarks: You must be in the W-CDMA mode to use this command. Use INSTRument:SElect to set the mode.

QPSK Error Vector Magnitude—RMS EVM Limit

:CALCulate:EVMQpsk:LIMit:RMS <float>

:CALCulate:EVMQpsk:LIMit:RMS?

Set the I/Q origin offset error limit in dB.

Factory Preset: 17.5 %

Range: 0.0 to 100.0 %

Remarks: You must be in the W-CDMA mode to use this command. Use INSTRument:SElect to set the mode.

CALCulate:MARKers Subsystem

Markers can be put on your displayed measurement data to supply information about specific points on the data. Some of the things that markers can be used to measure include: precise frequency at a point, minimum or maximum amplitude, and the difference in amplitude or frequency between two points.

When using the marker commands you must specify the measurement in the SCPI command. We recommend that you use the marker commands only on the current measurement. Many marker commands will return invalid results, when used on a measurement that is not current. (This is true for commands that do more than simply setting or querying an instrument parameter.) No error is reported for these invalid results.

You must make sure that the measurement is completed before trying to query the marker value. Using the MEASure or READ command, before the marker command, forces the measurement to complete before allowing the next command to be executed.

Each measurement has its own instrument state for marker parameters. Therefore, if you exit the measurement, the marker settings in each measurement are saved and are then recalled when you change back to that measurement.

Basic Mode - <measurement> key words

- ACPr - no markers (E4406A only)
- CHPower - no markers (E4406A only)
- PStatistic - markers available (E4406A only)
- SPECTrum - markers available
- WAVeform - markers available

Service Mode - <measurement> key words

- PVTime - no markers
- SPECTrum - markers available
- WAVEform - markers available

1xEV-DO Mode - <measurement> key words

- CDPower - markers available
- CHPower - no markers
- EVMQpsk - markers available
- IM - markers available
- OBW - no markers
- PSTatistic - markers available
- PVTime - markers available
- RHO - markers available
- SEMask - markers available
- SPECTrum - markers available
- WAVEform - markers available

cdmaOne Mode - <measurement> key words

- ACPr - no markers
- CHPower - no markers
- CDPower - markers available
- CSPur - markers available
- RHO - markers available
- SPECTrum - markers available
- WAVEform - markers available

cdma2000 Mode - <measurement> key words

- ACP - no markers
- CDPower - markers available
- CHPower - no markers
- EVMQpsk - markers available
- IM - markers available
- OBW - no markers
- PSTatistic - markers available
- RHO - markers available
- SEMask - markers available
- SPECTrum - markers available
- WAVEform - markers available

GSM (with EDGE) Mode - <measurement> key words

- EEVM - markers available
- EORFspectr - markers available
- EPVTime - no markers
- ETSPur - markers available
- ORFSpectrum - markers available
- PFERror - markers available
- PVTime - no markers
- SPECtrum - markers available
- TSPur - markers available
- TXPower - no markers
- WAVeform - markers available

GSM Mode - <measurement> key words

- ORFSpectrum - markers available
- PFERror - markers available
- PVTime - no markers
- SPECtrum - markers available
- TSPur - markers available
- TXPower - no markers
- WAVeform - markers available

iDEN Mode - <measurement> key words

- ACP - no markers
- BER - no markers
- OBW - no markers
- SPECtrum - markers available
- WAVeform - markers available

NADC Mode - <measurement> key words

- ACP - no markers
- EVM - markers available
- SPECtrum - markers available
- WAVeform - markers available

PDC Mode - <measurement> key words

- ACP - no markers
- EVM - markers available
- OBW - no markers
- SPECtrum - markers available
- WAVeform - markers available

W-CDMA Mode - <measurement> key words

- ACP - no markers
- CDPower - markers available
- CHPower - no markers
- EVMQpsk - markers available
- IM - markers available
- MCPower - no markers
- OBW - no markers
- PSTatistic - markers available
- PCONtrol - markers available
- PSTatistic - markers available
- PVTmask - markers available
- SEMask - markers available
- SPECTrum - markers available
- WAVEform - markers available

Example:

Suppose you are using the Spectrum measurement in your measurement personality. To position marker 2 at the maximum peak value of the trace that marker 2 is currently on, the command is:

```
:CALCulate:SPECTrum:MARKer2:MAXimum
```

You must make sure that the measurement is completed before trying to query the marker value. Use the MEASure or READ command before using the marker command. This forces the measurement to complete before allowing the next command to be executed.

Markers All Off on All Traces

```
:CALCulate:<measurement>:MARKer:AOFF
```

Turns off all markers on all the traces in the specified measurement.

Example: **CALC:SPEC:MARK:AOFF**

Remarks: The keyword for the current measurement must be specified in the command. (Some examples include: SPECTrum, WAVEform)

Key Path: **Marker, More, Marker All Off**

Marker Function Result

:CALCulate:<measurement>:MARKer [1] | 2 | 3 | 4:FUNction:RESult?

Queries the result of the currently active marker function. The measurement must be completed before querying the marker. A particular measurement may not have all the types of markers available.

The marker must have already been assigned to a trace. Use **:CALCulate:<measurement>:MARKer [1] | 2 | 3 | 4:TRACe** to assign a marker to a particular trace.

Example: **CALC:SPEC:MARK:FUNC:RES?**

Remarks: The keyword for the current measurement must be specified in the command. (Some examples include: SPECTrum, WAVeform)

Key Path: **Marker, Marker Function**

Marker Peak (Maximum) Search

:CALCulate:<measurement>:MARKer [1] | 2 | 3 | 4:MAXimum

Places the selected marker on the highest point on the trace that is assigned to that particular marker number.

The marker must have already been assigned to a trace. Use **:CALCulate:<measurement>:MARKer [1] | 2 | 3 | 4:TRACe** to assign a marker to a particular trace.

Example: **CALC:SPEC:MARK1:MAX**

Remarks: The keyword for the current measurement must be specified in the command. (Some examples include: SPECTrum, WAVeform)

Key Path: **Search**

Marker Peak (Minimum) Search

:CALCulate:<measurement>:MARKer [1] | 2 | 3 | 4:MINimum

Places the selected marker on the lowest point on the trace that is assigned to that particular marker number.

The marker must have already been assigned to a trace. Use **:CALCulate:<measurement>:MARKer [1] | 2 | 3 | 4:TRACe** to assign a marker to a particular trace.

Example: **CALC:SPEC:MARK2 MIN**

Remarks: The keyword for the current measurement must be specified in the command. (Some examples include: SPECTrum, WAVeform)

Marker Mode

E4406A (all modes):

PSA Series (Basic, cdmaOne, cdma2000, W-CDMA, GSM/EDGE, NADC, PDC modes):

**:CALCulate:<measurement>:MARKer [1] | 2 | 3 | 4:MODE
POSition|DELTA**

ESA/PSA Series (Phase Noise mode only):

**:CALCulate:<measurement>:MARKer [1] | 2 | 3 | 4:MODE
POSition|DELTA|RMSDegree
|RMSRadian|RFM|RMSJitter|OFF**

:CALCulate:<measurement>:MARKer [1] | 2 | 3 | 4:MODE?

E4406A/PSA: Selects the type of marker to be a normal position-type marker or a delta marker. A specific measurement may not have both types of markers. For example, several measurements only have position markers

ESA/PSA Phase Noise Mode: Selects the type of marker to be a normal position-type marker, a delta marker or an RMS measurement marker.

The marker must have already been assigned to a trace. Use **:CALCulate:<measurement>:MARKer [1] | 2 | 3 | 4:TRACe** to assign a marker to a particular trace.

Example: **CALC:SPEC:MARK:MODE DELTA**

Remarks: For the delta mode only markers 1 and 2 are valid.

The keyword for the current measurement must be specified in the command. (Some examples include: SPECTrum, WAVeform)

Key Path: **Marker, Marker [Delta]**

Marker On/Off

```
:CALCulate:<measurement>:MARKer [1] | 2 | 3 | 4 [:STATe] OFF | ON | 0 | 1
:CALCulate:<measurement>:MARKer [1] | 2 | 3 | 4 [:STATe] ?
```

Turns the selected marker on or off.

The marker must have already been assigned to a trace. Use

```
:CALCulate:<measurement>:MARKer [1] | 2 | 3 | 4 :TRACe
```

to assign a marker to a particular trace.

Example: **CALC:SPEC:MARK2: ON**

Remarks: The keyword for the current measurement must be specified in the command. (Some examples include: SPECTrum, AREFERENCE, CFLOCATION, WAVeform)

The WAVeform measurement only has two markers available.

Key Path: **Marker, Select then Marker Normal or Marker On Off**

Marker to Trace

```
:CALCulate:<measurement>:MARKer [1] | 2 | 3 | 4 :TRACe <trace_name>
:CALCulate:<measurement>:MARKer [1] | 2 | 3 | 4 :TRACe?
```

Assigns the specified marker to the designated trace. Not all types of measurement data can have markers assigned to them.

Example: With the WAVeform measurement selected, a valid command is **CALC:SPEC:MARK2:TRACE rfenvelope**.

Range: The names of valid traces are dependent upon the selected measurement. See the following table for the available trace names. The trace name assignment is independent of the marker number.

Remarks: The keyword for the current measurement must be specified in the command. (Some examples include: SPECTrum, WAVeform)

Key Path: **Marker, Marker Trace**

Measurement	Available Traces	Markers Available?
ACP - adjacent channel power (Basic, cdmaOne, cdma2000, W-CDMA, iDEN (E4406A only), WiDEN (E4406A only), NADC, PDC modes)	no traces ($n=0$) ^a for I/Q points	no markers

Measurement	Available Traces	Markers Available?
BER - bit error rate (iDEN, WiDEN mode, E4406A only)	no traces (n=0) ^a for I/Q data	no markers
CDPower - code domain power (cdmaOne mode)	POWer (n=2) ^a TIMing (n=3) ^a PHASe (n=4) ^a (n=0) ^a for I/Q points	yes
CDPower - code domain power (cdma2000, W-CDMA, 1xEV-DO modes)	CDPower (n=2) ^a EVM (n=5) ^a MERRor (n=6) ^a PERRor (n=7) ^a SPOWer (n=9) ^a CPOWer (n=10) ^a (n=0) ^a for I/Q points	yes
CHPower - channel power (Basic, cdmaOne, cdma2000, W-CDMA, 1xEV-DO modes)	SPECTrum (n=2) ^a (n=0) ^a for I/Q points	no markers
CSPur - spurs close (cdmaOne mode)	SPECTrum (n=2) ^a ULIMit (n=3) ^a (n=0) ^a for I/Q points	yes
EEVM - EDGE error vector magnitude (EDGE mode)	EVMerror (n=2) ^a MERRor (n=3) ^a PERRor (n=4) ^a (n=0) ^a for I/Q points	yes
EORFspectr - EDGE output RF spectrum (EDGE mode)	RFEMod (n=2) ^a RFESwitching (n=3) ^a SPEMod (n=4) ^a LIMMod (n=5) ^a (n=0) ^a for I/Q points	yes, only for a single offset yes, only for multiple offsets

Measurement	Available Traces	Markers Available?
EPVTime - EDGE power versus time (EDGE mode)	RFENvelope ($n=2$) ^a UMASk ($n=3$) ^a LMASk ($n=4$) ^a ($n=0$) ^a for I/Q points	yes
ETSPur - EDGE transmit band spurs (EDGE mode)	SPECtrum ($n=2$) ^a ULIMit ($n=3$) ^a ($n=0$) ^a for I/Q points	yes
EVM - error vector magnitude (NADC, PDC modes)	EVM ($n=2$) ^a MERRor ($n=3$) ^a PERRor ($n=4$) ^a ($n=0$) ^a for I/Q points	yes
EVMQpsk - QPSK error vector magnitude (cdma2000, W-CDMA, 1xEV-DO modes)	EVM ($n=2$) ^a MERRor ($n=3$) ^a PERRor ($n=4$) ^a ($n=0$) ^a for I/Q points	yes
IM - intermodulation (cdma2000, W-CDMA, 1xEV-DO modes)	SPECtrum ($n=2$) ^a ($n=0$) ^a for I/Q points	yes
MCPower - multi-carrier power (W-CDMA mode)	no traces ($n=0$) ^a for I/Q points	no markers
OBW - occupied bandwidth (cdmaOne, cdma2000, iDEN (E4406A only), WiDEN (E4406A only), PDC, W-CDMA, 1xEV-DO modes)	no traces ($n=0$) ^a for I/Q points	no markers
ORFSpectrum - output RF spectrum (GSM, EDGE mode)	RFEMod ($n=2$) ^a RFESwitching ($n=3$) ^a SPEMod ($n=4$) ^a LIMMod ($n=5$) ^a ($n=0$) ^a for I/Q points	yes, only for a single offset yes, only for multiple offsets

Measurement	Available Traces	Markers Available?
PFERror - phase and frequency error (GSM, EDGE mode)	PERRor ($n=2$) ^a PFERror ($n=3$) ^a RFENvelope ($n=4$) ^a ($n=0$) ^a for I/Q points	yes
PSTatistic - power statistics CCDF (Basic, cdma2000, W-CDMA, 1xEV-DO modes)	MEASured ($n=2$) ^a GAUSSian ($n=3$) ^a REFerence ($n=4$) ^a ($n=0$) ^a for I/Q points	yes
PVTime - power versus time (GSM, EDGE, 1xEV-DO, Service (E4406A only) modes)	RFENvelope ($n=2$) ^a UMASk ($n=3$) ^a LMASk ($n=4$) ^a ($n=0$) ^a for I/Q points	yes
RHO - modulation quality (cdmaOne, cdma2000, W-CDMA, 1xEV-DO mode)	($n=0$) ^a for I/Q points EVM ($n=2$) ^a MERRor ($n=3$) ^a PERRor ($n=4$) ^a ($n=0$) ^a for I/Q points	yes
SEMask - spectrum emissions mask (cdma2000, W-CDMA, 1xEV-DO mode)	SPECTrum ($n=2$) ^a ($n=0$) ^a for I/Q points	yes
TSPur - transmit band spurs (GSM, EDGE mode)	SPECTrum ($n=2$) ^a ULIMit ($n=3$) ^a ($n=0$) ^a for I/Q points	yes
TXPower - transmit power (GSM, EDGE mode)	RFENvelope ($n=2$) ^a IQ ($n=8$) ^a ($n=0$) ^a for I/Q points	yes

Measurement	Available Traces	Markers Available?
SPECtrum - (frequency domain) (all modes)	RFENvelope ($n=2$) ^a for Service mode (E4406A only) IQ ($n=3$) ^a SPECtrum ($n=4$) ^a ASPECTrum ($n=7$) ^a ($n=0$) ^a for I/Q points	yes
WAVEform - (time domain) (all modes)	RFENvelope ($n=2$) ^a (also for Signal Envelope trace) IQ ($n=5$) ^a ($n=0$) ^a for I/Q points	yes

a. The n number indicates the sub-opcode that corresponds to this trace. Detailed descriptions of the trace data can be found in the MEASure subsystem documentation by looking up the sub-opcode for the appropriate measurement.

Marker X Value

:CALCulate:<measurement>:MARKer [1] | 2 | 3 | 4:X <param>

:CALCulate:<measurement>:MARKer [1] | 2 | 3 | 4:X?

Position the designated marker on its assigned trace at the specified X value. The parameter value is in X-axis units (which is often frequency or time).

The marker must have already been assigned to a trace. Use

:CALCulate:<measurement>:MARKer [1] | 2 | 3 | 4:TRACe to assign a marker to a particular trace.

The query returns the current X value of the designated marker. The measurement must be completed before querying the marker.

Example: **CALC:SPEC:MARK2:X 1.2e6 Hz**

Range: For Phase Noise mode: Graph Start Offset and Stop Offset frequencies.

Default Unit: Matches the units of the trace on which the marker is positioned

Remarks: The keyword for the current measurement must be specified in the command. (Some examples include: LPLot, ACP, CFLocation, WAVEform)

Key Path: **Marker, <active marker>, RPG**

Marker X Position

**:CALCulate:<measurement>:MARKer [1] | 2 | 3 | 4:X:POSition
<integer>**

:CALCulate:<measurement>:MARKer [1] | 2 | 3 | 4:X:POSition?

Position the designated marker on its assigned trace at the specified X position. A trace is composed of a variable number of measurement points. This number changes depending on the current measurement conditions. The current number of points must be identified before using this command to place the marker at a specific location.

The marker must have already been assigned to a trace. Use **:CALCulate:<measurement>:MARKer [1] | 2 | 3 | 4:TRACe** to assign a marker to a particular trace.

The query returns the current X position for the designated marker. The measurement must be completed before querying the marker.

Example: **CALC:SPEC:MARK:X:POS 500**

Range: 0 to a maximum of (3 to 920,000)

Remarks: The keyword for the current measurement must be specified in the command. (Some examples include: SPECTrum, WAVEform)

Key Path: **Marker, <active marker>, RPG**

Marker Readout Y Value

`:CALCulate:<measurement>:MARKer [1] | 2 | 3 | 4 :Y?`

Readout the current Y value for the designated marker on its assigned trace. The value is in the Y-axis units for the trace (which is often dBm).

The marker must have already been assigned to a trace. Use

`:CALCulate:<measurement>:MARKer [1] | 2 | 3 | 4 :TRACe` to assign a marker to a particular trace.

The measurement must be completed before querying the marker.

Example: `CALC:SPEC:MARK1:Y?`

Default Unit: Matches the units of the trace on which the marker is positioned

Remarks: The keyword for the current measurement must be specified in the command. (Some examples include: LPLot, ACP, CFLocation, WAVEform)

Occupied Bandwidth - Limits

Occupied Bandwidth—Frequency Band Limit

PDC, W-CDMA, 1xEV-DO mode

`:CALCulate:OBW:LIMit:FBLimit <freq>`

`:CALCulate:OBW:LIMit:FBLimit?`

iDEN, WiDEN mode (E4406A only)

`:CALCulate:OBWidth:LIMit:FBLimit <freq>`

`:CALCulate:OBWidth:LIMit:FBLimit?`

Set the frequency bandwidth limit in Hz.

Factory Preset: 32 kHz for PDC

20 kHz for iDEN (E4406A only)

1.48 MHz for cdma2000, 1xEV-DO

5 MHz for W-CDMA

Factory Preset: *WiDEN mode (E4406A)*

Carrier Configuration Setting	Default
Auto	Actual value depends on detected carrier configuration and cannot be changed.
25 kHz	20.0 kHz
50 kHz	45.0 kHz
50 kHz outer	95.0 kHz
75 kHz	70.0 kHz
100 kHz	95.0 kHz

Range: 10 kHz to 60 kHz for PDC, iDEN (E4406A only)
 10 kHz to 200 kHz for WiDEN (E4406A only)
 10 kHz to 10 MHz for cdma2000, W-CDMA, 1xEV-DO

Default Unit: Hz

Remarks: You must be in the WiDEN, iDEN (E4406A only), PDC, cdma2000, W-CDMA, or 1xEV-DO mode to use this command. Use INSTRument:SElect to set the mode.

For E4406A WiDEN mode, if you have set the Carrier Config ([:SENSe]:RADio:CARRier[:TYPE]) to AUTO, the value is set to the default value described in “[Factory Preset:](#)” above according to the actual carrier config (you can see detected carrier configuration by sending [:SENSe]:RADio:CARRier[:TYPE]:ACTual?) You can not change this value. Even if the you set this value using SCPI, it is ignored and the default value is used.

History: For E4406A:
 Version A.02.00 or later
 Widen is available on Version A.07.05 or later

Occupied Bandwidth—Limit Test

PDC, cdma2000, W-CDMA, 1xEV-DO mode

```
:CALCulate:OBW:LIMit[:TEST] OFF|ON|0|1
```

```
:CALCulate:OBW:LIMit[:TEST]?
```

iDEN, WiDEN mode (E4406A only)

```
:CALCulate:OBWidth:LIMit:STATe OFF|ON|0|1
```

```
:CALCulate:OBWidth:LIMit:STATe?
```

Turn the limit test function on or off.

Factory Preset: ON

Remarks: You must be in the iDEN (E4406A only), PDC, cdma2000, W-CDMA, or 1xEV-DO mode to use this command. Use INSTRument:SElect to set the mode.

History: For E4406A:
Version A.02.00 or later
Widen is απoαλβλε on Version A.07.05 or later

Power Control Commands

Power Control—Measurement Interval

```
:CALCulate:PCONtrol:PRACH:INTerval <float>
```

```
:CALCulate:PCONtrol:PRACH:INTerval?
```

Set Off-Power Measurement Interval for PRACH Power Measurement in chips.

Example	:CALCulate:PCONtrol:PRACH:INTerval 2368.0
Preset	2368.0
State Saved	Saved in instrument state.
SCPI Resolution	0.1
Key Path	Meas Setup, PRACH Power Meas
Front-panel Unit/Terminator Keys	chips

Range: 1.0 to 12800.0 chips

Remarks: You must be in the W-CDMA mode to use this command. Use INSTRument:SElect to set the mode.

Power Control—PRACH Message Length

```
:CALCulate:PCONtrol:PRACH:MLENgtH <float>
:CALCulate:PCONtrol:PRACH:MLENgtH?
```

Set Message Length for PRACH Power Measurement in seconds.

Example	:CALCulate:PCONtrol:PRACH:MLENgtH 20.0
Preset	20.0e-3
State Saved	Saved in instrument state.
SCPI Resolution	10.0e-3
Key Path	Meas Setup, PRACH Power Meas

Range: 0.01 s (10 ms) or 0.02 s (20 ms)
The number between 10 ms and 20 ms is rounded to the nearest number, either 10 ms or 20 ms.

Remarks: You must be in the W-CDMA mode to use this command. Use INSTRument:SElect to set the mode.

Power Control—Measurement Offset

```
:CALCulate:PCONtrol:PRACH:OFFSet <float>
:CALCulate:PCONtrol:PRACH:OFFSet?
```

Set Meas Offset (excluding period before and after reference point due to transient) for PRACH Power Measurement.

Example	:CALCulate:PCONtrol:PRACH:OFFSet 96.0
Preset	96.0
State Saved	Saved in instrument state.
SCPI Resolution	0.1
Key Path	Meas Setup, PRACH Power Meas
Front-panel Unit/Terminator Keys	chips

Range: 0.0 to 200.0 chips

Remarks: You must be in the W-CDMA mode to use this command. Use INSTRument:SElect to set the mode.

Power Control—PRACH Preamble Length

`:CALCulate:PCONtrol:PRACH:PLENgtH <float>`

`:CALCulate:PCONtrol:PRACH:PLENgtH?`

Set Preamble Length for PRACH Power Measurement.

Example	<code>:CALCulate:PCONtrol:PRACH:PLENgtH 4096.0</code>
Preset	4096.0
State Saved	Saved in instrument state.
SCPI Resolution	0.1
Key Path	Meas Setup, PRACH Power Meas
Front-panel Unit/Terminator Keys	chips

Range: 4000.0 to 4200.0 chips

Remarks: You must be in the W-CDMA mode to use this command. Use `INSTRument:SElect` to set the mode.

Power Control—Measurement Delay

`:CALCulate:PCONtrol:SLOT:DELay <float>`

`:CALCulate:PCONtrol:SLOT:DELay?`

Set Meas Delay for Slot Power Measurement in chips.

Example	<code>:CALCulate:PCONtrol:SLOT:DELay 96.0</code>
Setup	<code>:SENSe:RADIO:DEvice MS</code> <code>:CONF:PCON</code> <code>:INIT:CONT OFF</code> <code>:INIT:IMM</code> <code>:CALCulate:PCONtrol:SLOT:INTerval 1.0</code>
Preset	96.0
State Saved	Saved in instrument state.
SCPI Resolution	0.1
Key Path	Meas Setup, Slot Power Meas
Front-panel Unit/Terminator Keys	chips

Range: 0.0 to (:CALCulate:PCONtrol:SLOT:LENGth – :CALCulate:PCONtrol:SLOT:INTerval) chips

Remarks: You must be in the W-CDMA mode to use this command. Use INSTRument:SElect to set the mode.

Power Control—Measurement Interval

:CALCulate:PCONtrol:SLOT:INTerval <real>

:CALCulate:PCONtrol:SLOT:INTerval?

Specifies the number of chips to be used as the measuring interval for the averaged RMS power measurement.

Example :CALCulate:PCONtrol:SLOT:INTerval

Setup :SENSe:RADIO:DEvice MS

:CONF:PCON

:INIT:CONT OFF

:INIT:IMM

:CALCulate:PCONtrol:SLOT:DELay 0.0

Notes Default 2368 = 2560.0 – 96.0 ¥ 2

Preset 2368.0

State Saved Saved in instrument state.

SCPI Resolution 0.1

Key Path **Meas Setup, Slot Power Meas**

Front-panel chips

Unit/Terminator Keys

Power Control—Slot Length

`:CALCulate:PCONtrol:SLOT:LENGth <real>`

`:CALCulate:PCONtrol:SLOT:LENGth?`

Specifies the number of chips to be used as the integration time for the slot power measurement.

Example	<code>:CALCulate:PCONtrol:SLOT:LENGth</code>
Preset	2560.0
State Saved	Saved in instrument state.
SCPI Resolution	0.1
Key Path	Meas Setup, Slot Power Meas
Front-panel Unit/Terminator Keys	chips

Range: 768.0 to 25600.0 chips

Remarks: You must be in the W-CDMA mode to use this command. Use `INSTRument:SElect` to set the mode.

Power Control—Marker Trace

`:CALCulate:PCONtrol:MARKer [1] | 2 | 3 | 4 :TRACe
RFENvelope | SPOWer | POWer | CPHase | APHase | DPHase`

`:CALCulate:PCONtrol:MARKer [1] | 2 | 3 | 4 :TRACe?`

Selects the trace on which to place the selected marker.

RFENvelope	Place the selected marker on RF Envelope trace.
SPOWer POWer	Place the selected marker on Slot Power trace.
CPHase	Place the selected marker on Chip Phase trace.
APHase	Place the selected marker on Average Chip Phase trace.
DPHase	Place the selected marker on Phase Discontinuity trace.

Example	:CALCulate:PCONtrol:MARKer1:TRACe RFENvelope
Preset	RFENvelope
State Saved	Saved in instrument state.
Range	RF Envelope Slot Power Chip Phase Average Chip Phase Phase Discontinuity
Key Path	Marker

Power Statistic CCDF—Store Reference

```
:CALCulate:PStatistic:StORe:REFeRence ON|1
```

Store the currently measured trace as the user-defined reference trace. No query command is available.

Remarks: You must be in the cdma2000, W-CDMA, or 1xEV-DO mode to use this command. Use INSTRument:SElect to set the mode.

Modulation Accuracy - Limits

Modulation Accuracy (Rho)—Active Set Threshold

```
:CALCulate:RHO:ASET:THReshold <real>
```

```
:CALCulate:RHO:ASET:THReshold?
```

```
:CALCulate:RHO:ASET:THReshold:AUTO OFF|ON|0|1
```

```
:CALCulate:RHO:ASET:THReshold:AUTO?
```

Allows you to toggle the active channel identification function between Auto and Man. If set to Auto, the active channels are determined automatically by the internal algorithm. If set to Man, the active channel identification is determined by a user definable threshold ranging from 0.00 to -100.00 dB.

Notes In BTS mode, this command is effective when [:SENSe]:RHO:SBOundary[:BTS] is set to AUTO. In MS mode, this command is effective when [:SENSe]:RHO:SBOundary:MS is set to AUTO.

Remote Command Notes	Turn the automatic mode On or Off, for the active channel identification function. OFF – The active channel identification for each code channel is determined by a value set by CALCulate:RHO:ASET:THReshold. ON – The active channels are determined automatically by the internal algorithm.
Preset	0.0, , ON
State Saved	Saved in instrument state.
Resolution	0.01
Key Path	Meas Setup, More , More , Advanced
Range:	–100.0 to 0.0 dB
Remarks:	You must be in W-CDMA, cdma2000, or 1xEV-DO mode to use this command. Use INSTRument:SElect to set the mode.

Modulation Accuracy (Rho)—DTX/Burst Detect

```
:CALCulate:RHO:DTXBurst 0|1|OFF|ON
:CALCulate:RHO:DTXBurst?
```

For downlink signals, allows you the detection of the power burst, for either “CM”(Compressed Mode) or “DTX”. In case of “Compressed Mode”, the both I and Q symbol power is off. And, in case of “DTX” one of “I” or “Q” symbol power (or both) can be off.
 For uplink signals, allows you the detection of HS-DPCCH burst which sub-frame does not align with DPCCH slot boundary.

Example	:CALCulate:RHO:DTXB ON
Notes	If HSDPA/HSUPA option is enabled, this parameter is active and effective for both uplink and downlink. If HSDPA/HSUPA option is disabled, this parameter is active and effective only for downlink.
Preset	OFF
State Saved	Saved in instrument state.
Key Path	Meas Setup, More, More, Advanced

Modulation Accuracy (Rho)—Active Set Threshold Mode

`:CALCulate:RHO:ASET:THReshold:AUTO OFF | ON | 0 | 1`

`:CALCulate:RHO:ASET:THReshold:AUTO?`

Turn the automatic mode On or Off, for the active channel identification function.

OFF – The active channel identification for each code channel is determined by a value set by `CALCulate:RHO:ASET:THReshold`.

ON – The active channels are determined automatically by the internal algorithm.

Factory Preset: ON

Remarks: You must be in W-CDMA, cdma2000, or 1xEV-DO mode to use this command. Use `INSTRument:SElect` to set the mode.

Modulation Accuracy (Rho)—EVM Result I/Q Offset

`:CALCulate:RHO:IQOffset:INCLude OFF | ON | 0 | 1`

`:CALCulate:RHO:IQOffset:INCLude?`

Allows you to toggle the I/Q origin offset function between Std (standard) and Exclude.

Std : The measurement results for EVM, Rho, and Modulation Accuracy (Rho) error takes into account the I/Q origin offset.

Exclude : The measurement results for EVM, Rho, and Modulation Accuracy (Rho) error do not take into account the I/Q origin offset, and the message “EVM excludes I/Q Offset” is displayed in the lower right-hand graph display area.

Turn the automatic mode On or Off, for the I/Q origin offset function.

Exclude: OFF – The measurement results for EVM and Rho do not take into account the I/Q origin offset.

Include: ON – The measurement results for EVM and Rho take into account the I/Q origin offset.

Preset	ON
State Saved	Saved in instrument state.

Range	Std Exclude
Key Path	Meas Setup, More, More, Advanced

Modulation Accuracy (Rho)—Code Domain Error Limit (BTS)

```
:CALCulate:RHO:LIMit:CDERror <float>
:CALCulate:RHO:LIMit:CDERror?
```

Set the Peak Code Domain Error limit in dB.

Preset	100.0 Hz
State Saved	Saved in instrument state.
SCPI Resolution	1 Hz
Key Path	Meas Setup, Limits
Front-panel Unit/Terminator Keys	Hz kHz MHz GHz
Unit/Terminator Keys	Hz kHz MHz GHz

Range: -100.0 to 0.0 dB

Remarks: You must be in the cdma2000 or W-CDMA mode to use this command. Use INSTRument:SElect to set the mode.

Modulation Accuracy (Rho)—CPICH Tolerance (BTS)

```
:CALCulate:RHO:LIMit:CPICH[:BTS] <float>
:CALCulate:RHO:LIMit:CPICH[:BTS] ?
```

Set the tolerance of the CPICH power in dB. The limit value set by this command is only used, when the [:SENSe]:RADio:DEvice is set to BTS.

Preset	100.0
State Saved	Saved in instrument state.
SCPI Resolution	0.1
Key Path	Meas Setup, Limits

Range: 0.0 to 100.0 dB

Remarks: You must be in the W-CDMA mode to use this command. Use INSTRument:SElect to set the mode.

Modulation Accuracy (Rho)—CPICH Reference Power (BTS)

:CALCulate:RHO:LIMit:CPICH[:BTS]:POWER <float>

:CALCulate:RHO:LIMit:CPICH[:BTS]:POWER?

Set the CPICH Reference Power (relative power to total carrier power) in dB. The limit value set by this command is only used, when the [:SENSe]:RADio:DEVIce is set to BTS.

Preset	-10.0
State Saved	Saved in instrument state.
SCPI Resolution	0.1
Key Path	Meas Setup, Limits

Range: -100.0 to 0.0 dB

Remarks: You must be in the W-CDMA mode to use this command. Use INSTRument:SElect to set the mode.

Modulation Accuracy (Rho)—Frequency Error Limit

:CALCulate:RHO:LIMit:FERRor <float>

:CALCulate:RHO:LIMit:FERRor?

Set the Frequency Error limit in Hz.

Factory Preset: 100.0 Hz

Range: 0.0 to 500.0 Hz

Remarks: You must be in the W-CDMA mode to use this command. Use INSTRument:SElect to set the mode.

Modulation Accuracy (Rho)—Rho Limit

`:CALCulate:RHO:LIMit:RHO <float>`

`:CALCulate:RHO:LIMit:RHO?`

Specify a limit value for the Rho test.

Preset 0.50000

State Saved Saved in instrument state.

SCPI Resolution 0.00001

Key Path **Meas Setup, Limits**

Range: 0 to 1.0

Remarks: You must be in the cdma2000, W-CDMA, or 1xEV-DO mode to use this command. Use INSTRument:SElect to set the mode.

Modulation Accuracy (Rho)—RMS EVM Limit

`:CALCulate:RHO:LIMit:RMS <float>`

`:CALCulate:RHO:LIMit:RMS?`

Specify a limit value in percent for the rms EVM test.

Preset 17.5

State Saved Saved in instrument state.

SCPI Resolution 0.1

Key Path **Meas Setup, Limits**

Front-panel Unit/Terminator Keys %

Range: 0.0 to 100.0%

Remarks: You must be in the cdma2000, W-CDMA, or 1xEV-DO mode to use this command. Use INSTRument:SElect to set the mode.

Modulation Accuracy (Rho)—Peak EVM Limit

```
:CALCulate:RHO:LIMit:PEAK <real>
:CALCulate:RHO:LIMit:PEAK?
```

Allows you to set the limit for composite peak EVM measurement result.

Preset	200.0
State Saved	Saved in instrument state.
SCPI Resolution	0.1
Key Path	Meas Setup, Limits
Front-panel Unit/Terminator Keys	%
Range:	0.0 to 100.0%
Remarks:	You must be in the cdma2000, W-CDMA, or 1xEV-DO mode to use this command. Use INSTRument:SElect to set the mode.

Modulation Accuracy (Rho) - Meas Offset

```
:CALCulate:RHO:SWEep:OFFSet <integer>
:CALCulate:RHO:SWEep:OFFSet?
```

Set the timing offset of capture interval in slots. (1 slot = 666.6 us) If Capture Interval is 1slot, Meas Offset is fixed as “0”.

Notes	Min:0, Max: limited by Capture Interval – 1 in slot. SCPI Resolution:1
Preset	0
State Saved	Saved in instrument state.
SCPI Resolution	1
Key Path	Meas Setup

Marker Commands

Marker to trace - Mod Accuracy

:CALCulate:RHO:MARKer:TRACe CDPower | EVM | MERRor | PERRor

:CALCulate:RHO:MARKer:TRACe?

Sets the active marker.

Setup	:CONF:RHO
Dependencies and Couplings	No
Preset	EVM
State Saved	Saved in instrument state.
Range	CDPower EVM MERRor PERRor
Key Path	Marker, Trace

Baseband I/Q - Spectrum I/Q Marker Query

:CALCulate:SPECTrum:MARKer:IQ [1] | 2 | 3 | 4?

Reads out current I and Q marker values.

Remarks: You must be in the Basic, W-CDMA, cdma2000, or EDGE with GSM mode to use this command. Use INSTRument:SElect to set the mode.

History: Added revision A.05.00 for B, WC, C2
Added revision A.06.00 for E

Baseband I/Q - Waveform I/Q Marker Query

:CALCulate:WAVEform:MARKer:IQ [1] | 2 | 3 | 4?

Reads out current I and Q marker values.

Remarks: You must be in the Basic, W-CDMA, cdma2000, or GSM with EDGE mode to use this command. Use INSTRument:SElect to set the mode.

History: Added revision A.05.00 for B, WC, C2
Added revision A.06.00 for E

CONFigure Subsystem

The CONFigure commands are used with several other commands to control the measurement process. The full set of commands are described in the section “[MEASure Group of Commands](#)” on page 654.

Selecting measurements with the CONFigure/FETCh/MEASure/READ commands sets the instrument state to the defaults for that measurement and to make a single measurement. Other commands are available for each measurement to allow you to change: settings, view, limits, etc. Refer to:

```
SENSe:<measurement>, SENSE:CHANnel, SENSE:CORRection,
SENSe:DEFaults, SENSE:DEViation, SENSE:FREQuency,
SENSe:PACKet, SENSE:POWEr, SENSE:RADio, SENSE:SYNC
CALCulate:<measurement>, CALCulate:CLIMits
DISPlay:<measurement>
TRIGger
```

The INITiate[:IMMediate] or INITiate:REStart commands will initiate the taking of measurement data without resetting any of the measurement settings that you have changed from their defaults.

Configure the Selected Measurement

```
:CONFigure:<measurement>
```

A CONFigure command must specify the desired measurement. It will set the instrument settings for that measurement’s standard defaults, but should not initiate the taking of data. The available measurements are described in the MEASure subsystem.

NOTE

If CONFigure initiates the taking of data, the data should be ignored. Other SCPI commands can be processed immediately after sending CONFigure. You do not need to wait for the CONF command to complete this 'false' data acquisition.

Configure Query

```
:CONFigure?
```

The CONFigure query returns the name of the current measurement.

DISPlay Subsystem

The DISPlay controls the selection and presentation of textual, graphical, and TRACe information. Within a DISPlay, information may be separated into individual WINDows.

Adjacent Channel Power - View Selection

```
:DISPlay:ACP:VIEW BGRaph|SPECTrum
```

```
:DISPlay:ACP:VIEW?
```

Select the adjacent channel power measurement display of bar graph or spectrum.

You may want to disable the spectrum trace data part of the measurement so you can increase the speed of the rest of the measurement display. Use SENSE:ACP:SPECTrum:ENABLE to turn on or off the spectrum trace. (Basic and cdmaOne modes only)

Factory Preset: Bar Graph (BGRaph)

Remarks: For E4406A you must be in the Basic, cdmaOne, cdma2000, W-CDMA, NADC or PDC mode to use this command. Use INSTRument:SElect to set the mode.

For PSA you must be in the cdmaOne, cdma2000, W-CDMA, NADC or PDC mode to use this command. Use INSTRument:SElect to set the mode.

Key Path: **ACP, View/Trace**

Code Domain - View Selection

```
:DISPlay:CDPower:VIEW PGRaph|SEVM|QUAD|DBITs|CDE
```

```
:DISPlay:CDPower:VIEW?
```

Allows you to select the desired measurement view from the following selections:

PGRaph – (Power Graph & Metrics) provides a combination view of the code domain power graph and the summary data. Not available if the [:SENSe]:CDPower:CAPTure:TIME(Capture Interval) is 4.0, 8.0 or 16.0(Long Mode).

SEVM – (I/Q Error (Quad View) - Symbol EVM) provides a combination view of magnitude error, phase error, Symbol EVM, and the summary data. Not available if the [:SENSe]:CDPOwer:CAPTure:TIME(Capture Interval) is set to 4.0 or 8.0(Long Mode).

QUAD – (Code Domain (Quad View)) provides a combination view for the code domain power symbol power, I/Q symbol polar vector and the summary data. Not available if the [:SENSe]:CDPOwer:CAPTure:TIME(Capture Interval) is set to 4.0 or 8.0(Long Mode).

DBITs – (Demod Bits) provides a combination view of the graphs for the code domain power and symbol power, and the I/Q demodulated bit stream data for the symbol power slots selected by the measurement interval and measurement offset

CDE – (Power Graph & CDE Graph) provides a combination view of the code domain power graph and the code domain error. Not available if the [:SENSe]:CDPOwer:CAPTure:TIME(Capture Interval) is 4.0 or 8.0 or 16.0(Long Mode).

Example	:DISPlay:CDPower:VIEW PGRaph
Preset	PGRaph
State Saved	Saved in instrument state.
Range	Power Graph & Metrics I/Q Error (Quad View) Code Domain (Quad View) Demod Bits Power Graph & CDE Graph
Key Path	View/Trace

Turn the Display On/Off

:DISPlay:ENABle OFF|ON|0|1

:DISPlay:ENABle?

Controls the display. If enable is set to off, the display is turned off. For E4406A, if enable is set to off, the display will appear to “freeze” in its current state. Measurements may run faster since the instrument doesn’t have to update the display after every data acquisition. There is often no need to update the display information when using remote operation. Turning the display off will also extend its life and reduce EMI. An instrument preset will turn the display back on.

Factory Preset: On

Remarks: The following key presses will turn display enable back on:

1. If in local, press any key
2. If in remote, press the local (system) key
3. If in local lockout (SYST:KLOCK), no key press will work

Key Path:

Access

(for E4406A): **System, Disp Updates**

Select Display Format

:DISPlay:FORMat:ZOOM

Selects the viewing format that displays only one window of the current measurement data (the current active window). Use DISP:FORM:TILE to return the display to multiple windows.

Remarks: For PSA you must be in the Basic, cdmaOne, cdma2000, 1xEV-DO, W-CDMA, GSM (w/EDGE), NADC, or PDC mode to use this command. Use INSTRument:SElect to set the mode

Key Path: **Zoom** (toggles between Tile and Zoom)

Full Screen Display

`:DISPlay:FSCReen[:STATe] OFF|ON|0|1`

`:DISPlay:FSCReen[:STATe]?`

For Noise Figure Mode only:

`:DISPlay:FSCREEN|FULLSCREEN[:STATe] ON|OFF|1|0`

`:DISPlay:FSCREEN|FULLSCREEN[:STATe]?`

When the full screen function is activated, the measurement window expands horizontally over the entire instrument display. That is, it turns off the display of the softkey labels. Pressing any other key that results in a new menu will cancel the full screen function.

State Saved: Not saved in state.

Factory Preset: Off

Factory
 Default: Off

Key Path: **Display**

Example: `DISP:FSCR ON`

History: PSA: Added with firmware revision A.02.00

PCON (Power Control) - W-CDMA

PCON View Phase/Power Trace

```
:DISPlay:PCONtrol:VIEW POWER | PHASe
```

```
:DISPlay:PCONtrol:VIEW?
```

Allows the user to select the results view.

Example	:DISPlay:PCONtrol:VIEW PHASe
Notes	The choices are available only if Meas Type selection is Slot Phase. Otherwise, the choices are grayed out. The default value is PHASe to make it easy to access Phase Error view of Slot Phase measurement.
Preset	POWer
State Saved	Saved in instrument state.
Range	POWer PHASe
Key Path	Trace/View

PVT - Limit Mask Display

```
:DISPlay:PVTTime:LIMit:MASK OFF | ON | 0 | 1
```

```
:DISPlay:PVTTime:LIMit:MASK?
```

Turns on/off the display function of the limit mask lines. It also controls the limit checking function.

See also [:SENS]:PVT:LIM:MASK.

Factory Preset: ON

Remarks: You must be in GSM, EDGE, 1xEV-DO or W-CDMA mode to use this command. Use INSTRUMENT:SElect to set the mode.

Key Path: **Power vs Time, Display**

PVT - View Selection

iDEN, WiDEN mode

```
:DISPlay:PVTTime:VIEW ALL|BOTH
```

All other modes

```
:DISPlay:PVTTime:VIEW ALL|BOTH|A|B|C|D|E
```

```
:DISPlay:PVTTime:VIEW?
```

Select one of the power versus time measurement result views as follows:

ALL - displays the whole burst waveform throughout the all regions.

BOTH - displays both the rising and falling edges expanded in the horizontal scale.

A - display only the A region in the full horizontal scale. (not available in iDEN or WiDEN)

B - display only the B region in the full horizontal scale. (not available in iDEN or WiDEN)

C - display only the C region in the full horizontal scale. (not available in iDEN or WiDEN)

D - display only the D region in the full horizontal scale. (not available in iDEN or WiDEN)

E - display only the E region in the full horizontal scale. (not available in iDEN or WiDEN)

Factory Preset: ALL

Remarks: You must be in the 1xEV-DO, iDEN, WiDEN, or W-CDMA mode to use this command. Use INSTRUMENT:SElect to set the mode.

Key Path: **Power vs Time, View/Trace**

Modulation Accuracy (Rho) - View Selection

```
:DISPlay:RHO:VIEW ERROR | POLar | PGRaph | TABLE | SUMMary | CDERror  
:DISPlay:RHO:VIEW?
```

Allows you to select the desired measurement view from the following selections:

I/Q Measured Polar Graph - Provides a combination view of an I/Q measured polar vector graph and the summary data as shown below.

I/Q Error (Tri View) - Provides a combination view of a magnitude error, phase error, EVM graphs.

Code Domain Power - Provides a graph Modulation Accuracy (Rho) channels individual power in dB with an I/Q Measured Polar Graph. A table of summary data for the Modulation Accuracy (Rho) channels is provided in the text window.

Peak/Average Metrics - Provides a table of magnitude error, phase error, EVM, and the modulation accuracy summary data such as rho, peak and rms EVM, peak Modulation Accuracy (Rho) error, magnitude error, phase error, and so forth in a text window, in terms of averaged and detected peak/maximum value in the average cycle.

Capture Time Summary – Provides a table of the summary for the measurement result through Capture Interval. Hilighting the peak/worst result through Capture Interval slot-by-slot.

Slot CDE/EVM(Tri View) – Provides a combination view of a Frequency Error, Peak CDE, EVM graph.

Preset	POLar
State Saved	Saved in instrument state.
Range	I/Q Measured Polar Graph I/Q Error (Quad View) Code Domain Power Results Mertics
Key Path	View/Display

Spectrum - Y-Axis Scale/Div

```
:DISPlay:SPECTrum[n]:WINDow[m]:TRACe:Y[:SCALe]:PDIVision
<power>
```

```
:DISPlay:SPECTrum[n]:WINDow[m]:TRACe:Y[:SCALe]:PDIVision?
```

Sets the scale per division for the y-axis.

n – selects the view, the default is Spectrum.

m – selects the window within the view. The default is 1.

— n=1, m=1 Spectrum

— n=1, m=2 I/Q Waveform

— n=1, m=2 I and Q Waveform (Basic, W-CDMA, cdma2000)

— n=1, m=3 numeric data (Service mode, E4406A only)

— n=1, m=4 RF envelope (Service mode, E4406A only)

— n=2, m=1 I Waveform (Option B7C, E4406A only)

— n=2, m=2 Q Waveform (Option B7C, E4406A only)

— n=3, m=1 I/Q Polar (Basic, W-CDMA, cdma2000)

— n=4, m=1 Linear Spectrum (Basic, W-CDMA, cdma2000)

Factory Preset: 10 dB per division, for Spectrum

100 mV per division, for I/Q Waveform

Range: 0.1 dB to 20 dB per division, for Spectrum

1 nV to 20 V per division, for I/Q Waveform

Default Unit: 10 dB per division, for Spectrum

Remarks: May affect input attenuator setting.

For E4406A to use this command, the appropriate mode should be selected with INSTRUMENT:SElect.

For PSA you must be in Basic, cdmaOne, cdma2000, 1xEV-DO, W-CDMA GSM w/EDGE, NADC, or PDC mode. Set the mode with INSTRUMENT:SElect.

Key Path: When in Spectrum measurement: **Amplitude Y Scale, Scale/Div.**

History: For PSA:
 Added revision A.02.00

For E4406A:
 Modified revision A.05.00

Spectrum - Y-Axis Reference Level

```
:DISPlay:SPECTrum[n] :WINDow[m] :TRACe:Y[:SCALe] :RLEVel  
<power>
```

```
:DISPlay:SPECTrum[n] :WINDow[m] :TRACe:Y[:SCALe] :RLEVel?
```

Sets the amplitude reference level for the y-axis.

n, selects the view, the default is RF envelope.

— n=1, m=1 Spectrum

— n=1, m=2 I/Q Waveform

— n=1, m=2 I and Q Waveform (Basic, W-CDMA, cdma2000)

— n=1, m=3 numeric data (Service mode, E4406A only)

— n=1, m=4 RF envelope (Service mode, E4406A only)

— n=2, m=1 I Waveform (Option B7C, E4406A only)

— n=2, m=2 Q Waveform (Option B7C, E4406A only)

— n=3, m=1 I/Q Polar (Basic, W-CDMA, cdma2000)

— n=4, m=1 Linear Spectrum (Basic, W-CDMA, cdma2000)

m – selects the window within the view. The default is 1.

Factory Preset: 0 dBm, for Spectrum

Range: –250 to 250 dBm, for Spectrum

Default Unit: dBm, for Spectrum

Remarks: May affect input attenuator setting.

For E4406A to use this command, the appropriate mode should be selected with INSTRUMENT:SElect.

For PSA you must be in Basic, cdmaOne, cdma2000, 1xEV-DO, W-CDMA GSM w/EDGE, NADC, or PDC mode. Set the mode with INSTRUMENT:SElect.

Key Path: When in Spectrum measurement: **Amplitude Y Scale, Ref Level**

History: For PSA:
Added revision A.02.00

For E4406A:
Modified revision A.05.00

Turn a Trace Display On/Off

:DISPlay:TRACe [n] [:STATe] OFF|ON|0|1

:DISPlay:TRACe [n] [:STATe] ?

Controls whether the specified trace is visible or not.

n is a sub-opcode that is valid for the current measurement. See the “[MEASure Group of Commands](#)” on page 654 for more information about sub-opcodes.

Factory Preset: On

Range: The valid traces and their sub-opcodes are dependent upon the selected measurement. See the following table.

The trace name assignment is independent of the window number.

Remarks: For E4406A to use this command, the appropriate mode should be selected with **INSTRument:SElect**.

Remarks: For PSA you must be in the Basic, cdmaOne, cdma2000, 1xEV-DO, W-CDMA, GSM (w/EDGE), NADC, or PDC mode to use this command. Use **INSTRument:SElect** to set the mode

Key Path: **Display, Display Traces**

Measurement	Available Traces	Markers Available?
ACP - adjacent channel power (Basic, cdmaOne, cdma2000, W-CDMA, iDEN (E4406A only), WiDEN (E4406A only), NADC, PDC modes)	no traces (<i>n=0</i>) ^a for I/Q points	no markers
BER - bit error rate (iDEN, WiDEN mode, E4406A only)	no traces (<i>n=0</i>) ^a for I/Q data	no markers
CDPower - code domain power (cdmaOne mode)	POWer (<i>n=2</i>) ^a TIMing (<i>n=3</i>) ^a PHASe (<i>n=4</i>) ^a (<i>n=0</i>) ^a for I/Q points	yes

Measurement	Available Traces	Markers Available?
CDPower - code domain power (cdma2000, 1xEV-DO, W-CDMA modes)	($n=0$) ^a for I/Q raw data CDPower ($n=2$) ^a EVM ($n=5$) ^a MERRor ($n=6$) ^a PERRor ($n=7$) ^a SPOWer ($n=9$) ^a CPOWer ($n=10$) ^a	yes
CHPower - channel power (Basic, cdmaOne, cdma2000, 1xEV-DO, W-CDMA modes)	SPECtrum ($n=2$) ^a ($n=0$) ^a for I/Q raw data	no markers
CSPur - spurs close (cdmaOne mode)	SPECtrum ($n=2$) ^a ULIMit ($n=3$) ^a ($n=0$) ^a for I/Q points	yes
EEVM - EDGE error vector magnitude (EDGE mode)	EVMerror ($n=2$) ^a MERRor ($n=3$) ^a PERRor ($n=4$) ^a ($n=0$) ^a for I/Q points	yes
EORFspectr - EDGE output RF spectrum (EDGE mode)	RFEMod ($n=2$) ^a RFESwitching ($n=3$) ^a SPEMod ($n=4$) ^a LIMMod ($n=5$) ^a ($n=0$) ^a for I/Q points	yes, only for a single offset yes, only for multiple offsets
EPVTime - EDGE power versus time (EDGE mode)	RFENvelope ($n=2$) ^a UMASk ($n=3$) ^a LMASk ($n=4$) ^a ($n=0$) ^a for I/Q points	yes

Measurement	Available Traces	Markers Available?
ETSPur - EDGE transmit band spurs (EDGE mode)	SPECTrum ($n=2$) ^a ULIMit ($n=3$) ^a ($n=0$) ^a for I/Q points	yes
EVM - error vector magnitude (NADC, PDC modes)	EVM ($n=2$) ^a MERRor ($n=3$) ^a PERRor ($n=4$) ^a ($n=0$) ^a for I/Q points	yes
EVMQpsk - QPSK error vector magnitude (cdma2000, 1xEV-DO, W-CDMA modes)	EVM ($n=2$) ^a MERRor ($n=3$) ^a PERRor ($n=4$) ^a ($n=0$) ^a for I/Q raw data	yes
IM - intermodulation (cdma2000, 1xEV-DO, W-CDMA modes)	SPECTrum ($n=2$) ^a ($n=0$) ^a for I/Q raw data	yes
MCPower - multi-carrier power (W-CDMA mode)	no traces ($n=0$) ^a for I/Q points	no markers
OBW - occupied bandwidth (cdmaOne, cdma2000, 1xEV-DO, iDEN (E4406A only), WiDEN (E4406A only), PDC, W-CDMA modes)	no traces ($n=0$) ^a for I/Q raw data	no markers
ORFSpectrum - output RF spectrum (GSM, EDGE mode)	RFEMod ($n=2$) ^a RFESwitching ($n=3$) ^a SPEMod ($n=4$) ^a LIMMod ($n=5$) ^a ($n=0$) ^a for I/Q points	yes, only for a single offset yes, only for multiple offsets
PFERror - phase and frequency error (GSM, EDGE mode)	PERRor ($n=2$) ^a PFERror ($n=3$) ^a RFENvelope ($n=4$) ^a ($n=0$) ^a for I/Q points	yes

Measurement	Available Traces	Markers Available?
PStAtistic - power statistics CCDF (Basic, cdma2000, 1xEV-DO, W-CDMA modes)	MEASured ($n=2$) ^a GAUSian ($n=3$) ^a REFerence ($n=4$) ^a ($n=0$) ^a for I/Q points	yes
PVTime - power versus time (GSM, EDGE, 1xEV-DO, Service (E4406A only) modes)	($n=0$) ^a for I/Q raw data RFENvelope ($n=2$) ^a UMASk ($n=3$) ^a LMASk ($n=4$) ^a	yes
RHO - modulation quality (cdmaOne, cdma2000, W-CDMA mode)	($n=0$) ^a for I/Q raw data EVM ($n=2$) ^a MERRor ($n=3$) ^a PERRor ($n=4$) ^a ($n=5$) ^a for I/Q corrected trace data	yes
RHO - modulation quality (1xEV-DO mode)	($n=0$) ^a for I/Q raw data ($n=1$) ^a for various summary results EVM ($n=2$) ^a MERRor ($n=3$) ^a PERRor ($n=4$) ^a ($n=5$) ^a for I/Q corrected trace data	yes
SEMAsk - spectrum emissions mask (cdma2000, 1xEV-DO, W-CDMA mode)	SPECtrum ($n=2$) ^a ($n=0$) ^a for I/Q raw data	yes
TSPur - transmit band spurs (GSM, EDGE mode)	SPECtrum ($n=2$) ^a ULIMit ($n=3$) ^a ($n=0$) ^a for I/Q points	yes

Measurement	Available Traces	Markers Available?
TXPower - transmit power (GSM, EDGE mode)	RFENvelope ($n=2$) ^a IQ ($n=8$) ^a ($n=0$) ^a for I/Q points	yes
SPECTrum - (frequency domain) (all modes)	RFENvelope ($n=2$) ^a for Service mode (E4406A only) IQ ($n=3$) ^a SPECTrum ($n=4$) ^a ASPectrum ($n=7$) ^a ($n=0$) ^a for I/Q raw data	yes
WAVEform - (time domain) (all modes)	RFENvelope ($n=2$) ^a (also for Signal Envelope trace) IQ ($n=5$) ^a ($n=0$) ^a for I/Q raw data	yes

a. The n number indicates the sub-opcode that corresponds to this trace. Detailed descriptions of the trace data can be found in the MEASure subsystem documentation by looking up the sub-opcode for the appropriate measurement.

Waveform - Y-Axis Scale/Div

```
:DISPlay:WAVeform[n] :WINDow[m] :TRACe:Y[:SCALe] :PDIVision  
<power>
```

```
:DISPlay:WAVeform[n] :WINDow[m] :TRACe:Y[:SCALe] :PDIVision?
```

Sets the scale per division for the y-axis.

n, selects the view, the default is RF envelope.

n=1, m=1 RF envelope

n=2, m=1 I/Q Waveform

n=2, m=1 I and Q Waveform (Option B7C, E4406A only)

n=4, m=1 I/Q Polar (Basic, W-CDMA, cdma2000)

n=5, m=1 Linear Envelope (Option B7C, E4406A only)

m, selects the window within the view. The default is 1.

Factory Preset: 10 dBm, for RF envelope

Range: .1 dB to 20 dB, for RF envelope

Default Unit: dBm, for RF envelope

Remarks: May affect input attenuator setting.

For E4406A to use this command, the appropriate mode should be selected with INSTRUMENT:SElect.

For PSA you must be in Basic, cdmaOne, cdma2000, 1xEV-DO, W-CDMA GSM w/EDGE, NADC, or PDC mode. Set the mode with INSTRUMENT:SElect.

Key Path: When in Waveform measurement: **Amplitude Y Scale, Scale/Div.**

History: For PSA:
Added revision A.02.00

For E4406A:
Modified revision A.05.00

Waveform - Y-Axis Reference Level

```
:DISPlay:WAVeform [n] :WINDow [m] :TRACe:Y[:SCALE] :RLEVEL
<power>
```

```
:DISPlay:WAVeform [n] :WINDow [m] :TRACe:Y[:SCALE] :RLEVEL?
```

Sets the amplitude reference level for the y-axis.

n, selects the view, the default is RF envelope.

n=1, m=1 RF envelope

n=2, m=1 I/Q Waveform

n=2, m=1 I and Q Waveform (Option B7C, E4406A only)

n=4, m=1 I/Q Polar (Basic, W-CDMA, cdma2000)

n=5, m=1 Linear Envelope (Option B7C, E4406A only)

m, selects the window within the view. The default is 1.

Factory Preset: 0 dBm, for RF envelope

Range: -250 to 250 dBm, for RF envelope

Default Unit: dBm, for RF envelope

Remarks: May affect input attenuator setting.

For E4406A to use this command, the appropriate mode should be selected with INSTRUMENT:SElect.

For PSA you must be in Basic, cdmaOne, cdma2000, 1xEV-DO, W-CDMA GSM w/EDGE, NADC, or PDC mode. Set the mode with INSTRUMENT:SElect.

Key Path: When in Waveform measurement: **Amplitude Y Scale, Ref Level**

History: For PSA:
 Added revision A.02.00

For E4406A:
 Modified revision A.05.00

Window Focus Move Control

`:DISPlay:WINDow[:SElect] <number>`

`:DISPlay:WINDow[:SElect] ?`

Move window focus to specified window (1 to 4). Window selection depends on currently available views.

Factory Preset: 1

Range: Window dependant

Remarks: You must be in the W-CDMA mode to use this command. Use INSTRument:SElect to set the mode.

Window Selection

`:DISPlay:WINDow:SElect 1|2|3|4`

`:DISPlay:WINDow:SElect?`

Sets the active window.

Notes	Window selection is performed front panel using the 'Next Window' hardkey.
Dependencies and Couplings	Changing the selected window changes the value displayed on the Window Content softkey. The 'green border' round the window shows the active window.
Preset	1
State Saved	No
Range	1 2 3 4

X-Scale Commands

The following X-scale operations can be used to graphical display (window) for all measurements except Spectrum and Waveform.

X-Axis Couple Control

```
:DISPlay:WINDow [1] | 2 | 3 | 4 :TRACe:X[:SCALe] :COUPLe 0 | 1 | Off | On
:DISPlay:WINDow [1] | 2 | 3 | 4 :TRACe:X[:SCALe] :COUPLe?
```

Turn the couple mode for the x-axis On or Off.

Example	:DISPlay:WINDow:TRACe:X:SCALe:COUPLe ON
Notes	Upon pressing the Restart front-panel key or Restart softkey under the Meas Control menu, the scale coupling function automatically determines the scale per division and reference values based on the measurement results if this parameter is set to On. When you set a value to either Scale/Div or Ref Value manually, Scale Coupling automatically changes to Off.
Dependencies and Couplings	See Restriction and Notes
Preset	1
State Saved	Saved in instrument state.
Range	On Off
Key Path	SPAN/X Scale
Remarks:	You must be in the W-CDMA mode to use this command. Use INSTRument:SELEct to set the mode.

X-Axis Scale/Div

```
:DISPlay:WINDow[1] | 2 | 3 | 4:TRACe:X[:SCALe]:PDIVision <number>  
:DISPlay:WINDow[1] | 2 | 3 | 4:TRACe:X[:SCALe]:PDIVision?
```

Set the scale per division for the x-axis.

Example :DISPlay:WINDow:TRACe:X:SCALe:PDIVision
 4.0e-3

Notes If the Scale Coupling default is On, this value is automatically determined by the measurement result. When you set a value manually, Scale Coupling automatically changes to Off.

Dependencies and Couplings See Restriction and Notes

Preset 4.000 ms

State Saved Saved in instrument state.

SCPI Resolution 0.1 ns

Key Path **SPAN/X Scale**

Front-panel ns | us | ms | s
Unit/Terminator Keys

Range: Window dependant

Remarks: You must be in the W-CDMA mode to use this command. Use INSTRument:SElect to set the mode.

X-Axis Reference Level

:DISPlay:WINDow [1] | 2 | 3 | 4 :TRACe:X[:SCALe]:RLEVel <number>

:DISPlay:WINDow [1] | 2 | 3 | 4 :TRACe:X[:SCALe]:RLEVel?

Set the reference level for the x-axis.

Example :DISPlay:WINDow:TRACe:X:SCALe:RLEVel 0.0

Notes If the Scale Coupling default is On, this value is automatically determined by the measurement result. When you set a value manually, Scale Coupling automatically changes to Off.

Dependencies and Couplings See Restriction and Notes

Preset 0.0 s

State Saved Saved in instrument state.

SCPI Resolution 1.0 us

Key Path **SPAN/X Scale**

Front-panel Unit/Terminator Keys ns | us | ms | s

Range: Window dependant

Remarks: You must be in the W-CDMA mode to use this command. Use INSTRument:SElect to set the mode.

X-Axis Reference Position

`:DISPlay:WINDow[1] | 2 | 3 | 4:TRACe:X[:SCALe]:RPOSition <number
0.0 to 10.0>`

`:DISPlay:WINDow[1] | 2 | 3 | 4:TRACe:X[:SCALe]:RPOSition?`

Set the point on the x-axis to be used as the reference position.

0.0: Left, 5.0: Center, 10.0:Right

Example `:DISPlay:WINDow:TRACe:X:SCALe:RPOSition
0.0`

Preset 0.0

State Saved Saved in instrument state.

SCPI Resolution 5.0

Range: 0.0 to 10.0

Remarks: You must be in the W-CDMA mode to use this
command. Use `INSTrument:SELEct` to set the mode.

Y-Scale Commands

The following Y-scale operations can be used to graphical display
(window) for all measurements except Spectrum and Waveform.

Y-Axis Couple Control

`:DISPlay:WINDow[1] | 2 | 3 | 4:TRACe:Y[:SCALe]:COUPlE 0 | 1 | Off | On`

`:DISPlay:WINDow[1] | 2 | 3 | 4:TRACe:Y[:SCALe]:COUPlE?`

Turn the couple mode for the y-axis On or Off.

Example `:DISPlay:WINDow:TRACe:Y:SCALe:COUPlE ON`

Notes Upon pressing the Restart front-panel key or
Restart softkey under the Meas Control menu, the
scale coupling function automatically determines
the scale per division and reference values based
on the measurement results if this parameter is
set to On. When you set a value to either
Scale/Div or Ref Value manually, Scale Coupling
automatically changes to Off.

Dependencies and Couplings See Restriction and Notes

Preset	1
State Saved	Saved in instrument state.
Range	On Off
Key Path	AMPLITUDE/Y Scale
Remarks:	You must be in the W-CDMA mode to use this command. Use INSTRument:SElect to set the mode.

Y-Axis Scale/Div

`:DISPlay:WINDow [1] | 2 | 3 | 4:TRACe:Y[:SCALe]:PDIVision <number>`

`:DISPlay:WINDow [1] | 2 | 3 | 4:TRACe:Y[:SCALe]:PDIVision?`

Set the scale per division for the y-axis.

Example	<code>:DISPlay:WINDow:TRACe:Y:SCALe:PDIVision 10.0</code>
Notes	If the Scale Coupling default is On, this value is automatically determined by the measurement result. When you set a value manually, Scale Coupling automatically changes to Off.
Dependencies and Couplings	See Restriction and Notes
Preset	10.00 dB
State Saved	Saved in instrument state.
SCPI Resolution	0.00001 dB
Key Path	AMPLITUDE/Y Scale
Front-panel Unit/Terminator Keys	dB
Range:	Window dependant
Remarks:	You must be in the W-CDMA mode to use this command. Use INSTRument:SElect to set the mode.

Y-Axis Reference Level

:DISPlay:WINDow [1] | 2 | 3 | 4 :TRACe:Y[:SCALe]:RLEVel <number>

:DISPlay:WINDow [1] | 2 | 3 | 4 :TRACe:Y[:SCALe]:RLEVel?

Set the amplitude reference level for the y-axis.

Example :DISPlay:WINDow:TRACe:Y:SCALe:RLEVel 10.0

Notes If the Scale Coupling default is On, this value is automatically determined by the measurement result. When you set a value manually, Scale Coupling automatically changes to Off.

Dependencies and Couplings See Restriction and Notes

Preset 10.0 dBm

State Saved Saved in instrument state.

SCPI Resolution 0.0001 dBm

Key Path **AMPLITUDE/Y Scale**

Front-panel dBm
Unit/Terminator Keys

Range: Window dependant

Remarks: You must be in the W-CDMA mode to use this command. Use INSTRument:SELEct to set the mode.

Y-Axis Reference Position

`:DISPlay:WINDow[1] | 2 | 3 | 4:TRACe:Y[:SCALe]:RPOSition <number
 0.0 to 10.0>`

`:DISPlay:WINDow[1] | 2 | 3 | 4:TRACe:Y[:SCALe]:RPOSition?`

Set the point on the y-axis to be used as the reference position.

0.0: Bottom, 5.0: Center, 10.0:Top

Example `:DISPlay:WINDow:TRACe:Y:SCALe:RPOSition
 5.0`

Preset 5.0

State Saved Saved in instrument state.

SCPI Resolution 5.0

Factory Preset: Window dependant

Range: 0.0 to 10.0

Remarks: You must be in the W-CDMA mode to use this
 command. Use `INSTrument:SElect` to set the mode.

Y Scale/Div

`:DISPlay:WINDow:TRACe:Y[:SCALe]:PDIVision <real>`

`:DISPlay:WINDow:TRACe:Y[:SCALe]:PDIVision?`

Allows you to enter a numeric value to change the vertical display
 sensitivity.

Name: Y Scale/Div

Key Path: **AMPLITUDE/Y Scale**

Default degrees

Terminator:

Factory Preset: 50.0 degrees

State Saved: Saved in instrument state.

SCPI Resolution: 0.001 degrees

Dependencies and Couplings: None

Notes: If the Scale Coupling default is On, this value is automatically determined by the measurement result. When you set a value manually, Scale Coupling automatically changes to Off.

Example: :DISPlay:WINDow:TRACe:Y:SCALe:PDIVision 50.0

Y Ref Value

:DISPlay:WINDow:TRACe:Y[:SCALe]:RLEVel <real>

:DISPlay:WINDow:TRACe:Y[:SCALe]:RLEVel?

Allows you to set the absolute power reference.

Name:	Y Ref Value
Key Path:	AMPLITUDE/Y Scale
Default Terminator:	degrees
Factory Preset:	0.0 degrees
State Saved:	Saved in instrument state.
SCPI Resolution:	0.01 degrees
Dependencies and Couplings:	See Restriction and Notes None
Notes:	If the Scale Coupling default is On, this value is automatically determined by the measurement result. When you set a value manually, Scale Coupling automatically changes to Off.
Example:	:DISPlay:WINDow:TRACe:Y:SCALe:RLEVel 0.0

FETCh Subsystem

The FETCh? queries are used with several other commands to control the measurement process. These commands are described in the section on the “MEASure Group of Commands” on page 654. These commands apply only to measurements found in the MEASURE menu.

This command puts selected data from the most recent measurement into the output buffer (new data is initiated/measured). Use FETCh if you have already made a good measurement and you want to look at several types of data (different [n] values) from the single measurement. FETCh saves you the time of re-making the measurement. You can only fetch results from the measurement that is currently active.

If you need to make a new measurement, use the READ command, which is equivalent to an INITiate[:IMMEDIATE] followed by a FETCh.

:FETCh <meas>? will return valid data only when the measurement is in one of the following states:

- idle
- initiated
- paused

Fetch the Current Measurement Results

:FETCh: <measurement> [n] ?

A FETCh? command must specify the desired measurement. It will return the valid results that are currently available, but will not initiate the taking of any new data. You can only fetch results from the measurement that is currently selected. The code number n selects the kind of results that will be returned. The available measurements and data results are described in the “MEASure Group of Commands” on page 654.

FORMat Subsystem

The FORMat subsystem sets a data format for transferring numeric and array information. For PSA the TRACe[:DATA] command is affected by FORMat subsystem commands.

Byte Order

:FORMat:BORDER NORMAl | SWAPped

:FORMat:BORDER?

Selects the binary data byte order for numeric data transfer. In normal mode the most significant byte is sent first. In swapped mode the least significant byte is first. (PCs use the swapped order.) Binary data byte order functionality does not apply to ASCII.

Factory Preset: Normal

Remarks: You must be in the Basic, cdma2000, 1xEV-DO, W-CDMA, GSM (w/EDGE), NADC, or PDC mode to use this command. Use INSTRument:SElect to set the mode.

Numeric Data Format

PSA/VSA Basic, cdmaOne, cdma2000, 1xEV-DO, W-CDMA, GSM, EDGE, NADC, PDC modes:

:FORMat[:DATA] ASCii | REAL, 32 | REAL, 64

:FORMat[:DATA]?

PSA Spectrum Analysis mode only:

:FORMat[:TRACe][:DATA]

ASCii | INTeger, 16 | INTeger, 32 | REAL, 32 | REAL, 64 | UINTEger, 16

:FORMat[:TRACe][:DATA]?

PSA Noise Figure mode only:

:FORMat[:TRACe][:DATA] ASCii | REAL[, 32]

:FORMat[:TRACe][:DATA]?

VSA/PSA application modes: This command controls the format of data input/output, that is any data transfer across any remote port. The REAL and ASCII formats will format data in the current display units. The format of state data cannot be changed. It is always in a machine readable format only.

ASCII - Amplitude values are in ASCII, in amplitude units, separated by commas. ASCII format requires more memory than the binary formats. Therefore, handling large amounts of this type of data, will take more time and storage space.

Integer,16 - Binary 16-bit integer values in internal units (dBm), in a definite length block. PSA, SA mode only.

Integer,32 - Binary 32-bit integer values in internal units (dBm), in a definite length block.

Real,32 or Real,64 - Binary 32-bit (or 64-bit) real values in amplitude unit, in a definite length block. Transfers of real data are done in a binary block format.

UINTeger,16 - Binary 16-bit unsigned integer that is uncorrected ADC values, in a definite length block. This format is almost never applicable with current measurement data.

A definite length block of data starts with an ASCII header that begins with # and indicates how many additional data points are following in the block. Suppose the header is #512320.

- The first digit in the header (5) tells you how many additional digits/bytes there are in the header.
- The 12320 means 12 thousand, 3 hundred, 20 data bytes follow the header.
- Divide this number of bytes by your selected data format bytes/point, either 8 (for real 64), or 4 (for real 32). In this example, if you are using real 64 then there are 1540 points in the block.

Example: FORM REAL,64

Factory Preset: ASCII

Real,32 for Spectrum Analysis mode

ASCII for Basic, cdmaOne, cdma2000, 1xEV-DO, W-CDMA, GSM with EDGE, NADC, PDC modes

Remarks: The acceptable settings for this command change for the different modes as described above.

INITiate Subsystem

The INITiate subsystem is used to initiate a trigger for a measurement. They only initiate measurements from the MEASURE front-panel key or the “MEASure Group of Commands” on page 654. Refer to the TRIGger and ABORt subsystems for related commands.

Take New Data Acquisition for Selected Measurement

:INITiate:<measurement>

For PSA this command is not available for measurements in the instrument modes: Spectrum Analysis, or Phase Noise.

This command initiates a trigger cycle for the measurement specified, but does not return data. The available measurement names are described in the MEASure subsystem..

If your selected measurement is not currently active it will change to the measurement in your INIT:<meas> command and initiate a trigger cycle.

Example: INIT:ACP

Continuous or Single Measurements

:INITiate:CONTinuous OFF|ON|0|1

:INITiate:CONTinuous?

Selects whether a trigger is continuously initiated or not. Each trigger initiates a single, complete, measurement operation.

When set to ON another trigger cycle is initiated at the completion of each measurement.

When set to OFF, the trigger system remains in the “idle” state until an INITiate[:IMMEDIATE] command is received. On receiving the INITiate[:IMMEDIATE] command, it will go through a single trigger/measurement cycle, and then return to the “idle” state.

Example: INIT:CONT ON

Factory Preset: On

*RST: Off (recommended for remote operation)

Key Path: **Meas Control, Measure Cont Single**

Take New Data Acquisitions

:INITiate[:IMMediate]

The instrument must be in the single measurement mode. If INIT:CONT is ON, then the command is ignored. The desired measurement must be selected and waiting. The command causes the system to exit the “waiting” state and go to the “initiated” state.

The trigger system is initiated and completes one full trigger cycle. It returns to the “waiting” state on completion of the trigger cycle. Depending upon the measurement and the number of averages, there may be multiple data acquisitions, with multiple trigger events, for one full trigger cycle.

This command triggers the instrument, if external triggering is the type of trigger event selected. Otherwise, the command is ignored. Use the TRIGer[:SEquence]:SOURce EXT command to select the external trigger.

Example: INIT:IMM

Remarks: See also the *TRG command and the TRIGger subsystem.

Key Path: **Meas Control, Measure Cont Single**

Restart the Measurement

:INITiate:REStart

This command applies to measurements found in the MEASURE menu. It restarts the current measurement from the “idle” state regardless of its current operating state. It is equivalent to:

INITiate[:IMMediate]

ABORt (for continuous measurement mode)

Example: INIT:REST

Key Path: **Restart**

or

Meas Control, Restart

INSTRUMENT Subsystem

This subsystem includes commands for querying and selecting instrument measurement (personality option) modes.

Catalog Query

For E4406A, `:INSTRUMENT:CATALOG[:FULL]?`

For PSA, `:INSTRUMENT:CATALOG?`

Returns a comma separated list of strings which contains the names of all the installed applications. These names can only be used with the `INST:SELECT` command.

For E4406A if the optional keyword `FULL` is specified, each name is immediately followed by its associated instrument number. These instrument numbers can only be used with the `INST:NSELECT` command.

Example:

(PSA) `INST:CAT?`

Query response: "CDMA"4,"PNOISE"14

Example:

(E4406A) `INST:CAT:FULL?`

Query response:
"BASIC"8,"GSM"3,"CDMA"4,"SERVICE"1

Select Application by Number

`:INSTRUMENT:NSELECT <integer>`

`:INSTRUMENT:NSELECT?`

Select the measurement mode by its instrument number. The actual available choices depends upon which applications are installed in the instrument. For E4406A these instrument numbers can be obtained with `INST:CATALOG:FULL?`

- 1 = SA (PSA/ESA)
- 1 = SERVICE (E4406A)
- 3 = GSM (GSM on E4406A, and GSM or GSM w/EDGE on ESA)
- 4 = CDMA (cdmaOne) (E4406/ESA/PSA)
- 5 = NADC (E4406/PSA)
- 6 = PDC (E4406/PSA)
- 8 = BASIC (E4406/PSA)
- 9 = WCDMA (3GPP W-CDMA with HSDPA/HSUPA)(E4406/PSA)

- 10 = CDMA2K (cdma2000 with 1xEV-DV) (E4406/PSA)
- 11 = IDEN (E4406A)
- 13 = EDGE GSM (E4406/PSA)
- 14 = PNOISE (phase noise) (ESA/PSA)
- 15 = CMDA1XEV (1xEV-DO) (E4406/PSA)
- 18 = WLAN (PSA)
- 211 = TDSCDMA (PSA)
- 219 = NOISE FIGURE (ESA/PSA)
- 233 = MRECEIVE (PSA)
- 241 = DMODULATION (PSA)

NOTE

If you are using the SCPI status registers and the analyzer mode is changed, the status bits should be read, and any errors resolved, prior to switching modes. Error conditions that exist prior to switching modes cannot be detected using the condition registers after the mode change. This is true unless they recur after the mode change, although transitions of these conditions can be detected using the event registers.

Changing modes resets all SCPI status registers and mask registers to their power-on defaults. Hence, any event or condition register masks must be re-established after a mode change. Also note that the power up status bit is set by any mode change, since that is the default state after power up.

Example: INST:NSEL 4

Factory Preset: Persistent state with factory default of 1 (PSA)

Persistent state with factory default of 8
 (E4406A, BASIC)

Range: 1 to x, where x depends upon which applications are installed.

Key Path: **MODE**

Select Application

VSA E4406A:

```
:INSTrument [:SElect]
BASIC | SERVICE | CDMA | CDMA2K | GSM | EDGE GSM | IDEN | NADC
| PDC | WCDMA | CDMA1XEV | DMODULATION
```

PSA Series:

```
:INSTrument [:SElect]
SA | PNOISE | BASIC | CDMA | CDMA2K | EDGE GSM | NADC | PDC
| WCDMA | CDMA1XEV | NFIGURE | DMODULATION | WLAN | MRECEIVE
| TDSCDMA
```

```
:INSTrument [:SElect] ?
```

Select the measurement mode. The actual available choices depend upon which modes (measurement applications) are installed in the instrument. A list of the valid choices is returned with the INST:CAT? query.

Once an instrument mode is selected, only the commands that are valid for that mode can be executed.

- 1 = SA (PSA/ESA)
- 1 = SERVICE (E4406A)
- 3 = GSM (GSM on E4406A, and GSM or GSM w/EDGE on ESA)
- 4 = CDMA (cdmaOne) (E4406/ESA/PSA)
- 5 = NADC (E4406/PSA)
- 6 = PDC (E4406/PSA)
- 8 = BASIC (E4406/PSA)
- 9 = WCDMA (3GPP W-CDMA with HSDPA/HSUPA)(E4406/PSA)
- 10 = CDMA2K (cdma2000 with 1xEV-DV) (E4406/PSA)
- 11 = IDEN (E4406A)
- 13 = EDGE GSM (E4406/PSA)
- 14 = PNOISE (phase noise) (ESA/PSA)
- 15 = CMDA1XEV (1xEV-DO) (E4406/PSA)
- 18 = WLAN (PSA)
- 211 = TDSCDMA (PSA)
- 219 = NOISEFIGURE (ESA/PSA)
- 233 = MRECEIVE (PSA)
- 241 = DMODULATION (PSA)

NOTE

If you are using the status bits and the analyzer mode is changed, the status bits should be read, and any errors resolved, prior to switching modes. Error conditions that exist prior to switching modes cannot be detected using the condition registers after the mode change. This is true unless they recur after the mode change, although transitions of these conditions can be detected using the event registers.

Changing modes resets all SCPI status registers and mask registers to their power-on defaults. Hence, any event or condition register masks must be re-established after a mode change. Also note that the power up status bit is set by any mode change, since that is the default state after power up.

Example: ESA Series instruments: INST:SEL 'CDMA'

Example: PSA Series instruments: INST:SEL CDMA

Factory Preset:
(PSA) Persistent state with factory default of Spectrum Analyzer mode

Factory Preset:
(E4406A) Persistent state with factory default of Basic mode.

Key Path: **MODE**

MEASure Group of Commands

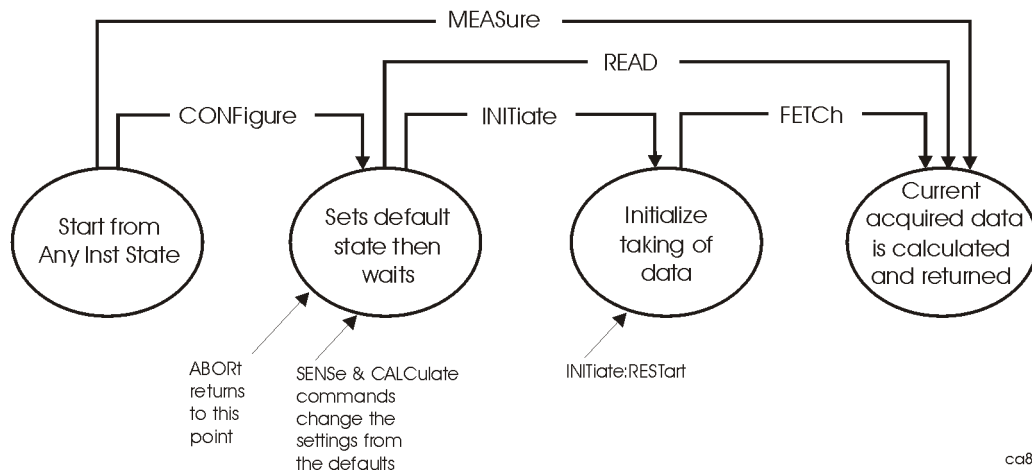
This group includes the CONFigure, FETCh, MEASure, and READ commands that are used to make measurements and return results. The different commands can be used to provide fine control of the overall measurement process, like changing measurement parameters from their default settings. Most measurements should be done in single measurement mode, rather than measuring continuously.

The SCPI default for the format of any data output is ASCII. The format can be changed to binary with FORMat:DATA which transports faster over the bus.

Command Interactions: MEASure, CONFigure, FETCh, INITiate and READ

Each one-button measurement has a group of commands that work together to make the measurement fast, but flexible.

Figure 1 Measurement Group of Commands



ca81a

Measure Commands:

:MEASure:<measurement> [n] ?

This is a fast single-command way to make a measurement using the factory default instrument settings. These are the settings and units that conform to the Mode Setup settings (e.g. radio standard) that you have currently selected.

- Stops the current measurement (if any) and sets up the instrument for the specified measurement using the factory defaults
- Initiates the data acquisition for the measurement
- Blocks other SCPI communication, waiting until the measurement is complete before returning results.
- If the function does averaging, it is turned on and the number of averages is set to 10.
- After the data is valid it returns the scalar results, or the trace data, for the specified measurement. The type of data returned may be defined by an [n] value that is sent with the command.

The scalar measurement results will be returned if the optional [n] value is not included, or is set to 1. If the [n] value is set to a value other than 1, the selected trace data results will be returned. See each command for details of what types of scalar results or trace data results are available.

ASCII is the default format for the data output. Older versions of Spectrum Analysis and Phase Noise mode measurements only use ASCII.) The binary data formats should be used for handling large blocks of data since they are smaller and faster than the ASCII format. Refer to the FORMat:DATA command for more information.

If you need to change some of the measurement parameters from the factory default settings you can set up the measurement with the CONFigure command. Use the commands in the SENSE:<measurement> and CALCulate:<measurement> subsystems to change the settings. Then you can use the READ? command to initiate the measurement and query the results. See [Figure 1](#).

If you need to repeatedly make a given measurement with settings other than the factory defaults, you can use the commands in the SENSE:<measurement> and CALCulate:<measurement> subsystems to set up the measurement. Then use the READ? command to initiate the measurement and query results.

Measurement settings persist if you initiate a different measurement and then return to a previous one. Use READ:<measurement>? if you want to use those persistent settings. If you want to go back to the default settings, use MEASure:<measurement>?.

Configure Commands:

:CONFigure: <measurement>

This command stops the current measurement (if any) and sets up the instrument for the specified measurement using the factory default instrument settings. It sets the instrument to single measurement mode but should not initiate the taking of measurement data unless INIT:CONTinuous is ON. If you change any measurement settings after using the CONFigure command, the READ command can be used to initiate a measurement without changing the settings back to their defaults. In Spectrum Analysis mode the CONFigure command also turns the averaging function on and sets the number of averages to 10 for all measurements.

In instruments with firmware older than A.05.00 CONFigure initiates the taking of data. This data should be ignored. Other SCPI commands can be processed immediately after sending CONFigure. You do not need to wait for the CONF command to complete this initial 'false' data acquisition.

The CONFigure? query returns the current measurement name.

Fetch Commands:

:FETCh: <measurement> [n] ?

This command puts selected data from the most recent measurement into the output buffer. Use FETCh if you have already made a good measurement and you want to return several types of data (different [n] values, e.g. both scalars and trace data) from a single measurement. FETCh saves you the time of re-making the measurement. You can only FETCh results from the measurement that is currently active, it will not change to a different measurement. An error is reported if a measurement other than the current one, is specified.

If you need to get new measurement data, use the READ command, which is equivalent to an INITiate followed by a FETCh.

The scalar measurement results will be returned if the optional [n] value is not included, or is set to 1. If the [n] value is set to a value other than 1, the selected trace data results will be returned. See each command for details of what types of scalar results or trace data results are available. The binary data formats should be used for handling large blocks of data since they are smaller and transfer faster than the ASCII format. (FORMat:DATA)

FETCh may be used to return results other than those specified with the original READ or MEASure command that you sent.

INITiate Commands:

:INITiate:<measurement>

This command is not available for measurements in all the instrument modes:

- Initiates a trigger cycle for the specified measurement, but does not output any data. You must then use the FETCh<meas> command to return data. If a measurement other than the current one is specified, the instrument will switch to that measurement and then initiate it.
 For example, suppose you have previously initiated the ACP measurement, but now you are running the channel power measurement. If you send INIT:ACP? it will change from channel power to ACP and will initiate an ACP measurement.
- Does not change any of the measurement settings. For example, if you have previously started the ACP measurement and you send INIT:ACP? it will initiate a new ACP measurement using the same instrument settings as the last time ACP was run.
- If your selected measurement is currently active (in the idle state) it triggers the measurement, assuming the trigger conditions are met. Then it completes one trigger cycle. Depending upon the measurement and the number of averages, there may be multiple data acquisitions, with multiple trigger events, for one full trigger cycle. It also holds off additional commands on GPIB until the acquisition is complete.

READ Commands:

:READ:<measurement> [n] ?

- Does not preset the measurement to the factory default settings. For example, if you have previously initiated the ACP measurement and you send READ:ACP? it will initiate a new measurement using the same instrument settings.
- Initiates the measurement and puts valid data into the output buffer. If a measurement other than the current one is specified, the instrument will switch to that measurement before it initiates the measurement and returns results.

For example, suppose you have previously initiated the ACP measurement, but now you are running the channel power measurement. Then you send READ:ACP? It will change from channel power back to ACP and, using the previous ACP settings, will initiate the measurement and return results.

- Blocks other SCPI communication, waiting until the measurement is complete before returning the results

If the optional [n] value is not included, or is set to 1, the scalar measurement results will be returned. If the [n] value is set to a value other than 1, the selected trace data results will be returned. See each command for details of what types of scalar results or trace data results are available. The binary data formats should be used when handling large blocks of data since they are smaller and faster than the ASCII format. (FORMat:DATA)

Current Measurement Query (Remote Command Only)

This command returns the name of the measurement that is currently running.

Remote Command: :CONFigure?
Example: CONF?

Test Current Results Against all Limits (Remote Command Only)

Queries the status of the current measurement limit testing. It returns a 0 if the measured results pass when compared with the current limits. It returns a 1 if the measured results fail any limit tests.

Remote Command: :CALCulate:CLIMits:FAIL?
Example: CALC:CLIM:FAIL?

Adjacent Channel Power Ratio (ACP) Measurement

For E4406A this measures the total rms power in the specified channel and in 5 offset channels. You must be in Basic, cdmaOne, cdma2000, W-CDMA, iDEN, NADC or PDC mode to use these commands. Use INSTRument:SElect to set the mode.

For PSA this measures the total rms power in the specified channel and in 5 offset channels. You must be in cdmaOne, cdma2000, W-CDMA, NADC or PDC mode to use these commands. Use INSTRument:SElect to set the mode.

The general functionality of CONFigure, FETCh, MEASure, and READ are described at the beginning of this section. See the SENSE:ACP commands for more measurement related commands.

```
:CONFigure:ACP
:INITiate:ACP
:FETCh:ACP [n] ?
:READ:ACP [n] ?
:MEASure:ACP [n] ?
```


For Basic mode, a channel frequency and power level can be defined in the command statement to override the default standard setting. A comma must precede the power value as a place holder for the frequency, when no frequency is sent.

History: E4406A:
 Added to Basic mode, version A.03.00 or later

Key Path: **Measure, ACP or ACPR**
 After the measurement is selected, press **Restore Meas Defaults** to restore factory defaults.

Measurement Results Available

Measurement Type	n	Results Returned
	0	Returns unprocessed I/Q trace data, as a series of trace point values, in volts. The I values are listed first in each pair, using the 0 through even-indexed values. The Q values are the odd-indexed values.
	n=1 (or not specified) NADC and PDC mode	Returns 22 scalar results, in the following order: 1. Center frequency – absolute power (dBm) 2. Center frequency – absolute power (W) 3. Negative offset frequency (1) – relative power (dB) 4. Negative offset frequency (1) – absolute power (dBm) 5. Positive offset frequency (1) – relative power (dB) 6. Positive offset frequency (1) – absolute power (dBm) . . . 1. Positive offset frequency (5) – relative power (dB) 2. Positive offset frequency (5) – absolute power (dBm)
	n=1 (or not specified) iDEN mode E4406A	Returns scalar results, in the following order: 1. Center frequency – relative power (dB) 2. Center frequency – absolute power (dBm) 3. Lower offset frequency – relative power (dB) 4. Lower offset freq– absolute power (dBm) 5. Upper offset frequency – relative power (dB) 6. Upper offset frequency – absolute power (dBm) 7. Total power (dBm) 8. Offset frequency (Hz) 9. Reference BW (Hz) 10. Offset BW (Hz) 11. Carrier/center frequency (Hz) 12. Frequency span (Hz) 13. Average count

Measurement Type	n	Results Returned
Total power reference	n=1 (or not specified) Basic, cdmaOne, cdma2000, W-CDMA mode	Returns 24 scalar results, in the following order: 1. Center frequency - relative power (dB) 2. Center frequency - absolute power (dBm) 3. Center frequency - relative power (dB) (same as value 1) 4. Center frequency - absolute power (dBm) (same as value 2) 5. Negative offset frequency (1) - relative power (dB), 6. Negative offset frequency (1) - absolute power (dBm) 7. Positive offset frequency (1) - relative power (dB) 8. Positive offset frequency (1) - absolute power (dBm) . . . 1. Positive offset frequency (5) - relative power (dB) 2. Positive offset frequency (5) - absolute power (dBm) <hr/> NOTE Center frequency relative power is relative to the center frequency absolute power and therefore, is always equal to 0.00 dB.
Power spectral density reference	n=1 (or not specified) Basic, cdmaOne, cdma2000, W-CDMA mode	Returns 24 scalar results, in the following order: 1. Center frequency - relative power (dB) 2. Center frequency - absolute power (dBm/Hz) 3. Center frequency - relative power (dB) (same as value 1) 4. Center frequency - absolute power (dBm/Hz) (same as value 2) 5. Negative offset frequency (1) - relative power (dB) 6. Negative offset frequency (1) - absolute power (dBm/Hz) 7. Positive offset frequency (1) - relative power (dB) 8. Positive offset frequency (1) - absolute power (dBm/Hz) . . . 1. Positive offset frequency (5) - relative power (dB) 2. Positive offset frequency (5) - absolute power (dBm/Hz) <hr/> NOTE Center frequency relative power is relative to the center frequency absolute power and therefore, is always equal to 0.00 dB.
	2 NADC and PDC mode	Returns 10 scalar values of the pass/fail (0=passed, or 1=failed) results determined by testing the absolute power of the offset frequencies: 1. Negative offset frequency (1) absolute power 2. Positive offset frequency (1) absolute power . . . 1. Negative offset frequency (5) absolute power 2. Positive offset frequency (5) absolute power

Measurement Type	n	Results Returned
	2 iDEN mode	Returns scalar values of the histogram absolute power trace: 1. Lower offset frequency – absolute power 2. Reference frequency – absolute power 3. Upper offset frequency – absolute power
Total power reference	2 Basic, cdmaOne, cdma2000, W-CDMA mode	Returns 11 scalar values (in dBm) corresponding to the total power histogram display. The values are returned in ascending frequency order: 1. Negative offset frequency (5) 2. Negative offset frequency (4) 3. Negative offset frequency (3) . . . 1. Center frequency 2. Positive offset frequency (1) 3. Positive offset frequency (2) . . . 1. Positive offset frequency (5)
	3 NADC and PDC mode	Returns 10 scalar values of the pass/fail (0=passed, or 1=failed) results determined by testing the relative power of the offset frequencies: 1. Negative offset frequency (1) relative power 2. Positive offset frequency (1) relative power . . . 1. Negative offset frequency (5) relative power 2. Positive offset frequency (5) relative power
	3 iDEN mode E4406A	Returns scalar values of the histogram relative power trace: 1. Lower offset frequency – relative power 2. Reference frequency – relative power 3. Upper offset frequency – relative power

Measurement Type	n	Results Returned
Power spectral density reference	3 Basic, cdmaOne, cdma2000, W-CDMA mode	Returns 11 scalar values (in dBm/Hz) corresponding to the power spectral density histogram display. The values are returned in ascending frequency order: 1. Negative offset frequency (5) 2. Negative offset frequency (4) . . . 1. Center frequency 2. Positive offset frequency (1) . . . 1. Positive offset frequency (5)
	4 NADC and PDC mode	Returns the frequency-domain spectrum trace (data array) for the entire frequency range being measured. In order to return spectrum data, the ACP display must be in the spectrum view and you must not turn off the spectrum trace.
	4 iDEN mode E4406A	Returns 4 absolute power values for the reference and offset channels. 1. Reference channel – absolute power 2. Reference channel – absolute power (duplicate of above) 3. Lower offset channel – absolute power 4. Upper offset channel – absolute power
(For cdma2000 and W-CDMA the data is only available with spectrum display selected)	4 Basic, cdmaOne, cdma2000, W-CDMA mode	Returns the frequency-domain spectrum trace data for the entire frequency range being measured. With the spectrum view selected (DISPlay:ACP:VIEW SPECTrum) and the spectrum trace on (SENSE:ACP:SPECTrum:ENABle): <ul style="list-style-type: none"> • In FFT mode (SENSE:ACP:SWEep:TYPE FFT) the number of trace points returned are 343 (cdma2000) or 1715 (W-CDMA). This is with the default span of 5 MHz (cdma2000) or 25 MHz (W-CDMA). The number of points also varies if another offset frequency is set. • In sweep mode (SENSE:ACP:SWEep:TYPE SWEep), the number of trace points returned is 601 (for cdma2000 or W-CDMA) for any span. With bar graph display selected, one point of –999.0 will be returned.

Measurement Type	n	Results Returned
	5 iDEN mode E4406A	Returns 4 relative power values for the reference and offset channels: <ol style="list-style-type: none"> 1. Reference channel – relative power 2. Reference channel – relative power (duplicate of above) 3. Lower offset channel – relative power 4. Upper offset channel – relative power
Total power reference	5 Basic, cdmaOne, cdma2000, W-CDMA mode	Returns 12 scalar values (in dBm) of the absolute power of the center and the offset frequencies: <ol style="list-style-type: none"> 1. Upper adjacent chan center frequency 2. Lower adjacent chan center frequency 3. Negative offset frequency (1) 4. Positive offset frequency (1) <p style="text-align: center;">. . .</p> <ol style="list-style-type: none"> 1. Negative offset frequency (5) 2. Positive offset frequency (5)
Power spectral density reference	5 Basic, cdmaOne, cdma2000, W-CDMA mode	Returns 12 scalar values (in dBm/Hz) of the absolute power of the center and the offset frequencies: <ol style="list-style-type: none"> 1. Upper adjacent chan center frequency 2. Lower adjacent chan center frequency 3. Negative offset frequency (1) 4. Positive offset frequency (1) <p style="text-align: center;">. . .</p> <ol style="list-style-type: none"> 1. Negative offset frequency (5) 2. Positive offset frequency (5)
	6 iDEN mode E4406A	Returns 4 pass/fail test results for the absolute power of the reference and offset channels: <ol style="list-style-type: none"> 1. Reference channel absolute power pass/fail 2. Reference channel absolute power pass/fail (duplicate of above) 3. Lower offset channel absolute power pass/fail 4. Upper offset channel absolute power pass/fail

Measurement Type	n	Results Returned
Total power reference	6 Basic, cdmaOne, cdma2000, W-CDMA mode	Returns 12 scalar values (total power in dB) of the power relative to the carrier at the center and the offset frequencies: 1. Upper adjacent chan center frequency 2. Lower adjacent chan center frequency 3. Negative offset frequency (1) 4. Positive offset frequency (1) 5. Negative offset frequency (5) . . . 1. Negative offset frequency (5) 2. Positive offset frequency (5)
Power spectral density reference	6 Basic, cdmaOne, cdma2000, W-CDMA mode	Returns 12 scalar values (power spectral density in dB) of the power relative to the carrier at the center and offset frequencies: 1. Upper adjacent chan center frequency 2. Lower adjacent chan center frequency 3. Negative offset frequency (1) 4. Positive offset frequency (1) . . . 1. Negative offset frequency (5) 2. Positive offset frequency (5)
	7 iDEN mode E4406A	Returns 4 pass/fail test results for the relative power of the reference and offset channels: 1. Reference channel relative power pass/fail 2. Reference channel relative power pass/fail (duplicate of above) 3. Lower offset channel relative power pass/fail 4. Upper offset channel relative power pass/fail
Total power reference	7 Basic, cdmaOne, cdma2000, W-CDMA mode	Returns 12 scalar values of the pass/fail (0=passed, or 1=failed) results determined by testing the absolute power limit of the center and offset frequencies (measured as total power in dB): 1. Upper adjacent chan center frequency 2. Lower adjacent chan center frequency 3. Negative offset frequency (1) 4. Positive offset frequency (1) . . . 1. Negative offset frequency (5) 2. Positive offset frequency (5)

Measurement Type	n	Results Returned
Power spectral density reference	7 Basic, cdmaOne, cdma2000, W-CDMA mode	Returns 12 scalar values of the pass/fail (0=passed, or 1=failed) results determined by testing the absolute power limit of the center and offset frequencies (measured as power spectral density in dB): 1. Upper adjacent chan center frequency 2. Lower adjacent chan center frequency 3. Negative offset frequency (1) 4. Positive offset frequency (1) . . . 1. Negative offset frequency (5) 2. Positive offset frequency (5)
Total power reference	8 Basic, cdmaOne, cdma2000, W-CDMA mode	Returns 12 scalar values of the pass/fail (0=passed, or 1=failed) results determined by testing the power limit relative to the center frequency (measured as total power spectral in dB): 1. Upper adjacent chan center frequency 2. Lower adjacent chan center frequency 3. Negative offset frequency (1) 4. Positive offset frequency (1) . . . 1. Negative offset frequency (5) 2. Positive offset frequency (5)
Power spectral density reference	8 Basic, cdmaOne, cdma2000, W-CDMA mode	Returns 12 scalar values of the pass/fail (0=passed, or 1=failed) results determined by testing the power limit relative to the center frequency (measured as power spectral density in dB): 1. Upper adjacent chan center frequency 2. Lower adjacent chan center frequency 3. Negative offset frequency (1) 4. Positive offset frequency (1) . . . 1. Negative offset frequency (5) 2. Positive offset frequency (5)

50 MHz Amplitude Reference Measurement

This aligns the internal 50 MHz reference signal to an external reference signal that you supply. You must be in the Service mode to use these commands. Use INSTRument:SElect to set the mode.

The general functionality of CONFigure, FETCh, MEASure, and READ are described at the beginning of this section. See the SENSE:AREference commands for more measurement related commands.

```
:CONFigure:AREference
:INITiate:AREference
:FETCh:AREference [n] ?
:READ:AREference [n] ?
:MEASure:AREference [n] ?
```

Remarks: For auto adjustment of the internal 50 MHz amplitude reference, use CALibration:AMPLitude:REFerence:AADJust command after this measurement has been selected.

Key Path: **Measure, 50 MHz Amptd**
 After the measurement is selected, press **Restore Meas Defaults** to restore factory defaults.

Measurement Results Available

n	Results Returned
n=1 (or not specified)	Returns scalar results: <ol style="list-style-type: none"> 1. RF input average amplitude 2. 50 MHz reference oscillator average amplitude 3. Average amplitude error 4. State (for factory use only) 5. Level (for factory use only) 6. Monitored level (for factory use only) 7. Connector status (for factory use only)
2	RF input amplitude trace data.
3	50 MHz oscillator amplitude trace data
4	Amplitude error strip chart trace data

Code Domain Power Measurement

This measures the power levels of the spread channels in RF channel(s). You must be in the cdmaOne, cdma2000, W-CDMA, or 1xEV-DO mode to use these commands. Use INSTRument:SElect to set the mode.

For 1xEV-DO, this measurement is used only for base stations (Network Access). When measuring 1xEV-DO mobile stations (Access Terminals) use Terminal Code Domain Measurements (MEAS:TCDPower) and set SENSE:RADio:DEvice to MS.

The general functionality of CONFigure, FETCh, MEASure, and READ are described at the beginning of this section. See the SENSE:CDPower commands for more measurement related commands.

:CONFigure:CDPower

:INITiate:CDPower

:FETCh:CDPower [n] ?

:READ:CDPower [n] ?

:MEASure:CDPower [n] ?

Key Path: **Measure, Code Domain**

After the measurement is selected, press **Restore Meas Defaults** to restore factory defaults.

Measurement Results Available

n	Results Returned
0	Raw Data. Returns unprocessed I/Q trace data, as a series of trace point values, in volts. The I values are listed first in each pair, using the 0 through even-indexed values. The Q values are the odd-indexed values.

n	Results Returned
n=1 (or not specified) cdmaOne mode	<p>Returns the following scalar results:</p> <ol style="list-style-type: none"> 1. Time offset is a floating point number with units of seconds. This is the time delay of the even second clock with respect to the start of the short code PN sequences, at offsets from the 15 zeros in the characteristic phase of the sequences. 2. Frequency error is a floating point number (in Hz) of the frequency error in the measured signal. This error is based on the linear best fit of the uncorrected measured phase. 3. Carrier feedthrough is a floating point number (in dB) of the dc offset, of I and Q, from the origin. 4. Pilot power is a floating point number with units of dB. It is the relative power of the pilot channel (Walsh code 0) with respect to the carrier power. 5. Paging power is a floating point number with units of dB. It is the relative power of the paging channel (Walsh code 1) with respect to the carrier power. 6. Sync power is a floating point number with units of dB. It is the relative power of the sync channel (Walsh code 32) with respect to the carrier power. 7. Average traffic power is a floating point number with units of dB. It is the average relative power of the active traffic channels with respect to the carrier power. Traffic channels are defined as all of the Walsh codes except Walsh 0,1,32. A traffic channel is active if its coding power is greater than the active threshold parameter which you have selected. 8. Maximum inactive traffic power is a floating point number with units of dB. It is the maximum relative power of an inactive traffic channel with respect to the carrier power. Traffic channels are defined as all of the Walsh codes except Walsh 0,1,32. A traffic channel is inactive if its coding power is less than the active threshold parameter which you have selected. 9. Average inactive traffic power is a floating point number with units of dB. It is the average relative power of the inactive traffic channels with respect to the carrier power. Traffic channels are defined as all of the Walsh codes except Walsh 0,1,32. A traffic channel is inactive if its coding power is less than the active threshold parameter which you have selected. 10. Marker Values The last 16 measurement results are the current values for all four available markers. The values are zero for any marker that is not active. <ol style="list-style-type: none"> 10. Marker 1 position (code number) 11. Marker 1 power level 12. Marker 1 time value 13. Marker 1 phase value . . . 25. Marker 4 phase value

n	Results Returned
n=1 (or not specified) cdma2000 mode	<p>Returns the following scalar results:</p> <ol style="list-style-type: none"> 1. RMS symbol EVM is a floating point number (in percent) of the EVM over the entire measurement area. 2. Peak symbol EVM is a floating point number (in percent) of the peak EVM in the measurement area. 3. Symbol magnitude error is a floating point number (in percent) of the average magnitude error over the entire measurement area. 4. Symbol phase error is a floating point number (in degrees) of the average phase error over the entire measurement area. 5. Total power is a floating point number (in dBm) of the total RF power over the measurement interval. 6. Channel power is a floating point number (in dBc or dBm depending on the measurement type, see below) of the power in the entire slot, for the selected code, averaged over the measurement interval. NOTE: When measurement type = rel, then the value displayed is in units of dBc, and the relative power is calculated as the ratio of the Channel Power to the Total Power (parameter 5 above). 7. Total active power is a floating point number (in dB or dBm depending on the measurement type) of the sum of the active power. 8. Pilot power is a floating point number (in dB or dBm depending on the measurement type) of the average power of the Pilot code. 9. Sync power is a floating point number (in dB or dBm depending on the measurement type) of the average power of the Sync code. In the MS mode, the value returned is -999. 10. Maximum active traffic power is a floating point number (in dB or dBm depending on the measurement type) of the maximum average power of the active code. If no active code is detected the value returned is -999. In the MS mode, the value returned is -999. 11. Average active traffic power is a floating point number (in dB or dBm depending on the measurement type) of the average power of all the active traffic channels. If no active code is detected the value returned is -999. In the MS mode, the value returned is -999. 12. Maximum inactive traffic power is a floating point number (in dB or dBm depending on the measurement type) of the maximum average power of the inactive traffic channels. In the MS mode, the value returned is -999. 13. Average inactive traffic power is a floating point number (in dB or dBm depending on the measurement type) of the average power of the inactive traffic channels. In the MS mode, the value returned is -999. 14. Number of active channel In the MS mode, the value returned is -999.

n	Results Returned
n=1 (or not specified) cdma2000 mode (continued)	<p>15. I channel average active power is a floating point number (in dB or dBm depending on the measurement type) of the average power of the active I channels. In the BS mode, the value returned is -999.</p> <p>16. I channel maximum inactive power is a floating point number (in dB or dBm depending on the measurement type) of the maximum average power of the inactive I channels. In the BS mode, the value returned is -999.</p> <p>17. Q channel average active power is a floating point number (in dB or dBm depending on the measurement type) of the average power of the active Q channels. In the BS mode, the value returned is -999.</p> <p>18. Q channel maximum inactive power is a floating point number (in dB or dBm depending on the measurement type) of the maximum average power of the inactive Q channels. In the BS mode, the value returned is -999.</p> <p>19. Time between trigger to PN Offset is a floating point number (in μs) of the time from the trigger point to the PN Offset. In the MS mode, the value returned is -999.</p> <p>20. Mod Scheme is available when 1xEV-DV demod enable is set to ON. It is an integer number that indicates the modulation type used in the specified channel and measurement time period. In the MS mode, the value returned is -999. In BTS the returned values represent:</p> <ul style="list-style-type: none"> 0, is QPSK +1, is 8PSK +2, is 16QAM -999, is returned if: <ul style="list-style-type: none"> — 1xEV-DV license is not installed — 1xEV-DV demod enable is set Off — Walsh code length is not 32 — not measuring forward link (Radio Device is MS)

n	Results Returned
<p>n=1 (or not specified) W-CDMA mode</p>	<p>Returns the following 44 comma-separated scalar results:</p> <p>#.Result Name: (type of number) [unit] <explanation></p> <ol style="list-style-type: none"> 1. RMS symbol EVM: (floating) [percent] The despreading (Symbol) RMS EVM for the selected code (OVSF level and number) over the selected measurement period (Meas Interval, Meas Offset, and tDPCH [BTS only]). 2. Peak symbol EVM: (floating) [percent] The despreading (Symbol) peak EVM for the selected code over the selected measurement period (Meas Interval, Meas Offset, and tDPCH [BTS only]). 3. Symbol magnitude error: (floating) [percent] The average magnitude error of Symbol I/Q Polar Vector for the selected code over the selected measurement period (Meas Interval, Meas Offset, and tDPCH [BTS only]). 4. Symbol phase error: (floating) [degree] The average phase error of Symbol I/Q Polar Vector for the selected code over the selected measurement period (Meas Interval, Meas Offset, and tDPCH [BTS only]). 5. Total Power: (floating) [dBm] The total RF power over the selected measurement period (Meas Interval, Meas Offset, and tDPCH [BTS only]). 6. Channel Power: (floating) [dBc or dBm] The absolute or relative (relative to Total Power) power in the entire slot, for the selected code, averaged over the measurement period (Meas Interval, Meas Offset, and tDPCH [BTS only]). 7. tDPCH / tHS-DPCCH: (integer) [x256 chips] <ul style="list-style-type: none"> — BTS mode In tDPCH auto-detection mode, the offset delay time for the selected code (DPCH) from the reference (CPICH slot #0 start point) is returned for valid DPCH. It returns 0 for other channels. In tDPCH manual setting mode, the returned value is the same as “tDPCH” parameter setting. — MS mode There is no tHS-DPCCH auto-detection function. It returns the given “tHS-DPCCH” parameter setting. 8. Total power : (floating) [dBm] Total RF power over one slot specified by Meas Offset. SCH period is included in its calculation. (See item 5. for Total Power over the measurement period selected by Meas Offset and Meas Interval.). 9. Total active power: (floating) [dBc or dBm] The sum of the active code channel powers over one slot specified by Meas Offset. SCH period is included in its calculation.

n	Results Returned
<p>n=1 (or not specified) W-CDMA mode (continued)</p>	<p>10. Common Pilot (CPICH) power: (floating) [dBc or dBm] The average power of the CPICH code (absolute or relative to the Total power including SCH period) over the slot specified by the measOffset including SCH period. In the MS mode, the value returned is -999.</p> <p>11. Maximum active code power: (floating) [dBc or dBm] The maximum average power of the active code channels (absolute or relative to the Total power including SCH period) over the slot specified by the measOffset including SCH period. If no active code is detected the value returned is -999. In the MS mode, the value returned is -999.</p> <p>12. Average active code power: (floating) [dBc or dBm] The average power of all the active code channels (absolute or relative to the Total power) over the slot specified by the measOffset including SCH period. If no active code is detected the value returned is -999. In the MS mode, the value returned is -999.</p> <p>13. Maximum inactive code power: (floating) [dBc or dBm] The maximum average power of the inactive code channels (absolute or relative to the Total power) over the slot specified by the measOffset including SCH period. In the MS mode, the value returned is -999.</p> <p>14. Average inactive code power: (floating) [dBc or dBm] The average power of the inactive code channels (absolute or relative to the Total power) over one slot specified by the Meas Offset SCH period is included in its calculation. In the MS mode, the value returned is -999.</p> <p>15. Number of active channel: (integer) [no unit] The number of active channel for one slot specified by Meas Offset." to Number of active channel</p> <p>16. P-SCH (Primary SCH) Power: (floating) [dBm] The P-SCH power over one slot specified by Meas Offset. In MS mode, the value returned is ñ999.0.</p> <p>17. S-SCH (Secondary SCH) Power: (floating) [dBm] The S-SCH power over one slot specified by Meas Offset. In MS mode, the value returned is ñ999.0.</p> <p>18. DPCCH Power, PRACH Message Control Part Power: (floating) [dBc or dBm] — If Sync Type is DPCCH, dedicated physical control channel (DPCCH) power over one slot specified by Meas Offset. — If Sync Type is PRACH Message, PRACH message control part power over one slot specified by Meas Offset. — In BTS mode, the value returned is ñ999.0</p> <p>19. DPCCH Beta Nominal, PRACH Message Control Part Beta Nominal: (floating) [no unit]. — If Sync Type is DPCCH, the nominal value of DPCCH beta factor over one slot specified by Meas Offset. — Sync Type is PRACH Message, PRACH message control part beta nominal over one slot specified by Meas Offset. — In BTS mode, the value returned is ñ999.0</p>

n	Results Returned
n=1 (or not specified) W-CDMA mode (continued)	<p>20. DPCCH Beta Measured: (floating) [no unit].</p> <ul style="list-style-type: none"> — If Sync Type is DPCCH, the measured value of DPCCH beta factor over one slot specified by Meas Offset. — If Sync Type is PRACH Message, the measured value of PRACH message control part beta factor over one slot specified by Meas Offset. — In BTS mode, the value returned is $\bar{n}999.0$ <p>21. DPDCH 1 Beta Nominal: (floating) [no unit]</p> <ul style="list-style-type: none"> — If Sync Type is DPCCH, the measured value of the DPDCH #1 beta factor over one slot specified by Meas Offset. — If Sync Type is PRACH Message, the measured value of PRACH message data part beta factor over one slot specified by Meas Offset. — If DPCH/E-DPCH is Config 2 w/o DPDCH or Config 3, the value returned is -999.0 — In BTS mode, the value returned is $\bar{n}999.0$ <p>22. DPDCH 1 Beta Measured: (floating) [no unit]</p> <ul style="list-style-type: none"> — If Sync Type is DPCCH, the measured value of DPCCH beta factor over one slot specified by Meas Offset. — If Sync Type is PRACH Message, the measured value of PRACH message control part beta factor over one slot specified by Meas Offset. — If DPCH/E-DPCH is Config 2 w/o DPDCH or Config 3, the value returned is -999.0 <p>23. DPDCH 2 Beta Measured: (floating) [no unit]</p> <ul style="list-style-type: none"> — If Sync Type is DPCCH, the measured value of DPCCH #2 beta factor over one slot specified by Meas Offset. — If DPCH/E-DPCH is not Config 1, the value returned is -999.0 — If Sync Type is PRACH Message, the value returned is -999.0. — In BTS mode, the value returned is -999.0 <p>24. DPDCH 3 Beta Measured: (floating) [no unit]</p> <ul style="list-style-type: none"> — If Sync Type is DPCCH, the measured value of DPCCH #3 beta factor over one slot specified by Meas Offset. — If DPCH/E-DPCH is not Config 1, the value returned is -999.0 — If Sync Type is PRACH Message, the value returned is -999.0. — In BTS mode, the value returned is -999.0 <p>25. DPDCH 4 Beta Measured: (floating) [no unit]</p> <ul style="list-style-type: none"> — If Sync Type is DPCCH, the measured value of DPCCH #4 beta factor over one slot specified by Meas Offset. — If DPCH/E-DPCH is not Config 1, the value returned is -999.0 — If Sync Type is PRACH Message, the value returned is -999.0. — In BTS mode, the value returned is -999.0

n	Results Returned
<p>n=1 (or not specified) W-CDMA mode (continued)</p>	<p>26. DPDCH 5 Beta Measured: (floating) [no unit]</p> <ul style="list-style-type: none"> — If Sync Type is DPCCH, the measured value of DPCCH #5 beta factor over one slot specified by Meas Offset. — If DPCH/E-DPCH is not Config 1, the value returned is -999.0 — If Sync Type is PRACH Message, the value returned is -999.0. — In BTS mode, the value returned is -999.0 <p>27. DPDCH 6 Beta Measured: (floating) [no unit]</p> <ul style="list-style-type: none"> — If Sync Type is DPCCH, the measured value of DPCCH #6 beta factor over one slot specified by Meas Offset. — If DPCH/E-DPCH is not Config 1, the value returned is -999.0 — If Sync Type is PRACH Message, the value returned is -999.0. — In BTS mode, the value returned is -999.0 <p>28. I channel average active power: (floating) [dBc or dBm] The average power of active I channels over one slot specified by Meas Offset. In BTS mode, the value returned is -999.0.</p> <p>29. I channel maximum inactive power: (floating) [dBc or dBm] The maximum average power of inactive I channels over one slot specified by Meas Offset. In the BS mode, the value returned is -999.0.</p> <p>30. Q channel average active power: (floating) [dBc or dBm] The average power of the active Q channels. In BS mode, the value returned is -999.</p> <p>31. Q channel maximum inactive power: (floating) [dBc or dBm] The maximum average power of the inactive Q channels. In the BS mode, the value returned is -999.</p> <p>32. Nominal ratio between HS-DPCCH and DPCCH: (floating)</p> <ul style="list-style-type: none"> — If Sync Type is DPCCH, amplitude ratio of the nominal value based on the measured value of HS-DPCCH beta factor and the DPCCH beta factor. — If Sync Type is PRACH Message, the value returned is -999.0. — In BTS mode, the value returned is -999.0 <p>33. HS-DPCCH Beta Measured: (floating)</p> <ul style="list-style-type: none"> — If Sync Type is DPCCH, the measured value of HS-DPCCH beta factor. — If Sync Type is PRACH Message, the value returned is -999.0. — In BTS mode, the value returned is -999.0

n	Results Returned
<p>n=1 (or not specified) W-CDMA mode (continued)</p>	<p>34. Modulation scheme: an integer number to represent the modulation scheme for the specified channel and measurement time period. 0: QPSK +2: 16QAM Mod Scheme is Auto, the modulation scheme is detected based on the measurement time period specified by Meas Offset, Meas Interval and tDOCH[BTS]/tHS-DPCCH[MS]</p> <ul style="list-style-type: none"> — If Mod Scheme is either QPSK or 16QAM, the given setting is returned. — If Mod Scheme is either QPSK or 16QAM, the given setting is returned <p>This result has meaning only for downlink SF16 (240ksps) channels. (+1 and other values are reserved for different modulation types.)</p> <p>35. First Slot Number: The first slot number of the specified channel by Symbol Rate and Code Number in Capture Interval.</p> <p>36. Channel CDE: (floating) [dBc or dBm] The absolute or relative (relative to Total Power) CDE of the selected code, averaged over the measurement period selected by Meas Offset, Meas Interval and tDPCH [BTS] / tHS-DPCCH[MS].SCH period is included in its calculation [BTS].</p> <p>37. DPCCH Slot Format: (integer)-</p> <ul style="list-style-type: none"> • If Sync Type is DPCCH, the DPCCH slot format value used for synchronization is returned <ul style="list-style-type: none"> — 0: Slot Format 0 — 1: Slot Format 1 — 2: Slot Format 2 — 3: Slot Format 3 — 4: Slot Format 4 — 5: Slot Format 5 • If Sync Type is PRACH, the value returned is -999. • In BTS mode, the value returned is -999. <p>38. Reserved: (integer) The value returned is -999.</p> <p>39. E-DPCCH Beta Nominal: (floating) - If Sync Type is DPCCH and DPCH/E-DPCH Config is one of Config 2 w/ DPCH, Config 2 w/o DPCH and Config 3, the nominal value of E-DPCCH beta factor. (The value is one of 0.333 (=5/15), 0.4 (=6/15), 0.533 (=8/15), ... or 2.0 (=30/15)) - If DPCH/E-DPCH Config is Config 1, the value returned is -999.0. - If Sync Type is PRACH Message, the value returned is -999.0. - In BTS mode, the value returned is -999.0.</p>

n	Results Returned
<p>n=1 (or not specified) W-CDMA mode (continued)</p>	<p>40. E-DPCCH Beta Measured: (floating)</p> <ul style="list-style-type: none"> — If Sync Type is DPCCH and DPCH/E-DPCH Config is one of Config 2 w/ DPCH, Config 2 w/o DPCH and Config 3, the measured value of E-DPCCH beta factor. — If DPCH/E-DPCH Config is Config 1, the value returned is –999.0. If Sync Type is PRACH Message, the value returned is –999.0. — In BTS mode, the value returned is –999.0. <p>41. E-DPDCH 1st on I-axis Beta Measured: (floating)</p> <ul style="list-style-type: none"> — If Sync Type is DPCCH and DPCH/E-DPCH Config is either Config 2 w/o DPCH or Config 3, the measured value of E-DPDCH on I-axis (C8(64), C7(32), C6(16), C5(8), C4(4), C3(2) or C2(1)) beta factor. — If DPCH/E-DPCH Config is either Config 1 or Config 2 w/ DPCH, the value returned is –999.0. — If Sync Type is PRACH Message, the value returned is –999.0. — In BTS mode, the value returned is –999.0. <p>42. E-DPDCH 1st on Q-axis Beta Measured: (floating)</p> <ul style="list-style-type: none"> — If Sync Type is DPCCH and DPCH/E-DPCH Config is either Config 2 w/o DPCH or Config 3, the measured value of E-DPDCH on Q-axis (C8(64), C7(32), C6(16), C5(8), C4(4), C3(2) or C2(1)) beta factor. — If DPCH/E-DPCH Config is either Config 1 or Config 2 w/ DPCH, the value returned is –999.0. — If Sync Type is PRACH Message, the value returned is –999.0. In BTS mode, the value returned is –999.0. <p>43. E-DPDCH 2nd on I-axis Beta Measured: (floating)</p> <ul style="list-style-type: none"> — If Sync Type is DPCCH and DPCH/E-DPCH Config is one of Config 2 w/ DPCH, Config 2 w/o DPCH and Config 3, the measured value of E-DPDCH on I-axis (C8(128), C7(64), C6(32), C5(16), C4(8), C3(4), C2(2) or C1(1)) beta factor. — If DPCH/E-DPCH Config is Config 1, the value returned is –999.0. — If Sync Type is PRACH Message, the value returned is –999.0. — In BTS mode, the value returned is –999.0. <p>44. E-DPDCH 2nd on Q-axis Beta Measured: (floating)</p> <ul style="list-style-type: none"> — If Sync Type is DPCCH and DPCH/E-DPCH Config is one of Config 2 w/ DPCH, Config 2 w/o DPCH and Config 3, the measured value of E-DPDCH on Q-axis (C8(128), C7(64), C6(32), C5(16), C4(8), C3(4), C2(2) or C1(1)) beta factor. — If DPCH/E-DPCH Config is Config 1, the value returned is –999.0. — If Sync Type is PRACH Message, the value returned is –999.0. — In BTS mode, the value returned is –999.0.

n	Results Returned
2 <CDPower>	<p>Code Domain Power:</p> <p>Returns a series of floating point numbers (in either dB or dBm, depending on Meas Type) that represents all the code domain powers.</p> <p>In BTS mode, there are 512 numbers. If the active channel occupies more than the max spreading factor (7.5 ksp) the power is duplicated (active symbol rate / 7.5 ksp) times. (N=512)</p> <p>1st number = 1st code power over one slot specified by Meas Offset including SCH period.</p> <p>2nd number = 2nd code power over one slot specified by Meas Offset including SCH period.</p> <p>...</p> <p>N th number = N th code power over one slot specified by Meas Offset including SCH period.</p> <p>In MS mode, there are 256 I/Q pairs. If the active channel occupies more than the max spreading factor (15 ksp) the power is duplicated (active symbol rate / 15 ksp) times. (N=256)</p> <p>1st number = 1st in-phase code power over one slot specified by Meas Offset</p> <p>2nd number = 1st quad-phase code power over one slot specified by Meas Offset</p> <p>...</p> <p>(2×N - 1) th number = N th in-phase code power over one slot specified by Meas Offset</p> <p>(2×N) th number = N th quad-phase code power over one slot specified by Meas Offset</p>

n	Results Returned
3	<p>Symbol Rate:</p> <p>Returns a series of floating point numbers (in sps) that represents all the code domain symbol rate.</p> <p>In BTS mode, there are 512 numbers. If the active channel occupies more than the max spreading factor (7.5 ksps) the symbol rate is duplicated (active symbol rate / 7.5 ksps) times. (N=512)</p> <p>1st number = 1st code symbol rate over one slot specified by Meas Offset including SCH period</p> <p>2nd number = 2nd code symbol rate over one slot specified by Meas Offset including SCH period</p> <p>...</p> <p>N th number = N th code symbol rate over one slot specified by Meas Offset including SCH period</p> <p>In MS mode, there are 256 I/Q pairs. If the active channel occupies more than the max spreading factor (15 ksps) the symbol rate is duplicated (active symbol rate / 15 ksps) times. (N=256)</p> <p>1st number = 1st in-phase code symbol rate over one slot specified by Meas Offset including SCH period</p> <p>2nd number = 1st quad-phase code symbol rate over one slot specified by Meas Offset including SCH period</p> <p>...</p> <p>(2Y-1) number = N th in-phase code symbol rate over one slot specified by Meas Offset including SCH period</p> <p>(2YN) number = N th quad-phase code symbol rate over one slot specified by Meas Offset including SCH period</p>

n	Results Returned
4	<p>Active Status:</p> <p>Returns series of floating point numbers that show either active or inactive of each code returned in n=2 and 3. When the code is inactive, the result is 0.0, otherwise more than 0.0.</p> <p>In BTS mode, there are 512 numbers. (N=512)</p> <p>1st number = Active or inactive flag of the 1st code 2nd number = Active or inactive flag of the 2nd code. ... N th number = Active or inactive flag of the N th code</p> <p>In MS mode, there are 256 I/Q pairs. (N=256)</p> <p>1st number = 1st In Phase code active flag 2nd number = 1st Quad Phase code active flag ... (2Y N 1) number = N th In Phase code active flag (2Y N) number = N th Quad Phase code active flag</p>
5 <EVM>	<p>Symbol EVM:</p> <p>Returns series of floating point numbers (in percent) that represent EVM of symbols of the selected code channel.</p> <p>The length of the trace depends on the measurement period specified by Meas Offset, Meas Interval and tDPCH[BTS] / tHS-DPCCH[MS].</p>
6 <MERRor>	<p>Symbol Magnitude Error:</p> <p>Returns series of floating point numbers (in percent) that represent magnitude error of symbols of the selected code channel.</p> <p>The length of the trace depends on the measurement period specified by Meas Offset, Meas Interval and tDPCH[BTS] / tHS-DPCCH[MS].</p>
7 <PERRor>	<p>Symbol Phase Error:</p> <p>Returns series of floating point numbers (in degrees) that represent phase error of symbols of the selected code channel.</p> <p>The length of the trace depends on the measurement period specified by Meas Offset, Meas Interval and tDPCH[BTS] / tHS-DPCCH[MS].</p>

n	Results Returned
8	<p>Corrected Measured Trace:</p> <p>Returns series of floating point numbers that alternately represent I and Q pairs of the corrected measured trace of the selected code channel.</p> <p>The magnitude of each I and Q pair is normalized to 1.0.</p> <p>The length of the trace depends on the measurement period specified by Meas Offset, Meas Interval and $tDPCH[BTS] / tHS-DPCCH[MS]$.</p> <p>1st number = I of the 1st symbol decision point 2nd number = Q of the 1st symbol decision point 3rd number = I of the 2nd symbol decision point 4th number = Q of the 2nd symbol decision point ... (2Y-1)th number = I of the Nth symbol decision point (2Y)th number = Q of the Nth symbol decision point</p>
9 <SPOWer>	<p>Symbol Power vs Time:</p> <p>Returns series of floating point numbers (in dBm) that represent the entire trace data of Symbol Power vs. Time of the selected code channel.</p>
10 <CPOWer>	<p>Chip Power vs Time:</p> <p>Returns series of floating point numbers (in dBm) that represent the entire trace data of Chip Power vs. Time</p>

n	Results Returned
11	<p>Demod Bits:</p> <p>Returns series of floating point numbers of symbol values for the selected code channel for the entire capture length.</p> <ul style="list-style-type: none"> - If :CALCulate:CDPower:DBITs[:FORMat] is set to BINary, each value in the trace is either 0.0 or 1.0. - If :CALCulate:CDPower:DBITs[:FORMat] is set to TRIState, each value in the trace is one of 0.0, 1.0 and -1.0 <p>where “-1.0” represents DTX (Discontinuous Transmission) bit or burst-off bit.</p> <p>If a channel’s spreading has been done on only I or Q branch, queried data represents the sequence of corresponding I or Q data.</p> <p>If a channel’s spreading has been done on both I and Q branch and its modulation scheme is QPSK, queried data represents alternating I and Q sequences as follows:</p> <ul style="list-style-type: none"> 1st number = in-phase bit of the 1st I/Q pair 2nd number = quad-phase bit of the 1st I/Q pair 3rd number = in-phase bit of the 2nd I/Q pair 4th number = quad-phase bit of the 2nd I/Q pair (2\sqrt{N} - 1) th number = in-phase bit of the Nth I/Q pair (2\sqrt{N}) th number = quad-phase bit of the Nth I/Q pair <p>where N is the number of the symbols in the entire capture length.</p> <p>If a channel’s modulation scheme is 16QAM, queried data represents alternating i1, q1, i2 and q2 sequences as follows:</p> <ul style="list-style-type: none"> 1st number = i1 bit of the 1st symbol 2nd number = q1 bit of the 1st symbol 3rd number = i2 bit of the 1st symbol 4th number = q2 bit of the 1st symbol 5th number = i1 bit of the 2nd symbol <p>where N is the number of the symbols in the entire capture length.</p>

n	Results Returned
11 (continued)	<p>7th number = i2 bit of the 2nd symbol 8th number = q2 bit of the 2nd symbol (4YN-3) th number = i1 bit of the Nth symbol (4YN-2) th number = q1 bit of the Nth symbol (4YN-1) th number = i2 bit of the Nth symbol (4YN) th number = q2 bit of the Nth symbol</p> <p>where N is the number of the symbols in the entire capture length.</p>
12	<p>Demod Bits For Selected Measurement Period:</p> <p>Returns series of floating point numbers of symbol values for the selected code channel for the measurement period selected by Meas Offset, Meas Interval and tDPCH[BTS] / tHS-DPCCH[MS].</p> <p>- If :CALCulate:CDPower:DBITs[:FORMat] is set to BINary and CALCulate:CDPower:PCKM is set to OFF, each value in the trace is either 0.0 or 1.0. - If :CALCulate:CDPower:DBITs[:FORMat] is set to TRIState and CALCulate:CDPower:PCKM is set to OFF, each value in the trace is one of 0.0, 1.0 and -1.0 where “-1.0” represents DTX (Discontinuous Transmission) bit or burst-off bit.</p> <p>If a channel’s spreading has been done on only I or Q branch, queried data represents the sequence of corresponding I or Q data.</p> <p>If a channel’s spreading has been done on both I and Q branch and its modulation scheme is QPSK, queried data represents alternating I and Q sequences as follows:</p> <p>1st number = in-phase bit of the 1st I/Q pair 2nd number = quad-phase bit of the 1st I/Q pair 3rd number = in-phase bit of the 2nd I/Q pair</p> <p>(continued next page)</p>

n	Results Returned
12 (continued)	<p>4th number = quad-phase bit of the 2nd I/Q pair</p> <p>.....</p> <p>(2Y-1)th number = in-phase bit of the Nth I/Q pair</p> <p>(2Y)th number = quad-phase bit of the Nth I/Q pair</p> <p>where N is the number of the symbols in the measurement period selected by Meas Offset, Meas Interval and tDPCH[BTS] / tHS-DPCCH[MS].</p> <p>If a channel's modulation scheme is 16QAM, queried data represents alternating i1, q1, i2 and q2 sequences as follows:</p> <p>1st number = i1 bit of the 1st symbol</p> <p>2nd number = q1 bit of the 1st symbol</p> <p>3rd number = i2 bit of the 1st symbol</p> <p>4th number = q2 bit of the 1st symbol</p> <p>5th number = i1 bit of the 2nd symbol</p> <p>6th number = q1 bit of the 2nd symbol</p> <p>7th number = i2 bit of the 2nd symbol</p> <p>8th number = q2 bit of the 2nd symbol</p> <p>.....</p> <p>(4Y-3) th number = i1 bit of the Nth symbol</p> <p>(4Y-2) th number = q1 bit of the Nth symbol</p> <p>(4Y-1) th number = i2 bit of the Nth symbol</p> <p>(4Y) th number = q2 bit of the Nth symbol</p> <p>where N is the number of the symbols in the measurement period selected by Meas Offset, Meas Interval and tDPCH[BTS] / tHS-DPCCH[MS].</p> <p>If CALCulate:CDPower:PCKM is set to PKM1(=Mode1), demod bits per symbol are packed into one float value in bit-slice manner as the followings.</p> <p>(continued next page)</p>

n	Results Returned
12 (continued)	<p>- For 16QAM channels: 16QAM (No DTX):Float value 00.....0X3X2X1X0 where X3:I1 X2:Q1 X1:I2 X0:Q2</p> <p>- For QPSK channels: QPSK (With DTX): Float value 00.....0M1M0B1B0 where M1:Mask for B1 (1:DTX, 0:Normal) M0:Mask for B0 (1:DTX, 0:Normal) B1:I B0:Q</p> <p>And, the returned data is a sequence of float number as follows: 1st number = Packed Demod bits of 1st symbol 2nd number = Packed Demod bits of 2nd symbol 3rd number = Packed Demod bits of 3rd symbol ... Nth number = Packed Demod bits of Nth symbol</p> <p>where N is the number of the symbols in the measurement period selected by Meas Offset, Meas Interval and tDPCH[BTS] / tHS-DPCCH[MS].</p> <p>Demod Bits supports AMC(Adaptive Modulation and Coding) for HSDPA channels. Therefore, in Demod Bits, QPSK and 16QAM bits could be mixed. To identify whether the Demod bits of each symbol is of either QPSK or 16QAM, query the Modulation Scheme returned by 14th trace (Modulation Scheme). About how to refer between Modulation Scheme and Demod bits in detail, see .</p>

n	Results Returned
<p>13 <CDError></p>	<p>Code Domain Error:</p> <p>Returns a series of floating point numbers (in dB or dBm) that represents all the code domain errors.</p> <p>In BTS mode, there are 512 numbers. If the active channel occupies more than the max spreading factor (7.5 kbps) the error is duplicated (active symbol rate / 7.5 kbps) times. (N=512)</p> <p>1st number = 1st code domain error over one slot specified by Meas Offset including SCH period.</p> <p>2nd number = 2nd code domain error over one slot specified by Meas Offset including SCH period.</p> <p>...</p> <p>N th number = N th code domain error over one slot specified by Meas Offset including SCH period.</p> <p>In MS mode, there are 256 I/Q pairs. If the active channel occupies more than the max spreading factor (15 kbps) the power is duplicated (active symbol rate / 15 kbps) times. (N=256)</p> <p>1st number = 1st in-phase code domain error over one slot specified by Meas Offset including SCH period.</p> <p>2nd number = 1st quad-phase code domain error over one slot specified by Meas Offset including SCH period.</p> <p>...</p> <p>(2YN - 1) number = N th in-phase code domain error over one slot specified by Meas Offset including SCH period.</p> <p>(2YN) number = N th quad-phase code domain error over one slot specified by Meas Offset including SCH period.</p>

n	Results Returned
14 <Modulation Scheme>	<p>Modulation Scheme:</p> <p>Returns a series of floating point numbers that represents the modulation scheme slot-by-slot for measurement period selected by Meas Offset, Meas Interval and tDPCH[BTS] / tHS-DPCCH[MS].</p> <p>The meaning of the number is :</p> <p>0.0 = QPSK (Quadrature Phase Shift Keying)</p> <p>2.0 = 16QAM (16Quadrature Amplified Modulation)</p> <p>1st number = Modulation Scheme of the slot specified by Meas Offset</p> <p>2nd number = Modulation Scheme of the slot specified by Meas Offset + 1</p> <p>3rd number = Modulation Scheme of the slot specified by Meas Offset +2</p> <p>...</p> <p>Nth number = Modulation Scheme of the slot specified by Meas Offset + N where N is Meas Interval.</p>

n	Results Returned
n=1 (or not specified) 1xEV-DO mode	<p>Returns the following comma-delimited scalar results, in the following order:</p> <ol style="list-style-type: none"> 1. Total power is a floating point number (in dBm) of the total RF power over the measurement interval. NOTE: The following power results are computed by the CDP measurement. The unit used in the computation, either dB or dBm, is determined by the setting of the <code>CALCulate:CDPower:TYPE</code> command. When the selection is <code>ABSolute</code>, the unit used is dBm. When the selection is <code>RELative</code>, the unit used is dB relative to Total Power (above). 2. Total active power is a floating point number (in dB or dBm depending on the measurement type) of the sum of the active powers (–999.0 when no active channel is detected). 3. Maximum active power is a floating point number (in dB or dBm depending on the measurement type) of the maximum average power of the active code (–999.0 when no active channel is detected in I/Q Combined=On mode. Always –999.0 in I/Q Combined=Off mode) 4. Average active power is a floating point number (in dB or dBm depending on the measurement type) of the average power of all the active traffic channels (–999.0 when no active channel is detected in I/Q Combined=On mode. Always –999.0 in I/Q Combined=Off mode). 5. Maximum inactive power is a floating point number (in dB or dBm depending on the measurement type) of the maximum average power of the inactive traffic channels. (–999.0 in I/Q Combined=Off mode) 6. Average inactive power is a floating point number (in dB or dBm depending on the measurement type) of the average power of the inactive traffic channels. (–999.0 in I/Q Combined=Off mode) 7. Number of active channels 8. I channel average active power is a floating point number (in dB or dBm depending on the measurement type) of the average power of the active I channels. (–999.0 when I/Q Combined=On mode or when no active channel is detected in I/Q Combined=Off mode). 9. I channel maximum inactive power is a floating point number (in dB or dBm depending on the measurement type) of the maximum average power of the inactive I channels. (–999.0 when I/Q Combined=On mode) 10. Q channel average active power is a floating point number (in dB or dBm depending on the measurement type) of the average power of the active Q channels. (–999.0 when I/Q Combined=On mode or when no active channel is detected in I/Q Combined=Off mode). 11. Q channel maximum inactive power is a floating point number (in dB or dBm depending on the measurement type) of the maximum average power of the inactive Q channels. (–999.0 when I/Q Combined=On mode)

n	Results Returned
n=1 (or not specified) 1xEV-DO mode (continued)	<p>12. Preamble Length is a floating point number (in chips).</p> <p>13. Preamble MAC Index is an integer number of MAC index.</p> <p>14. Minimum Active Power is a floating point number (in dB or dBm depending on the measurement type) of the minimum average power of the active code (–999.0 when no active channel is detected in I/Q Combined=On mode. Always –999.0 in I/Q Combined=Off mode)</p> <p>15. I channel maximum inactive power is a floating point number (in dB or dBm depending on the measurement type) of the maximum average power of the inactive I channels. (–999.0 when I/Q Combined=On mode)</p> <p>16. I channel minimum inactive power is a floating point number (in dB or dBm depending on the measurement type) of the minimum average power of the inactive I channels. (–999.0 when I/Q Combined=On mode)</p> <p>17. Q channel maximum inactive power is a floating point number (in dB or dBm depending on the measurement type) of the maximum average power of the inactive Q channels. (–999.0 when I/Q Combined=On mode)</p> <p>18. Q channel minimum inactive power is a floating point number (in dB or dBm depending on the measurement type) of the minimum average power of the inactive Q channels. (–999.0 when I/Q Combined=On mode)</p>
2 cdmaOne mode	<p>Returns floating point numbers that are the trace data of the code domain <i>power</i> trace for all 64 Walsh codes. This series of 64 numbers represent the relative power levels (in dB) of all 64 walsh codes, with respect to the carrier power.</p>

n	Results Returned
2 cdma2000 mode	<p>Returns a series of floating point numbers (in dB or dBm depending on the measurement type) that represents all the code domain powers.</p> <p>With a device of BTS, there are 64 or 128 numbers depending on CALCulate:CDPower:WCODe:BASE. If the active channel occupies more than the max spreading factor (64 or 128 Walsh Code length depending on CALCulate:CDPower:WCODe:BASE) the power is duplicated (CALCulate:CDPower:WCODe:BASE / active Walsh code length) times.</p> <p>1st number = 1st code power over the slot 2nd number = 2nd code power over the slot ... Nth number = Nth code power over the slot</p> <p>With a device of MS, there are 256 I/Q pairs. If the active channel occupies more than the max spreading factor (C8) the power is duplicated (active Cx / C8) times.</p> <p>1st number = 1st in-phase code power over the slot 2nd number = 1st quad-phase code power over the slot ... (2×N-1)th number = Nth in-phase code power over the slot (2×N)th number = Nth quad-phase code power over a slot</p> <p>N = the number of codes detected. The total number of codes varies because of the different symbol rates of each code.</p>
2 1xEV-DO mode	<p>Returns a series of floating point numbers (in dB or dBm depending on the measurement type) that represents all the code domain powers.</p> <p>When I/Q Combined=On, total is 16 for Data, 32 for Pilot, and 64 for MAC. If the active channel occupies more than the max spreading factor (16 for Data, 32 for Pilot, and 64 for MAC) the power is duplicated.</p> <p>1st number = 1st code power over the slot 2nd number = 2nd code power over the slot ... Nth number = Nth code power over the slot</p> <p>When I/Q Combined=Off, results are returned alternatively. Total is 16 I/Q pairs for Data, 32 for Pilot, and 64 for MAC. If the active channel occupies more than the max spreading factor (16 for Data, 32 for Pilot, and 64 for MAC) the power is duplicated.</p> <p>1st number = 1st in-phase code power over the slot 2nd number = 1st quad-phase code power over the slot ... (2×N-1)th number = Nth in-phase code power over the slot (2×N)th number = Nth quad-phase code power over a slot</p> <p>N = the number of codes detected. The total number of codes varies because of the different symbol rates of each code.</p>

n	Results Returned
<p>2 W-CDMA.mode</p>	<p>Returns a series of floating point numbers (in either dB or dBm, depending on Meas Type) that represents all the code domain powers.</p> <p>With a device of BTS, there are 512 numbers. If the active channel occupies more than the max spreading factor (7.5 ksps) the power is duplicated (active symbol rate/7.5 ksps) times. (N=512)</p> <p>1st number = 1st code power over the measurement period (1 slot specified by Meas Offset) including SCH period.</p> <p>2nd number = 2nd code power over the measurement period (1 slot specified by Meas Offset) including SCH period.</p> <p>...</p> <p>N th number = N th code power over the measurement period (1 slot specified by Meas Offset) including SCH period.</p> <p>With a device of MS, there are 256 I/Q pairs. If the active channel occupies more than the max spreading factor (15 ksps) the power is duplicated (active symbol rate / 15 ksps) times. (N=256)</p> <p>1st number = 1st in-phase code power over the measurement period (1 slot specified by Meas Offset)</p> <p>2nd number = 1st quad-phase code power over the measurement period (1 slot specified by Meas Offset)</p> <p>...</p> <p>(2YN-1) number = N th in-phase code power over the measurement period (1 slot specified by Meas Offset)</p> <p>(2YN) number = N th quad-phase code power over the measurement period (1 slot specified by Meas Offset)</p>
<p>3 cdmaOne mode</p>	<p>Returns floating point numbers that are the trace data of the code domain <i>timing</i> trace for all 64 Walsh codes. This series of 64 numbers represent the relative timing estimations (in seconds) of the codes, relative to the pilot channel. Typical values are on the order of 1 ns.</p>

n	Results Returned
<p>3 cdma2000 mode</p>	<p>Returns a series of floating point numbers (in symbol rate) that represent all code domain symbol rates.</p> <p>With a device of BTS, there are 64 or 128 numbers depending on CALCulate:CDPower:WCODe:BASE. If the active channel occupies more than the max spreading factor (64 or 128 Walsh code length depending on CALCulate:CDPower:WCODe:BASE) the power is duplicated (CALCulate:CDPower:WCODe:BASE / active Walsh code length) times.</p> <p>1st number = 1st code symbol rate over the slot 2nd number = 2nd code symbol rate over the slot ... Nth number = Nth code symbol rate over the slot</p> <p>With a device of MS, there are 256 I/Q pairs. If the active channel occupies more than the max spreading factor (C8) the power is duplicated (active Cx / C8) times.</p> <p>1st number = 1st in-phase code symbol rate over the slot 2nd number = 1st quad-phase code symbol rate over the slot ... (2×N-1)th number = Nth in-phase code symbol rate over the slot (2×N)th number = Nth quad-phase code symbol rate over the slot</p> <p>N = the number of codes detected. The total number of codes varies because of the different symbol rates of each code.</p>
<p>3 1xEV-DO mode</p>	<p>Returns a series of floating point numbers (in dB or dBm depending on the measurement type) that represents all the code domain symbol rates.</p> <p>When I/Q Combined=On, total is 16 for Data, 32 for Pilot, and 64 for MAC. If the active channel occupies more than the max spreading factor (16 for Data, 32 for Pilot, and 64 for MAC) the power is duplicated.</p> <p>1st number = 1st code symbol rate over the slot 2nd number = 2nd code symbol rate over the slot ... Nth number = Nth code symbol rate over the slot</p> <p>When I/Q Combined=Off, results are returned alternatively. Total is 16 I/Q pairs for Data, 32 for Pilot, and 64 for MAC. If the active channel occupies more than the max spreading factor (16 for Data, 32 for Pilot, and 64 for MAC) the power is duplicated.</p> <p>1st number = 1st in-phase code symbol rate over the slot 2nd number = 1st quad-phase code symbol rate over the slot ... (2×N-1)th number = Nth in-phase code symbol rate over the slot (2×N)th number = Nth quad-phase code symbol rate over a slot</p> <p>N = the number of codes detected. The total number of codes varies because of the different symbol rates of each code.</p>

n	Results Returned
3 W-CDMA mode	<p>Returns a series of floating point numbers (in symbol rate) that represents all the code domain symbol rate.</p> <p>With a device of BTS, there are 512 numbers. If the active channel occupies more than the max spreading factor (7.5 ksp) the symbol rate is duplicated (active symbol rate/7.5 ksp) times. (N=512)</p> <p>1st number = 1st code symbol rate over the measurement period (1 slot specified by Meas Offset) including SCH period</p> <p>2nd number = 2nd code symbol rate over the measurement period (1 slot specified by Meas Offset) including SCH period</p> <p>...</p> <p>N th number = N th code symbol rate over the measurement period (1 slot specified by Meas Offset) including SCH period</p> <p>With a device of MS, there are 256 I/Q pairs. If the active channel occupies more than the max spreading factor (15 ksp) the symbol rate is duplicated (active symbol rate / 15 ksp) times. (N=256)</p> <p>1st number = 1st in-phase code symbol rate over the measurement period (1 slot specified by Meas Offset)</p> <p>2nd number = 1st quad-phase code symbol rate over the measurement period (1 slot specified by Meas Offset)</p> <p>...</p> <p>(2Y-1) number = N th in-phase code symbol rate over the measurement period (1 slot specified by Meas Offset)</p> <p>(2YN) number = N th quad-phase code symbol rate over the measurement period (1 slot specified by Meas Offset)</p>
4 cdmaOne mode	<p>Returns floating point numbers that are the trace data of the code domain <i>phase</i> trace for all 64 Walsh codes. This series of 64 numbers represent the relative phase estimations (in radians) of the codes, relative to the pilot channel. Typical values are on the order of 1 mrad.</p>
4 cdma2000 mode	<p>Returns a series of floating point numbers that show either active or inactive status for each of the code powers returned in n=2. (See above.) If a code is inactive, the value returned is 0.0, otherwise a value >0.0 is returned.</p> <p>1st number = active or inactive flag of the 1st code</p> <p>...</p> <p>Nth number = active or inactive flag of the Nth code</p> <p>(where N= the number of codes identified)</p>

n	Results Returned
<p>4 W-CDMA mode</p>	<p>Returns series of floating point numbers that show either active or inactive of each code returned in n=2 and 3. When the code is inactive, the result is 0.0, otherwise more than 0.0.</p> <p>With a device of BTS, there are 512 numbers. (N=512)</p> <p>1st number = Active or inactive flag of the 1st code 2nd number = Active or inactive flag of the 2nd code. ... N th number = Active or inactive flag of the N th code</p> <p>With a device of MS, there are 256 I/Q pairs. (N=256)</p> <p>1st number = 1st In Phase code active flag 2nd number = 1st Quad Phase code active flag ... (2Y-1) number = N th In Phase code active flag (2Y) number = N th Quad Phase code active flag</p>
<p>4 1xEV-DO mode</p>	<p>Returns a series of floating point numbers that show either active or inactive status for each of the code powers returned in n=2 and 3. If a code is inactive, the value returned is 0.0, otherwise a value >0.0 is returned.</p> <p>When I/Q Combined=On, I/Q combined results are returned. 1st number = active or inactive flag of the 1st code ... Nth number = active or inactive flag of the Nth code</p> <p>When channel type=Pilot or MAC, results are returned alternatively. 1st number = 1st in-phase code active flag 2nd number = 1st Quad Phase code active flag ... (2×N-1)th number = Nth in-phase code active flag (2×N)th number = Nth Quad Phase code active flag</p> <p>N = the number of codes detected. The total number of codes varies because of the different symbol rates of each code. 2nd number = 1st quad-phase code symbol rate over the slot</p>
<p>5 cdma2000 mode</p>	<p>Returns a series of floating point numbers (in percent) that represent each sample in the <i>EVM</i> trace. The first number is the symbol 0 decision point and there are X points per symbol. Therefore, the decision points are at 0, 1×X, 2×X, 3×X. . .</p> <p>(where X = the number of points per chip)</p>

n	Results Returned
5 W-CDMA mode <EVM>	Returns a series of floating point numbers (in percent) that represent each sample in the EVM trace. The first number is the symbol 0 decision point and there are X points per symbol. Therefore, the decision points are at 0, 1xX, 2xX, 3xX... (X = the number of points per chip)
5 1xEV-DO mode	Returns series of floating point numbers that alternately represent I and Q pairs of the <i>corrected measured</i> trace. The magnitude of each I and Q pair is normalized to 1.0. The first number is the in-phase (I) sample of symbol 0 decision point and the second is the quadrature-phase (Q) sample of symbol 0 decision point. As in the EVM, there are X points per symbol, so that: 1st number is I of the symbol 0 decision point 2nd number is Q of the symbol 0 decision point ... (2xX)+1 number is I of the symbol 1 decision point (2xX)+2 number is Q of the symbol 1 decision point ... (2xX)xN+1th number is I of the symbol N decision point (2xX)xN+2th number is Q of the symbol N decision point where X = the number of points per symbol, and N = the number of symbols
6 cdma2000 mode	Returns a series of floating point numbers (in percent) that represent each sample in the <i>magnitude error</i> trace. The first number is the symbol 0 decision point and there are X points per symbol. Therefore, the decision points are at 0, 1xX, 2xX, 3xX... (where X = the number of points per chip)
6 W-CDMA <MERRor>	Returns series of floating point numbers (in percent) that represent each sample in the magnitude error trace. The first number is the symbol 0 decision point and there are X points per symbol. Therefore, the decision points are at 0, 1xX, 2xX, 3xX ... (X = the number of points per chip)
6 1xEV-DO mode	Returns series of floating point numbers (in dBm) that represent the trace data of the chip power vs. time.
7 cdma2000 mode	Returns a series of floating point numbers (in degrees) that represent each sample in the <i>phase error</i> trace. The first number is the symbol 0 decision point and there are X points per symbol. Therefore, the decision points are at 0, 1xX, 2xX, 3xX... (where X = the number of points per chip)
7 W-CDMA <PERRor>	Returns series of floating point numbers (in degree) that represent each sample in the phase error trace. The first number is the symbol 0 decision point and there are X points per symbol. Therefore, the decision points are at 0, 1xX, 2xX, 3xX ... (X = the number of points per chip)

n	Results Returned
8 cdma2000 mode	<p>Returns series of floating point numbers that alternately represent I and Q pairs of the <i>corrected measured</i> trace. The magnitude of each I and Q pair is normalized to 1.0. The first number is the in-phase (I) sample of symbol 0 decision point and the second is the quadrature-phase (Q) sample of symbol 0 decision point. As in the EVM, there are X points per symbol, so that:</p> <p>1st number is I of the symbol 0 decision point 2nd number is Q of the symbol 0 decision point ... (2×X)+1 number is I of the symbol 1 decision point (2×X)+2 number is Q of the symbol 1 decision point ... (2×X)×N+1th number is I of the symbol N decision point (2×X)×N+2th number is Q of the symbol N decision point</p> <p>where X = the number of points per symbol, and N = the number of symbols</p> <p>NOTE: "Normalization" is done so that ideal reference decision points for I and Q pairs of the corrected measured trace are scaled as follows:</p> <ul style="list-style-type: none"> — QPSK: I and Q = +/-1.0/SQRT(2) Radius [distance from origin] = 1.0 — 8PSK: I and Q = +/-0.9239 (or=COS(pi/8)), +/-0.3827 Radius [distance from origin] = 1.0 — 16QAM: I and Q = +/-0.3162 (or=SQRT(0.1)), +/-0.9487 (or=SQRT(0.9)) Radius = 0.4472 (or=SQRT(0.2)), 1.0, 1.3416 (or=SQRT(1.8))
8 W-CDMA mode	<p>Returns series of floating point numbers that alternately represent I and Q pairs of the corrected measured trace. The magnitude of each I and Q pair are normalized to 1.0. The first number is the in-phase (I) sample of symbol 0 decision point and the second is the quadrature-phase (Q) sample of symbol 0 decision point. As in the EVM, there are X points per symbol, so that:</p> <p>1st number = I of the symbol 0 decision point 2nd number = Q of the symbol 0 decision point ... (2xX)+1st number = I of the symbol 1 decision point (2xX)+2nd number = Q of the symbol 1 decision point ... (2xX)xN th + 1 number = I of the symbol N decision point (2xX)xN th + 2 number = Q of the symbol N decision point (X = the number of points per chip)</p>

n	Results Returned
9 cdma2000, or W-CDMA mode <SPOWer>	Returns series of floating point numbers (in dBm) that represent the entire trace data of the symbol power vs. time.
10 cdma2000, or W-CDMA mode <CPOWer>	Returns series of floating point numbers (in dBm) that represent the entire trace data of the chip power vs. time.

n	Results Returned
11 cdma2000	<p>Returns a series of floating point numbers (0.0 or 1.0) of the symbol values (demodulated bits) for the selected spread code. The results are returned as alternating values of I,Q,I,Q . . . for the entire measurement interval.</p> <p>When using 1xEV-DV with 8PSK or 16QAM, it returns a series of floating point numbers (0.0 or 1.0) of the symbol values for the selected code with the entire capture length.</p> <p>For 8PSK modulation the queried data represents alternating s0, s1 and s2 sequence as follows:</p> <p>1st number = s0 bit of the 1st symbol 2nd number = s1 bit of the 1st symbol 3rd number = s2 bit of the 1st symbol 4th number = s0 bit of the 2nd symbol 5th number = s1 bit of the 2nd symbol 6th number = s2 bit of the 2nd symbol . . . (3×N-2) number = s0 bit of the Nth symbol (3×N-1) number = s1 bit of the Nth symbol (3×N) number = s2 bit of the Nth symbol where N is the number of the symbols in the capture length.</p> <p>For 16QAM modulation the queried data represents alternating s0, s1, s2 and s3 sequence as follows:</p> <p>1st number = s0 bit of the 1st symbol 2nd number = s1 bit of the 1st symbol 3rd number = s2 bit of the 1st symbol 4th number = s3 bit of the 1st symbol 5th number = s0 bit of the 2nd symbol 6th number = s1 bit of the 2nd symbol 7th number = s2 bit of the 2nd symbol 8th number = s3 bit of the 2nd symbol . . . (4×N-3) number = s0 bit of the Nth symbol (4×N-2) number = s1 bit of the Nth symbol (4×N-1) number = s2 bit of the Nth symbol (4×N) number = s3 bit of the Nth symbol where N is the number of the symbols in the capture length.</p>

n	Results Returned
<p>11 W-CDMA mode</p>	<p>Returns series of floating point numbers (0.0 or 1.0) of symbol values for the selected code with the entire capture length, when :CALCulate:CDPower:DBITs[:FORMat] is set to BINary.</p> <p>Returns series of floating point numbers (0.0, 1.0 or -1.0) of symbol values for the selected code with the entire capture length, when :CALCulate:CDPower:DBITs[:FORMat] is set to TRIState. “-1.0” represents DTX (Discontinuous Transmission) bit.</p> <p>If a channel’s spreading has been done on only I or Q branch, queried data represents the sequence of I or Q or both of I and Q data.</p> <p>If a channel’s spreading has been done on both I and Q branch and its modulation scheme is QPSK, queried data represents alternating I and Q sequences as follows:</p> <p>1st number = in-phase bit of the 1st I/Q pair 2nd number = quad-phase bit of the 1st I/Q pair 3rd number = in-phase bit of the 2nd I/Q pair 4th number = quad-phase bit of the 2nd I/Q pair (2×N-1)th number = in-phase bit of the Nth I/Q pair (2∕N)th number = quad-phase bit of the Nth I/Q pair where N is the number of the symbols in the entire capture length.</p> <p>If a channel’s modulation scheme is 16QAM, queried data represents alternating i1, q1, i2 and q2 sequences as follows:</p> <p>1st number = i1 bit of the 1st symbol 2nd number = q1 bit of the 1st symbol 3rd number = i2 bit of the 1st symbol 4th number = q2 bit of the 1st symbol 5th number = i1 bit of the 2nd symbol 6th number = q1 bit of the 2nd symbol 7th number = i2 bit of the 2nd symbol 8th number = q2 bit of the 2nd symbol (4∕N-3)th number = i1 bit of the Nth symbol (4∕N-2)th number = q1 bit of the Nth symbol (4∕N-1)th number = i2 bit of the Nth symbol (4∕N)th number = q2 bit of the Nth symbol where N is the number of the symbols in the entire capture length.</p>

n	Results Returned
<p>12 W-CDMA mode</p>	<p>Returns series of floating point numbers (0.0 or 1.0) of symbol values for the selected code with the period selected by Meas Interval, and Meas Offset and tDPCH, when :CALCulate:CDPower:DBITs[:FORMat] is set to BINary, and CALCulate:CDPower:PCKM is set to OFF.</p> <p>Returns series of floating point numbers (0.0, 1.0 or -1.0) of symbol values for the selected code with the period selected by Meas Interval, and Meas Offset and tDPCH, when :CALCulate:CDPower:DBITs[:FORMat] is set to TRIState, and CALCulate:CDPower:PCKM is set to OFF, “-1.0” represents DTX (Discontinuous Transmission) bit.</p> <p>The additional description is almost same as that for 11 except for the definition of N.</p> <p>If a channel’s spreading has been done on only I or Q branch, queried data represents the sequence of I or Q or both I and Q data.</p> <p>If a channel’s spreading has been done on both I and Q branch and its modulation scheme is QPSK, queried data represents alternating I and Q sequences as follows:</p> <p>1st number = in-phase bit of the 1st I/Q pair 2nd number = quad-phase bit of the 1st I/Q pair 3rd number = in-phase bit of the 2nd I/Q pair 4th number = quad-phase bit of the 2nd I/Q pair (2Y-1)th number = in-phase bit of the Nth I/Q pair (2YN)th number = quad-phase bit of the Nth I/Q pair</p> <p>where N is the number of the symbols in the selected time by Meas Interval and Meas Offset.</p> <p>If a channel’s modulation scheme is 16QAM, queried data represents alternating i1, q1, i2 and q2 sequences as follows:</p> <p>1st number = i1 bit of the 1st symbol 2nd number = q1 bit of the 1st symbol 3rd number = i2 bit of the 1st symbol 4th number = q2 bit of the 1st symbol 5th number = i1 bit of the 2nd symbol 6th number = q1 bit of the 2nd symbol</p> <p>Returns series of floating point numbers of symbol values for the selected code with the period selected by Meas Interval, and Meas Offset and tDPCH when CALCulate:CDPower:PCKM is set to PKM1(=Mode1).</p> <p>(continued next page)</p>

n	Results Returned
12 W-CDMA (continued)	<p>Demod Bits per symbol is packed into 1 float value in bit-slice manner as following.</p> <p>16QAM(No DTX):Float value 0.....0X3X2X1X0 (X3:I1, X2:Q1, X1:I2, X0:Q2)</p> <p>QPSK(With DTX): Float value 0.....0M1M0B1B0</p> <p>The meaning of each bit is :</p> <p>M1:Mask for B1 (1:DTX, 0:Normal), M0:Mask for B0, and B1:I, B0:Q)</p> <p>N = Meas Interval</p> <p>1st number = Packed Demod bits of 1st symbol 2nd number = Packed Demod bits of 2nd symbol 3rd number = Packed Demod bits of 3rd symbol ... Nth number = Packed Demod bits of Nth symbol</p>

n	Results Returned
<p>13</p> <p>W-CDMA</p> <p><CDError></p>	<p>Returns a series of floating point numbers (in dB or dBm) that represents all the code domain errors.</p> <p>With a device of BTS, there are 512 numbers. If the active channel occupies more than the max spreading factor (7.5 ksp/s) the error is duplicated (active symbol rate/7.5 ksp/s) times. (N=512)</p> <p>1st number = 1st code domain error over the measurement period (1 slot specified by Meas Offset)</p> <p>2nd number = 2nd code domain error over the measurement period (1 slot specified by Meas Offset)</p> <p>...</p> <p>N th number = N th code domain error over the measurement period (1 slot specified by Meas Offset)</p> <p>With a device of MS, there are 256 I/Q pairs. If the active channel occupies more than the max spreading factor (15 ksp/s) the power is duplicated (active symbol rate / 15 ksp/s) times. (N=256)</p> <p>1st number = 1st in-phase code domain error over the measurement period (1 slot specified by Meas Offset)</p> <p>2nd number = 1st quad-phase code domain error over the measurement period (1 slot specified by Meas Offset)</p> <p>...</p> <p>(2\timesN-1) number = N th in-phase code domain error over the measurement period (1 slot specified by Meas Offset)</p> <p>(2\timesN) number = N th quad-phase code domain error over the measurement period (1 slot specified by Meas Offset)</p>
<p>14 W-CDMA mode (Modulation Scheme)</p>	<p>Returns a series of floating point numbers that represents the modulation scheme slot-by-slot.</p> <p>The meaning of the number is :</p> <p>0.0 = QPSK (Quadrature Phase Shift Keying)</p> <p>2.0 = 16QAM (16Quadrature Amplified Modulation)</p> <p>N = Meas Interval</p> <p>1st number = Modulation Scheme of the slot specified by Meas Offset</p> <p>2nd number = Modulation Scheme of the slot specified by Meas Offset + 1</p> <p>3rd number = Modulation Scheme of the slot specified by Meas Offset +2</p> <p>...</p> <p>Nth number = Modulation Scheme of the slot specified by Meas Offset + N</p>

Channel Power Measurement

For E4406A this measures the total rms power in a specified integration bandwidth. You must be in the Basic, cdmaOne, cdma2000, W-CDMA, or 1xEV-DO mode to use these commands. Use INSTRument:SElect to set the mode.

For PSA this measures the total rms power in a specified integration bandwidth. You must be in the cdmaOne, cdma2000, or W-CDMA, or 1xEV-DO mode to use these commands. Use INSTRument:SElect to set the mode.

The general functionality of CONFigure, FETCh, MEASure, and READ are described at the beginning of this section. See the SENSE:CHPower commands for more measurement related commands.

```
:CONFigure:CHPower
:INITiate:CHPower
:FETCh:CHPower [n] ?
:READ:CHPower [n] ?
:MEASure:CHPower [n] ?
```

History: For E4406A:
 Added to Basic mode, version A.03.00 or later

Key Path: **Measure, Channel Power**
 After the measurement is selected, press **Restore Meas Defaults** to restore factory defaults.

Measurement Results Available

n	Results Returned
0	Returns unprocessed I/Q trace data, as a series of trace point values, in volts. The I values are listed first in each pair, using the 0 through even-indexed values. The Q values are the odd-indexed values.
n=1 (or not specified)	Returns scalar results: <ol style="list-style-type: none"> Channel Power is a floating point number representing the total channel power in the specified integration bandwidth. PSD (Power Spectral Density) is the power (in dBm/Hz) in the specified integration bandwidth.
2	Returns floating point numbers that are the captured trace data of the power (in dBm/resolution BW) of the signal. The frequency span of the captured trace data is specified by the Span key.

QPSK Error Vector Magnitude Measurement

This measures the QPSK error vector magnitude of each symbol. You must be in the cdma2000, W-CDMA, or 1xEV-DO mode to use these commands. Use INSTRument:SElect to set the mode.

The general functionality of CONFigure, FETCh, MEASure, and READ are described at the beginning of this section. See the SENSE:EVMQpsk commands for more measurement related commands.

:CONFigure:EVMQpsk

:INITiate:EVMQpsk

:FETCh:EVMQpsk [n] ?

:READ:EVMQpsk [n] ?

:MEASure:EVMQpsk [n] ?

History: Version A.03.00 or later

Key Path: **Measure, QPSK EVM**

After the measurement is selected, press **Restore Meas Defaults** to restore factory defaults.

Measurement Results Available

n	Results Returned
0	Returns unprocessed I/Q trace data, as a data array of trace point values, in volts.

n	Results Returned
1 (default)	<p>Returns scalar results, in the following order.</p> <ol style="list-style-type: none"> 1. RMS EVM is a floating point number (in percent) of EVM over the entire measurement area. 2. RMS EVM maximum is the maximum RMS EVM over the averaged counts 3. Peak EVM is a floating point number (in percent) of peak EVM in the measurement area. 4. Peak EVM maximum is the maximum peak EVM over the averaged counts. 5. Magnitude error is a floating point number (in percent) of average magnitude error over the entire measurement area. 6. Magnitude error maximum is the maximum magnitude error over the averaged counts. 7. Phase error is a floating point number (in degree) of average phase error over the entire measurement area. 8. Phase error maximum is the maximum phase error over the averaged counts. 9. Frequency error is a floating point number (in Hz) of the frequency error in the measured signal. 10. Frequency error maximum is the maximum frequency error over the averaged counts. 11. I/Q origin offset is a floating point number (in dB) of the I and Q error (magnitude squared) offset from the origin.
2	<p>EVM trace – returns series of floating point numbers (in percent) that represent each sample in the EVM trace. The first number is the symbol 0 decision point. There are X points per symbol ($X = \text{points/chip}$). Therefore, the decision points are at $0, 1 \times X, 2 \times X, 3 \times X \dots$</p>
3	<p>Magnitude error trace – returns series of floating point numbers (in percent) that represent each sample in the magnitude error trace. The first number is the symbol 0 decision point. There are X points per symbol ($X = \text{points/chip}$). Therefore, the decision points are at $0, 1 \times X, 2 \times X, 3 \times X \dots$</p>
4	<p>Phase error trace – returns series of floating point numbers (in degree) that represent each sample in the phase error trace. There are X points per symbol ($X = \text{points/ chip}$). Therefore, the decision points are at $0, 1 \times X, 2 \times X, 3 \times X \dots$</p>

n	Results Returned
5	<p>Corrected measured trace – returns series of floating point numbers that alternately represent I and Q pairs of the corrected measured trace. The magnitude of each I and Q pair are normalized to 1.0. The first number is the in-phase (I) sample of symbol 0 decision point and the second is the quadrature-phase (Q) sample of symbol 0 decision point. There are X points per symbol ($X = \text{points/chip}$), so the series of numbers is:</p> <p style="margin-left: 40px;">1st number = I of the symbol 0 decision point 2nd number = Q of the symbol 0 decision point</p> <p style="margin-left: 40px;">. . . $(2 \times X) + 1$, number = I of the symbol 1 decision point $(2 \times X) + 2$, number = Q of the symbol 1 decision point</p> <p style="margin-left: 40px;">. . . $(2 \times X) \times N\text{th} + 1$ number = I of the symbol N decision point $(2 \times X) \times N\text{th} + 2$ number = Q of the symbol N decision point</p>

Intermodulation Measurement

This measures the third order and fifth order intermodulation products caused by the wanted signal and the interfering signal. You must be in cdma2000, W-CDMA, or 1xEV-DO mode to use these commands. Use INSTRument:SElect to set the mode.

The general functionality of CONFigure, FETCh, MEASure, and READ are described at the beginning of this section. See the SENSE:IM commands for more measurement related commands.

:CONFigure:IM

:INITiate:IM

:FETCh:IM[n]?

:READ:IM[n]?

:MEASure:IM[n]?

Key Path: **Measure, Intermod**

After the measurement is selected, press **Restore Meas Defaults** to restore factory defaults.

Measurement Results Available

n	Results Returned
0	Returns unprocessed I/Q trace data that acquired in the last acquisition when multiple acquisition is performed, as a data array of trace point values, in volts.

n	Results Returned
1 (default)	<p>Returns scalar results in the following order.</p> <ol style="list-style-type: none"> 1. Absolute power of the reference (dBm) 2. Base lower frequency (Hz) 3. Base lower absolute power (dBm) 4. Base lower relative power to the reference (dBc) 5. Base upper frequency (Hz) 6. Base upper absolute power (dBm) 7. Base upper relative power to the reference (dBc) 8. Third order lower frequency (Hz) 9. Third order lower absolute power (dBm) 10. Third order lower relative power to the reference power (dBc) 11. Third order lower power spectrum density (dBm/Hz) 12. Third order upper frequency (Hz) 13. Third order upper absolute power (dBm) 14. Third order upper relative power to the reference power (dBc) 15. Third order upper power spectrum density (dBm/Hz) 16. Fifth order lower frequency (Hz) 17. Fifth order lower absolute power (dBm) 18. Fifth order lower relative power to the reference power (dBc) 19. Fifth order lower power spectrum density (dBm/Hz) 20. Fifth order upper frequency (Hz) 21. Fifth order upper absolute power (dBm) 22. Fifth order upper relative power to the reference power (dBc) 23. Fifth order upper power spectrum density (dBm/Hz) <p>If the results are not available, -999.0 is returned for the power results and 0.0 for the frequency results.</p>
2 cdma2000, 1xEV-DO mode	<p>Returns a series of floating point numbers that represent the frequency-domain spectrum trace for the entire frequency range being measured.</p> <p>In the default settings (SENSE:IM:FREQUENCY:SPAN 20 MHz; SENSE:IM:BANDWIDTH BWIDTH[:RESOLUTION] 140 kHz), there are 345 numbers.</p>
2 W-CDMA mode	<p>Returns a series of floating point numbers that represent the frequency-domain spectrum trace for the entire frequency range being measured.</p> <p>In the default settings (SENSE:IM:FREQUENCY:SPAN 50 MHz; SENSE:IM:BANDWIDTH BWIDTH[:RESOLUTION] 140 kHz), there are 872 numbers.</p>

n	Results Returned
3	<p>Returns 2 scalar values of the measured mode determined by the Auto algorithm.</p> <ol style="list-style-type: none">1. Measurement Mode:<ol style="list-style-type: none">1: Two-tone2: Transmit IM3: Auto (Two-tone)4: Auto (Transmit IM)5: Unknown2. Reference:<ol style="list-style-type: none">1: Lower2: Upper3: Average4: Auto (Lower)5: Auto (Upper)

Multi Carrier Power Measurement

This measures the power levels of two input carriers, out-of-channels from them, and the channels between them. You must be in W-CDMA mode to use these commands. Use INSTRument:SELEct to set the mode.

The general functionality of CONFigure, FETCh, MEASure, and READ are described at the beginning of this section. See the SENSE:MCPower commands for more measurement related commands.

:CONFigure:MCPower

:INITiate:MCPower

:FETCh:MCPower [n] ?

:READ:MCPower [n] ?

:MEASure:MCPower [n] ?

Key Path: **Measure, Multi Carrier Power**

After the measurement is selected, press **Restore Meas Defaults** to restore factory defaults.

Measurement Results Available

n	Results Returned
0	Returns unprocessed I/Q trace data, as a data array of trace point values, in volts.

n	Results Returned
1 (default)	<p>Returns scalar results, in the following order.</p> <ol style="list-style-type: none"> 1. Reference – absolute power (dBm) 2. Center frequency – relative power (dBc) 3. Center frequency – absolute power (dBm) 4. Second carrier frequency – relative power (dBc) 5. Second carrier frequency – absolute power (dBm) 6. –5 MHz offset frequency adjacent to the center frequency – relative power (dBc) 7. –5 MHz offset frequency adjacent to the center frequency – absolute power (dBc) 8. –5 MHz offset frequency adjacent to the second carrier frequency – relative power (dBc) 9. –5 MHz offset frequency adjacent to the second carrier frequency – absolute power (dBc) 10. Reserved for future use, returns –999.0. 11. Reserved for future use, returns –999.0. 12. Reserved for future use, returns –999.0. 13. Reserved for future use, returns –999.0. 14. Negative offset frequency (1) – relative power (dBc) 15. Negative offset frequency (1) – absolute power (dBm) 16. Positive offset frequency (1) – relative power (dBc) 17. Positive offset frequency (1) – absolute power (dBm) 18. Negative offset frequency (2) – relative power (dBc) 19. Negative offset frequency (2) – absolute power (dBm) 20. Positive offset frequency (2) – relative power (dBc) 21. Positive offset frequency (2) – absolute power (dBm) 22. Negative offset frequency (3) – relative power (dBc) 23. Negative offset frequency (3) – absolute power (dBm) 24. Positive offset frequency (3) – relative power (dBc) 25. Positive offset frequency (3) – absolute power (dBm) <p>If the results are not available, –999.0 is returned for the power results and 0.0 for the frequency results.</p>
2	<p>Returns scalar values of the pass/fail (0 for pass, and 1 for fail) results determined by testing the power based on the limit setting.</p> <ol style="list-style-type: none"> 1. –5 MHz offset frequency adjacent to the center frequency 2. –5 MHz offset frequency adjacent to the second carrier frequency 3. Reserved for future use, returns 0.0. 4. Reserved for future use, returns 0.0. 5. Negative offset frequency (1) 6. Positive offset frequency (1) 7. Negative offset frequency (2) 8. Positive offset frequency (2) 9. Negative offset frequency (3) 10. Positive offset frequency (3) <p>If the results are not available, 0.0 is returned.</p>

Occupied Bandwidth Measurement

This measures the bandwidth of the carrier signal in the occupied part of the channel. You must be in the PDC, iDEN (E4406A only), cdma2000, W-CDMA, or 1xEV-DO mode to use these commands. Use INSTRUMENT:SELect to set the mode.

The general functionality of CONFigure, FETCh, MEASure, and READ are described at the beginning of this section. See the SENSE:OBW commands for more measurement related commands.

:CONFigure:OBW

:INITiate:OBW

:FETCh:OBW [n] ?

:READ:OBW [n] ?

:MEASure:OBW [n] ?

History: E4406A:
Version A.02.00 or later

Key Path: **Measure, Occupied BW**

After the measurement is selected, press **Restore Meas Defaults** to restore factory defaults.

Measurement results available

n	Results Returned
0	Returns unprocessed I/Q trace data, as a data array of trace point values, in volts.
1 (default) cdma2000, W-CDMA mode	Returns scalar results, in the following order: 1. Occupied bandwidth - Hz 2. Absolute Carrier Power - dBm
1 (default) PDC	Returns scalar results, in the following order: 1. Occupied bandwidth - kHz 2. Absolute Carrier Power - dBm
1 (default) 1xEV-DO mode	Returns scalar results, in the following order: 1. Occupied bandwidth - Hz 2. Absolute Carrier Power - dBm 3. Span - Hz 4. Spectrum Trace Points - points 5. Res BW - Hz

n	Results Returned
1 (default) iDEN mode E4406A	Returns the following scalar results, in order. <ol style="list-style-type: none"> 1. Absolute power of occupied bandwidth (dBm) 2. Relative power of occupied bandwidth (dB) 3. Bandwidth for specified power percentage 4. Power percentage 5. Measured carrier frequency 6. Frequency span 7. Average count
2 PDC, cdma2000, W-CDMA, 1xEV-DO mode	Returns the frequency-domain spectrum trace (data array) for the entire frequency range being measured.
2, spectrum display only iDEN mode E4406A	Returns the frequency-domain spectrum trace (data array) for the entire frequency range (9003 points) being measured.

Power Control Measurement

This provides three types of measurement as Slot power, PRACH power and Slot phase especially for uplink signal analysis. There are two methods like waveform (asynchronous) and chip power (resampled in chip rate).

The general functionality of CONFigure, FETCh, MEASure, and READ are described at the beginning of this section. See the SENSE:PCON commands for more information.

```
:CONFigure:PCONtrol
:INITiate:PCONtrol
:FETCh:PCONtrol [n] ?
:READ:PCONtrol [n] ?
:MEASure:PCONtrol [n] ?
```

Key Path: **Meas Setup, Meas Type**

Measurement Results Available

Index: n <Mnemonic>	Results Returned
0	Returns unprocessed I/Q trace data, as a series of comma-separated trace points, in volts. The I values are listed first in each pair, using the 0 through even-indexed values. The Q values are the odd-indexed values.

<p>1 (or not specified)</p>	<ol style="list-style-type: none"> 1. Returns the following 6 comma-separated scalar results in the following order: Number of slots is an integer number of the number of slots found in the captured data. (In case of PRACH Power measurement, it always returns 0). 2. Number of PRACH preamble is an integer number to give the number of PRACH preamble burst found in captured data. (In case of Slot measurement, it always returns 0). 3. Number of PRACH Message is an integer number to give the number of PRACH Message found in captured data. (In case of Slot measurement, it always returns 0) This number must be 1 or 0, because once PRACH Message is found, no more PRACH burst search is performed after PRACH Message burst. 4. First Slot Number is an integer number presenting the first slot number in the captured data. The returned value is valid in the following cases. In other cases, the returned value is 0. <ul style="list-style-type: none"> - Meas Type is Slot Phase 5. DPCCH Slot Format is an integer number. <ul style="list-style-type: none"> • If Sync Type is DPCCH and Meas Method is Chip Power, the DPCCH slot format value used for synchronization is returned <ul style="list-style-type: none"> — 0: Slot Format 0 — 1: Slot Format 1 — 2: Slot Format 2 — 3: Slot Format 3 — 4: Slot Format 4 — 5: Slot Format 5 • If Sync Type is PRACH, the value returned is -999 6. Reserved: (integer) The value returned is -999
<p>2</p>	<p>Waveform/ChipPower trace data. Returns comma-separated waveform or chip power trace data (in dBm).</p>
<p>3</p>	<p>Slot Power Measurement trace (Absolute Power Measurement) – returns comma-separated post-processed data trace for measured data. With "Slot Power Measurement" selected, the slot averaged data trace (in dBm) will be returned. (This data trace corresponds 'Result' column in Result Number of slot is given as 1st parameter in :MEASure:PCONTrol:.</p>

4	<p>PRACH Power result – returns comma-separated post-processed data</p> <p>Npreamble: Number of PRACH Preamble</p> <p>1st number: Pre-Burst Off Pwr (float, in dBm) of 1st PRACH preamble</p> <p>2nd number: Burst On Pwr (float, in dBm) of 1st PRACH preamble</p> <p>3rd number: Burst On Pwr relative to the previous data (float, in dB) of 1st PRACH (This returns always 0.0)</p> <p>4th number: Post-Burst Off Pwr (float, in dBm) of 1st PRACH preamble</p> <p>5th number: Time Offset (float, in chip) of 1st PRACH preamble This returns always 0.0)</p> <p>...</p> <p>(N-1)Y5+1: Pre-Burst Off Pwr (float, in dBm) of Nth PRACH preamble</p> <p>(N-1)Y5+2: Burst On Pwr (float, in dBm) of Nth PRACH preamble</p> <p>(N-1)Y5+3: Burst On Pwr relative to the previous data (float, in dB) of Nth PRACH preamble</p> <p>(N-1)Y5+4: Post-Burst Off Pwr (float, in dBm) of Nth PRACH preamble</p> <p>N¥5: Time Offset (float, in chip) of Nth PRACH preamble</p> <p>...</p> <p>(Npreamble -1)Y5+1: Pre-Burst Off Pwr (float, in dBm) of Npreambleth PRACH preamble</p> <p>(Npreamble -1)Y5+2: Burst On Pwr (float, in dBm) of Npreambleth PRACH preamble</p> <p>(Npreamble -1)Y5+3: Burst On Pwr relative to the previous data (float, in dB) of Npreambleth PRACH preamble</p> <p>(Npreamble -1)Y5+4: Post-Burst Off Pwr (float, in dBm) of Npreambleth PRACH preamble</p> <p>Npreamble¥5: Time Offset (float, in chip) of Npreambleth PRACH preamble</p> <p>Npreamble¥5+1: Pre-Burst Off Pwr (float, in dBm) of PRACH Message (if available)</p> <p>Npreamble¥5+2: Burst On Pwr (float, in dBm) of PRACH Message (if available)</p> <p>Npreamble¥5+3: Burst On Pwr relative to the previous data (float, in dB) PRACH Message (if available)</p> <p>Npreamble¥5+4: Post-Burst Off Pwr (float, in dBm) of PRACH Message (if available)</p> <p>Npreamble¥5+5: Time Offset (float, in chip) of PRACH Message (if available)</p>
---	--

5	<p>Slot Power Measurement trace (Relative Power measurement –1) – returns comma-separated post-processed data trace for measured data. With "Slot Power Measurement" selected, the relative power with the previous slot data trace (in dB) will be returned. (This data trace corresponds 'Delta Adj Pwr' column in Result window.) The first data returns always '0.0'.</p> <p>The number of slot is given as 1st parameter in :MEASure:PCONTrol?.</p>
6	<p>Slot Power Measurement trace (Relative Power Measurement – 2) – returns comma-separated post-processed data trace for measured data. With "Slot Power Measurement" selected, the relative power level with the first slot (in dB) will be returned. (This data trace corresponds to the 'Rel Pwr' column in the Results window.) The first data returns always '0.0'.</p> <p>The number of slots is the first parameter from :MEASure:PCONTrol?.</p>
7	<p>Chip by chip phase error trace.</p> <p>It returns a series of floating point numbers (in degree) that represents chip by chip phase error.</p> <p>The number of values returned is equal to the number of chips in the capture interval.</p>
8	<p>Chip phase error best-fit line.</p> <p>It returns a series of floating point numbers (in degree) that represents best-fit phase line of chips to minimize the EVM of the slot.</p> <p>The number of values returned is equal to the number of chips in the capture interval.</p>
9	<p>Slot Phase Discontinuity.</p> <p>It returns a series of floating point numbers (in degree) that represents phase difference between the end of the previous slot and the beginning of the slot.</p> <p>The number of values returned is equal to the number of slots in the capture interval.</p>
10	<p>Slot phase error from the reference phase at the beginning of the slot.</p> <p>It returns a series of floating point numbers (in degree) that represents absolute phase error at the beginning of each slot.</p> <p>The number of values returned is equal to the number of slots in the capture interval.</p>
11	<p>RMS EVM of slots based on the best-fit line.</p> <p>It returns a series of floating point numbers (in degree) that represents RMS EVM of each slot excluding 25us at the beginning and tail of the slot.</p> <p>The number of values returned is equal to the number of slots in the capture interval.</p>

12	<p>RMS Magnitude error of slots.</p> <p>It returns a series of floating point numbers (in degree) that represents RMS Magnitude error of each slot excluding 25us at the beginning and end of the slot.</p> <p>The number of values returned is equal to the number of slots in the capture interval.</p>
13	<p>RMS Phase error of slot.</p> <p>It returns a series of floating point numbers (in degree) that represents frequency error of each slot, which is an element of the RMS EVM.</p> <p>The number of values returned is equal to the number of slots in the capture interval.</p>
14	<p>IQ Offset of slots.</p> <p>It returns a series of floating point numbers (in dB) that represents IQ Origin Offset of each slot, which is an element of the RMS EVM.</p> <p>The number of values returned is equal to the number of slots in the capture interval.</p>
15	<p>Frequency error of the best-fit line for slots.</p> <p>It returns a series of floating point numbers (in Hz) that represents frequency error of each slot, which is equivalent to the amount of the slope of the best-fit line and frequency error of the reference frequency that measurement algorithm determines for synchronization, and an element of the RMS EVM</p> <p>The number of values returned is equal to the number of slots in the capture interval.</p>

Power Statistics CCDF Measurement

For E4406A this is a statistical power measurement of the complementary cumulative distribution function (CCDF). You must be in the Basic, cdma2000, W-CDMA, or 1xEV-DO mode to use these commands. Use INSTRument:SElect to set the mode.

For PSA this is a statistical power measurement of the complementary cumulative distribution function (CCDF). You must be in the cdma2000, W-CDMA, or 1xEV-DO mode to use these commands. Use INSTRument:SElect to set the mode.

The general functionality of CONFigure, FETCh, MEASure, and READ are described at the beginning of this section. See the SENSE:PStat commands for more measurement related commands.

```
:CONFigure:PStatistic
:INITiate:PStatistic
:FETCh:PStatistic [n] ?
:READ:PStatistic [n] ?
:MEASure:PStatistic [n] ?
```

History: Version A.03.00 or later, added in Basic A.04.00

Key Path: **Measure, Power Stat CCDF**

After the measurement is selected, press **Restore Meas Defaults** to restore factory defaults.

Measurement Results Available

n	Results Returned
0	Returns unprocessed I/Q trace data, as a series of trace point values, in volts. The I values are listed first in each pair, using the 0 through even-indexed values. The Q values are the odd-indexed values,
n=1 (or not specified)	Returns scalar results: <ol style="list-style-type: none"> 1. Average input power (in dBm) 2. Probability at the average input power level (in %) 3. Power level that has 10% of the power 4. Power level that has 1% of the power 5. Power level that has 0.1% of the power 6. Power level that has 0.01% of the power 7. Power level that has 0.001% of the power 8. Power level that has 0.0001% of the power 9. Peak power (in dB) 10. Count

n	Results Returned
2	<p>Returns a series of 5001 floating point numbers (in percent) that represent the current measured power stat trace. This is the probability at particular power levels (average power), in the following order:</p> <ol style="list-style-type: none"> 1. Probability at 0.0 dB power 2. Probability at 0.01 dB power 3. Probability at 0.02 dB power <p style="text-align: center;">. . .</p> <ol style="list-style-type: none"> 1. Probability at 49.9 dB power 2. Probability at 50.0 dB power
3	<p>Returns a series of 5001 floating point numbers (in percent) that represent the Gaussian trace. This is the probability at particular power levels (average power), in the following order:</p> <ol style="list-style-type: none"> 1. Probability at 0.0 dB power 2. Probability at 0.01 dB power 3. Probability at 0.02 dB power <p style="text-align: center;">. . .</p> <ol style="list-style-type: none"> 1. Probability at 49.9 dB power 2. Probability at 50.0 dB power
4	<p>Returns a series of 5001 floating point numbers (in percent) that represent the user-definable reference trace. This is the probability at particular power levels (average power), in the following order:</p> <ol style="list-style-type: none"> 1. Probability at 0.0 dB power 2. Probability at 0.01 dB power 3. Probability at 0.02 dB power <p style="text-align: center;">. . .</p> <ol style="list-style-type: none"> 1. Probability at 49.9 dB power 2. Probability at 50.0 dB power

Power vs. Time Measurement

For E4406A this measures the average power during the “useful part” of the burst comparing the power ramp to required timing mask. You must be in EDGE, GSM, 1xEV-DO or Service mode to use these commands. Use INSTRument:SElect to set the mode.

For PSA this measures the average power during the “useful part” of the burst comparing the power ramp to required timing mask. You must be in GSM(w/EDGE), or 1xEV-DO mode to use these commands. Use INSTRument:SElect to set the mode.

The general functionality of CONFigure, FETCh, MEASure, and READ are described at the beginning of this section. See the SENSE:PVTime commands for more measurement related commands.

:CONFigure:PVTime

:INITiate:PVTime

:FETCh:PVTime [n] ?

:READ:PVTime [n] ?

:MEASure:PVTime [n] ?

Key Path: **Measure, Power vs Time**

After the measurement is selected, press **Restore Meas Defaults** to restore factory defaults.

History: Modified in version A.05.00..

Measurement Results Available

n	Results Returned
0	Returns unprocessed I/Q trace data, as a series of trace point values, in volts. The I values are listed first in each pair, using the 0 through even-indexed values. The Q values are the odd-indexed values.

n	Results Returned
n=1 (or not specified)	<p>Returns the following scalar results:</p> <ol style="list-style-type: none"> 1. Sample time is a floating point number that represents the time between samples when using the trace queries (n=0,2,etc.). 2. Power of single burst is the mean power (in dBm) across the useful part of the selected burst in the most recently acquired data, or in the last data acquired at the end of a set of averages. If averaging is on, the power is for the last burst. 3. Power averaged is the power (in dBm) of N averaged bursts, if averaging is on. The power is averaged across the useful part of the burst. Average <i>m</i> is a single burst from the acquired trace. If there are multiple bursts in the acquired trace, only one burst is used for average <i>m</i>. This means that N traces are acquired to make the complete average. If averaging is off, the value of power averaged is the same as the power single burst value. 4. Number of samples is the number of data points in the captured signal. This number is useful when performing a query on the signal (i.e. when n=0,2,etc.). 5. Start point of the useful part of the burst is the index of the data point at the start of the useful part of the burst 6. Stop point of the useful part of the burst is the index of the data point at the end of the useful part of the burst 7. Index of the data point where T_0 occurred. 8. Burst width of the useful part of the burst is the width of the burst measured at -3dB below the mean power in the useful part of the burst. 9. Maximum value is the maximum value of the most recently acquired data (in dBm). 10. Minimum value is the minimum value of the most recently acquired data (in dBm). 11. Burst search threshold is the value (in dBm) of the threshold where a valid burst is identified, after the data has been acquired. 12. IQ point delta is the number of data points offset that are internally applied to the useful data in traces n=2,3,4. You must apply this correction value to find the actual location of the Start, Stop, or T_0 values.

n	Results Returned
n=1 (or not specified) 1xEV-DO or W-CDMA mode	<p>Returns the following scalar results:</p> <ol style="list-style-type: none"> 1. Sample time is a floating point number that represents the time between samples when using the trace queries (where n = 0, 2, etc.). 2. Power of single burst is the mean power (in dBm) across the useful part of the selected burst in the most recently acquired data, or in the last data acquired at the end of a set of averages. If averaging is on, the power is for the last burst. 3. Power averaged is the power (in dBm) of N averaged bursts, if averaging is on. The power is averaged across the useful part of the burst. Average m is a single burst from the acquired trace. If there are multiple bursts in the acquired trace, only one burst is used for average m. This means that N traces are acquired to make the complete average. If averaging is off, the value of power averaged is the same as the power single burst value. 4. Number of samples (N) is the number of data points in the captured signal. This number is useful when performing a query on the signal (i.e. when n = 0, 2, etc.). 5. Start point of the useful part of the burst is the index of the data point at the start of the useful part of the burst 6. Stop point of the useful part of the burst is the index of the data point at the end of the useful part of the burst 7. Index of the data point where T₀ occurred. 8. Burst width of the useful part of the burst is the width of the burst measured at -3dB below the mean power in the useful part of the burst. 9. Maximum value is the maximum value of the most recently acquired data (in dBm). 10. Minimum value is the minimum value of the most recently acquired data (in dBm). 11. Burst search threshold is the value (in dBm) of the threshold where a valid burst is identified, after the data has been acquired. 12. Averaged number (N) is used to average the measurement results. 13. First position in index to exceed the limit (N) is ? 14. Reserved for future use, returns -999.0. 15. Reserved for future use, returns -999.0. 16. Reserved for future use, returns -999.0. 17. Absolute power in the region A (dBm) 18. Absolute power in the region B (dBm) 19. Absolute power in the region C (dBm) 20. Absolute power in the region D (dBm) 21. Absolute power in the region E (dBm) 22. Relative power in the region A (dB) 23. Relative power in the region B (dB) 24. Relative power in the region C (dB) 25. Relative power in the region D (dB)

n	Results Returned
n=1 (or not specified) (cont.) 1xEV-DO or W-CDMA mode	26. Relative power in the region E (dB) 27. Maximum absolute power in the region A (dBm) 28. Maximum absolute power in the region B (dBm) 29. Maximum absolute power in the region C (dBm) 30. Maximum absolute power in the region D (dBm) 31. Maximum absolute power in the region E (dBm) 32. Maximum relative power in the region A (dB) 33. Maximum relative power in the region B (dB) 34. Maximum relative power in the region C (dB) 35. Maximum relative power in the region D (dB) 36. Maximum relative power in the region E (dB) 37. Minimum absolute power in the region A (dBm) 38. Minimum absolute power in the region B (dBm) 39. Minimum absolute power in the region C (dBm) 40. Minimum absolute power in the region D (dBm) 41. Minimum absolute power in the region E (dBm) 42. Minimum relative power in the region A (dB) 43. Minimum relative power in the region B (dB) 44. Minimum relative power in the region C (dB) 45. Minimum relative power in the region D (dB) 46. Minimum relative power in the region E (dB)
2	Returns trace point values of the entire captured I/Q trace data. These data points are floating point numbers representing the power of the signal (in dBm). There are N data points, where N is the number of samples . The period between the samples is defined by the sample time .
3	Returns data points representing the upper mask (in dBm).
4	Returns data points representing the lower mask (in dBm).
6 W-CDMA mode	Returns 5 comma-separated scalar values of the pass/fail (0.0=passed, or 1.0=failed) results determined by testing the upper mask.
7 W-CDMA mode	Returns 5 comma-separated scalar values of the pass/fail (0.0=passed, or 1.0=failed) results determined by testing the lower mask:
7 EDGE, GSM, Service mode (E4406A only) GSM (/EDGE) mode (PSA only)	Returns power level values for the 8 slots in the current frame (in dBm).

Modulation Accuracy (Rho) Measurement

This measures the modulation accuracy of the transmitter by checking the magnitude and phase error and the EVM (error vector magnitude). You must be in the cdmaOne, cdma2000, W-CDMA, or 1xEV-DO mode to use these commands. Use INSTRument:SElect to set the mode.

For 1xEV-DO: these commands will measure modulation accuracy on network access equipment (base transmitter stations). Use MEAS:TRHO to measure terminal transmitter modulation accuracy, after selecting mobile stations using SENSE:RADio:DEvice MS.

The general functionality of CONFigure, FETCh, MEASure, and READ are described at the beginning of this section. See the SENSE:RHO commands for more measurement related commands.

:CONFigure:RHO

:INITiate:RHO

:FETCh:RHO [n] ?

:READ:RHO [n] ?

:MEASure:RHO [n] ?

Key Path: **Measure, Mod Accuracy (Rho)** for cdmaOne

Measure, Mod Accuracy (Composite Rho) for cdma2000, 1xEV-DO, or W-CDMA (3GPP)

After the measurement is selected, press **Restore Meas Defaults** to restore factory defaults.

Measurement Results Available

n	Results Returned
0 cdmaOne mode	Returns unprocessed I/Q trace data, as a series of trace point values. The I values are listed first in each pair, using the 0 through even-indexed values. The Q values are the odd-indexed values. The standard sample rate is 7.5 MHz and the trace length is determined by the current measurement interval.
0 cdma2000 or W-CDMA mode	Returns unprocessed I/Q trace data, as a series of trace point values. The I values are listed first in each pair, using the 0 through even-indexed values. The Q values are the odd-indexed values.

n	Results Returned
n=1 (or not specified) cdmaOne mode	<p>Returns floating point numbers, in the following order:</p> <ol style="list-style-type: none"> 1. Rho (no units) represents the correlation of the measured power compared to the ideal pilot channel. The calculation is performed after the complementary filter, so it is IS95 compliant. It is performed at the decision points in the pilot waveform. If averaging is on, this is the average of the individual rms measurements. 2. Time offset (with units of seconds) is the time delay of the even second clock with respect to the start of the short code PN sequences, at offsets from the 15 zeros in the characteristic phase of the sequence. 3. Frequency error of the measured signal, with units of Hz. This is based on the linear best fit of the uncorrected measured phase. 4. Carrier feedthrough has units of dB and is the dc error offset of I and Q, from the origin. 5. EVM has units of percent. The calculation is based on the composite of the phase error and magnitude error, between the measured signal and the ideal pilot channel. It is performed after the complementary filter which removes the inter-symbol interference in the modulated data. If averaging is on, this is the average of the individual rms measurements. 6. Magnitude error (with units of percent) is the rms error between the measured (compensated) magnitude and the ideal magnitude. This is performed after the complementary filter which removes the inter-symbol interference in the modulated data. If averaging is on, this is the average of the individual rms measurements. 7. Phase error (with units in percent) is the rms phase error between the measured phase and the ideal phase. The calculation is performed after the complementary filter which removes the inter-symbol interference in the modulated data. If averaging is on, this is the average of the individual rms measurements.

n	Results Returned
n=1 (or not specified) cdma2000	<p>Returns scalar results, in the following order.</p> <ol style="list-style-type: none"> 1. RMS EVM is a floating point number (in percent) of EVM over the entire measurement area 2. Peak EVM is a floating point number (in percent) of peak EVM in the measurement area 3. Magnitude error is a floating point number (in percent) of average magnitude error over the entire measurement area 4. Phase error is a floating point number (in degree) of average phase error over the entire measurement area 5. I/Q origin offset is a floating point number (in dB) of the I and Q error (magnitude squared) offset from the origin 6. Frequency error is a floating point number (in Hz) of the frequency error in the measured signal 7. Rho is a floating point number of Rho 8. Peak code domain error is a floating point number (in dB) of the Peak Code Domain Error relative to the mean power 9. Peak code domain error channel number is the channel number in which the peak code domain error is detected at the max spreading factor. <p>NOTE: For MS measurements of Q channel numbers, subtract 32 from the number returned by SCPI query to obtain the actual channel number. For example, if the front panel displayed result is "W32 (15) :Q", then the SCPI query result will be "47". As $47 - 32 = 15$, 15 is the actual Peak CDE channel number result.</p> <p>For I channel MS measurements, as well as both I and Q channel BTS measurements, the returned number is the actual Peak CDE channel number.</p> <ol style="list-style-type: none"> 10. Number of active channels. 11. Time offset is a floating point number (in second) PN offset from the trigger point.

n	Results Returned
<p>n=1 (or not specified) W-CDMA mode</p>	<p>Returns the following 14 comma-separated scalar results:</p> <ol style="list-style-type: none"> 1. RMS EVM (Average) is a floating point number (in percent) of EVM over the entire measurement area 2. Peak EVM (Peak Hold) is a floating point number (in percent) of peak EVM in the measurement area 3. Magnitude error (Average) is a floating point number (in percent) of average magnitude error over the entire measurement area 4. Phase error (Average) is a floating point number (in degree) of average phase error over the entire measurement area 5. I/Q origin offset (Average) is a floating point number (in dB) of the I and Q error (magnitude squared) offset from the origin 6. Frequency error (Average) is a floating point number (in Hz) of the frequency error in the measured signal 7. Rho (Average) is a floating point number of Rho 8. Peak Code Domain Error (Peak Hold) is a floating point number (in dB) of the Peak Code Domain Error relative to the mean power 9. Peak Code Domain Error Channel Number (Peak Hold) is the channel number in which the peak code domain error is detected. 10. Number of active channels. (Average) 11. Time offset (Average) is a floating points number (in chip) of the pilot phase timing from the acquisition trigger point. 12. CPICH power over a slot (Average) is a floatings point number in dB of CPICH power over a measurement slot. In the MS mode the value returned is -999. 13. Total power over a slot (Average) is a floating points number in dBm of total RF power over a measurement slot. 14. First Slot Number. It is an integer number of first slot in Capture Interval. This is not averaged even if averaging is On. It is always the last cycle of the measurement. 15. DPCCH Slot Format (Latest) is an integer number. <ul style="list-style-type: none"> - If Sync Type is DPCCH, the DPCCH slot format value used for synchronization is returned. <ul style="list-style-type: none"> 0: Slot Format 0 1: Slot Format 1 2: Slot Format 2 3: Slot Format 3 4: Slot Format 4 5: Slot Format 5 - If Sync Type is PRACH, the value returned is -999. - In BTS mode, the value returned is -999. 16. Reserved: (integer) The value returned is -999.

n	Results Returned
<p>n=1 (or not specified)</p> <p>1xEV-DO mode</p> <p>For base stations: SENS:RAD:DEV BTS</p> <p>For meas type: CALC:RHO:TYPE DATA MAC PILot PREamble</p>	<p>Returns the following comma-separated scalar results, in the following order:</p> <p>(NOTE: Returns ONLY the following 9 comma-separated scalar results, in the following order, for base transmitter station measurements when the type is <i>NOT</i> set to ALL.)</p> <ol style="list-style-type: none"> 1. RMS EVM – a floating point number (in percent) of EVM over the entire measurement area. 2. Peak EVM error – a floating point number (in percent) of peak EVM in the measurement area. 3. Magnitude error – a floating point number (in percent) of average magnitude error over the entire measurement area. 4. Phase error – a floating point number (in degree) of average phase error over the entire measurement area. 5. I/Q Origin Offset – a floating point number (in dB) of the I and Q error (magnitude squared) offset from the origin. 6. Frequency error – a floating point number (in Hz) of the frequency error in the measured signal. 7. Rho – a floating point number of Rho. 8. Number of active channels. 9. Time offset is the time from the trigger to the PN offset – a floating point number (in micro seconds) of PN offset from the trigger point.

n	Results Returned
<p>n=1 (or not specified)</p> <p>1xEV-DO mode</p> <p>For base stations: SENS:RAD:DEV BTS</p> <p>For meas type ALL: CALC:RHO:TYPE ALL</p>	<p>Returns the following scalar results for base transmitter station measurements when the type is set to ALL.</p> <p>Rho Overall-1 and Rho Overall-2 specified in 3GPP2 TSG-C4.1 Recommended Minimum Performance Standard for cdma2000 High Rate Data Packet Access Network, 11.4.2 Waveform Quality Measurement section.</p> <ol style="list-style-type: none"> 10. RMS EVM (Overall-1) – a floating point number (in percent) of EVM over the entire measurement area. 11. Peak EVM error (Overall-1) – a floating point number (in percent) of peak EVM in the measurement area. 12. Magnitude error (Overall-1) – a floating point number (in percent) of average magnitude error over the entire measurement area. 13. Phase error (Overall-1) – a floating point number (in degree) of average phase error over the entire measurement area. 14. I/Q Origin Offset (Overall-1) – a floating point number (in dB) of the I and Q error (magnitude squared) offset from the origin. 15. Frequency error (Overall-1) – a floating point number (in Hz) of the frequency error in the measured signal. 16. Rho (Overall-1) – a floating point number of Rho. 17. RMS EVM (Overall-2) – a floating point number (in percent) of EVM over the entire measurement area. 18. Peak EVM error (Overall-2) – a floating point number (in percent) of peak EVM in the measurement area. 19. Magnitude error (Overall-2) – a floating point number (in percent) of average magnitude error over the entire measurement area. 20. Phase error (Overall-2) – a floating point number (in degree) of average phase error over the entire measurement area. 21. I/Q Origin Offset (Overall-2) – a floating point number (in dB) of the I and Q error (magnitude squared) offset from the origin. 22. Frequency error (Overall-2) – a floating point number (in Hz) of the frequency error in the measured signal. 23. Rho (Overall-2) – a floating point number of Rho. 24. Number of active channels in Pilot 25. Number of active channels in Mac 26. Number of active channels in Data 27. Preamble Length 28. MAC Index 29. Number of Max MAC Inactive channel Power – a floating point number (in dB) of Maximum MAC Inactive Channel Power channels in Data 30. Max Data Active Channel Power – a floating point number (in dB) of Maximum Data Active Channel Power 31. Min Data Active Channel Power – a floating point number (in dB) of Minimum Data Active Channel Power

n	Results Returned
2 cdmaOne mode	EVM trace – returns error vector magnitude (EVM) data, as trace point values in percent. The first value is the chip 0 decision point. The trace is interpolated for the currently selected points/chips displayed on the front panel. The number of trace points depends on the current measurement interval setting.
2 cdma2000 mode	EVM trace – returns series of floating point numbers (in percent) that represent each sample in the EVM trace. The first number is the symbol 0 decision point. There are X points per symbol ($X = \text{points/chip}$). Therefore, the decision points are at $0, 1 \times X, 2 \times X, 3 \times X \dots$
2 W-CDMA mode	Chip EVM: EVM trace returns series of floating point numbers (in percent) that represent EVM of chips for Capture Interval. The length of the trace depends on Capture Interval.
2 1xEV-DO mode	Returns series of floating point numbers (in percent) that represent each sample in the EVM trace. The first number is the symbol 0 decision point and there are X points per symbol. Therefore, the decision points are at $0, 1xX, 2xX, 3xX\dots$ ($X = \text{the number of points per chip}$) This traces is available when the Measurement Channel Type Selection is Pilot, MAC or Data (CALCulate:RHO:TYPE = PILot MAC DATA) In all cases, returns one full slot data points, but only portion of EVM computation is performed are valid. All other portion is 0.0
3 cdmaOne mode	Magnitude error trace – returns magnitude error data, as trace point values, in percent. The first value is the chip 0 decision point. The trace is interpolated for the currently selected points/chips displayed on the front panel. The number of trace points depends on the current measurement interval setting.
3 cdma2000 or 1xEV-DO mode	Magnitude error trace – returns series of floating point numbers (in percent) that represent each sample in the magnitude error trace. The first number is the symbol 0 decision point. There are X points per symbol ($X = \text{points/chip}$). Therefore, the decision points are at $0, 1 \times X, 2 \times X, 3 \times X \dots$ For 1xEV-DO: this traces is available when the Measurement Channel Type Selection is Pilot, MAC or Data (CALCulate:RHO:TYPE = PILot MAC DATA) In all cases, returns one full slot data points, but only portion of EVM computation is performed are valid. All other portion is 0.0
3 W-CDMA mode	Chip Magnitude Error: Magnitude error trace returns series of floating point numbers (in percent) that represent magnitude error of chips for Capture Interval. The length of the trace depends on Capture Interval.

n	Results Returned
4 cdmaOne mode	Phase error trace – returns phase error data, as trace point values, in degrees. The first value is the symbol 0 decision point. The trace is interpolated for the currently selected chips/symbol displayed on the front panel. The number of trace points depends on the current measurement interval setting.
4 cdma2000, W-CDMA, or 1xEV-DO mode	<p>Phase error trace – returns series of floating point numbers (in degrees) that represent each sample in the phase error trace. There are X points per symbol ($X = \text{points}/\text{chip}$). Therefore, the decision points are at $0, 1 \times X, 2 \times X, 3 \times X \dots$</p> <p>For 1xEV-DO: this traces is available when the Measurement Channel Type Selection is Pilot, MAC or Data (CALCulate:RHO:TYPE = PILOt MAC DATA) In all cases, returns one full slot data points, but only portion of EVM computation is performed are valid. All other portion is 0.0</p>
4 W-CDMA mode	<p>Chip Phase Error:</p> <p>Phase error trace returns series of floating point numbers (in degrees) that represent phase error of chips for Capture Interval.</p> <p>The length of the trace depends on Capture Interval.</p>
5 cdmaOne mode	<p>Corrected measured data – returns a series of floating point numbers that alternately represent I and Q pairs of the corrected measured trace data. The magnitude of each I and Q pair are normalized to 1.0.</p> <p>The number of trace points depends on the current measurement interval setting.</p> <p>The numbers are sent in the following order:</p> <ul style="list-style-type: none"> In-phase (I) sample, of symbol 0 decision point Quadrature-phase (Q) sample, of symbol 0 decision point ... In-phase (I) sample, of symbol 1 decision point Quadrature-phase (Q) sample, of symbol 1 decision point ... <p>The trace can be interpolated to 2,4, 8 points/chip selected with the display Points/Chip softkey. This will change the number of points between decision points in the trace, changing the number of I/Q pairs sent for each decision point.</p>

n	Results Returned
<p>5 cdma2000, 1xEV-DO mode</p>	<p>Corrected measured trace – returns series of floating point numbers that alternately represent I and Q pairs of the corrected measured trace. The magnitude of each I and Q pair are normalized to 1.0. The first number is the in-phase (I) sample of symbol 0 decision point and the second is the quadrature-phase (Q) sample of symbol 0 decision point. There are X points per symbol ($X = \text{points/chip}$), so the series of numbers is:</p> <p style="padding-left: 40px;">1st number = I of the symbol 0 decision point 2nd number = Q of the symbol 0 decision point</p> <p style="padding-left: 40px;">. . . $(2 \times X) + 1$, number = I of the symbol 1 decision point $(2 \times X) + 2$, number = Q of the symbol 1 decision point</p> <p style="padding-left: 40px;">. . . $(2 \times X) \times N\text{th} + 1$ number = I of the symbol N decision point $(2 \times X) \times N\text{th} + 2$ number = Q of the symbol N decision point</p> <p>For 1xEV-DO: this traces is available when the Measurement Channel Type Selection is Pilot, MAC or Data (CALCulate:RHO:TYPE = PIlot MAC DATA) In all cases, returns one full slot data points, but only portion of EVM computation is performed are valid. All other portion is 0.0</p>
<p>5 W-CDMA mode</p>	<p>Corrected Measured Trace:</p> <p>Corrected measured trace of Single Slot specified by Meas Offset returns series of floating point numbers that alternately represent I and Q pairs of the corrected measured trace. The magnitude of each I and Q pair are normalized to 1.0.</p> <p style="padding-left: 40px;">1st number = I of the 1st chip 2nd number = Q of the 1st chip 3rd number = I of the 2nd chip 4th number = Q of the 2nd chip</p> <p style="padding-left: 40px;">. . .</p> <p style="padding-left: 40px;">$(2Y\text{N} - 1)$ th number = I of the Nth chip $(2Y\text{N})$ th number = Q of the Nth chip</p>

n	Results Returned
6 cdmaOne mode	<p>Reference IQ data – returns a series of floating point numbers that alternately represent I and Q pairs of the reference trace data.</p> <p>The number of trace points depends on the current measurement interval and points per chip settings.</p> <p>The numbers are sent in the following order:</p> <ul style="list-style-type: none"> In-phase (I) sample, of symbol 0 decision point Quadrature-phase (Q) sample, of symbol 0 decision point ... In-phase (I) sample, of symbol 1 decision point Quadrature-phase (Q) sample, of symbol 1 decision point ... <p>The trace can be interpolated to 2,4,8 points/chip selected with the display Points/Chip softkey.</p>
6 cdma2000 mode	<p>Returns scalar values of the pass/fail (0=passed, or 1=failed) results determined by testing the EVM and peak EVM.</p> <ol style="list-style-type: none"> 1. Test result of EVM 2. Test result of Peak EVM 3. Test result of Rho 4. Test result of Peak Code Domain Error 5. Test result of Time Offset 6. Test result of Phase Error
6 1xEV-DO mode	<p>The same as n=2. (Overall-1)</p> <p>This trace is available when the Measurement Channel Type Selection is All (CALCulate:RHO:TYPE = ALL)</p> <p>(Rho Overall-1 and Rho Overall-2 as specified in 3GPP2 TSG-C4.1 Recommended Minimum Performance Standard for cdma2000 High Rate Data Packet Access Network, 11.4.2 Waveform Quality Measurement section.)</p> <p>n=6, 7, 8, 9 are for Overall-1 data trace n=10, 11, 12, 13 are for Overall-2 data trace</p> <p>In all cases, returns one full slot data points, but only portion of EVM computation is performed are valid. All other portion is 0.0</p>

n	Results Returned
6 W-CDMA mode	<p>PASS/FAIL:</p> <p>Returns 6 comma-separated scalar values of the pass/fail (0.0 = passed, or 1.0 = failed) results determined by testing the following items. And the pass/fail is for the peak-hold value. Because the test on peak-hold value should be server than the average value. Regarding the case that it passes on peak-hold but fails on the average, it definitely does not happen.</p> <ol style="list-style-type: none"> 1. Test result of EVM 2. Test result of Peak EVM 3. Test result of Rho 4. Test result of Peak Code Domain Error 5. Test result of Frequency Error 6. Test result of CPICH over a frame (If MS is selected, this always returns 0.0.)
7 cdmaOne mode	<p>complementary filtered measured data – returns a series of floating point numbers that alternately represent I and Q pairs of the complementary filtered measured data. This is inverse filtered data of the inter-symbol interference in CDMA signals due to the digital transmission filters defined in the standard as well as the base station phase equalization filter.</p> <p>The number of trace points depends on the current measurement interval setting.</p> <p>The numbers are sent in the following order:</p> <p style="padding-left: 40px;">In-phase (I) sample, of symbol 0 decision point Quadrature-phase (Q) sample, of symbol 0 decision point ... In-phase (I) sample, of symbol 1 decision point Quadrature-phase (Q) sample, of symbol 1 decision point ...</p> <p>The trace can be interpolated to 2,4,8 points/chip selected with the display Points/Chip softkey. This will change the number of points between decision points in the trace, changing the number of I/Q pairs sent for each decision point.</p>
7 cdma2000 mode	<p>Returns series of floating point numbers of code level, code index, power (in dB), time offset (in ns), phase offset (in rad), and code domain error (in dB). The total number of results are six times of “number of active channels”. The number of active channels can be obtained by the 10th result of FETCh:RHO0 command.</p>

n	Results Returned
<p>7 1xEV-DO mode</p>	<p>The same as n=3. (Overall-1)</p> <p>This trace is available when the Measurement Channel Type Selection is All (CALCulate:RHO:TYPE = ALL)</p> <p>(Rho Overall-1 and Rho Overall-2 as specified in 3GPP2 TSG-C4.1 Recommended Minimum Performance Standard for cdma2000 High Rate Data Packet Access Network, 11.4.2 Waveform Quality Measurement section.)</p> <p>n=6, 7, 8, 9 are for Overall-1 data trace n=10, 11, 12, 13 are for Overall-2 data trace</p> <p>In all cases, returns one full slot data points, but only portion of EVM computation is performed are valid. All other portion is 0.0</p>
<p>7 W-CDMA mode</p>	<p>Active Channel List:</p> <p>In BTS mode, it returns a series of floating point numbers: symbol rate (ex. 7.5 ksps), OVSF code number, a dummy value, power level and code domain error for the active channels for Single Slot specified by Meas Offset.</p> <p>In MS mode, it returns a series of floating point numbers: symbol rate (ex. 15 ksps), OVSF code number, 1.0 (I) or 1.0 (Q), power level and code domain error for the active channels for Single Slot specified by Meas Offset The results look like the following:</p> <p>1st number = Symbol Rate for 1st Active Channel 2nd number = OVSF Code number for 1st Active Channel 3rd number = (in BTS) 999, or (in MS) either +1 (I) or 1 (Q) for 1st Active Channel 4th number = Power Level (in dB) for 1st Active Channel 5th number = Code Domain Error for 1st Active Channel ... (N-1)Y5+1 number = Symbol Rate for Nth Active Channel (N-1)Y5+2 number = OVSF Code number for Nth Active Channel (N-1)Y5+3 number = 999 (in BTS), or either +1 (I) or 1 (Q) (in MS) for Nth Active Channel (N-1)Y5+4 number = Power Level (in dB) for Nth Active Channel NY5 number = Code Domain Error for Nth Active Channel</p> <p>Number of active channel is given by 10th parameter of :MEASure:RHO[1].</p>

n	Results Returned
<p>8 cdmaOne mode</p>	<p>Code Domain Power:</p> <p>Returns a series of floating point numbers (in dB) that represents all the code domain powers of Single Slot specified by Meas Offset.</p> <p>In BTS mode, there are 512 numbers. If the active channel occupies more than the max spreading factor (7.5 kps) the power is duplicated (active symbol rate / 7.5 kps) times.</p> <p>1st number = 1st code power over the slot 2nd number = 2nd code power over the slot ... Nth number = Nth code power over the slot</p> <p>In MS mode, there are 256 I/Q pairs. If the active channel occupies more than the max spreading factor (15 kps) the power is duplicated (active symbol rate / 15 kps) times.</p> <p>1st number = 1st in-phase code power over a slot 2nd number = 1st quad-phase code power over a slot ... (2Y N + 1) th number = Nth in-phase code power over a slot (2Y N) th number = Nth quad-phase code power over a slot</p>

n	Results Returned
<p>8 W-CDMA mode</p>	<p>Returns a series of floating point numbers (in dB) that represents all the code domain powers of Single Slot specified by Meas Offset.</p> <p>With a device of BTS, there are 512 numbers. If the active channel occupies more than the max spreading factor (7.5 ksps) the power is duplicated (active symbol rate/7.5 ksps) times.</p> <p>1st number = 1st code power over the slot 2nd number = 2nd code power over the slot ... Nth number = Nth code power over the slot</p> <p>With a device of MS, there are 256 I/Q pairs. If the active channel occupies more than the max spreading factor (15 ksps) the power is duplicated (active symbol rate / 15 ksps) times.</p> <p>1st number = 1st in-phase code power over the slot 2nd number = 1st quad-phase code power over the slot ... (2\timesN-1) number = Nth in-phase code power over the slot (2 \times N) number = Nth quad-phase code power over a slot</p> <p>N = the number of codes detected. The total number of codes varies because of the different symbol rates of each code.</p>
<p>8 1xEV-DO mode</p>	<p>The same as n=4. (Overall-1)</p> <p>This trace is available when the Measurement Channel Type Selection is All (CALCulate:RHO:TYPE = ALL)</p> <p>(Rho Overall-1 and Rho Overall-2 as specified in 3GPP2 TSG-C4.1 Recommended Minimum Performance Standard for cdma2000 High Rate Data Packet Access Network, 11.4.2 Waveform Quality Measurement section.)</p> <p>n=6, 7, 8, 9 are for Overall-1 data trace n=10, 11, 12, 13 are for Overall-2 data trace</p> <p>In all cases, returns one full slot data points, but only portion of EVM computation is performed are valid. All other portion is 0.0</p>
<p>9 W-CDMA mode</p>	<p>Slot RMS EVM:</p> <p>Slot RMS EVM trace returns series of floating point numbers (in percent) that represent each slot RMS EVM trace of Capture Interval. The first number is of the first slot in Capture Interval. Total length of trace is equivalent to Capture Interval in slot.</p>

n	Results Returned
<p>9 1xEV-DO mode</p>	<p>The same as n=5. (Overall-1)</p> <p>This trace is available when the Measurement Channel Type Selection is All (CALCulate:RHO:TYPE = ALL)</p> <p>(Rho Overall-1 and Rho Overall-2 as specified in 3GPP2 TSG-C4.1 Recommended Minimum Performance Standard for cdma2000 High Rate Data Packet Access Network, 11.4.2 Waveform Quality Measurement section.)</p> <p>n=6, 7, 8, 9 are for Overall-1 data trace n=10, 11, 12, 13 are for Overall-2 data trace</p> <p>In all cases, returns one full slot data points, but only portion of EVM computation is performed are valid. All other portion is 0.0</p>
<p>10 W-CDMA mode</p>	<p>Peak CDE:</p> <p>Peak CDE trace of Capture Interval, returns series of floating point numbers that represent the Peak CDE as following:</p> <p>1st number = Peak CDE Symbol Rate of 1st slot in Capture Interval 2nd number = Peak CDE Code Index of 1st slot in Capture Interval 3rd number = I/Q Phase of Peak CDE I-Phase = 1.0 (for MS) Q-Phase = 1.0 (for MS) IQ = 999.0 (for BTS) 4th number = Peak CDE Value of 1st slot in Capture Interval</p> <p>...</p> <p>(4Y(N-1)+1) th number = Peak CDE Symbol Rate of Nth slot in Capture Interval. (4Y(N-1)+2) th number = Peak CDE Code Index of Nth slot in Capture Interval. (4Y(N-1)+3) th number = I/Q Phase of Peak CDE I-Phase = 1.0 (for MS) Q-Phase = 1.0 (for MS) IQ = 999.0 (for BTS) (4YN) th Number = Peak CDE value of Nth slot in Capture Interval.</p> <p>where N is Capture Interval in slot, and the length of the trace is 4YN.</p>

n	Results Returned
<p>10 1xEV-DO mode</p>	<p>The same as n=2. (Overall-2)</p> <p>This trace is available when the Measurement Channel Type Selection is All (CALCulate:RHO:TYPE = ALL)</p> <p>(Rho Overall-1 and Rho Overall-2 as specified in 3GPP2 TSG-C4.1 Recommended Minimum Performance Standard for cdma2000 High Rate Data Packet Access Network, 11.4.2 Waveform Quality Measurement section.)</p> <p>n=6, 7, 8, 9 are for Overall-1 data trace n=10, 11, 12, 13 are for Overall-2 data trace</p> <p>In all cases, returns one full slot data points, but only portion of EVM computation is performed are valid. All other portion is 0.0</p>
<p>11 cdmaOne mode</p>	<p>Corrected measured data – returns a series of floating point numbers that alternately represent I and Q pairs of the corrected measured trace data. The magnitude of each I and Q pair are normalized to 1.0.</p> <p>The number of trace points depends on the current setting for the number of displayed I/Q points in the I/Q display.</p> <p>The numbers are sent in the following order:</p> <p style="padding-left: 40px;">In-phase (I) sample, of symbol 0 decision point Quadrature-phase (Q) sample, of symbol 0 decision point ... In-phase (I) sample, of symbol 1 decision point Quadrature-phase (Q) sample, of symbol 1 decision point ...</p> <p>The trace can be interpolated to 2,4,8 points/chip selected with the display Points/Chip softkey. This will change the number of points between decision points in the trace, changing the number of I/Q pairs sent for each decision point.</p>
<p>11 W-CDMA mode</p>	<p>Slot Frequency Error:</p> <p>Slot Frequency Error trace returns series of floating point numbers (in Hz) that represents each slot frequency error. Total length of trace is Capture Interval in slot.</p>

n	Results Returned
<p>11 1xEV-DO mode</p>	<p>The same as n=2. (Overall-2)</p> <p>This trace is available when the Measurement Channel Type Selection is All (CALCulate:RHO:TYPE = ALL)</p> <p>(Rho Overall-1 and Rho Overall-2 as specified in 3GPP2 TSG-C4.1 Recommended Minimum Performance Standard for cdma2000 High Rate Data Packet Access Network, 11.4.2 Waveform Quality Measurement section.)</p> <p>n=6, 7, 8, 9 are for Overall-1 data trace n=10, 11, 12, 13 are for Overall-2 data trace</p> <p>In all cases, returns one full slot data points, but only portion of EVM computation is performed are valid. All other portion is 0.0</p>
<p>12 W-CDMA mode</p>	<p>Slot CPICH Power:</p> <p>In BTS mode, Slot CPICH Power trace returns the series of floating point numbers (in dB) of the code domain power of CPICH.</p> <p>In MS mode, dummy data (=–999.0) is returned.</p> <p>Total length of trace is Capture Interval in slot.</p>
<p>12 1xEV-DO mode</p>	<p>The same as n=4. (Overall-2)</p> <p>This trace is available when the Measurement Channel Type Selection is All (CALCulate:RHO:TYPE = ALL)</p> <p>(Rho Overall-1 and Rho Overall-2 as specified in 3GPP2 TSG-C4.1 Recommended Minimum Performance Standard for cdma2000 High Rate Data Packet Access Network, 11.4.2 Waveform Quality Measurement section.)</p> <p>n=6, 7, 8, 9 are for Overall-1 data trace n=10, 11, 12, 13 are for Overall-2 data trace</p> <p>In all cases, returns one full slot data points, but only portion of EVM computation is performed are valid. All other portion is 0.0</p>

n	Results Returned
13 cdmaOne mode	<p>complementary filtered measured data – returns a series of floating point numbers that alternately represent I and Q pairs of the complementary filtered measured data. This is inverse filtered data of the inter-symbol interference in CDMA signals due to the digital transmission filters defined in the standard as well as the base station phase equalization filter.</p> <p>The number of trace points depends on the current setting for the number of displayed I/Q points in the I/Q display.</p> <p>The numbers are sent in the following order:</p> <p style="padding-left: 40px;">In-phase (I) sample, of symbol 0 decision point Quadrature-phase (Q) sample, of symbol 0 decision point ... In-phase (I) sample, of symbol 1 decision point Quadrature-phase (Q) sample, of symbol 1 decision point ...</p> <p>The trace can be interpolated to 2,4,8 points/chip selected with the display Points/Chip softkey. This will change the number of points between decision points in the trace, changing the number of I/Q pairs sent for each decision point.</p>
13 W-CDMA mode	<p>Slot Average Total Power:</p> <p>Slot Average Total Power trace returns the series of floating point numbers (in dBm) of the total power. Total length of trace is Capture Interval in slot.</p>
13 1xEV-DO mode	<p>The same as n=5. (Overall-2)</p> <p>This trace is available when the Measurement Channel Type Selection is All (CALCulate:RHO:TYPE = ALL)</p> <p>(Rho Overall-1 and Rho Overall-2 as specified in 3GPP2 TSG-C4.1 Recommended Minimum Performance Standard for cdma2000 High Rate Data Packet Access Network, 11.4.2 Waveform Quality Measurement section.)</p> <p>n=6, 7, 8, 9 are for Overall-1 data trace n=10, 11, 12, 13 are for Overall-2 data trace</p> <p>In all cases, returns one full slot data points, but only portion of EVM computation is performed are valid. All other portion is 0.0</p>

n	Results Returned
<p>14 W-CDMA mode</p>	<p>Average Results: Average scalar results trace returns 13 comma-separated scalar results:</p> <ol style="list-style-type: none"> 1. RMS EVM is a floating point number (in percent) of EVM over the entire measurement area 2. Peak EVM is a floating point number (in percent) of peak EVM in the measurement area 3. Magnitude error is a floating point number (in percent) of average magnitude error over the entire measurement area 4. Phase error is a floating point number (in degree) holding the result with absolute maximum value of average phase error over the entire measurement area 5. I/Q origin offset is a floating point number (in dB) of the I and Q error (magnitude squared) offset from the origin 6. Frequency error is a floating point number (in Hz) holding the result with absolute maximum value of the frequency error in the measured signal 7. Rho is a floating point number holding the minimum result of Rho 8. Peak Code Domain Error is a floating point number (in dB) of the Peak Code Domain Error relative to the mean power 9. Peak Code Domain Error Channel Number is the channel number in which the peak code domain error is detected at the max spreading factor. 10. Number of active channels 11. Time offset is a floating points number (in chip) of the pilot phase timing from the acquisition trigger point. 12. CPICH power over a slot is a floatings point number in dB of CPICH power over a measurement slot. In the MS mode the value returned is -999. 13. Total power over a slot is a floating points number in dBm of total RF power over a measurement slot.

n	Results Returned
<p>14 1xEV-DO mode</p>	<p>The same as n=5. (Overall-2) I/Q trace data is descrambled.</p> <p>This trace is available when the Measurement Channel Type Selection is All (CALCulate:RHO:TYPE = ALL)</p> <p>(Rho Overall-1 and Rho Overall-2 as specified in 3GPP2 TSG-C4.1 Recommended Minimum Performance Standard for cdma2000 High Rate Data Packet Access Network, 11.4.2 Waveform Quality Measurement section.)</p> <p>n=6, 7, 8, 9 are for Overall-1 data trace n=10, 11, 12, 13 are for Overall-2 data trace</p> <p>In all cases, returns one full slot data points, but only portion of EVM computation is performed are valid. All other portion is 0.0</p>

n	Results Returned
<p>15 W-CDMA mode</p>	<p>Peak Hold Results: Peak Hold scalar results trace returns 13 comma-separated scalar results:</p> <ol style="list-style-type: none"> 1. RMS EVM is a floating point number (in percent) of EVM over the entire measurement area 2. Peak EVM is a floating point number (in percent) of peak EVM in the measurement area 3. Magnitude error is a floating point number (in percent) of average magnitude error over the entire measurement area 4. Phase error is a floating point number (in degree) holding the result with absolute maximum value of average phase error over the entire measurement area 5. I/Q origin offset is a floating point number (in dB) of the I and Q error (magnitude squared) offset from the origin 6. Frequency error is a floating point number (in Hz) holding the result with absolute maximum value of the frequency error in the measured signal 7. Rho is a floating point number holding the minimum result of Rho 8. Peak Code Domain Error is a floating point number (in dB) of the Peak Code Domain Error relative to the mean power 9. Peak Code Domain Error Channel Number is the channel number in which the peak code domain error is detected at the max spreading factor. 10. Number of active channels 11. Time offset is a floating points number (in chip) of the pilot phase timing from the acquisition trigger point. 12. CPICH power over a slot is a floatings point number in dB of CPICH power over a measurement slot. In the MS mode the value returned is -999. 13. Total power over a slot is a floating points number in dBm of total RF power over a measurement slot.

n	Results Returned
<p>15 1xEV-DO mode</p>	<p>Returns comma-separated scalar values of the pass/fail (0.0=passed, or 1.0=failed) results determined by testing the EVM, Peak EVM:</p> <ol style="list-style-type: none"> 1. Test result of EVM 2. Test result of Peak EVM 3. Test result of Rho 4. Test result of Frequency Error <p>The following Timing and Phase results are valid only if Multichannel Estimator is On and with the existence of multiple codes. When the measurement is not valid, the results are 0.0</p> <ol style="list-style-type: none"> 5. Test result of Timing 6. Test result of Phase <p>The following Pilot Offset result is valid only if external trigger is selected. When the measurement is not valid, the result is 0.0</p> <ol style="list-style-type: none"> 7. Test result of Pilot Offset <p>The following three results are valid exclusively. When the measurement is not valid, the result is 0.0</p> <ol style="list-style-type: none"> 8. Test result of Max MAC Inactive Channel Power 9. Test result of Max Data Active Channel Power 10. Test result of Min Data Active Channel Power

Spurious Emissions Measurement

This measures spurious emissions levels up to five pairs of offset/region frequencies and relates them to the carrier power. You must be in the cdma2000, W-CDMA or 1xEV-DO mode to use these commands. Use INSTRument:SElect to set the mode. For 1xEV-DO mode, this command will return spurious emissions measurements or adjacent channel power measurements, depending on which setting is selected using SENSE:SEMask:SEGment:TYPE ACPr|SEMask.

The general functionality of CONFigure, FETCh, MEASure, and READ are described at the beginning of this section. See the SENSE:SEMask commands for more measurement related commands.

```
:CONFigure:SEMask  
:INITiate:SEMask  
:FETCh:SEMask [n] ?  
:READ:SEMask [n] ?  
:MEASure:SEMask [n] ?
```

Key Path: **Measure, Spectrum Emission Mask**

After the measurement is selected, press **Restore Meas Defaults** to restore factory defaults.

Measurement Results Available

Measurement Type	n	Results Returned
	0	Returns unprocessed I/Q trace data, as a series of trace point values, in volts.

Measurement Type	n	Results Returned
Total power reference	n=1 (or not specified)	<p>Returns 60 scalar results, in the following order:</p> <ol style="list-style-type: none"> 1. Reserved for future use, returns -999.0 2. Absolute power at the center frequency (reference) area (dBm) 3. Reserved for future use, returns -999.0 4. Reserved for future use, returns -999.0 5. Peak frequency in the center frequency (reference) area (Hz) 6. Reserved for future use, returns -999.0 7. Reserved for future use, returns -999.0 8. Reserved for future use, returns -999.0 9. Reserved for future use, returns -999.0 10. Reserved for future use, returns -999.0 11. Relative power on the negative offset A (dBc) 12. Absolute power on the negative offset A (dBm) 13. Relative peak power on the negative offset A (dBc) 14. Absolute peak power on the negative offset A (dBm) 15. Peak frequency in the negative offset A (Hz) 16. Relative power on the positive offset A (dBc) 17. Absolute power on the positive offset A (dBm) 18. Relative peak power on the positive offset A (dBc) 19. Absolute peak power on the positive offset A (dBm) 20. Peak frequency in the positive offset A (Hz) 21. Relative power on the negative offset B (dBc) <p style="text-align: center;">. . .</p> <ol style="list-style-type: none"> 1. Absolute peak power on the positive offset E (dBm) 2. Peak frequency in the positive offset E (Hz) <p>When [:SENSe]:SEMask:SEGMENT is set to REGION, the positive offsets are not available and return -999.0.</p>

Measurement Type	n	Results Returned
Power spectral density reference	n=1 (or not specified)	<p>Returns 60 scalar results, in the following order:</p> <ol style="list-style-type: none"> 1. Reserved for future use, returns -999.0 2. Absolute power at the center frequency (reference) area (dBm) 3. Reserved for future use, returns -999.0 4. Reserved for future use, returns -999.0 5. Peak frequency in the center frequency (reference) area (Hz) 6. Reserved for future use, returns -999.0 7. Reserved for future use, returns -999.0 8. Reserved for future use, returns -999.0 9. Reserved for future use, returns -999.0 10. Reserved for future use, returns -999.0 11. Relative power on the negative offset A (dB) 12. Absolute power on the negative offset A (dBm/Hz) 13. Relative peak power on the negative offset A (dB) 14. Absolute peak power on the negative offset A (dBm/Hz) 15. Peak frequency in the negative offset A (Hz) 16. Relative power on the positive offset A (dB) 17. Absolute power on the positive offset A (dBm/Hz) 18. Relative peak power on the positive offset A (dB) 19. Absolute peak power on the positive offset A (dBm/Hz) 20. Peak frequency in the positive offset A (Hz) 21. Relative power on the negative offset B (dB) <p style="text-align: center;">. . .</p> <ol style="list-style-type: none"> 1. Absolute peak power on the positive offset E (dBm/Hz) 2. Peak frequency in the positive offset E (Hz) <p>When [:SENSe]:SEMask:SEGMENT is set to REGION, the positive offsets are not available and return -999.0.</p>
	2	Returns the displayed frequency domain spectrum trace data separated by comma. The number of data is 2001 when DISPLAY:SEMask:VIEW is set to ALL.
	3	Returns the displayed frequency domain absolute limit trace data separated by comma. The number of data is 2001 when DISPLAY:SEMask:VIEW is set to ALL.
	4	Returns the displayed frequency domain relative limit trace data separated by comma. The number of data is 2001 when DISPLAY:SEMask:VIEW is set to ALL.

Measurement Type	n	Results Returned
Total power reference	5	<p>Returns 12 scalar values (in dBm) of the absolute power of the segment frequencies:</p> <ol style="list-style-type: none"> 1. Total power reference (dBm), for cdma2000 and W-CDMA Reserved for future use, returns -999.0, for 1xEV-DO 2. Reserved for future use, returns -999.0 3. Negative offset frequency (A) or region (A) 4. Positive offset frequency (A) <p style="text-align: center;">. . .</p> <ol style="list-style-type: none"> 1. Negative offset frequency (E) or region (E) 2. Positive offset frequency (E) <p>When [:SENSE]:SEMAsk:SEGMENT is set to REGION, the positive offsets are not available and return -999.0.</p>
Power spectral density reference	5	<p>Returns 12 scalar values (in dBm/Hz) of the absolute power of the segment frequencies:</p> <ol style="list-style-type: none"> 1. Power spectral density reference (dBm/Hz), for cdma2000 and W-CDMA Reserved for future use, returns -999.0, for 1xEV-DO 2. Reserved for future use, returns -999.0 3. Negative offset frequency (A) or region (A) 4. Positive offset frequency (A) <p style="text-align: center;">. . .</p> <ol style="list-style-type: none"> 1. Negative offset frequency (E) or region (E) 2. Positive offset frequency (E) <p>When [:SENSE]:SEMAsk:SEGMENT is set to REGION, the positive offsets are not available and return -999.0.</p>
Total power reference	6	<p>Returns 12 scalar values (in dBc) of the power relative to the carrier at the segment frequencies:</p> <ol style="list-style-type: none"> 1. Reserved for future use, returns -999.0 2. Reserved for future use, returns -999.0 3. Negative offset frequency (A) or region (A) 4. Positive offset frequency (A) <p style="text-align: center;">. . .</p> <ol style="list-style-type: none"> 1. Negative offset frequency (E) or region (E) 2. Positive offset frequency (E) <p>When [:SENSE]:SEMAsk:SEGMENT is set to REGION, the positive offsets are not available and return -999.0.</p>

Measurement Type	n	Results Returned
Power spectral density reference	6	<p>Returns 12 scalar values (in dBc) of the power relative to the carrier at the segment frequencies:</p> <ol style="list-style-type: none"> 1. Reserved for future use, returns -999.0 2. Reserved for future use, returns -999.0 3. Negative offset frequency (A) or region (A) 4. Positive offset frequency (A) <p style="text-align: center;">. . .</p> <ol style="list-style-type: none"> 1. Negative offset frequency (E) or region (E) 2. Positive offset frequency (E) <p>When [:SENSE]:SEMask:SEGMENT is set to REGION, the positive offsets are not available and return -999.0.</p>
	7	<p>Returns 12 pass/fail test results (0 = passed, or 1 = failed) determined by testing the absolute power of the segment frequencies:</p> <ol style="list-style-type: none"> 1. Reserved for future use, returns -999.0 2. Reserved for future use, returns -999.0 3. Negative offset frequency (A) or region (A) 4. Positive offset frequency (A) <p style="text-align: center;">. . .</p> <ol style="list-style-type: none"> 1. Negative offset frequency (E) or region (E) 2. Positive offset frequency (E) <p>When [:SENSE]:SEMask:SEGMENT is set to REGION, the positive offsets are not available and return -999.0.</p>
	8	<p>Returns 12 scalar values of the pass/fail (0=passed, or 1=failed) results determined by testing the power relative to the segment frequencies:</p> <ol style="list-style-type: none"> 1. Reserved for future use, returns -999.0 2. Reserved for future use, returns -999.0 3. Negative offset frequency (A) or region (A) 4. Positive offset frequency (A) <p style="text-align: center;">. . .</p> <ol style="list-style-type: none"> 1. Negative offset frequency (E) or region (E) 2. Positive offset frequency (E) <p>When [:SENSE]:SEMask:SEGMENT is set to REGION, the positive offsets are not available and return -999.0.</p>

Measurement Type	n	Results Returned
	9	<p>Returns 12 scalar values of frequency (in Hz) that have peak power in each offset/region:</p> <ol style="list-style-type: none"> 1. Reserved for future use, returns –999.0 2. Reserved for future use, returns –999.0 3. Negative offset frequency (A) or region (A) 4. Positive offset frequency (A) <p style="text-align: center;">. . .</p> <ol style="list-style-type: none"> 1. Negative offset frequency (E) or region (E) 2. Positive offset frequency (E) <p>When [:SENSE]:SEMAsk:SEGMENT is set to REGION, the positive offsets are not available and return –999.0.</p>
	10	<p>Returns 12 scalar values (in dBm) of the absolute peak power of the segment frequencies:</p> <ol style="list-style-type: none"> 1. Reserved for future use, returns –999.0 2. Reserved for future use, returns –999.0 3. Negative offset frequency (A) or region (A) 4. Positive offset frequency (A) <p style="text-align: center;">. . .</p> <ol style="list-style-type: none"> 1. Negative offset frequency (E) or region (E) 2. Positive offset frequency (E) <p>When [:SENSE]:SEMAsk:SEGMENT is set to REGION, the positive offsets are not available and return –999.0.</p>
	11	<p>Returns 12 scalar values (in dBc) of the peak power relative to the carrier at the segment frequencies:</p> <ol style="list-style-type: none"> 1. Reserved for future use, returns –999.0 2. Reserved for future use, returns –999.0 3. Negative offset frequency (A) or region (A) 4. Positive offset frequency (A) <p style="text-align: center;">. . .</p> <ol style="list-style-type: none"> 1. Negative offset frequency (E) or region (E) 2. Positive offset frequency (E) <p>When [:SENSE]:SEMAsk:SEGMENT is set to REGION, the positive offsets are not available and return –999.0.</p>

Spectrum (Frequency Domain) Measurement

For E4406A this measures the amplitude of your input signal with respect to the frequency. It provides spectrum analysis capability using FFT (fast Fourier transform) measurement techniques. You must select the appropriate mode using INSTRument:SElect, to use these commands.

For PSA this measures the amplitude of your input signal with respect to the frequency. It provides spectrum analysis capability using FFT (fast Fourier transform) measurement techniques. You must be in the Basic, cdmaOne, cdma2000, 1xEV-DO, W-CDMA, GSM (w/EDGE), NADC, or PDC mode to use these commands. Use INSTRument:SElect, to select the mode.

The general functionality of CONFigure, FETCh, MEASure, and READ are described at the beginning of this section. See the SENSE:SPECTrum commands for more measurement related commands.

```
:CONFigure:SPECTrum  
:INITiate:SPECTrum  
:FETCh:SPECTrum [n] ?  
:READ:SPECTrum [n] ?  
:MEASure:SPECTrum [n] ?
```

Key Path: **Measure, Spectrum (Freq Domain)**

After the measurement is selected, press **Restore Meas Defaults** to restore factory defaults.

Measurement Results Available

n	Results Returned
0	Returns unprocessed I/Q trace data, as a series of trace point values, in volts. The I values are listed first in each pair, using the 0 through even-indexed values. The Q values are the odd-indexed values.

n	Results Returned
n=1 (or not specified)	<p>Returns the following scalar results:</p> <ol style="list-style-type: none"> 1. FFT peak is the FFT peak amplitude. 2. FFT frequency is the FFT frequency of the peak amplitude. 3. FFT points is the Number of points in the FFT spectrum. 4. First FFT frequency is the frequency of the first FFT point of the spectrum. 5. FFT spacing is the frequency spacing between the FFT points of the spectrum. 6. Time domain points is the number of points in the time domain trace used for the FFT. The number of points doubles if the data is complex instead of real. See the time domain scaler description below. 7. First time point is the time of the first time domain point, where time zero is the trigger event. 8. Time spacing is the time spacing between the time domain points. The time spacing value doubles if the data is complex instead of real. See the time domain scaler description below. 9. Time domain returns a 1 if time domain is complex (I/Q) and complex data will be returned. It returns a 0 if the data is real. (raw ADC samples) When this value is 1 rather than 0 (complex vs. real data), the time domain points and the time spacing scalers both increase by a factor of two. 10. Scan time is the total scan time of the time domain trace used for the FFT. The total scan time = (time spacing) X (time domain points – 1) 11. Current average count is the current number of data measurements that have already been combined, in the averaging calculation.
2, Service mode only	Returns the trace data of the log-magnitude versus time. (That is, the RF envelope.)
3	Returns the I and Q trace data. It is represented by I and Q pairs (in volts) versus time.
4	Returns spectrum trace data. That is, the trace of log-magnitude versus frequency. (The trace is computed using a FFT.)
5, Service mode only	Returns the averaged trace data of log-magnitude versus time. (That is, the RF envelope.)
6	Not used.
7	Returns the averaged spectrum trace data. That is, the trace of the averaged log-magnitude versus frequency.
8	Not used.
9, Service mode only	Returns a trace containing the shape of the FFT window.

n	Results Returned
10, Service mode only	Returns trace data of the phase of the FFT versus frequency.
11, cdma2000, 1xEV-DO, W-CDMA, Basic modes only	Returns linear spectrum trace data values in Volts RMS.
12, cdma2000, 1xEV-DO, W-CDMA, Basic modes only	Returns averaged linear spectrum trace data values in Volts RMS.

Timebase Frequency Measurement

The general functionality of **CONFigure**, **FETCh**, **MEASure**, and **READ** are described at the beginning of this section. See the **SENSe:TBFRequency** commands for more measurement related commands.

You must be in the Service mode to use these commands. Use **INSTrument:SElect** to set the mode.

```
:CONFigure:TBFRequency
:INITiate:TBFRequency
:FETCh:TBFRequency [n] ?
:READ:TBFRequency [n] ?
:MEASure:TBFRequency [n] ?
```

Remarks: For auto adjustment of the internal frequency reference (10 MHz timebase), use the **CALibration:FREQuency:REFerence:AADJust** command after this measurement has been selected.

Key Path: **Measure, Timebase Freq**
 After the measurement is selected, press **Restore Meas Defaults** to restore factory defaults.

Measurement Results Available

n	Results Returned
0	Not valid
n=1 (or not specified)	Returns scalar results: 1. RF input average amplitude 2. Average frequency error 3. Adjustment in process (returns 1 if an adjustment is being performed, returns 0 if no adjustment is in process)
2	Frequency error stripchart trace data.

Waveform (Time Domain) Measurement

For E4406A this measures the amplitude of your input signal with respect to the frequency. It provides spectrum analysis capability using FFT (fast Fourier transform) measurement techniques. You must select the appropriate mode using INSTRUMENT:SELEct, to use these commands.

For PSA this measures the amplitude of your input signal with respect to the frequency. It provides spectrum analysis capability using FFT (fast Fourier transform) measurement techniques. You must be in the Basic, cdmaOne, cdma2000, 1xEV-DO, W-CDMA, GSM (w/EDGE), NADC, or PDC mode to use these commands. Use INSTRUMENT:SELEct, to select the mode.

The general functionality of CONFigure, FETCh, MEASure, and READ are described at the beginning of this section. See the SENSE:WAVEform commands for more measurement related commands.

- :CONFigure:WAVEform**
- :INITiate:WAVEform**
- :FETCh:WAVEform [n] ?**
- :READ:WAVEform [n] ?**
- :MEASure:WAVEform [n] ?**

Key Path: **Measure, Waveform (Time Domain)**

After the measurement is selected, press **Restore Meas Defaults** to restore factory defaults.

Measurement Results Available

n	Results Returned
0 (see also 5)	Returns unprocessed I/Q trace data, as a series of trace point values, in volts. The I values are listed first in each pair, using the 0 through even-indexed values. The Q values are the odd-indexed values.
n=1 (or not specified)	<p>Returns the following scalar results:</p> <ol style="list-style-type: none"> 1. Sample time is a floating point number representing the time between samples when using the trace queries (n=0,2,etc). 2. Mean power is the mean power (in dBm). This is either the power across the entire trace, or the power between markers if the markers are enabled. If averaging is on, the power is for the latest acquisition. 3. Mean power averaged is the power (in dBm) for N averages, if averaging is on. This is either the power across the entire trace, or the power between markers if the markers are enabled. If averaging is on, the power is for the latest acquisition. If averaging is off, the value of the mean power averaged is the same as the value of the mean power. 4. Number of samples is the number of data points in the captured signal. This number is useful when performing a query on the signal (i.e. when n=0,2,etc.). 5. Peak-to-mean ratio has units of dB. This is the ratio of the maximum signal level to the mean power. Valid values are only obtained with averaging turned off. If averaging is on, the peak-to-mean ratio is calculated using the highest peak value, rather than the displayed average peak value. 6. Maximum value is the maximum of the most recently acquired data (in dBm). 7. Minimum value is the minimum of the most recently acquired data (in dBm).
2	Returns trace point values of the entire captured signal envelope trace data. These data points are floating point numbers representing the power of the signal (in dBm). There are N data points, where N is the number of samples . The period between the samples is defined by the sample time .
3, Option B7C with cdma2000, W-CDMA, Basic modes only (E4406A only)	Returns magnitude values of the time data in Volts peak.
4, Option B7C with cdma2000, W-CDMA, Basic modes only (E4406A only)	Returns values of phase data in degrees.

READ Subsystem

The READ? commands are used with several other commands and are documented in the section on the [“MEASure Group of Commands” on page 654](#).

Initiate and Read Measurement Data

:READ:<measurement> [n] ?

A READ? query must specify the desired measurement. It will cause a measurement to occur without changing any of the current settings and will return any valid results. The code number n selects the kind of results that will be returned. The available measurements and data results are described in the [“MEASure Group of Commands” on page 654](#).

SENSe Subsystem

These commands are used to set the instrument state parameters so that you can measure a particular input signal. Some SENSe commands are only for use with specific measurements found under the MEASURE key menu or the “MEASure Group of Commands” on page 654. The measurement must be active before you can use these commands.

The SCPI default for the format of any data output is ASCII. The format can be changed to binary with FORMat:DATA which transports faster over the bus.

Adjacent Channel Power Measurement

Commands for querying the adjacent channel power measurement results and for setting to the default values are found in the “MEASure Group of Commands” on page 654. The equivalent front-panel keys for the parameters described in the following commands, are found under the **Meas Setup** key, after the **ACP** or **ACPR** measurement has been selected from the **MEASURE** key menu.

Adjacent Channel Power—Average Count

```
[ :SENSe ] :ACP :AVERAge :COUNT <integer>
```

```
[ :SENSe ] :ACP :AVERAge :COUNT?
```

Set the number of data acquisitions that will be platform averaged. After the specified number of average counts, the average mode (termination control) setting determines the average action.

Factory Preset: 10 for cdma2000, W-CDMA

20 for Basic, cdmaOne, iDEN (E4406A)

Range: 1 to 10,000

Remarks: Use INSTRument:SElect to set the mode.

Key Path: **Meas Setup**

Adjacent Channel Power—Averaging State

```
[ :SENSe ] :ACP:AVERAge [ :STATe ] OFF | ON | 0 | 1
```

```
[ :SENSe ] :ACP:AVERAge [ :STATe ] ?
```

Turn the averaging function On or Off.

Factory Preset: On

Off for iDEN mode (E4406A)

Remarks: Use INSTRument:SElect to set the mode.

Key Path: **Meas Setup**

Adjacent Channel Power—Averaging Termination Control

```
[ :SENSe ] :ACP:AVERAge:TCONtrol EXPOnential | REPEAT
```

```
[ :SENSe ] :ACP:AVERAge:TCONtrol ?
```

Select the type of termination control used for averaging. This determines the averaging action after the specified number of data acquisitions (average count) is reached.

EXPOnential – Each successive data acquisition after the average count is reached, is exponentially weighted and combined with the existing average.

REPEAT – After reaching the average count, the averaging is reset and a new average is started.

Factory Preset: REPEAT for PSA cdmaOne, cdma2000, W-CDMA

REPEAT for E4406A Basic, cdmaOne, cdma2000,
W-CDMA

EXPOnential for E4406A iDEN

EXPOnential for NADC, PDC

Remarks: Use INSTRument:SElect to set the mode.

Adjacent Channel Power—Carrier Channel Integration BW

Basic, iDEN, WiDEN mode (E4406A)

[:SENSe] :ACP:BA^NDwidth | BWIDth:INTEgration <freq>

[:SENSe] :ACP:BA^NDwidth | BWIDth:INTEgration?

cdma2000, W-CDMA mode

[:SENSe] :ACP:BA^NDwidth [n] | BWIDth [n] :INTEgration <freq>

[:SENSe] :ACP:BA^NDwidth [n] | BWIDth [n] :INTEgration?

cdmaOne mode

[:SENSe] :ACP:BA^NDwidth [n] | BWIDth [n] :INTEgration [m] <freq>

[:SENSe] :ACP:BA^NDwidth [n] | BWIDth [n] :INTEgration [m] ?

Set the Integration bandwidth that will be used for the main (carrier) channel.

BANDwidth[n] |

BWIDth[n]: m=1 is base station and 2 is mobile. The default is base station (1).

INTEgration[m]: m=1 is cellular bands and 2 is pcs bands. The default is cellular.

Example: *WiDEN mode (E4406A)*

ACP:BA^ND:INT 93 kHz

Factory Preset:

Mode	Format (Modulation Standard)		
Basic (E4406A)	1.23 MHz		
cdmaOne	1.23 MHz		
iDEN (E4406A)	18 kHz		
cdma2000	1.23 MHz		
W-CDMA	3.84 MHz		

Factory Preset: *WiDEN mode (E4406A)*

Carrier Configuration Setting	Default
Auto	Actual value depends on detected carrier configuration and cannot be changed.
25 kHz	18.0 kHz
50 kHz	43.0 kHz
50 kHz outer	93.0 kHz
75 kHz	68.0 kHz
100 kHz	93.0 kHz

Range: 300 Hz to 20 MHz for Basic (E4406A), cdmaOne, cdma2000, or W-CDMA mode

1 kHz to 5 MHz for iDEN, WiDEN (E4406A)

Default Unit: Hz

Remarks: With measurement type set at (TPR) total power reference, 1.40 MHz is sometimes used. Using 1.23 MHz will give a power that is very nearly identical to the 1.40 MHz value, and using 1.23 MHz will also yield the correct power spectral density with measurement type set at (PSD) reference. However, a setting of 1.40 MHz will not give the correct results with measurement type set at PSD reference.

For PSA you must be in cdmaOne, cdma2000, or W-CDMA mode to use this command. Use INSTRument:SElect to set the mode.

For WiDEN: if you have set the Carrier Config (RADio:CARRier[:TYPE]) to AUTO, the value is set to the default value described in “Factory Preset:” above according to the actual carrier config (you can see it by casting RADio:CARRier[:TYPE]:ACTual?) You can not change this value. Even if the you set this value using SCPI, it is ignored and the default value is used.

For E4406A you must be in Basic, cdmaOne, cdma2000, W-CDMA, iDEN, or WiDEN mode to use this command. Use INSTRument:SElect to set the mode.

Key Path: **Meas Setup**

Adjacent Channel Power—Fast Mode ADC Range

For E4406A w/ 12-bit ADC:

```
[ :SENSe ] :ACP:FAST:OFFSet:ADC:RANGe  
AUTO | APEak | APLock | M6 | P0 | P6 | P12 | P18 | P24
```

For PSA and E4406A w/ 14-bit ADC:

```
[ :SENSe ] :ACP:FAST:OFFSet:ADC:RANGe  
AUTO | APEak | APLock | NONE | P0 | P6 | P12 | P18
```

```
[ :SENSe ] :ACP:FAST:OFFSet:ADC:RANGe?
```

Select the range for the gain-ranging that is done in front of the ADC when the [:SENSe] :ACP:SWEep:TYPE is set to Fast. This is an advanced control that normally does not need to be changed. If you are measuring a CW signal, see the description below.

- Auto - sets the ADC range automatically. For most FFT measurements, the auto feature should not be selected. An exception is when measuring a signal which is “bursty,” in which case the auto feature can maximize the time domain dynamic range, if FFT results are less important to you than time domain results.
- Auto Peak (APEak) - sets the ADC range automatically to the peak signal level. The auto peak feature is a compromise that works well for both CW and burst signals.
- Auto Peak Lock (APLock) - holds the ADC range automatically at the peak signal level. The auto peak lock feature is more stable than the auto peak feature for CW signals, but should not be used for “bursty” signals.
- NONE - (14-bit ADC E4406A and PSA) turns off any auto-ranging without changing the current setting.
- M6 - (12-bit ADC E4406A) sets an ADC range that subtracts 6 dB of fixed gain across the range manually. Manual ranging is best for CW signals.
- P0, P6, P12, or P18 - (14-bit ADC E4406A and PSA) selects ADC ranges that add 0, 6, 12, or 18 dB of fixed gain across the range manually. Manual ranging is best for CW signals.
- P0, P6, P12, P18, or P24 - (12-bit ADC E4406A) selects ADC ranges that add 0, 6, 12, 18, or 24 dB of fixed gain across the range manually. Manual ranging is best for CW signals.

Factory Preset: Auto Peak (APEak)

Remarks: You must be in the W-CDMA mode to use this command. Use INSTRument:SElect to set the mode.

Adjacent Channel Power—Fast Mode Relative Attenuation

```
[ :SENSe ] :ACP:FAST:OFFSet:RATTenuation <rel power>
[ :SENSe ] :ACP:FAST:OFFSet:RATTenuation?
```

Sets a relative amount of attenuation for the measurements at the offset channels when the [:SENSe] :ACP:SWEep:TYPE is set to Fast. This attenuation is always specified relative to the attenuation that is required to measure the carrier channel. Since the offset channel power is lower than the carrier channel power, less attenuation is required to measure the offset channels and wider dynamic range for the measurement is available.

Factory Preset: 0

Range: -40.00 to 0.00 dB

Remarks: You must be in the W-CDMA mode to use this command. Use INSTRument:SElect to set the mode.

Adjacent Channel Power—Root Raised Cosine Filter Alpha

```
[ :SENSe ] :ACP:FILTer [ :RRC ] :ALPHa <numeric>
[ :SENSe ] :ACP:FILTer [ :RRC ] :ALPHa?
```

Set the alpha value of the Root Raised Cosine (RRC) filter.

Factory Preset: 0.22

Range: 0.01 to 0.5

Remarks: You must be in the W-CDMA mode to use this command. Use INSTRument:SElect to set the mode.

Adjacent Channel Power—Root Raised Cosine Filter Control

```
[ :SENSe ] :ACP:FILTer [ :RRC ] [ :STATe ] OFF|ON|0|1
[ :SENSe ] :ACP:FILTer [ :RRC ] [ :STATe ] ?
```

Turn the Root Raised Cosine (RRC) filter on or off.

Factory Preset: On

Remarks: You must be in the W-CDMA mode to use this command. Use INSTRument:SElect to set the mode.

Adjacent Channel Power—Absolute Amplitude Limits

iDEN mode (E4406A)

```
[ :SENSe ] :ACP:OFFSet:ABSolute <power>
```

```
[ :SENSe ] :ACP:OFFSet:ABSolute?
```

WiDEN mode (E4406A)

```
[ :SENSe ] :ACP:OFFSet:LIST:ABSolute <power>,<power>
```

```
[ :SENSe ] :ACP:OFFSet:LIST:ABSolute?
```

Basic (E4406A), cdmaOne mode

```
[ :SENSe ] :ACP:OFFSet:LIST:ABSolute  
<power>,<power>,<power>,<power>,<power>
```

```
[ :SENSe ] :ACP:OFFSet:LIST:ABSolute?
```

cdma2000, W-CDMA mode

```
[ :SENSe ] :ACP:OFFSet [n] :LIST:ABSolute  
<power>,<power>,<power>,<power>,<power>
```

```
[ :SENSe ] :ACP:OFFSet [n] :LIST:ABSolute?
```

Sets the absolute amplitude levels to test against for each of the custom offsets. The list must contain five (5) entries (two (2) entries for WiDEN). If there is more than one offset, the offset closest to the carrier channel is the first one in the list.

[:SENSe] :ACP:OFFSet [n] :LIST [m] :TEST selects the type of testing to be done at each offset.

You can turn off (not use) specific offsets with the [:SENSe] :ACP:OFFSet [n] :LIST:STATe command.

The query returns the five (5) sets of the real numbers that are the current absolute amplitude test limits.

Offset[n] n=1 is base station and 2 is mobiles. The default is base station (1).

List[m] m=1 is cellular bands and 2 is pcs bands. The default is cellular.

Factory Preset: *WiDEN mode (E4406A)*

Carrier Configuration Setting	Default	
	A	B
Auto	Actual value depends on detected carrier configuration and cannot be changed.	
25 kHz	0.0 dBm	N/A
50 kHz	0.0 dBm	N/A
50 kHz outer	0.0 dBm	0.0 dBm
75 kHz	0.0 dBm	N/A
100 kHz	0.0 dBm	N/A

Factory Preset:

Mode	Variant	Offset A	Offset B	Offset C	Offset D	Offset E
Basic (E4406A)		0 dBm	0 dBm	0 dBm	0 dBm	0 dBm
cdmaOne	BS cellular	0 dBm	0 dBm	0 dBm	0 dBm	0 dBm
	BS pcs	0 dBm	-13 dBm	-13 dBm	0 dBm	0 dBm
	MS cellular	0 dBm	0 dBm	0 dBm	0 dBm	0 dBm
	MS pcs	0 dBm	-13 dBm	-13 dBm	0 dBm	0 dBm
cdma2000		50 dBm	50 dBm	50 dBm	50 dBm	50 dBm
W-CDMA		50 dBm	50 dBm	50 dBm	50 dBm	50 dBm
iDEN (E4406A)		0 dBm	n/a	n/a	n/a	n/a

Range: -200.0 dBm to 50.0 dBm

Default Unit: dBm

- Remarks:
- For PSA you must be in cdmaOne, cdma2000, or W-CDMA mode to use this command. Use INSTRument:SElect to set the mode.
- For E4406A you must be in Basic, cdmaOne, cdma2000, W-CDMA, WiDEN, or iDEN mode to use this command. Use INSTRument:SElect to set the mode.
- For E4406A WiDEN mode:
- When you set these values remotely, the position of each value in the list sent corresponds to the offset. Missing values are not permitted. For example, if you want to change the value of offset “B”, you must send all values up to 2.
 - The default values are set according to [:SENSe]:RADio:CARRier[:TYPE]:ACTual? setting as defined in Defaults table shown above.
 - If you have set Carrier Config ([:SENSe]:RADio:CARRier[:TYPE]) to AUTO, the value is set to the default value described in “Factory Preset:” above according to the actual carrier configuration detected (you can see detected carrier configuration by sending [:SENSe]:RADio:CARRier[:TYPE]:ACTual?) You can not change this value. Even if the you set this value using SCPI, it is ignored and the default value is used.
 - You must always send two <freq> values regardless of the [:SENSe]:RADio:CARRier[:TYPE] setting. The first value is for offset “A” and the second is for offset “B”. Note that the offset “B” value is only used when [:SENSe]:RADio:CARRier[:TYPE]? returns O50, but two values are always needed when the you send this command. If you send only one value, “-109 Missing parameter” is returned.
 - When sending this query form of this command, the second element of the responded array is always present but only used when [:SENSe]:RADio:CARRier[:TYPE]:ACTual? returns O50.

Key Path: **Meas Setup, Ofs & Limits**

Adjacent Channel Power—Define Resolution Bandwidth List

iDEN mode (E4406A)

```
[ :SENSE ] :ACP:OFFSet: BANDwidth | BWIDth <res_bw>
```

```
[ :SENSE ] :ACP:OFFSet: BANDwidth | BWIDth?
```

WiDEN mode (E4406A)

```
[ :SENSE ] :ACP:OFFSet: BANDwidth | BWIDth <res_bw>, <res_bw>
```

```
[ :SENSE ] :ACP:OFFSet: BANDwidth | BWIDth?
```

Basic mode (E4406A)

```
[ :SENSE ] :ACP:OFFSet: LIST: BANDwidth | BWIDth  
<res_bw>, <res_bw>, <res_bw>, <res_bw>, <res_bw>
```

```
[ :SENSE ] :ACP:OFFSet: LIST: BANDwidth | BWIDth?
```

cdma2000, W-CDMA mode

```
[ :SENSE ] :ACP:OFFSet [n] : LIST: BANDwidth | BWIDth  
<res_bw>, <res_bw>, <res_bw>, <res_bw>, <res_bw>
```

```
[ :SENSE ] :ACP:OFFSet [n] : LIST: BANDwidth | BWIDth?
```

cdmaOne mode

```
[ :SENSE ] :ACP:OFFSet [n] : LIST [m] : BANDwidth | BWIDth  
<res_bw>, <res_bw>, <res_bw>, <res_bw>, <res_bw>
```

```
[ :SENSE ] :ACP:OFFSet [n] : LIST [m] : BANDwidth | BWIDth?
```

Define the custom resolution bandwidth(s) for the adjacent channel power testing. If there is more than one bandwidth, the list must contain five (5) entries. Each resolution bandwidth in the list corresponds to an offset frequency in the list defined by [:SENSE]:ACP:OFFSet[n]:LIST[m]:FREQUENCY]. You can turn off (not use) specific offsets with the [:SENSE]:ACP:OFFSet[n]:LIST[m]:STATE command.

Offset[n] n=1 is base station and 2 is mobiles. The default is base station (1).

List[m]

cdmaOne mode m=1 is cellular bands and 2 is pcs bands. The default is cellular.

cdma2000 mode m=1 is SR1, 2 is SR3 DS, and 3 is SR3 MC. The default is SR1 (1).

W-CDMA mode m=1 is ARIB, 2 is 3GPP, and 3 is Trial. The default is ARIB (1).

Example: *WiDEN mode (E4406A)*:

(Example #1) When [:SENSe]:RADio:CARRier [:TYPE]:ACTual? returns I25, I50, I75, or I100, and you want to set the offset bandwidth of offset A to 20 kHz, send: ACP:OFFS:LIST:band 20e3, 10e3 (the second value can be arbitrary, but it is needed).

(Example #2) When [:SENSe]:RADio:CARRier [:TYPE]:ACTual? returns O50, and you want to set the offset bandwidth of offset A and B to 20 kHz and 5 kHz respectively, send:
ACP:OFFS:LIST:band 20e3, 5e3

State Saved: Saved in Instrument State

Factory Preset: *WiDEN mode (E4406A)*

Carrier Configuration Setting	Default	
	A	B
Auto	Actual value depends on detected carrier configuration and cannot be changed.	
25 kHz	10.0 kHz	N/A
50 kHz	10.0 kHz	N/A
50 kHz outer	10.0 kHz	10.0 kHz
75 kHz	10.0 kHz	N/A
100 kHz	10.0 kHz	N/A

Factory Preset:

Mode	Variant	Offset A	Offset B	Offset C	Offset D	Offset E
iDEN (E4406A)		10 kHz	n/a	n/a	n/a	n/a
Basic (E4406A)		30 kHz	30 kHz	30 kHz	30 kHz	30 kHz
cdmaOne	BS cellular	30 kHz	30 kHz	30 kHz	30 kHz	30 kHz
	BS pcs	30 kHz	12.5 kHz	1 MHz	30 kHz	30 kHz
	MS cellular	30 kHz	30 kHz	30 kHz	30 kHz	30 kHz
	MS pcs	30 kHz	12.5 kHz	1 MHz	30 kHz	30 kHz
cdma2000		30 kHz	30 kHz	30 kHz	30 kHz	30 kHz
W-CDMA		3.84 MHz	3.84 MHz	3.84 MHz	3.84 MHz	3.84 MHz

Range: 300 Hz to 20 MHz for cdmaOne, Basic, cdma2000, W-CDMA mode

1 kHz to 5 MHz for iDEN mode (E4406A)

100 kHz to 20 MHz for WiDEN mode (E4406A)

Default Unit: Hz

Remarks: For PSA you must be in cdmaOne, cdma2000, or W-CDMA mode to use this command. Use INSTRument:SElect to set the mode.

For E4406A you must be in Basic, cdmaOne, cdma2000, W-CDMA, WiDEN, or iDEN mode to use this command. Use INSTRument:SElect to set the mode.

For E4406A WiDEN mode:

- When you set these values remotely, the position of each value in the list sent corresponds to the offset. Missing values are not permitted. For example, if you want to change the value of offset “B”, you must send all values up to 2.
- The default values are set according to [:SENSe]:RADIO:CARRier[:TYPE]:ACTual? setting as defined in Defaults table shown above.

- If you have set Carrier Config ([:SENSe]:RADio:CARRier[:TYPE]) to AUTO, the value is set to the default value described in “Factory Preset:” above according to the actual carrier configuration detected (you can see detected carrier configuration by sending [:SENSe]:RADio:CARRier[:TYPE]:ACTual?) You can not change this value. Even if the you set this value using SCPI, it is ignored and the default value is used.
- You must always send two <freq> values regardless of the [:SENSe]:RADio:CARRier[:TYPE] setting. The first value is for offset “A” and the second is for offset “B”. Note that the offset “B” value is only used when [:SENSe]:RADio:CARRier[:TYPE]? returns O50, but two values are always needed when the you send this command. If you send only one value, “-109 Missing parameter” is returned.
- When sending this query form of this command, the second element of the responded array is always present but only used when [:SENSe]:RADio:CARRier[:TYPE]:ACTual? returns O50.

Adjacent Channel Power—Define Offset Frequency List

iDEN mode (E4406A)

```
[:SENSe]:ACP:OFFSet[:FREQuency] <f_offset>
```

```
[:SENSe]:ACP:OFFSet[:FREQuency]?
```

Basic mode (E4406A),

```
[:SENSe]:ACP:OFFSet:LIST[:FREQuency]
```

```
<f_offset>,<f_offset>,<f_offset>,<f_offset>,<f_offset>
```

```
[:SENSe]:ACP:OFFSet:LIST[:FREQuency]?
```

WiDEN mode (E4406A)

```
[:SENSe]:ACP:OFFSet:LIST[:FREQuency]
```

```
<f_offset>,<f_offset>
```

```
[:SENSe]:ACP:OFFSet:LIST[:FREQuency]?
```


cdma2000, W-CDMA mode

```
[ :SENSe] :ACP:OFFSet [n] :LIST [ :FREQuency]
<f_offset>, <f_offset>, <f_offset>, <f_offset>, <f_offset>
```

```
[ :SENSe] :ACP:OFFSet [n] :LIST [ :FREQuency] ?
```

cdmaOne mode

```
[ :SENSe] :ACP:OFFSet [n] :LIST [m] [ :FREQuency]
<f_offset>, <f_offset>, <f_offset>, <f_offset>, <f_offset>
```

```
[ :SENSe] :ACP:OFFSet [n] :LIST [m] [ :FREQuency] ?
```

Enables you to define the custom set of offset frequencies at which the switching transient spectrum part of the ACP measurement will be made. The list contains up to five (5) entries, depending on the mode selected, for offset frequencies. Each offset frequency in the list corresponds to a reference bandwidth in the bandwidth list.

An offset frequency of zero turns the display of the measurement for that offset off, but the measurement is still made and reported. You can turn off (not use) specific offsets with the

[:SENSe]:ACP:OFFSet:LIST:STATe command (*not available in WiDEN mode (E4406A)*).

Offset[n] n=1 is base station and 2 is mobiles. The default is base station (1).

List[m] m=1 is cellular bands and 2 is pcs bands. The default is cellular.

Example: *WiDEN mode (E4406A)*:

(Example #1) When [:SENSe]:RADio:CARRier [:TYPE]:ACTual? returns I25, I50, I75, or I100, and you want to set the offset frequency of offset A to 100 kHz, send: ACP:OFFS:LIST 100e3, 10e3 (the second value can be arbitrary, but it is needed).

(Example #2) When [:SENSe]:RADio:CARRier [:TYPE]:ACTual? returns O50, and you want to set the offset frequencies of offset A and B to 75e3 and 10e3 respectively, send: ACP:OFFS:LIST 75e3, 10e3

State Saved: Saved in Instrument State

Factory Preset: *WiDEN mode (E4406A)*

Carrier Configuration Setting	Default	
	A	B
Auto	Actual value depends on detected carrier configuration and cannot be changed.	
25 kHz	25.0 kHz	N/A
50 kHz	37.5 kHz	N/A
50 kHz outer	62.5 kHz	12.5 kHz
75 kHz	50.0 kHz	N/A
100 kHz	62.5 kHz	N/A

Factory Preset: *iDEN mode (E4406A), Basic mode (E4406A), cdma2000, W-CDMA mode*

Mode	Variant	Offset A	Offset B	Offset C	Offset D	Offset E
iDEN (E4406A)		25 kHz	n/a	n/a	n/a	n/a
WiDEN (E4406A)		62.5 kHz	n/a	n/a	n/a	n/a
Basic (E4406A)		750 kHz	1.98 MHz	0 Hz	0 Hz	0 Hz
cdmaOne	BS cellular	750 kHz	1.98 MHz	0 Hz	0 Hz	0 Hz
	BS pcs	885 kHz	1.25625 MHz	2.75 MHz	0 Hz	0 Hz
	MS cellular	885 kHz	1.98 MHz	0 Hz	0 Hz	0 Hz
	MS pcs	1.265 MHz	0 Hz	0 Hz	0 Hz	0 Hz
cdma2000	BTS	750 kHz	1.98 MHz	0 Hz	0 Hz	0 Hz
	MS	885 kHz	1.98 MHz	0 Hz	0 Hz	0 Hz
W-CDMA		5 MHz	10 MHz	15 MHz	20 MHz	25 MHz

Range: 0 Hz to 45 MHz for cdmaOne
0 Hz to 20 MHz for iDEN, Basic, WiDEN (E4406A)
0 Hz to 100 MHz for cdma2000, W-CDMA

Default Unit: Hz

- Remarks:
- For PSA you must be in cdmaOne, cdma2000, or W-CDMA mode to use this command. Use INSTRument:SElect to set the mode.
- For E4406A you must be in Basic, cdmaOne, cdma2000, W-CDMA, WiDEN, or iDEN mode to use this command. Use INSTRument:SElect to set the mode.
- For E4406A WiDEN mode:
- When you set these values remotely, the position of each value in the list sent corresponds to the offset. Missing values are not permitted. For example, if you want to change the value of offset “B”, you must send all values up to 2.
 - The default values are set according to [:SENSe]:RADio:CARRier[:TYPE]:ACTual? setting as defined in Defaults table shown above.
 - If you have set Carrier Config ([:SENSe]:RADio:CARRier[:TYPE]) to AUTO, the value is set to the default value described in “Factory Preset:” above according to the actual carrier configuration detected (you can see detected carrier configuration by sending [:SENSe]:RADio:CARRier[:TYPE]:ACTual?) You can not change this value. Even if the you set this value using SCPI, it is ignored and the default value is used.
 - You must always send two <freq> values regardless of the [:SENSe]:RADio:CARRier[:TYPE] setting. The first value is for offset “A” and the second is for offset “B”. Note that the offset “B” value is only used when [:SENSe]:RADio:CARRier[:TYPE]? returns O50, but two values are always needed when the you send this command. If you send only one value, “-109 Missing parameter” is returned.
 - When sending this query form of this command, the second element of the responded array is always present but only used when [:SENSe]:RADio:CARRier[:TYPE]:ACTual? returns O50.

Key Path: **Meas Setup, Ofs & Limits**

Adjacent Channel Power—Amplitude Limits Relative to the Carrier

iDEN mode (E4406A)

```
[[:SENSe]:ACP:OFFSet:RCARrier <rel_power>
```

```
[[:SENSe]:ACP:OFFSet:RCARrier?
```

WiDEN mode (E4406A)

```
[[:SENSe]:ACP:OFFSet:LIST:RCARrier <rel_power>,<rel_power>
```

```
[[:SENSe]:ACP:OFFSet:LIST:RCARrier?
```

Basic mode (E4406A)

```
[[:SENSe]:ACP:OFFSet:LIST:RCARrier  
<rel_power>,<rel_power>,<rel_power>,<rel_power>,<rel_power>
```

```
[[:SENSe]:ACP:OFFSet:LIST:RCARrier?
```

cdma2000, W-CDMA mode

```
[[:SENSe]:ACP:OFFSet [n] :LIST:RCARrier  
<rel_power>,<rel_power>,<rel_power>,<rel_power>,<rel_power>
```

```
[[:SENSe]:ACP:OFFSet [n] :LIST:RCARrier?
```

cdmaOne mode

```
[[:SENSe]:ACP:OFFSet [n] :LIST [m] :RCARrier  
<rel_power>,<rel_power>,<rel_power>,<rel_power>,<rel_power>
```

```
[[:SENSe]:ACP:OFFSet [n] :LIST [m] :RCARrier?
```

Sets the amplitude levels to test against for any custom offsets. This amplitude level is relative to the carrier amplitude. If multiple offsets are available, the list contains five (5) entries. The offset closest to the carrier channel is the first one in the list.

[[:SENSe]:ACP:OFFSet[n]:LIST[m]:TEST selects the type of testing to be done at each offset.

You can turn off (not use) specific offsets with the [[:SENSe]:ACP:OFFSet[n]:LIST[m]:STATe command.

The query returns the five (5) sets of the real numbers that are the current amplitude test limits, relative to the carrier, for each offset.

Offset[n] n=1 is base station and 2 is mobiles. The default is base station (1).

List[m] m=1 is cellular bands and 2 is pcs bands. The default is cellular.

Factory Preset: *WiDEN mode (E4406A)*

Carrier Configuration Setting	Default	
	A	B
Auto	Actual value depends on detected carrier configuration and cannot be changed.	
25 kHz	-60.0 dB	N/A
50 kHz	-60.0 dB	N/A
50 kHz outer	-60.0 dB	-60.0 dB
75 kHz	-60.0 dB	N/A
100 kHz	-60.0 dB	N/A

Factory Preset:

Mode	Variant	Offset A	Offset B	Offset C	Offset D	Offset E
iDEN (E4406A)		0 dBc	n/a	n/a	n/a	n/a
Basic (E4406A)		-45 dBc	-60 dBc	0 dBc	0 dBc	0 dBc
cdmaOne	BS cellular	-45 dBc	-60 dBc	0 dBc	0 dBc	0 dBc
	BS pcs	-45 dBc	0 dBc	0 dBc	0 dBc	0 dBc
	MS cellular	-42 dBc	-54 dBc	0 dBc	0 dBc	0 dBc
	MS pcs	-42 dBc	0 dBc	0 dBc	0 dBc	0 dBc
cdma2000		0 dBc	0 dBc	0 dBc	0 dBc	0 dBc
W-CDMA	BTS	-44.2 dBc	-49.2 dBc	-49.2 dBc	-49.2 dBc	-49.2 dBc
	MS	-32.2 dBc	-42.2 dBc	-42.2 dBc	-42.2 dBc	-42.2 dBc

Range: -150.0 dB to 50.0 dB for cdmaOne, cdma2000, W-CDMA, Basic (E4406A), WiDEN (E4406A)
-200.0 dB to 50.0 dB for iDEN (E4406A)

Default Unit: dB

- Remarks: For PSA you must be in cdmaOne, cdma2000, or W-CDMA mode to use this command. Use INSTRument:SElect to set the mode.
- For E4406A you must be in Basic, cdmaOne, cdma2000, W-CDMA, WiDEN, or iDEN mode to use this command. Use INSTRument:SElect to set the mode.
- For E4406A WiDEN mode:
- When you set these values remotely, the position of each value in the list sent corresponds to the offset. Missing values are not permitted. For example, if you want to change the value of offset “B”, you must send all values up to 2.
 - The default values are set according to [:SENSe]:RADio:CARRier[:TYPE]:ACTual? setting as defined in Defaults table shown above.
 - If you have set Carrier Config ([:SENSe]:RADio:CARRier[:TYPE]) to AUTO, the value is set to the default value described in “Factory Preset:” above according to the actual carrier configuration detected (you can see detected carrier configuration by sending [:SENSe]:RADio:CARRier[:TYPE]:ACTual?) You can not change this value. Even if the you set this value using SCPI, it is ignored and the default value is used.
 - You must always send two <freq> values regardless of the [:SENSe]:RADio:CARRier[:TYPE] setting. The first value is for offset “A” and the second is for offset “B”. Note that the offset “B” value is only used when [:SENSe]:RADio:CARRier[:TYPE]? returns O50, but two values are always needed when the you send this command. If you send only one value, “-109 Missing parameter” is returned.
 - When sending this query form of this command, the second element of the responded array is always present but only used when [:SENSe]:RADio:CARRier[:TYPE]:ACTual? returns O50.
- Key Path: **Meas Setup, Ofs & Limits, Rel Lim (Car)** (iDEN or WiDEN mode)

Adjacent Channel Power—Amplitude Limits Relative to the Power Spectral Density

iDEN mode (E4406A)

```
[ :SENSE ] :ACP:OFFSet:RPSDensity <rel_power>
```

```
[ :SENSE ] :ACP:OFFSet:RPSDensity?
```

Basic mode (E4406A)

```
[ :SENSE ] :ACP:OFFSet:LIST:RPSDensity
```

```
<rel_power>,<rel_power>,<rel_power>,<rel_power>,<rel_power>
```

```
[ :SENSE ] :ACP:OFFSet:LIST:RPSDensity?
```

cdma2000, W-CDMA mode

```
[ :SENSE ] :ACP:OFFSet [n] :LIST:RPSDensity
```

```
<rel_power>,<rel_power>,<rel_power>,<rel_power>,<rel_power>
```

```
[ :SENSE ] :ACP:OFFSet [n] :LIST:RPSDensity?
```

cdmaOne mode

```
[ :SENSE ] :ACP:OFFSet [n] :LIST [m] :RPSDensity
```

```
<rel_power>,<rel_power>,<rel_power>,<rel_power>,<rel_power>
```

```
[ :SENSE ] :ACP:OFFSet [n] :LIST [m] :RPSDensity?
```

Sets the amplitude levels to test against for any custom offsets. This amplitude level is relative to the power spectral density. If multiple offsets are available, the list contains five (5) entries. The offset closest to the carrier channel is the first one in the list.

[:SENSE] :ACP:OFFSet [n] :LIST [m] :TEST selects the type of testing to be done at each offset.

You can turn off (not use) specific offsets with the [:SENSE] :ACP:OFFSet [n] :LIST :STATe command.

The query returns the five (5) sets of the real numbers that are the current amplitude test limits, relative to the power spectral density, for each offset.

Offset[n] n=1 is base station and 2 is mobiles. The default is base station (1).

List[m] m=1 is cellular bands and 2 is pcs bands. The default is cellular.

Factory Preset:

Mode	Variant	Offset A	Offset B	Offset C	Offset D	Offset E
iDEN (E4406A)		0 dB	n/a	n/a	n/a	n/a
Basic (E4406A)		-28.87 dB	-43.87 dB	0 dB	0 dB	0 dB
cdmaOne	BS cellular	-28.87 dB	-43.87 dB	0 dB	0 dB	0 dB
	BS pcs	-28.87 dB	0 dB	0 dB	0 dB	0 dB
	MS cellular	-25.87 dB	-37.87 dB	0 dB	0 dB	0 dB
	MS pcs	-25.87 dB	0 dB	0 dB	0 dB	0 dB
cdma2000		0 dB	0 dB	0 dB	0 dB	0 dB
W-CDMA	BTS	-44.2 dBc	-49.2 dBc	-49.2 dBc	-49.2 dBc	-49.2 dBc
	MS	-32.2 dBc	-42.2 dBc	-42.2 dBc	-42.2 dBc	-42.2 dBc

Range: -150.0 dB to 50.0 dB for cdmaOne, Basic, cdma2000, W-CDMA

-200.0 dB to 50.0 dB for iDEN (E4406A)

Default Unit: dB

Remarks: For PSA you must be in cdmaOne, cdma2000, or W-CDMA mode to use this command. Use INSTRUMENT:SElect to set the mode.

For E4406A you must be in Basic, cdmaOne, cdma2000, W-CDMA, or iDEN mode to use this command. Use INSTRUMENT:SElect to set the mode.

Adjacent Channel Power—Control Offset Frequency List

Basic mode (E4406A)

```
[ :SENSE ] :ACP:OFFSet:LIST:STATE OFF|ON|0|1, OFF|ON|0|1,  
OFF|ON|0|1, OFF|ON|0|1, OFF|ON|0|1
```

```
[ :SENSE ] :ACP:OFFSet:LIST:STATE?
```

cdma2000, W-CDMA mode

```
[ :SENSE ] :ACP:OFFSet [n] :LIST:STATE OFF|ON|0|1, OFF|ON|0|1,  
OFF|ON|0|1, OFF|ON|0|1, OFF|ON|0|1
```

```
[ :SENSE ] :ACP:OFFSet [n] :LIST:STATE?
```

cdmaOne mode

```
[ :SENSE ] :ACP:OFFSet [n] :LIST [m] :STATE OFF|ON|0|1,  
OFF|ON|0|1, OFF|ON|0|1, OFF|ON|0|1, OFF|ON|0|1
```

```
[ :SENSE ] :ACP:OFFSet [n] :LIST [m] :STATE?
```

Selects whether testing is to be done at the custom offset frequencies. The measured powers are tested against the absolute values defined with [:SENSE]:ACP:OFFSet:LIST:ABSolute, or the relative values defined with [:SENSE]:ACP:OFFSet:LIST:RPSDensity and [:SENSE]:ACP:OFFSet:LIST:RCARier.

Offset[n] n=1 is base station and 2 is mobiles. The default is base station (1).

List[m] m=1 is cellular bands and 2 is pcs bands. The default is cellular.

Factory Preset:

Mode	Variant	Offset A	Offset B	Offset C	Offset D	Offset E
Basic (E4406A)		On	On	On	On	On
cdmaOne	BS cellular	On	On	On	On	On
	BS pcs	On	On	On	On	On
	MS cellular	On	On	On	On	On
	MS pcs	On	On	On	On	On
cdma2000		On	On	Off	Off	Off
W-CDMA		On	On	Off	Off	Off

Remarks: For PSA and E4406A you must be in Basic (E4406A), cdmaOne, cdma2000, or W-CDMA mode to use this command. Use INSTRument:SElect to set the mode.

Adjacent Channel Power—Define Type of Offset Frequency List

iDEN or WiDEN mode (E4406A)

```
[[:SENSe]:ACP:OFFSet:TEST ABSolute|AND|OR|RELative
```

```
[[:SENSe]:ACP:OFFSet:TEST?
```

Basic mode (E4406A)

```
[[:SENSe]:ACP:OFFSet:LIST:TEST ABSolute|AND|OR|RELative,  
ABSolute|AND|OR|RELative, ABSolute|AND|OR|RELative,  
ABSolute|AND|OR|RELative, ABSolute|AND|OR|RELative
```

```
[[:SENSe]:ACP:OFFSet:LIST:TEST?
```

cdma2000, W-CDMA mode

```
[[:SENSe]:ACP:OFFSet [n]:LIST:TEST ABSolute|AND|OR|RELative,  
ABSolute|AND|OR|RELative, ABSolute|AND|OR|RELative,  
ABSolute|AND|OR|RELative, ABSolute|AND|OR|RELative
```

```
[[:SENSe]:ACP:OFFSet [n]:LIST:TEST?
```

cdmaOne mode

```
[[:SENSe]:ACP:OFFSet [n]:LIST [m]:TEST,  
ABSolute|AND|OR|RELative,  
ABSolute|AND|OR|RELative, ABSolute|AND|OR|RELative,  
ABSolute|AND|OR|RELative
```

```
[[:SENSe]:ACP:OFFSet [n]:LIST [nm]:TEST?
```

Defines the type of testing to be done at any custom offset frequencies. The measured powers are tested against the absolute values defined with `[[:SENSe]:ACP:OFFSet[n]:LIST:ABSolute]`, or the relative values defined with `[[:SENSe]:ACP:OFFSet:LIST:RPSDensity]` and `[[:SENSe]:ACP:OFFSet:LIST:RCARrier]`.

You can turn off (not use) specific offsets with the `[[:SENS]:ACP:OFFSet:LIST:STATe]` command. (Not $\alpha\omega\lambda\alpha\beta\lambda\epsilon$ in WiDEN mode.)

Offset[n] n=1 is base station and 2 is mobiles. The default is base station (1).

List[m] *cdmaOne mode* m=1 is cellular bands and 2 is pcs bands. The default is cellular.

cdma2000 mode m=1 is SR1, 2 is SR3 DS, and 3 is SR3 MC. The default is SR1 (1).

W-CDMA mode m=1 is ARIB, 2 is 3GPP, and 3 is Trial. The default is ARIB (1).

The types of testing that can be done for each offset include:

- Absolute - Test the absolute power measurement. If it fails, then return a failure for the measurement at this offset.
- And - Test both the absolute power measurement and the power relative to the carrier. If they both fail, then return a failure for the measurement at this offset.
- Or - Test both the absolute power measurement and the power relative to the carrier. If either one fails, then return a failure for the measurement at this offset.
- Relative - Test the power relative to the carrier. If it fails, then return a failure for the measurement at this offset.
- OFF - Turns the power test off.

Factory Preset:

Mode	Variant	Offset A	Offset B	Offset C	Offset D	Offset E
iDEN (E4406A)		REL	n/a	n/a	n/a	n/a
WiDEN (E4406A)		REL ^a	REL ^a	n/a	n/a	n/a
Basic (E4406A)		REL	REL	REL	REL	REL
cdmaOne	BS cellular	REL	REL	REL	REL	REL
	BS pcs	REL	ABS	ABS	REL	REL
	MS cellular	REL	REL	REL	REL	REL
	MS pcs	REL	ABS	ABS	REL	REL
cdma2000		REL	REL	REL	REL	REL
W-CDMA		REL	REL	REL	REL	REL

- a. Parameters for Offset A and Offset B are set by a common command, therefore they are always the same.

Remarks: For PSA you must be in cdmaOne, cdma2000, or W-CDMA mode to use this command. Use INSTRument:SElect to set the mode.

For E4406A you must be in Basic, cdmaOne, cdma2000, W-CDMA, WiDEN, or iDEN mode to use this command. Use INSTRument:SElect to set the mode.

Key Path: **Meas Setup, Ofs & Limits, Fail (iDEN)**
Meas Setup, Ofs & Limits, Composite Fail (WiDEN)

Adjacent Channel Power—Sweep Mode Resolution Bandwidth

```
[ :SENSe ] :ACP:SWEep:BANDwidth|BWIDth[:RESolution] <freq>  
[ :SENSe ] :ACP:SWEep:BANDwidth|BWIDth[:RESolution] ?
```

Sets the resolution bandwidth when using the spectrum analyzer type sweep mode. See [:SENSe] :ACP:SWEep:TYPE.

Factory Preset: Auto coupled.

Range: 1.0 kHz to 1.0 MHz

Resolution: 1.0 kHz

Step Size: 1.0 kHz

Default Unit: Hz

Remarks: You must be in the cdmaOne cdma2000, or W-CDMA mode to use this command. Use INSTRument:SElect to set the mode.

Adjacent Channel Power—Sweep Mode Resolution BW Control

```
[ :SENSe ] :ACP:SWEep:BANDwidth|BWIDth[:RESolution] :AUTO  
OFF|ON|0|1  
[ :SENSe ] :ACP:SWEep:BANDwidth|BWIDth[:RESolution] :AUTO?
```

Sets the resolution bandwidth to automatic, when using the spectrum analyzer type sweep mode. See [:SENSe] :ACP:SWEep:TYPE.

Factory Preset: ON

Remarks: You must be in the cdmaOne cdma2000, or W-CDMA mode to use this command. Use INSTRument:SElect to set the mode.

Adjacent Channel Power—Sweep Mode Detection

```
[ :SENSE ] :ACP:SWEep:DETEctor [ :FUNction ] AAverage | POSitive
[ :SENSE ] :ACP:SWEep:DETEctor [ :FUNction ] ?
```

Selects the detector type when using the sweep mode. See [:SENSE] :ACP:SWEep:TYPE.

Absolute average (AAverage) - the absolute average power in each frequency is measured across the spectrum

Positive - the positive peak power in each frequency is measured across the spectrum

Factory Preset: POSitive

Remarks: You must be in the cdma2000, or W-CDMA mode to use this command. Use INSTRument:SElect to set the mode.

Adjacent Channel Power—Sweep Time

```
[ :SENSE ] :ACP:SWEep:TIME <seconds>
[ :SENSE ] :ACP:SWEep:TIME?
```

Selects a specific sweep time used to measure the reference (carrier) channel. If you increase the sweep time, you increase the length of the time data captured and the number of points measured. You might need to specify a specific sweep speed to accommodate a specific condition in your transmitter. For example, you may have a burst signal and need to measure an exact portion of the burst.

Selecting a specific sweep time may result in a long measurement time since the resulting number of data points may not be the optimum 2^n . Use [:SENSE] :ACP:OFFSet:LIST:SWEep:TIME to set the number of points used for measuring the offset channels for Basic and cdmaOne.

For cdma2000 and W-CDMA, this command sets the sweep time when using the sweep mode. See [:SENSE] :ACP:SWEep:TYPE.

Factory Preset: 625 μ s (1 slot) for W-CDMA

1.25 ms for cdma2000

11.20 ms for Basic, cdmaOne

Range: 500 μ s to 10 ms for W-CDMA, cdma2000

1 μ s to 50 ms for Basic (E4406A), cdmaOne

Default Unit: seconds

Remarks: You must be in the Basic (E4406A), cdmaOne, cdma2000, or W-CDMA mode to use this command. Use INSTRument:SElect to set the mode.

History: E4406A:
Added to Basic revision A.03.00, to cdmaOne revision A.04.00

Adjacent Channel Power—Sweep Type

W-CDMA mode

```
[ :SENSe ] :ACP :SWEep :TYPE FAST | FFT | SWEep
```

```
[ :SENSe ] :ACP :SWEep :TYPE?
```

cdma2000 mode

```
[ :SENSe ] :ACP :SWEep :TYPE FFT | SWEep
```

```
[ :SENSe ] :ACP :SWEep :TYPE?
```

Selects the type of sweeping.

Fast (*W-CDMA mode only*) - the data acquisition is made with the wide channel integration bandwidth and the time-domain data is divided into the narrow data to apply FFT. This mode is faster than the FFT mode but less accurate in power levels.

FFT - the data acquisition is made with the narrow channel integration bandwidth and apply fast Fourier transform (FFT) to convert to the frequency domain data.

Sweep - the measurement is made by the swept spectrum method like the traditional swept frequency spectrum analysis to have better correlation to the input signal with a high crest factor (peak/average ratio). This mode may take a longer time than the FFT mode. See [:SENSe] :ACP :SWEep :DETEctor [:FUNction] .

Factory Preset: FFT

Remarks: You must be in the cdma2000, or W-CDMA mode to use this command. Use INSTRument:SElect to set the mode.

Adjacent Channel Power—Power Reference

`[:SENSe] :ACP:TYPE PSDRef | TPreF`

`[:SENSe] :ACP:TYPE?`

Selects the measurement type. This allows you to make absolute and relative power measurements of either total power or the power normalized to the measurement bandwidth.

Power Spectral Density Reference (PSDRef) - the power spectral density is used as the power reference

Total Power Reference (TPRef) - the total power is used as the power reference

Factory Preset: Total power reference (TPRef)

Remarks:

For E4406A you must be in the Basic, cdmaOne, cdma2000, W-CDMA, NADC, or PDC mode to use this command. Use `INSTRument:SElect` to set the mode.

For PSA you must be in the cdmaOne, cdma2000, W-CDMA, NADC, or PDC mode to use this command. Use `INSTRument:SElect` to set the mode.

Baseband I/Q Commands (E4406A only)

Baseband I/Q - Select I/Q Power Range

```
[ :SENSe ] :POWer :IQ :RANGe [ :UPPer ] <power> [ DBM ] | DBMV | W
```

```
[ :SENSe ] :POWer :IQ :RANGe [ :UPPer ] ?
```

Selects maximum total power expected from unit under test at test port when I or Q port is selected.

Range: For 50 Ohms:

13.0, 7.0, 1.0, or -5.1 dBm
60.0, 54.0, 48.0, or 41.9 dBmV
0.02, 0.005, 0.0013, or 0.00031 W

For 600 Ohms:

2.2, -3.8, -9.8, or -15.8 dBm
60.0, 54.0, 48.0, or 41.9 dBmV
0.0017, 0.00042, 0.0001, or 0.000026 W

For 1 M Ohm:

Values for 1 M Ohm vary according to selected reference impedance.

Default Units: DBM

Remarks: You must be in the Basic, W-CDMA, cdma2000, or EDGE with GSM mode to use this command. Use INSTRument:SElect to set the mode.

History: Added revision A.05.00 for B, WC, C2
Added revision A.06.00 for E

Baseband I/Q - Select I/Q Voltage Range

```
[ :SENSe ] :VOLTage:IQ:RANGe [:UPPer] <level>
```

```
[ :SENSe ] :VOLTage:IQ:RANGe [:UPPer] ?
```

Selects upper voltage range when I or Q port is selected. This setting helps set the gain which is generated in the variable gain block of the baseband IQ board to improve dynamic range.

Range: 1.0, 0.5, 0.25, or 0.125 volts

Default Units: V

Remarks: You must be in the Basic, W-CDMA, cdma2000, or EDGE with GSM mode to use this command. Use INSTRument:SElect to set the mode.

History: Added revision A.05.00 for B, WC, C2
Added revision A.06.00 for E

Code Domain Measurement

Commands for querying the code domain power measurement results and for setting to the default values are found in the “[MEASure Group of Commands](#)” on page 654. The equivalent front-panel keys for the parameters described in the following commands, are found under the **Meas Setup** key, after the **Code Domain** measurement has been selected from the **MEASURE** key menu.

Code Domain — ADC Range

PSA and 14-bit ADC E4406A

```
[ :SENSe ] :CDPower:ADC:RANGe
```

```
AUTO | APEak | APLOCK | NONE | P0 | P6 | P12 | P18
```

12-bit ADC E4406A

```
[ :SENSe ] :CDPower:ADC:RANGe
```

```
AUTO | APEak | APLOCK | M6 | P0 | P6 | P12 | P18 | P24
```

```
[ :SENSe ] :CDPower:ADC:RANGe?
```

Select a ranging function for the ADC gain control. This is an advanced control that normally does not need to be changed. If you are measuring a CW signal, see the following description:

- AUTO - automatic ranging

For FFT spectrums, the auto ranging should not be used. An exception to this would be if you know that your signal is “bursty”. Then you might use auto to maximize the time domain dynamic range as long as you are not very interested in the FFT data.

Range For all PSA and VSA with 14bit ADC, the available choices are:
Auto | Auto Peak | AutoPeakLock | None | 0dB | +6dB | +12dB | +18dB
and the preset/default value is None (NONE).

For VSA with 12bit ADC, the available choices are:
Auto | Auto Peak | AutoPeakLock | -6dB | 0dB | +6dB | +12dB | +18dB | +24dB
and the preset/default value is -6dB (M6).

Key Path **Meas Setup, More, More, Advanced**

Factory Preset: M6

Remarks: You must be in the 1xEV-DO mode to use this command. Use INSTRument:SElect to set the mode.

History: PSA:
Added in version A.02.00
E4406A:
Added in version A.05.00

Code Domain—Demod Alpha

`[:SENSe] :CDPower:ALPHa <numeric>`

`[:SENSe] :CDPower:ALPHa?`

Set alpha for the root Nyquist filter.

Preset 0.22

State Saved Saved in instrument state.

SCPI Resolution 0.01

Key Path **Meas Setup, More, More, Advanced**

Range: 0.01 to 0.5

Remarks: You must be in the W-CDMA mode to use this command. Use INSTRument:SElect to set the mode.

Code Domain—Data Capture Time

`[:SENSe] :CDPower :CAPTure :TIME <numeric>`

`[:SENSe] :CDPower :CAPTure :TIME?`

Set the data capture length in Power Control Groups (PCG; 1 PCG equals 1.25 ms) for cdma2000 and 1xEV-DO, or frames (1 frame equals 10 ms) for W-CDMA that will be used in the acquisition.

For cdma2000 Set the data capture length in Power Control Groups (PCG; 1 PCG equals 1.25 ms) that will be used in the acquisition.

For 1xEV-DO Set the data capture length in units of slots (1 slot equals 1.667 ms) that will be used in the acquisition.

For W-CDMA Set the data capture length in frames (1 frame equals 10 ms) for that will be used in the acquisition.

Factory Preset: 5 for cdma2000, 1xEV-DO
1.0 for W-CDMA

Range: 2 to 32 PCGs (2.5 to 40 ms) for cdma2000; 2 to 32 slots for 1xEV-DO
0.067 (any value below 1 is set to 0.067), 1.0, 2.0, 3.0, 4.0, and 8.0 frames (0.67 to 80 ms; 1/15 frame equals 1 slot) for W-CDMA. Other numeric values between 1 and 8 are rounded to the nearest integer; entries between integers are rounded up, excepting for entries above 8 which are rounded down to 8.

Remarks: You must be in the cdma2000, W-CDMA, or 1xEV-DO mode to use this command. Use INSTRument:SElect to set the mode.

Code Domain—Chip Rate

`[:SENSe] :CDPower:CRATe <freq>`

`[:SENSe] :CDPower:CRATe?`

Enter a frequency value to set the chip rate.

Preset	3.84 MHz
State Saved	Saved in instrument state.
SCPI Resolution	1.0 kHz
Key Path	Meas Setup, More, More, Advanced
Front-panel Unit/Terminator Keys	Hz kHz MHz GHz
Unit/Terminator Keys	Hz kHz MHz GHz
Range:	1.10592 to 1.35168 MHz for cdma2000, 1xEV-DO 3.456 to 4.224 MHz for W-CDMA
Remarks:	You must be in the cdma2000, W-CDMA, or 1xEV-DO mode to use this command. Use INSTRument:SElect to set the mode.

Code Domain - Frequency Error Tolerance Range

`[:SENSe] :CDPower:FERRor:TRANge WIDE | NORMAl`

`[:SENSe] :CDPower:FERRor:TRANge?`

Frequency error tolerance range is specified:

- Normal
- Wide

‘Wide’ provides a wider, or more loose, range of frequency error tolerance. To correctly demodulate signals of higher complexity, a more stringent frequency tolerance is required. For example, when composite channels are modulated on the same signal, the modulation is complex, and frequency error is critical to correct demodulation. In the case of demodulating complex signal, set to ‘Normal’.

This parameter is valid only when the device type is ‘MS’ (Uplink). When set to ‘BTS’ (Downlink), MUI is disabled (grayed out).

Example `:SENSe:CDPower:FERRor:TRANge WIDE`

Notes	No
Dependencies and Couplings	No
Preset	NORMal
State Saved	Saved in instrument state.
Range	WIDE NORMal
Key Path	Meas Setup, More, More, Advanced, More

Code Domain - Multi Channel Estimator

```
[ :SENSe ] :CDPower:MCEstimator OFF | ON | 0 | 1
```

```
[ :SENSe ] :CDPower:MCEstimator?
```

Allows you to toggle the multi channel estimator function by MMSE between On and Off.

On : The individual code channels are aligned to the pilot channel to improve the phase error (whether each code phase is aligned or not). This takes a longer time.

Off : The phase information is computed from one coded signal only. (The phase of each code channel needs to be aligned to the pilot channel.)

Example	:SENSe:CDPower:MCEstimator ON
Preset	OFF
State Saved	Saved in instrument state.
Range	On Off
Key Path	Meas Setup, More, More, Advanced, More

Code Domain - MICH Code Number

```
[ :SENSe ] :CDPower:MICH:SPRead <integer>
```

```
[ :SENSe ] :CDPower:MICH:SPRead?
```

```
[ :SENSe ] :CDPower:MICH:STATe OFF | ON | 0 | 1
```

```
[ :SENSe ] :CDPower:MICH:STATe?
```

It specifies the code number of MICH (MBMS Indicator channel), which has the DTX (no transmission) part. MICH has 300 bits in 1 radio frame, but last 6 symbols (12 bits) are not transmitted. Therefore, MICH needs the special handling to measure the code domain power. MICH Code Number specifies which code channel should be considered as MICH.

Since MICH is optional channel, the parameter can be enabled or disabled (On | Off).

NOTE

Active ID auto-detection is done by the algorithm regardless of this parameter. However, the result could be 7.5ksps channel if MICH's two consecutive demod bits are the same. This UI forces such 7.5ksps channels to be 15ksps channels.

Example	:SENSe:CDPower:MICH:SPRead 4 :SENSe:CDPower:MICH:STATe ON
Notes	(1) If PICH Code Number () and MICH Code Number are the same, the channel is considered as PICH. (2) This parameter is active for BTS. It is grayed out for MS. (3) This parameter is meaningful only if Symbol Boundary setting is Auto.
Remote Command Notes	This parameter enables or disables MICH code number setting.
Preset	2, , Off
State Saved	Saved in instrument state.
Range	2 – 255
Key Path	Meas Setup, More, More, Advanced

Code Domain - PICH Code Number

It specifies the code number of PICH (Paging Indicator Channel), which has the DTX (no transmission) part. PICH has 300 bits in 1 radio frame, but last 12 bits are not transmitted. Therefore, PICH needs the special handling to measure the code domain power. PICH Code Number specifies which code channel should be considered as PICH.

NOTE

Active ID auto-detection is done by the algorithm regardless of this parameter. However, the result could be 7.5ksps channel if PICH's two consecutive demod bits are the same. This UI forces such 7.5ksps channels to be 15ksps channels.

Example	:SENSe:CDPower:PICH:SPRead 4
Notes	(1) If PICH Code Number and MICH Code Number () are the same, the channel is considered as PICH. (2) This parameter is active for BTS. It is grayed out for MS. (3) This parameter is meaningful only if Symbol Boundary setting is Auto.
Preset	16
State Saved	Saved in instrument state.
Range	2 – 255
Key Path	Meas Setup, More, More, Advanced

Code Domain - Timing Estimation

```
[ :SENSe ] :CDPower:MCEstimator:TIMing CHANnel | GLOBal
```

```
[ :SENSe ] :CDPower:MCEstimator:TIMing?
```

Allows you to select timing estimation function by MMSE between channel-by-channel and global.

Channel-by-Channel - The code channels are estimated using individual channel timing. This takes longer.

Global : The individual code channels are estimated using global timing.

Example	:SENSe:CDPower:MCEstimator:TIMing CHANnel
Dependencies and Couplings	Only when Multi Channel Estimator is ON, this parameter is valid. When Multi Channel Estimator is OFF, MUI(Softkey) is grayed out
Preset	GLOBal
State Saved	Saved in instrument state.
Range	CHANnel GLOBal
Key Path	Meas Setup, More, More, Advanced, More

Code Domain - PRACH Preamble Signature (MS)

```
[ :SENSe ] :CDPower:PRACH:SIGNature <integer>
```

```
[ :SENSe ] :CDPower:PRACH:SIGNature?
```

```
[ :SENSe ] :CDPower:PRACH:SIGNature:AUTO OFF | ON | 0 | 1
```

```
[ :SENSe ] :CDPower:PRACH:SIGNature:AUTO?
```

Set Preamble Signature number for PRACH Message detection. Based on this value, the code allocation of PRACH message control part is calculated. This command is effective when the [:SENSe]:CDPower:SYNC:MS command is set to PMESsage (PRACH Message).

PRACH message (Control) has only Slot Format #0. The field lengths are defined as the table below. Demod attribute information is colored according to the given Slot Format parameter. Using input parameter Slot Format #i, bit data is colored accordingly (e.g. Npilot and NTFCI).

SCPI Resolution	1
Key Path	Meas Setup, More

Code Domain - Symbol Boundary Custom Active Channel List MS Initialize [MS only]

```
:SENSe] :CDPower:SBOundary:LIST:MS:INIT <symbol_rate>,
<code_num>, IPH|QPH
```

This initializes the the current custom active channel list. This creates a new entry with the given parameter.

1st parameter:

<symbol_rate> This parameter specifies symbol rate of the channel.

2nd parameter:

<code_num> This parameter specifies spreading code of the channel.

3rd parameter:

IPH Specifies the channel is on I-axis.

QPH Specifies the channel Is on Q-axis.

Example

In order to predefine the following channels:

- DPCCH (C8(0):Q)
- DPDCH (C6(16):I)

```
:SENSE:CDPower:SBOundary:LIST:MS:INIT  
15000, 0, QPH  
:SENSE:CDPower:SBOundary:LIST:MS:APPend  
60000, 16, IPH
```

```
:SENSE:CDPower:SBOundary:LIST:MS:NCHann  
els?  
2
```

```
:SENSE:CDPower:SBOundary:LIST:MS:CHANne  
l? 1  
15000, 0, QPH
```

```
:SENSE:CDPower:SBOundary:LIST:MS:CHANne  
l? 2  
60000, 16, IPH
```

Notes

- (1) This command is effective if
[:SENSE]:RADio:DEvice is set to MS and
[:SENSE]:CDPower:SBOundary:MS is set to
CUSTom.
- (2) symbol_rate = 1920000 is available if
HSDPA/HSUPA Enable is On.
- (3) The maximum number of entries is 512.

Remote Command
Notes

One of the following error messages will be logged if the given parameter is invalid.

If error is reported, the SCPI command is rejected and instrument's settings does not change.

(1) "Missing Parameter" (PSA: -109, E4406A VSA: -109)

This error is reported if the number of parameters is less than 3.

For example:

```
:SENSe:CDPower:SBOundary:LIST:MS:INIT
15000, 0 ? 3rd parameter is missing.
```

(2) "Illegal parameter value" (PSA: -224, E4406A VSA: -224) This error is reported if parameter type is invalid or if enum value is invalid.

For example:

```
:SENSe:CDPower:SBOundary:LIST:MS:INIT
15000, ON, QPH ? 2nd parameter must be integer.
:SENSe:CDPower:SBOundary:LIST:MS:INIT
15001, 0, QPH ? 1st parameter value (Symbol
Rate) is not allowed.
```

Only the values given in Range field are valid for the Symbol Rate. You may specify these in numeric form, but they are interpreted as an enumeration and the error will result if the value does not translate to one in the list.

(3) "Data out of range" (PSA: -222, E4406A VSA: -222) This error is reported if parameter value is out of range.

For example:

```
:SENSe:CDPower:SBOundary:LIST:MS:INIT
15000, 256, QPH ? 2nd parameter is out of range.
```

(4) "Setting Conflict" (PSA: -221, E4406A VSA: -221) This error is reported if the given code channel overlaps other code channel on code domain.

For example: If a user sends the following two commands, the second command causes the error message because C7(0):Q overlaps C8(0):Q.

```
:SENSe:CDPower:SBOundary:LIST:MS:INIT
15000, 0, QPH ? OK
```

```
:SENSe:CDPower:SBOundary:LIST:MS:APPend
30000, 0, QPH ? C7(0):Q overlaps C8(0):Q
```

State Saved

Saved in instrument state.

Range	symbol_rate = 15000 30000 60000 120000 240000 480000 960000 1920000 0<= code_num <= 255 if symbol_rate = 15000 0<= code_num <= 127 if symbol_rate = 30000 0<= code_num <= 63 if symbol_rate = 60000 0<= code_num <= 31 if symbol_rate = 120000 0<= code_num <= 15 if symbol_rate = 240000 0<= code_num <= 7 if symbol_rate = 480000 0<= code_num <= 3 if symbol_rate = 960000 0<= code_num <= 1 if symbol_rate = 1920000
Key Path	no support (SCPI only)

Code Domain - Symbol Boundary Custom Active Channel List MS Append [MS only]

```
[ :SENSe ] :CDPower:SBOundary:LIST:MS:APPend <symbol_rate>, <code_num>, IPH|QPH
```

This command appends the entry of the custom active channel list.

1st parameter:

<symbol_rate> This parameter specifies symbol rate of the channel.

2nd parameter:

<code_num> This parameter specifies spreading code of the channel.

3rd parameter:

IPH Specifies the channel is on I-axis.

QPH Specifies the channel is on Q-axis.

Example

In order to predefine the following channels:

- DPCCH (C8(0):Q)
- DPDCH (C6(16):I)

```
:SENSe:CDPower:SBOundary:LIST:MS:INIT  
15000, 0, QPH  
:SENSe:CDPower:SBOundary:LIST:MS:APPend  
60000, 16, IPH
```

```
:SENSe:CDPower:SBOundary:LIST:MS:NCHann  
els?  
2
```

```
:SENSe:CDPower:SBOundary:LIST:MS:CHANnel  
? 1  
15000, 0, QPH
```

```
:SENSe:CDPower:SBOundary:LIST:MS:CHANnel  
? 2  
60000, 16, IPH
```

Notes

- (1) This command is effective if
[:SENSe]:RADio:DEVIce is set to MS and
[:SENSe]:CDPower:SBOundary:MS is set to
CUSTom.
- (2) symbol_rate = 1920000 is available if
HSDPA/HSUPA Enable is On.
- (3) The maximum number of entries is 512.

Remote Command
Notes

One of the following error messages will be logged if the given parameter is invalid.

If error is reported, the SCPI command is rejected and instrument's settings does not change.

(1) "Missing Parameter" (PSA: -109, E4406A VSA: -109)

This error is reported if the number of parameters is less than 3.

For example:

```
:SENSe:CDPower:SBOundary:LIST:MS:INIT  
15000, 0 ? 3rd parameter is missing.
```

(2) "Illegal parameter value" (PSA: -224, E4406A VSA: -224) This error is reported if parameter type is invalid or if enum value is invalid.

For example:

```
:SENSe:CDPower:SBOundary:LIST:MS:INIT  
15000, ON, QPH ? 2nd parameter must be integer.  
:SENSe:CDPower:SBOundary:LIST:MS:INIT  
15001, 0, QPH ? 1st parameter value (Symbol  
Rate) is not allowed.
```

Only the values given in Range field are valid for the Symbol Rate. You may specify these in numeric form, but they are interpreted as an enumeration and the error will result if the value does not translate to one in the list.

(3) "Data out of range" (PSA: -222, E4406A VSA: -222) This error is reported if parameter value is out of range.

For example:

```
:SENSe:CDPower:SBOundary:LIST:MS:INIT  
15000, 256, QPH ? 2nd parameter is out of range.
```

(4) "Setting Conflict" (PSA: -221, E4406A VSA: -221) This error is reported if the given code channel overlaps other code channel on code domain.

For example: If a user sends the following two commands, the second command causes the error message because C7(0):Q overlaps C8(0):Q.

```
:SENSe:CDPower:SBOundary:LIST:MS:INIT  
15000, 0, QPH ? OK
```

```
:SENSe:CDPower:SBOundary:LIST:MS:APPend  
30000, 0, QPH ? C7(0):Q overlaps C8(0):Q
```

State Saved

Saved in instrument state.

Range	symbol_rate = 15000 30000 60000 120000 240000 480000 960000 1920000
	0<= code_num <= 255 if symbol_rate = 15000
	0<= code_num <= 127 if symbol_rate = 30000
	0<= code_num <= 63 if symbol_rate = 60000
	0<= code_num <= 31 if symbol_rate = 120000
	0<= code_num <= 15 if symbol_rate = 240000
	0<= code_num <= 7 if symbol_rate = 480000
	0<= code_num <= 3 if symbol_rate = 960000
	0<= code_num <= 1 if symbol_rate = 1920000
Key Path	no support (SCPI only)

Code Domain - Symbol Boundary Custom Active Channel List MS Replace [MS only]

```
[ :SENSe ] :CDPower :SBOundary :LIST :MS :REPLace <entry_id> ,  
<symbol_rate> , <code_num> , IPH | QPH
```

This command replaces the entry of the custom active channel list.

1st parameter:

<entry_id This parameter specifies entry ID of the channel to replace.
>

2nd parameter:

<symbol_r This parameter specifies symbol rate of the channel.
ate>

3rd parameter:

<code_nu This parameter specifies spreading code of the channel.
m>

4th parameter:

IPH Specifies the channel is on I-axis.

QPH Specifies the channel Is on Q-axis.

Example In order to predefine the following channels:

- DPCCH (C8(0):Q)
- DPDCH (C6(16):I)

```
:SENSE:CDPower:SBOundary:LIST:MS:INIT  
15000, 0, QPH  
:SENSE:CDPower:SBOundary:LIST:MS:APPend  
60000, 16, IPH
```

```
:SENSE:CDPower:SBOundary:LIST:MS:NCHann  
els?  
2
```

And, replace 2nd entry.

```
:SENSE:CDPower:SBOundary:LIST:MS:REPLace  
2, 60000,17,QPH
```

```
:SENSE:CDPower:SBOundary:LIST:MS:CHANne  
l? 1  
15000, 0, QPH
```

```
:SENSE:CDPower:SBOundary:LIST:MS:CHANne  
l? 2  
60000, 17, IPH
```

Notes

- (1) This command is effective if
[:SENSE]:RADio:DEVIce is set to MS and
[:SENSE]:CDPower:SBOundary:MS is set to
CUSTom.
- (2) symbol_rate = 1920000 is available if
HSDPA/HSUPA Enable is On.
- (3) The maximum number of entries is 512.

Remote Command
Notes

One of the following error messages will be logged if the given parameter is invalid.

If error is reported, the SCPI command is rejected and instrument's settings does not change.

(1) "Missing Parameter" (PSA: -109, E4406A VSA: -109)

This error is reported if the number of parameters is less than 3.

For example:

```
:SENSe:CDPower:SBOundary:LIST:MS:INIT
15000, 0 ? 3rd parameter is missing.
```

(2) "Illegal parameter value" (PSA: -224, E4406A VSA: -224) This error is reported if parameter type is invalid or if enum value is invalid.

For example:

```
:SENSe:CDPower:SBOundary:LIST:MS:INIT
15000, ON, QPH ? 2nd parameter must be
integer.
```

```
:SENSe:CDPower:SBOundary:LIST:MS:INIT
15001, 0, QPH ? 1st parameter value (Symbol
Rate) is not allowed.
```

Only the values given in Range field are valid for the Symbol Rate. You may specify these in numeric form, but they are interpreted as an enumeration and the error will result if the value does not translate to one in the list.

(3) "Data out of range" (PSA: -222, E4406A VSA: -222) This error is reported if parameter value is out of range.

For example:

```
:SENSe:CDPower:SBOundary:LIST:MS:INIT
15000, 256, QPH ? 2nd parameter is out of range.
```

(4) "Setting Conflict" (PSA: -221, E4406A VSA: -221) This error is reported if the given code channel overlaps other code channel on code domain.

For example: If a user sends the following two commands, the second command causes the error message because C7(0):Q overlaps C8(0):Q.

```
:SENSe:CDPower:SBOundary:LIST:MS:INIT
15000, 0, QPH ? OK
```

```
:SENSe:CDPower:SBOundary:LIST:MS:APPend
30000, 0, QPH ? C7(0):Q overlaps C8(0):Q
```

State Saved

Saved in instrument state.

Range

The entry ID must be:

1 <= entry_id <= The number of entries which have been defined. (See REF_Ref123466816 \r \h - Symbol Boundary Custom Active Channel List – The Number Of Entries MS [MS only])

symbol_rate = 15000 | 30000 | 60000 | 120000 | 240000 | 480000 | 960000 | 1920000

0 <= code_num <= 255 if symbol_rate = 15000

0 <= code_num <= 127 if symbol_rate = 30000

0 <= code_num <= 63 if symbol_rate = 60000

0 <= code_num <= 31 if symbol_rate = 120000

0 <= code_num <= 15 if symbol_rate = 240000

0 <= code_num <= 7 if symbol_rate = 480000

0 <= code_num <= 3 if symbol_rate = 960000

0 <= code_num <= 1 if symbol_rate = 1920000

Key Path

no support (SCPI only)

Code Domain - Symbol Boundary Custom Active Channel List MS Query [MS only]

`[:SENSE] :CDPower :SBOundary :LIST :MS :CHANnel? <entry_id>`

This command returns the entry of the custom active channel list.

1st parameter:

<entry_id> This parameter specifies entry ID of the channel to query

Example In order to predefine the following channels:
- DPCCH (C8(0):Q)
- DPDCH (C6(16):I)

```
:SENSE:CDPower:SBOundary:LIST:MS:INIT
15000, 0, QPH
```

```
:SENSE:CDPower:SBOundary:LIST:MS:APPend
60000, 16, IPH
```

```
:SENSE:CDPower:SBOundary:LIST:MS:NCHann
els?
2
```

```
:SENSE:CDPower:SBOundary:LIST:MS:CHANne
l? 1
15000, 0, QPH
```

```
:SENSE:CDPower:SBOundary:LIST:MS:CHANne
l? 2
60000, 16, IPH
```

Notes

- (1) This command is effective if `[:SENSE] :RADio :DEvice` is set to MS and `[:SENSE] :CDPower :SBOundary :MS` is set to CUSTom.
- (2) `symbol_rate = 1920000` is available if HSDPA/HSUPA Enable is On.
- (3) The maximum number of entries is 512.

Remote Command Notes	<p>Default value of the parameter</p> <p>By default, there is one channel defined. (DPCCH C8(0):Q) In order to query the default entry, specify 1 for <entry_id>: :SENSE:CDPower:SBOundary:LIST:MS:CHANnel? 1 The instrument will return an array of three values: 15000, 0, QPH</p> <p>Query command needs <entry_id> parameter</p> <p><entry_id> parameter is always required for query command. The range of the parameter is from 1 to the total number of channels you have defined. For example, if you have defined two channels, you can query them as follows: :SENSE:CDPower:SBOundary:LIST:MS:CHANnel? 1 :SENSE:CDPower:SBOundary:LIST:MS:CHANnel? 2</p> <p>If you want to know the number of channels you have defined, send the following query command: :SENSE:CDPower:SBOundary:LIST:MS:NChannels?</p>
Preset	15000, 0, QPH
State Saved	Saved in instrument state.
Range	<p>The entry ID must be:</p> <p>1 <= entry_id <= The number of entries which have been defined. (See REF_Ref123466816 \r \h - Symbol Boundary Custom Active Channel List – The Number Of Entries MS [MS only])</p>
Key Path	no support (SCPI only)

Code Domain - Symbol Boundary Custom Active Channel List – The Number Of Entries MS [MS only]

`[:SENSE] :CDPower :SBOundary :LIST :MS :NChannels?`

This query-only command returns the number of entries in the custom predefined active channel list MS.

Example	<code>:SENSE:CDPower:SBOundary:LIST:MS:NChannels?</code>
Notes	This command is effective when <code>[:SENSE] :RADio :DEVice</code> is set to MS and <code>[:SENSE] :CDPower :SBOundary :MS</code> is set to CUSTom.
Remote Command Notes	This command is a query-only command.
Preset	1
State Saved	No
Key Path	no support (SCPI only)

Code Domain - Symbol Boundary Custom Active Channel List – The Number Of Entries BTS [BTS only]

[[:SENSe]:CDPower:SBOundary:LIST[:BTS]:NCHannels?

This query-only command returns the number of entries in the custom predefined active channel list BTS.

Example	:SENSe:CDPower:SBOundary:LIST:BTS:NCHannels?
Notes	This command is effective when [:SENSe]:RADio:DEVice is set to BTS and [:SENSe]:CDPower:SBOundary[:BTS] is set to CUSTom.
Remote Command Notes	This command is a query-only command.
Preset	1
State Saved	No
Key Path	no support (SCPI only), Symbol Boundary Custom Active Channel List – The Number Of Entries BTS [BTS only]
History	PSA A.09 and E4406A VSA A.10 and later versions support this parameter.

Code Domain - Symbol Boundary Custom Active Channel List BTS [BTS only]

[[:SENSe]:CDPower:SBOundary:LIST[:BTS]:INIT
<symbol_rate>, <code_num>, QPSK|QAM16

This command creates the list of custom predefined channels for BTS.

1st parameter:

INIT	This choice clears the current custom predefined active channel list. Then it creates a new entry with the given parameter.
APPend	This choice adds a new entry to the end of the list.
<entry_id>	This choice replaces an entry specified with <entry_id>. If used for query, it specifies the entry ID to be queried. (Entry ID:1, 2, ..., the total number of entries in the list)

2nd parameter:

<symbol_rate> This parameter specifies symbol rate of the channel.

3rd parameter:

<code_num> This parameter specifies code number of the channel.

4th parameter:

QPSK Specifies the channel's modulation scheme is QPSK.

QAM16 Specifies the channel's modulation scheme is QAM16.
This choice is available only for channels with symbol
rate 240000.

Example

In order to predefine the following channels:

```
- CPICH (C8(0))
- P-CCPCH (C8(1))
- S-CCPCH(C8(3))
- PICH(C8(16))
- HS-PDSCH (C4(15)) 16QAM modulated

:SENSe:CDPower:SBOundary:LIST:BTS:INIT
15000,0, QPSK
:SENSe:CDPower:SBOundary:LIST:BTS:APPend
15000,1, QPSK
:SENSe:CDPower:SBOundary:LIST:BTS:APPend
15000,3, QPSK
:SENSe:CDPower:SBOundary:LIST:BTS:APPend
15000,16, QPSK
:SENSe:CDPower:SBOundary:LIST:BTS:APPend
240000,15, QAM16

:SENSe:CDPower:SBOundary:LIST:BTS:NCHan
nels?
5

:SENSe:CDPower:SBOundary:LIST:BTS:CHANn
el? 1
15000,0, QPSK
:SENSe:CDPower:SBOundary:LIST:BTS:CHANn
el? 2
15000,1, QPSK
:SENSe:CDPower:SBOundary:LIST:BTS:CHANn
el? 3
15000,3, QPSK
:SENSe:CDPower:SBOundary:LIST:BTS:CHANn
el? 4
15000,16, QPSK
:SENSe:CDPower:SBOundary:LIST:BTS:CHANn
el? 5
240000,15, QAM16
```

Notes

- (1) This command is effective when [:SENSe]:RADio:DEVice is set to BTS and [:SENSe]:CDPower:SBOundary[:BTS] is set to CUSTom.
- (2) QAM16 for the 4th parameter is available only if HSDPA/HSUPA Enable is On

Remote Command
Notes

One of the following error messages will be logged if the given parameter is invalid.

If error is reported, the SCPI command is rejected and instrument's settings does not change.

(1) "Missing Parameter" (PSA: -109, E4406A VSA: -109)

This error is reported if the number of parameters is less than 3.

For example:

```
:SENSe:CDPower:SBOundary:LIST:MS:INIT
15000, 0 ? 3rd parameter is missing.
```

(2) "Illegal parameter value" (PSA: -224, E4406A VSA: -224) This error is reported if parameter type is invalid or if enum value is invalid.

For example:

```
:SENSe:CDPower:SBOundary:LIST:MS:INIT
15000, ON, QPH ? 2nd parameter must be
integer.
```

```
:SENSe:CDPower:SBOundary:LIST:MS:INIT
15001, 0, QPH ? 1st parameter value (Symbol
Rate) is not allowed.
```

Only the values given in Range field are valid for the Symbol Rate. You may specify these in numeric form, but they are interpreted as an enumeration and the error will result if the value does not translate to one in the list.

(3) "Data out of range" (PSA: -222, E4406A VSA: -222) This error is reported if parameter value is out of range.

For example:

```
:SENSe:CDPower:SBOundary:LIST:MS:INIT
15000, 256, QPH ? 2nd parameter is out of range.
```

(4) "Setting Conflict" (PSA: -221, E4406A VSA: -221) This error is reported if the given code channel overlaps other code channel on code domain.

For example: If a user sends the following two commands, the second command causes the error message because C7(0):Q overlaps C8(0):Q.

```
:SENSe:CDPower:SBOundary:LIST:MS:INIT
15000, 0, QPH ? OK
```

```
:SENSe:CDPower:SBOundary:LIST:MS:APPend
30000, 0, QPH ? C7(0):Q overlaps C8(0):Q
```

State Saved

Saved in instrument state.

Range `symbol_rate = 7500 | 15000 | 30000 | 60000 | 120000 | 240000 | 480000 | 960000`

`0<= code_num <= 511 if symbol_rate = 7500`

`0<= code_num <= 255 if symbol_rate = 15000`

`0<= code_num <= 127 if symbol_rate = 30000`

`0<= code_num <= 63 if symbol_rate = 60000`

`0<= code_num <= 31 if symbol_rate = 120000`

`0<= code_num <= 15 if symbol_rate = 240000`

`0<= code_num <= 7 if symbol_rate = 480000`

`0<= code_num <= 3 if symbol_rate = 960000`

QAM16 for the 3rd parameter is available only for channels with symbol rate 240000. For other channels, specify QPSK.

Key Path **no support (SCPI only)**

Code Domain - Symbol Boundary Custom Active Channel List BTS Append [BTS only]

```
[ :SENSe ] :CDPower:SBOundary:LIST [ :BTS ] :APPend  
<symbol_rate>, <code_num>, QPSK|QAM16
```

This command appends the entry on the list of custom active channel list for BTS.

1st parameter:

`<symbol_rate>` This parameter specifies symbol rate of the channel.

2nd parameter:

`<code_num>` This parameter specifies code number of the channel.

3rd parameter:

QPSK Specifies the channel's modulation scheme is QPSK.

QAM16 Specifies the channel's modulation scheme is QAM16.
This choice is available only for channels with symbol rate 240000.

Example In order to predefine the following channels:

- CPICH (C8(0))
- P-CCPCH (C8(1))
- S-CCPCH(C8(3))
- PICH(C8(16))
- HS-PDSCH (C4(15)) 16QAM modulated

```

:SENSe:CDPower:SBOundary:LIST:BTS:INIT
15000,0, QPSK
:SENSe:CDPower:SBOundary:LIST:BTS:APPend
15000,1, QPSK
:SENSe:CDPower:SBOundary:LIST:BTS:APPend
15000,3, QPSK
:SENSe:CDPower:SBOundary:LIST:BTS:APPend
15000,16, QPSK
:SENSe:CDPower:SBOundary:LIST:BTS:APPend
240000,15, QAM16

:SENSe:CDPower:SBOundary:LIST:BTS:NCHan
nels?
5

:SENSe:CDPower:SBOundary:LIST:BTS:CHANn
el? 1
15000,0, QPSK
:SENSe:CDPower:SBOundary:LIST:BTS:CHANn
el? 2
15000,1, QPSK
:SENSe:CDPower:SBOundary:LIST:BTS:CHANn
el? 3
15000,3, QPSK
:SENSe:CDPower:SBOundary:LIST:BTS:CHANn
el? 4
15000,16, QPSK
:SENSe:CDPower:SBOundary:LIST:BTS:CHANn
el? 5
240000,15, QAM16

```

Notes

- (1) This command is effective when
[:SENSe]:RADio:DEVIce is set to BTS and
[:SENSe]:CDPower:SBOundary[:BTS] is set to
CUSTom.
- (2) QAM16 for the 4th parameter is available only
if HSDPA/HSUPA Enable is On.
- (3) The maximum number of entries is 512.

Remote Command
Notes

One of the following error messages will be logged if the given parameter is invalid.

If error is reported, the SCPI command is rejected and instrument's settings does not change.

(1) "Missing Parameter" (PSA: -109, E4406A VSA: -109)

This error is reported if the number of parameters is less than 3.

For example:

```
:SENSe:CDPower:SBOundary:LIST:MS:INIT
15000, 0 ? 3rd parameter is missing.
```

(2) "Illegal parameter value" (PSA: -224, E4406A VSA: -224) This error is reported if parameter type is invalid or if enum value is invalid.

For example:

```
:SENSe:CDPower:SBOundary:LIST:MS:INIT
15000, ON, QPH ? 2nd parameter must be
integer.
```

```
:SENSe:CDPower:SBOundary:LIST:MS:INIT
15001, 0, QPH ? 1st parameter value (Symbol
Rate) is not allowed.
```

Only the values given in Range field are valid for the Symbol Rate. You may specify these in numeric form, but they are interpreted as an enumeration and the error will result if the value does not translate to one in the list.

(3) "Data out of range" (PSA: -222, E4406A VSA: -222) This error is reported if parameter value is out of range.

For example:

```
:SENSe:CDPower:SBOundary:LIST:MS:INIT
15000, 256, QPH ? 2nd parameter is out of range.
```

(4) "Setting Conflict" (PSA: -221, E4406A VSA: -221) This error is reported if the given code channel overlaps other code channel on code domain.

For example: If a user sends the following two commands, the second command causes the error message because C7(0):Q overlaps C8(0):Q.

```
:SENSe:CDPower:SBOundary:LIST:MS:INIT
15000, 0, QPH ? OK
```

```
:SENSe:CDPower:SBOundary:LIST:MS:APPend
30000, 0, QPH ? C7(0):Q overlaps C8(0):Q
```

State Saved

Saved in instrument state.

Range symbol_rate = 7500 | 15000 | 30000 | 60000 |
120000 | 240000 | 480000 | 960000

0<= code_num <= 511 if symbol_rate = 7500

0<= code_num <= 255 if symbol_rate = 15000

0<= code_num <= 127 if symbol_rate = 30000

0<= code_num <= 63 if symbol_rate = 60000

0<= code_num <= 31 if symbol_rate = 120000

0<= code_num <= 15 if symbol_rate = 240000

0<= code_num <= 7 if symbol_rate = 480000

0<= code_num <= 3 if symbol_rate = 960000

QAM16 for the 3rd parameter is available only for channels with symbol rate 240000. For other channels, specify QPSK.

Key Path **no support (SCPI only)**

Code Domain - Symbol Boundary Custom Active Channel List BTS Relace [BTS only]

```
[[:SENSe]:CDPower:SBOundary:LIST[:BTS]:REPLace <entry_id>,  
<symbol_rate>, <code_num>, QPSK|QAM16
```

This command replaces the entry of the custom active channel list for BTS.

1st parameter:

<entry_id> This parameter specifies entry ID of the channel to replace.

2nd parameter:

<symbol_rate> This parameter specifies symbol rate of the channel.

3rd parameter:

<code_num> This parameter specifies code number of the channel.

4th parameter:

- QPSK Specifies the channel's modulation scheme is QPSK.
- QAM16 Specifies the channel's modulation scheme is QAM16.
This choice is available only for channels with symbol rate 240000.

Example In order to predefine the following channels:

- CPICH (C8(0))
- P-CCPCH (C8(1))
- S-CCPCH(C8(3))
- PICH(C8(16))
- HS-PDSCH (C4(15)) 16QAM modulated

```
:SENSe:CDPower:SBOundary:LIST:BTS:INIT
15000,0, QPSK
:SENSe:CDPower:SBOundary:LIST:BTS:APPend
15000,1, QPSK
:SENSe:CDPower:SBOundary:LIST:BTS:APPend
15000,3, QPSK
:SENSe:CDPower:SBOundary:LIST:BTS:APPend
15000,16, QPSK
:SENSe:CDPower:SBOundary:LIST:BTS:APPend
240000,15, QAM16
```

And, P-CCPCH(C8(3)) is replaced as following.

```
:SENSe:CDPower:SBOundary:LIST:BTS:REPLAc
e 3,15000,5,QPSK

:SENSe:CDPower:SBOundary:LIST:BTS:NCHan
nels?
5

:SENSe:CDPower:SBOundary:LIST:BTS:CHANn
el? 1
15000,0, QPSK
:SENSe:CDPower:SBOundary:LIST:BTS:CHANn
el? 2
15000,1, QPSK
:SENSe:CDPower:SBOundary:LIST:BTS:CHANn
el? 3
15000,5, QPSK
:SENSe:CDPower:SBOundary:LIST:BTS:CHANn
el? 4
15000,16, QPSK
:SENSe:CDPower:SBOundary:LIST:BTS:CHANn
el? 5
240000,15, QAM16
```

Notes

- (1) This command is effective when
[:SENSe]:RADio:DEVIce is set to BTS and
[:SENSe]:CDPower:SBOundary[:BTS] is set to
CUSTom.
- (2) QAM16 for the 4th parameter is available only
if HSDPA/HSUPA Enable is On.
- (3) The maximum number of entries is 512.

Remote Command
Notes

One of the following error messages will be logged if the given parameter is invalid.

If error is reported, the SCPI command is rejected and instrument's settings does not change.

(1) "Missing Parameter" (PSA: -109, E4406A VSA: -109)

This error is reported if the number of parameters is less than 3.

For example:

```
:SENSe:CDPower:SBOundary:LIST:MS:INIT
15000, 0 ? 3rd parameter is missing.
```

(2) "Illegal parameter value" (PSA: -224, E4406A VSA: -224) This error is reported if parameter type is invalid or if enum value is invalid.

For example:

```
:SENSe:CDPower:SBOundary:LIST:MS:INIT
15000, ON, QPH ? 2nd parameter must be integer.
:SENSe:CDPower:SBOundary:LIST:MS:INIT
15001, 0, QPH ? 1st parameter value (Symbol
Rate) is not allowed.
```

Only the values given in Range field are valid for the Symbol Rate. You may specify these in numeric form, but they are interpreted as an enumeration and the error will result if the value does not translate to one in the list.

(3) "Data out of range" (PSA: -222, E4406A VSA: -222) This error is reported if parameter value is out of range.

For example:

```
:SENSe:CDPower:SBOundary:LIST:MS:INIT
15000, 256, QPH ? 2nd parameter is out of range.
```

(4) "Setting Conflict" (PSA: -221, E4406A VSA: -221) This error is reported if the given code channel overlaps other code channel on code domain.

For example: If a user sends the following two commands, the second command causes the error message because C7(0):Q overlaps C8(0):Q.

```
:SENSe:CDPower:SBOundary:LIST:MS:INIT
15000, 0, QPH ? OK
```

```
:SENSe:CDPower:SBOundary:LIST:MS:APPend
30000, 0, QPH ? C7(0):Q overlaps C8(0):Q
```

State Saved

Saved in instrument state.

Range	<p>The entry ID must be:</p> <p>1 <= entry_id <= The number of entries which have been defined. (See REF_Ref123466940 \r \h - Symbol Boundary Custom Active Channel List – The Number Of Entries BTS [BTS only])</p> <p>symbol_rate = 7500 15000 30000 60000 120000 240000 480000 960000</p> <p>0<= code_num <= 511 if symbol_rate = 7500 0<= code_num <= 255 if symbol_rate = 15000 0<= code_num <= 127 if symbol_rate = 30000 0<= code_num <= 63 if symbol_rate = 60000 0<= code_num <= 31 if symbol_rate = 120000 0<= code_num <= 15 if symbol_rate = 240000 0<= code_num <= 7 if symbol_rate = 480000 0<= code_num <= 3 if symbol_rate = 960000</p> <p>QAM16 for the 4th parameter is available only for channels with symbol rate 240000. For other channels, specify QPSK.</p>
Key Path	no support (SCPI only)

Code Domain - Symbol Boundary Custom Active Channel List BTS Query [BTS only]

[[:SENSe]:CDPower:SBOundary:LIST[:BTS]:CHANnel? <entry_id>

This command returns the entry of the custom active channel list for BTS.

1st parameter:

<entry_id> This parameter specifies entry ID of the channel to query.

Example

In order to predefine the following channels:

- CPICH (C8(0))
- P-CCPCH (C8(1))
- S-CCPCH(C8(3))
- PICH(C8(16))
- HS-PDSCH (C4(15)) 16QAM modulated

```
:SENSe:CDPower:SBOundary:LIST:BTS:INIT
15000,0, QPSK
:SENSe:CDPower:SBOundary:LIST:BTS:APPend
15000,1, QPSK
:SENSe:CDPower:SBOundary:LIST:BTS:APPend
15000,3, QPSK
:SENSe:CDPower:SBOundary:LIST:BTS:APPend
15000,16, QPSK
:SENSe:CDPower:SBOundary:LIST:BTS:APPend
240000,15, QAM16
```

```
:SENSe:CDPower:SBOundary:LIST:BTS:NCHan
nels?
5
```

```
:SENSe:CDPower:SBOundary:LIST:BTS:CHANn
el? 1
15000,0, QPSK
:SENSe:CDPower:SBOundary:LIST:BTS:CHANn
el? 2
15000,1, QPSK
:SENSe:CDPower:SBOundary:LIST:BTS:CHANn
el? 3
15000,3, QPSK
:SENSe:CDPower:SBOundary:LIST:BTS:CHANn
el? 4
15000,16, QPSK
:SENSe:CDPower:SBOundary:LIST:BTS:CHANn
el? 5
240000,15, QAM16
```

Notes

- (1) This command is effective when [:SENSe]:RADio:DEVice is set to BTS and [:SENSe]:CDPower:SBOundary[:BTS] is set to CUSTom.
- (2) QAM16 for the 4th parameter is available only if HSDPA/HSUPA Enable is On.
- (3) The maximum number of entries is 512.

Remote Command	Default value of the parameter
Notes	<p>By default, there is one channel defined. (CPICH C8(0)) In order to query the default entry, specify 1 for <entry_id>: :SENSe:CDPower:SBOundary:LIST:BTS:CHANnel? 1 The instrument will return an array of three values: 15000, 0, QPSK</p> <p>Query command needs <entry_id> parameter</p> <p><entry_id> parameter is always required for query command. The range of the parameter is from 1 to the total number of channels you have defined. For example, if you have defined two channels, you can query them as follows: :SENSe:CDPower:SBOundary:LIST:BTS:CHANnel? 1 :SENSe:CDPower:SBOundary:LIST:BTS:CHANnel? 2</p> <p>If you want to know the number of channels you have defined, send the following query command: :SENSe:CDPower:SBOundary:LIST:BTS:NChannels?</p>
Preset	15000, 0, QPSK
State Saved	Saved in instrument state.
Range	<p>The entry ID must be:</p> <p>1 <= entry_id <= The number of entries which have been defined. (See - Symbol Boundary Custom Active Channel List – The Number Of Entries BTS [BTS only])</p>
Key Path	no support (SCPI only)

Code Domain - Symbol Boundary Custom Active Channel List BTS Load Preset Setting [BTS only]

```
[ :SENSe] :CDPower :SBOundary :LIST [ :BTS] :PRESet
TM1D16 | TM1D32 | TM1D64 | TM1D16SC | TM1D32SC | TM1D64SC | TM2 | TM2SC | T
M3D16 | TM3D32 | TM3D16SC | TM3D32SC | TM4 | TM4CP | TM5H2 | TM5H4 | TM5H8
```

This command-only command loads preset setting to the custom active channel list BTS.

Example	:SENSe:CDPower:SBOundary:LIST:BTS:PRESet TM1D64
Notes	(1) This command is effective when [:SENSe]:RADio:DEVice is set to BTS and [:SENSe]:CDPower:SBOundary[:BTS] is set to CUSTom. (2) TM5H2, TM5H4, TM5H8 parameters are allowed if HSDPA/HSUPA Enable is On.
Remote Command Notes	This command is a command-only command.
State Saved	No
Range	TM1D16 TM1D32 TM1D64 TM1D16SC TM1 D32SC TM1D64SC TM2 TM2SC TM3D16 TM3D32 TM3D16SC T M3D32SC TM4 TM4CP TM5H2 TM5H4 TM5H8 The meaning of above parameters are the same as those of Predefined Test Model provided in Slot Boundary Test Model in BTS.
Key Path	no support (SCPI only)

Code Domain - Symbol Boundary MS [MS only]

Select the symbol boundary detection mode for MS.

Allows you to access the selection menu for the symbol boundary detection modes to specify active channel detection scheme on uplink.

Auto [SCPI Enum: AUTO] – Select this to set the symbol boundary detection to the automatic mode. Various code channels are measured and the most appropriate code channel is selected as the reference channel.

Custom [SCPI Enum: CUSTom] – “Custom” choice provides a flexible way to specify predefined active channels. By choosing it, you can specify a customized list of active channels by another SCPI command:

```
[[:SENSe]:CDPower:SBOundary:LIST:MS INIT|APPend|<entry_id>,  
<symbol_rate>, <code_num>, IPH|QPH
```

(See Symbol Boundary Custom Active Channel List MS for the command.)

All the specified channels are considered as active.

There is no MUI (softkey) to specify custom active channel list.

NOTE

The “Custom” choice is selectable even if you have not sent the following SCPI command:

```
“[:SENSe]:CDPower:SBOundary:LIST:MS”
```

because the default custom list contains DPCCH (15000, 0, QPH) as a predefined active channel. In other words, just simply choosing “Custom” setting will make one channel (C8(0):Q) considered as active, and all other channels considered as inactive.

Example	:SENSe:CDPower:SBOundary:MS CUST
Notes	This parameter is effective when [:SENSe]:RADio:DEvice is set to MS.
Dependencies and Couplings	<p>This softkey is active if “Radio Device” selection is “MS” AND “Capture Intvl” is one of “1 slot”, “3 slot”, “1 frame”, “2 frame” and “3 frame”.</p> <p>This softkey is inactive (grayed out) if “Radio Device” selection is “MS” AND “Capture Intvl” is either “4 frame” or “8 frame” or “16 frame”.</p> <p>If “Radio Device” selection is “BTS”, different softkey (Symbol Boundary BTS) appears instead of this softkey.</p>
Preset	AUTO
State Saved	Saved in instrument state.
Range	Auto Custom
Key Path	Meas Setup, More

Code Domain - Symbol Boundary Custom Active Channel List – Load Preset Setting BTS [BTS only]

```
[ :SENSe] :CDPower:SBOundary [:BTS]
AUTO | TM1D16 | TM1D32 | TM1D64 | TM1D16SC | TM1D32SC | TM1D64SC | TM2 | TM
2SC | TM3D16 | TM3D32 | TM3D16SC | TM3D32SC | TM4 | TM4CP |
TM5H2 | TM5H4 | TM5H8 | CUSTom
```

```
[ :SENSe] :CDPower:SBOundary [:BTS] ?
```

This command-only command loads preset setting to the custom active channel list BTS.

Example	:SENSe:CDPower:SBOundary:BTS TM1D16
Notes	This parameter is effective when [:SENSe]:RADio:DEvice is set to BTS.

Dependencies and
Couplings

This softkey is active if “Radio Device” selection is “BTS” AND “Capture Intvl” is one of “1 slot”, “3 slot”, “1 frame”, “2 frame” and “3 frame”.

This softkey is inactive (grayed out) if “Radio Device” selection is “BTS” AND “Capture Intvl” is either “4 frame” or “8 frame” or “16 frame”.

If “Radio Device” selection is “MS”, a different softkey (Symbol Boundary MS) appears instead of this softkey.

Remote Command
Notes

The reason that TM5H2, TM5H4 and TM5H8 have been selected is to align the enumerations with those of ESG’s. W-CDMA HSDPA option license is necessary to make these three parameters for test model 5 available. In addition, you need to enable W-CDMA HSDPA option functionality. Otherwise, this parameter is not available --- Test Model 5 softkey is inactive (grayed out) and SCPI commands for Test Model 5 do not have effect.

Preset

AUTO

State Saved

Saved in instrument state.

Range

Auto |
Test Model 1 w/ 16 DPCH w/ S_CCPCH |
Test Model 1 w/ 32 DPCH w/ S_CCPCH |
Test Model 1 w/ 64 DPCH w/ S_CCPCH |
Test Model 1 w/ 16 DPCH |
Test Model 1 w/ 32 DPCH |
Test Model 1 w/ 64 DPCH |
Test Model 2 w/ S_CCPCH |
Test Model 2 |
Test Model 3 w/ 16 DPCH w/ S_CCPCH |
Test Model 3 w/ 32 DPCH w/ S_CCPCH |
Test Model 3 w/ 16 DPCH |
Test Model 3 w/ 32 DPCH |
Test Model 4 w/ P-CPICH |
Test Model 4 |
Test Model 5 w/ 2 HS-PDSCH w/ 6 DPCH |
Test Model 5 w/ 4 HS-PDSCH w/ 14 DPCH |
Test Model 5 w/ 8 HS-PDSCH w/ 30 DPCH |
Custom

Key Path

Meas Setup, More

Code Domain - Symbol Boundary BTS [BTS only]

Allows you to access the selection menu for the symbol boundary detection modes to specify active channel detection scheme on downlink.

Auto [SCPI Enum: AUTO] - Select this to set the symbol boundary detection to the automatic mode. Various code channels are measured and the most appropriate code channel is selected as the reference channel.

Pressing “Auto” softkey closes this sub menu and gets back to its parent menu (Meas Setup 2 of 2)

Pre-Defined Test Models - Allows you to access selection menus for the test models as specified in 3GPP TS.25.141.

Lower level menus allow further selection of various numbers of DPCH channels to be active.

Test Model 1 - Press this key to access a menu to allow further selections of Test Model 1 with 16, 32 or 64 DPCH channels, and to select a Test Model with or without S-CCPCH.

Test Model 1 w/16 DPCH w/ S-CCPCH [SCPI Enum: TM1D16] - Select this to set the Code Domain Power measurement to the Test Model 1 with 16 DPCH channels and 1 S-CCPCH channel.

Test Model 1 w/32 DPCH w/ S-CCPCH [SCPI Enum: TM1D32] - Select this to set the Code Domain Power measurement to Test Model 1 with 32 DPCH channels and 1 S-CCPCH channel.

Test Model 1 w/64 DPCH w/ S-CCPCH [SCPI Enum: TM1D64] - Select this to set the Code Domain Power measurement to Test Model 1 with 64 DPCH channels and 1 S-CCPCH channel.

Test Model 1 w/16 DPCH [SCPI Enum: TM1D16SC] - Select this to set the Code Domain Power measurement to the Test Model 1 with 16 DPCH channels (no S-CCPCH channel).

Test Model 1 w/32 DPCH [SCPI Enum: TM1D32SC] - Select this to set the Code Domain Power measurement to Test Model 1 with 32 DPCH channels (no S-CCPCH channel).

Test Model 1 w/64 DPCH [SCPI Enum: TM1D64SC] - Select this to set the Code Domain Power measurement to Test Model 1 with 64 DPCH channels (no S-CCPCH channel).

Test Model 2 - Press this key to access a menu to allow selections of Test Model 2, with or without S-CCPCH.

Test Model 2 w/S-CCPCH [SCPI Enum: TM2SC] - Select this to set the Code Domain Power measurement to Test Model 2 with 1 S-CCPCH channel.

Test Model 2 [SCPI Enum: TM2] - Select this to set the Code Domain Power measurement to Test Model 2 (no S-CCPCH channel).

Test Model 3 - Press this key to access a menu to allow further selections from Test Model 3 with 16 or 32 DPCH channels, and to select a Test Model with or without S-CCPCH.

Test Model 3 w/16 DPCH w/ S-CCPCH [SCPI Enum: TM3D16SC] - Select this to set the Code Domain Power measurement to Test Model 3 with 16 DPCH channels and 1 S-CCPCH channel.

Test Model 3 w/32 DPCH w/ S-CCPCH [SCPI Enum: TM3D32SC] - Select this to set the Code Domain Power measurement to Test Model 3 with 32 DPCH channels and 1 S-CCPCH channel.

Test Model 3 w/16 DPCH [SCPI Enum: TM3D16] - Select this to set the Code Domain Power measurement to Test Model 3 with 16 DPCH channels (no S-CCPCH channel).

Test Model 3 w/32 DPCH [SCPI Enum: TM3D32] - Select this to set the Code Domain Power measurement to Test Model 3 with 32 DPCH channels (no S-CCPCH channel).

Test Model 4 - Press this key to access a menu to allow further selections of Test Model 4.

Test Model 4 w/P-CPICH [SCPI Enum: TM4CP] - Select this to set the Code Domain Power measurement to Test Model 4 with 1 CPICH channel.

Test Model 4 [SCPI Enum: TM4] - Select this to set the Code Domain Power measurement to Test Model 4 (no CPICH channel).

Test Model 5 - Press this key to access a menu to allow further selections of Test Model 5. Should be grayed out if the 'HSDPA/HSUPA Enable' is 'Off'.

Test Model 5 w/2 HS-PDSCH w/6 DPCH [SCPI Enum: TM5H2] - Select this to set the Code Domain Power measurement to Test Model 5 with 2 HS-PDSCH channels and 6 DPCH channels.

Test Model 5 w/4 HS-PDSCH w/14 DPCH [SCPI Enum: TM5H4] - Select this to set the Code Domain Power measurement to Test Model 5 with 4 HS-PDSCH channels and 14 DPCH channels.

Test Model 5 w/8 HS-PDSCH w/30 DPCH [SCPI Enum: TM5H8] - Select this to set the Code Domain Power measurement to Test Model 5 with 8 HS-PDSCH channels and 30 DPCH channels.

NOTE The reason that the number of HS-PDSCH comes first then that of DPCH comes next: It is to emphasize “HS-PDSCH” and also to align with ESG’s front panel as much as possible. ESG displays the number of HS-PDSCH. (e.g. ESG’s softkey displays “Test Model 5 w/8HSPDSCH”) PSA and E4406A displays the number of DPCH in addition to the number of HS-PDSCH.

The followings are extracted from 3GPP specifications regarding Test Model definitions. Channelization code (Channel Code) and Spreading Factor (SF) information are used for Symbol Boundary.

Custom [SCPI Enum: CUSTom] – “Custom” choice provides a flexible way to specify predefined active channels. By choosing it, you can specify a customized list of active channels by another SCPI command.

```
[[:SENSe]:CDPower:SBOundary:LIST[:BTS]
INIT|APPend| <entry_id>, <symbol_rate>, <code_num>,
QPSK|QAM16
```

See for the command.

All the specified channels are considered as active.

There is no MUI (softkey) to specify custom active channel list.

NOTE The “Custom” choice is selectable even if you have not sent the following SCPI command:
“[:SENSe]:CDPower:SBOundary:LIST[:BTS]”
because the default custom list contains CPICH (15000, 0, QPSK) as a predefined active channel. In other words, just simply choosing “Custom” setting will make one channel (C8(0)) considered as active, and all other channels considered as inactive.

Pressing “Custom” softkey closes this sub menu and gets back to its parent menu (Meas Setup 2 of 2)

Table 6-1 Test Model 1 (2000–12 version)

Type	Number of Channels	Fraction of Power (%)	Level setting (dB)	Channelization Code	Timing offset (x256Tchip)
PCCPCH+SCH	1	10	–10	1	0
Primary CPICH	1	10	–10	0	0
PICH	1	3.2	–15	16	120
DPCH (SF=128)	16/32/64	76.8 in total	see table 6.2	see table 6.2	see table 6.2

Table 6-2 Test Model 1 (2002–09 version) (S-CCPCH included)

Type	Number of Channels	Fraction of Power (%)	Level setting (dB)	Channelization Code	Timing offset (x256Tchip)
P-CCPCH+SCH	1	10	-10	1	0
Primary CPICH	1	10	-10	0	0
PICH	1	1.6	-18	16	120
S-CCPCH containing PCH (SF=256)	1	1.6	-18	3	0
DPCH (SF=128)	16/32/64	76.8 in total	see table 6.2	see table 6.2	see table 6.2

Table 6-3 Test Model 2 (2000–12 version)

Type	Number of Channels	Fraction of Power (%)	Level setting (dB)	Channelization Code	Timing offset (x256Tchip)
PCCPCH+SCH	1	10	-10	1	0
Primary CPICH	1	10	-10	0	0
PICH	1	10	-10	16	120
DPCH (SF=128)	3	2 x 10, 1 x 50	2 x -10, 1 x -3	24, 72, 120	1, 7, 2

Table 6-4 Test Model 2 (2002–09 version) (S-CCPCH included)

Type	Number of Channels	Fraction of Power (%)	Level setting (dB)	Channelization Code	Timing offset (x256Tchip)
P-CCPCH+SCH	1	10	-10	1	0
Primary CPICH	1	10	-10	0	0
PICH	1	5	-13	16	120
S-CCPCH containing PCH (SF=256)	1	5	-13	3	0

Table 6-4 Test Model 2 (2002–09 version) (S-CCPCH included)

DPOCH (SF=128)	3	2 x 10, 1 x 50	2 x -10, 1 x -3	24, 72, 120	1, 7, 2
-------------------	---	-------------------	-----------------	----------------	------------

Table 6-5 Test Model 3 (2000–12 version)

Type	Number of Channels	Fraction of Power (%) 16/32	Level settings (dB) 16/32	Channelization Code	Timing offset (x256Tchip)
PCCPCH+SCH	1	12,6/7,9	-9 / -11	1	0
Primary CPICH	1	12,6/7,9	-9 / -11	0	0
PICH	1	10/3,2	-10 / -15	16	120
DPOCH (SF=256)	16/32	63,7/80,4 in total	see table 6.5	see table 6.5	see table 6.5

Table 6-6 Test Model 3 (2002–09 version) (S-CCPCH included)

Type	Number of Channels	Fraction of Power (%) 16/32	Level settings (dB) 16/32	Channelization Code	Timing offset (x256Tchip)
P-CCPCH+SCH	1	12,6/7,9	-9 / -11	1	0
Primary CPICH	1	12,6/7,9	-9 / -11	0	0
PICH	1	5/1.6	-13/-18	16	120
S-CCPCH containing PCH (SF=256)	1	5/1.6	-13/-18	3	0
DPOCH (SF=256)	16/32	63,7/80,4 in total	see table 6.5	see table 6.5	see table 6.5

Table 6-7 Test Model 4 Active Channels

Type	Number of Channels	Fraction of Power (%)	Level setting (dB)	Channelization Code	Timing offset
PCCPCH+SCH	1	50 to 1.6	-3 to -18	1	0
Primary CPICH1	1	10	-10	0	0

Table 6-7 Test Model 4 Active Channels

Note 1: The CPICH channel is optional.

Table 6-8 Test Model 5 Active Channels (2000–12 version)

Type	Number of Channels	Fraction of Power (%)	Level setting (dB)	Channelization Code	Timing offset (x256Tchip)
P-CCPCH+SCH	1	7.9	-11	1	0
Primary CPICH	1	7.9	-11	0	0
PICH	1	1.3	-19	16	120
S-CCPCH containing PCH (SF=256)	1	1.3	-19	3	0
DPCH (SF=128)	30/14/6(*)	14/14.2/14.4 in total	see table 6.b	see table 6.b	see table 6.b
HS-SCCH	2	4 in total	see table 6.c	see table 6.c	see table 6.c
HS-PDSCH (16QAM)	8/4/2(*)	63.6/63.4/63.2 in total	see table 6.d	see table 6.d	see table 6.d

Note *: 2 HS-PDSCH shall be taken together with 6 DPCH, 4 HS-PDSCH shall be taken with 14 DPCH, and 8 HS-PDSCH shall be taken together with 30 DPCH.

Code Domain - Slot Format [MS only]

`[[:SENSe]:CDPower:SFFormat:MS SF0 | SF1 | SF2 | SF3 | SF4 | SF5 | AUTO`

`[[:SENSe]:CDPower:SFFormat:MS?`

Select Slot Format for synchronization to the uplink signal. This command is effective when the `[[:SENSe]:CDPower:SYNC:MS` command is set to `DPCCh`.

In the automatic synchronization process, the algorithm searches the best correlation of DPCC pilot pattern among slot format 0, 1, 2 and 3. (The reason the algorithm doesn't search slot format 4 and 5 is that 3GPP standard release 6 no longer defines slot format 4 and 5.)

If signal in slot format 4 is given, the auto-sync algorithm considers it as slot format 0.

If signal in slot format 5 is given, the auto-sync algorithm considers it as slot format 2.

Manual setting of the slot format (SF0 to SF5) is also supported as previous.

SF0 – Slot Format 0

SF1 – Slot Format 1

SF2 – Slot Format 2

SF3 – Slot Format 3

SF4 – Slot Format 4

SF5 – Slot Format 5

Demod Bits attribute information is colored according to the detected or given Slot Format value. Using input parameter Slot Format#i, bit data is colored accordingly (e.g. Npilot, NTPC, NTFCI and NFBI).

Slot Format #i	Channel Bit Rate (kbps)	Channel Symbol Rate (ksps)	SF	Bits/ Frame	Bits/ Slot	Npilot	NTPC	NTFCI	NFBI	Transmitted slots per radio frame
0	15	15	256	150	10	6	2	2	0	15
0A	15	15	256	150	10	5	2	3	0	10–14
0B	15	15	256	150	10	4	2	4	0	8–9
1	15	15	256	150	10	8	2	0	0	8–15
2	15	15	256	150	10	5	2	2	1	15
2A	15	15	256	150	10	4	2	3	1	10–14
2B	15	15	256	150	10	3	2	4	1	8–9
3	15	15	256	150	10	7	2	0	1	8–15
4	15	15	256	150	10	6	2	0	2	8–15
5	15	15	256	150	10	5	1	2	2	15
5A	15	15	256	150	10	4	1	3	2	10–14
5B	15	15	256	150	10	3	1	4	2	8–9

NOTE

0A, 0B, 2A, 2B, 5A and 5B are slot formats for uplink DPCCH compressed frame. They are unavailable as the uplink slot format parameter.

Example	:SENSe:CDPower:SFORmat:MS SF1
Notes	This command is effective when [:SENSe]:RADio:DEVice is set to MS, and [:SENSe]:CDPower:SYNC:MS is set to DPCCh.
Dependencies and Couplings	See Restriction and Notes
Preset	SF0
State Saved	Saved in instrument state.
Range	SF0 SF1 SF2 SF3 SF4 SF5 Auto
Key Path	Meas Setup, More

Code Domain—Spectrum Normal/Invert

`[[:SENSe]:CDPower:SPECTrum INVert|NORMAl`

`[[:SENSe]:CDPower:SPECTrum?`

Set a spectrum either to normal or inverted for the demodulation related measurements. If set to INVert, the upper and lower spectrums are swapped.

Preset	NORMAl
State Saved	Saved in instrument state.
Range	Normal Invert
Key Path	Meas Setup, More, More

Remarks You must be in the cdmaOne, cdma2000, W-CDMA, or 1xEV-DO mode to use this command. Use INSTRument:SELEct to set the mode.

Code Domain - Sync Start

```
[ :SENSE ] :CDPower:SSLot:NUMBER <integer>
```

```
[ :SENSE ] :CDPower:SSLot:NUMBER?
```

```
[ :SENSE ] :CDPower:SSLot [:STATE] OFF | ON | 0 | 1
```

```
[ :SENSE ] :CDPower:SSLot [:STATE] ?
```

You can use any trigger (including Free Run) by enabling “Sync Start Slot” parameter “On” and specifying the slot number to measure as the first slot to get the measurement result beginning with the specified slot number.

- Sync Start Slot state is set to On the synchronization always starts from slot number 0.0 to 15.0 regardless of the trigger type:
- If Sync Start Slot state is set to Off, the measurement performs synchronization at any slot found right after the trigger timing.

Example	:SENSE:CDPower:SSLot:NUMBER 5 :SENSE:CDPower:SSLot:STATE ON
Notes	The softkey is grayed out if device is MS and Sync Type is PRACH Message.
Remote Command Notes	Turn first slot number detection mode on or off.
Preset	0, OFF
State Saved	Saved in instrument state.
Range	0 to 14
Key Path	Meas Setup, More, More
Active Function Text	Sync Start Slot

Code Domain - Sync Type (BTS)

```
[ :SENSe ] :CDPower:SYNC [ :BTS ]
CPICH | SCH | SYMBol | A2CPich | A1Sch | A2Sch
```

```
[ :SENSe ] :CDPower:SYNC [ :BTS ] ?
```

- CPICH - Allows you to synchronize with the CPICH channel.
- SCH - Allows you to synchronize with the SCH channel.
- Symbol Based - Allows you to access the menu for the code symbol synchronization.
- Symbol Rate - Allows you to set the symbol rate ranging from 7.5 to 960 ksps. The parameter automatically sets the maximum value for Code Number when appropriate.
- Code Number - Allows you to set the code number. The range is 0 to 511 depending on the Symbol Rate setting.
- Antenna-2 CPICH - Allows you to synchronize with the STTD Antenna-2 common pilot channel.
- Antenna-1 TSTD SCH – Allows you to synchronize with the TSTD SCH Antenna-1
- Antenna-2 TSTD SCH – Allows you to synchronize with the TSTD SCH Antenna-2

Notes	This command is effective when [:SENSe]:RADio:DEVIce is set to BTS.
Dependencies and Couplings	SYMBol:synchronize to the code symbol specified by [:SENSe]:CDPower:SYNC:SYMBol:SRATe and the [:SENSe]:CDPower:SYNC:SYMBol:SPRead commands.
Preset	CPICH
State Saved	Saved in instrument state.
Range	CPICH SCH Symbol Based Antenna-2 CPICH Antenna-1 TSTD SCH Antenna-2 TSTD SCH
Key Path	Meas Setup, More

Code Domain—Sync Type (MS)

`[:SENSe] :CDPower:SYNC:MS DPCCh | PMESsage`

`[:SENSe] :CDPower:SYNC:MS?`

Select DPCCh or PMESsage for synchronization to uplink signal.

DPCCh - Synchronize to DPCCH and Slot Format which is specified by `[:SENSe] :CDPower:SFORmat:MS`

PMESsage - Synchronize to PRACH Message and Slot Format which is specified by `[:SENSe] :CDPower:SFORmat:MS`

Example	<code>:SENSe:CDPower:SYNC:MS DPCCh</code>
Notes	This command is effective when <code>[:SENSe] :RADio:DEVIce</code> is set to MS.
Dependencies and Couplings	See Restriction and Notes
Preset	DPCCh
State Saved	Saved in instrument state.
Range	DPCCH PRACH Message
Key Path	Meas Setup, More
Remarks:	You must be in the W-CDMA mode to use this command. Use <code>INSTRument:SElect</code> to set the mode. When the <code>[:SENSe] :RADio:DEVIce</code> is set to MS, dedicated physical control channel (DPCCH) is automatically set to the sync channel.

Code Domain - Primary Scramble Code (BTS)

```
[[:SENSe]:CDPower:SYNC:SCRamble[:BTS] <integer>
```

```
[[:SENSe]:CDPower:SYNC:SCRamble[:BTS] ?
```

Set the BTS primary scramble code for synchronization. The BTS scramble code number (Down Link) is determined by “Primary Scramble Code”, “Scramble Code Offset” and “Scramble Code Type”.

The following information is an excerpt from TS25.213 Section 5.2.2 Scramble Code.

A total of $218-1 = 262,143$ scrambling codes, numbered $0 \dots 262,142$ can be generated. However not all the scrambling codes are used. The scrambling codes are divided into 512 sets each of a primary scrambling code and 15 secondary scrambling codes.

The primary scrambling codes consist of scrambling codes $n=16\forall i$ where $i=0 \dots 511$. The i :th set of secondary scrambling codes consists of scrambling codes $16\forall i+k$, where $k=1 \dots 15$.

There is a one-to-one mapping between each primary scrambling code and 15 secondary scrambling codes in a set such that i :th primary scrambling code corresponds to i :th set of secondary scrambling codes.

Hence, according to the above, scrambling codes $k = 0, 1, \dots, 8191$ are used. Each of these codes are associated with a left alternative scrambling code and a right alternative scrambling code, that may be used for compressed frames. The left alternative scrambling code corresponding to scrambling code k is scrambling code number $k + 8192$, while the right alternative scrambling code corresponding to scrambling code k is scrambling code number $k + 16384$. The alternative scrambling codes can be used for compressed frames. In this case, the left alternative scrambling code is used if $n < SF/2$ and the right alternative scrambling code is used if $n \geq SF/2$, where $C_{ch,SF,n}$ is the channelisation code used for non-compressed frames. The usage of alternative scrambling code for compressed frames is signalled by higher layers for each physical channel respectively.

Primary Scramble Code corresponds to i ($i=0 \dots 511$), Scramble Code Offset corresponds to k ($k= 1 \dots 15$: Secondary Scramble Code, 0: Primary Scramble Code) and Scramble Code Type Left and Right correspond $+8192$ and $+16384$ offset respectively.

Notes	This command is effective when [[:SENSe]:RADio:DEVICE is set to BTS.
Preset	0
State Saved	Saved in instrument state.
Range	0 to 511

SCPI Resolution	1
Key Path	Meas Setup, More

Code Domain—Scramble Code Offset

`[:SENSe] :CDPower :SYNC :SCRamble [:BTS] :OFFSet <integer>`

`[:SENSe] :CDPower :SYNC :SCRamble [:BTS] :OFFSet?`

Set the BTS scramble code offset for synchronization.

Notes	This command is effective when [:SENSe]:RADio:DEVice is set to BTS.
Preset	0
State Saved	Saved in instrument state.
Range	0 to 15 (0 for the primary scramble code; 1 to 15 for the secondary scramble code)
SCPI Resolution	1
Key Path	Meas Setup, More
Remarks:	You must be in the W-CDMA mode to use this command. Use INSTRument:SElect to set the mode.

Code Domain—Sync Scramble Code Type Down Link

```
[ :SENSe ] :CDPower:SYNC:SCRamble [ :BTS ] :TYPE  
LEFT | RIGHT | STANdard
```

```
[ :SENSe ] :CDPower:SYNC:SCRamble [ :BTS ] :TYPE?
```

Set the BTS primary scramble code type for synchronization.

LEFT – the left alternative scrambling code whose number is the primary scramble code number + 8192 is used.

RIGHT – the right alternative scrambling code whose number is the primary scrambling code number + 16384 is used.

STANdard – the standard scrambling code whose number is the primary scrambling code number is used.

Notes	This command is effective when [:SENSe]:RADio:DEVice is set to BTS.
Preset	STANdard
State Saved	Saved in instrument state.
Range	Std Left Right
Key Path	Meas Setup, More
Remarks:	You must be in the W-CDMA mode to use this command. Use INSTRument:SElect to set the mode.

Code Domain—Scramble Code Up Link

```
[ :SENSe ] :CDPower:SYNC:SCRamble:MS <integer>
```

```
[ :SENSe ] :CDPower:SYNC:SCRamble:MS?
```

Set the MS scramble code for synchronization.

Notes	This command is effective when [:SENSe]:RADio:DEVice is set to MS. Min : 0 (0x0; 24 bits) Max: 16,777,215 (0xFFFFF; 24 bits) Default: 0x0
Preset	0
State Saved	Saved in instrument state.
SCPI Resolution	1

Preset	7500
State Saved	Saved in instrument state.
Range	7500 15000 30000 60000 120000 240000 480000 960000
Key Path	Meas Setup, More, Sync Type, Symbol Based
Front-panel Unit/Terminator Keys	sps ksps
Range:	7500, 15000, 30000, 60000, 120000, 240000, 480000, 960000
Remarks:	You must be in the W-CDMA mode to use this command. Use INSTRument:SElect to set the mode.

Code Domain—Trigger Source

```
[ :SENSe ] :CDPower:TRIGger:SOURce IMMEDIATE | IF |  
EXTernal[1] | EXTernal2 | RFBurst | FRAME
```

```
[ :SENSe ] :CDPower:TRIGger:SOURce?
```

Select one of the trigger sources used to control the data acquisitions.

EXTernal 1 – front-panel external trigger input

EXTernal 2 – rear-panel external trigger input

FRAME – internal frame trigger

IF – internal IF envelope (video) trigger

IMMEDIATE – the next data acquisition is immediately taken,
capturing the signal asynchronously (also called free run).

RFBurst – internal wideband RF burst envelope trigger that has
automatic level control for periodic burst signals.

Used to select the trigger source for the measurement.

MMEDIATE	The trigger occurs at the time the data is requested, completely asynchronous to the RF or IF signal. (also called free run)
IF	An internal IF envelope trigger. It triggers on an absolute threshold level of the signal passed by the IF.

EXTernal[1]	Activates the external 1 trigger input. Location of the BNC Connector is the Front panel. The external trigger must be a signal between 5 and +5 volts.
EXTernal2	Activates the external 2 trigger input. . Location of the BNC Connector is the Front panel. The external trigger must be a signal between 5 and +5 volts.
KEY:RF Burst SCPI:RFBurst	An internal wideband RF burst trigger that has an automatic level control for burst signals. It triggers on a level that is relative to the peak of the signal passed by the RF or absolute level.
KEY:Frame SCPI:FRAME	Uses the internal periodic timer (used to called 'frame clock') to generate a trigger signal.
Preset	IMMEDIATE
State Saved	Saved in instrument state.
Range	Free Run (Immediate) Video (IF Envp) RF Burst Ext Front Ext Rear Frame
Key Path	Meas Setup, More, More
Remarks:	You must be in the cdma2000, W-CDMA, or 1xEV-DO mode to use this command. Use INSTRument:SElect to set the mode.

Channel Power Measurement

Commands for querying the channel power measurement results and for setting to the default values are found in the “[MEASure Group of Commands](#)” on page 654. The equivalent front-panel keys for the parameters described in the following commands, are found under the **Meas Setup** key, after the **Channel Power** measurement has been selected from the **MEASURE** key menu.

Channel Power—Average Count

```
[ :SENSe ] :CHPower:AVERAge:COUNT <integer>
```

```
[ :SENSe ] :CHPower:AVERAge:COUNT?
```

Set the number of data acquisitions that will be averaged. After the specified number of average counts, the averaging mode (terminal control) setting determines the averaging action.

Factory Preset: 20

200, for W-CDMA

Range: 1 to 10,000

Remarks: For PSA you must be in the cdmaOne, cdma2000, W-CDMA, or 1xEV-DO mode to use this command. Use INSTRument:SElect to set the mode.

For E4406A you must be in the Basic, cdmaOne, cdma2000, W-CDMA, or 1xEV-DO mode to use this command. Use INSTRument:SElect to set the mode.

Channel Power—Averaging State

```
[ :SENSe ] :CHPower:AVERAge [:STATe] OFF | ON | 0 | 1
```

```
[ :SENSe ] :CHPower:AVERAge [:STATe] ?
```

Turn averaging on or off.

Factory Preset: ON

Remarks: For PSA you must be in the cdmaOne, cdma2000, W-CDMA, or 1xEV-DO mode to use this command. Use INSTRument:SElect to set the mode.

For E4406A you must be in the Basic, cdmaOne, cdma2000, W-CDMA, or 1xEV-DO mode to use this command. Use INSTRument:SElect to set the mode.

Channel Power—Averaging Termination Control

```
[ :SENSe ] :CHPower:AVERage:TCONtrol EXPonential | REPEAT  
[ :SENSe ] :CHPower:AVERage:TCONtrol?
```

Select the type of termination control used for the averaging function. This determines the averaging action after the specified number of data acquisitions (average count) is reached.

EXPonential - Each successive data acquisition after the average count is reached, is exponentially weighted and combined with the existing average.

REPEAT - After reaching the average count, the averaging is reset and a new average is started.

Factory Preset: REPEAT

Remarks: For PSA you must be in the cdmaOne, cdma2000, W-CDMA, or 1xEV-DO mode to use this command. Use INSTRUMENT:SElect to set the mode.

For E4406A you must be in the Basic, cdmaOne, cdma2000, W-CDMA, or 1xEV-DO mode to use this command. Use INSTRUMENT:SElect to set the mode.

Channel Power—Integration BW

```
[ :SENSe ] :CHPower:BANDwidth | BWIDth:INTEgration <freq>  
[ :SENSe ] :CHPower:BANDwidth | BWIDth:INTEgration?
```

Set the Integration BW (IBW) that will be used.

Factory Preset: 1.23 MHz for Basic (E4406A), cdmaOne, cdma2000, 1xEV-DO

5.0 MHz for W-CDMA

Range: 1 kHz to 10 MHz

Default Unit: Hz

Remarks: For PSA you must be in the cdmaOne, cdma2000, W-CDMA, or 1xEV-DO mode to use this command. Use INSTRUMENT:SElect to set the mode.

For E4406A you must be in the Basic, cdmaOne, cdma2000, W-CDMA, or 1xEV-DO mode to use this command. Use INSTRUMENT:SElect to set the mode.

Channel Power—Span

`[:SENSE] :CHPower:FREQUENCY:SPAN <freq>`

`[:SENSE] :CHPower:FREQUENCY:SPAN?`

Set the frequency span that will be used.

Factory Preset: 2.0 MHz for Basic, cdmaOne, cdma2000, 1xEV-DO
6.0 MHz for W-CDMA

Range: Dependent on the current setting of the channel power integration bandwidth

Default Unit: Hz

Remarks: For PSA you must be in the cdmaOne, cdma2000, W-CDMA, or 1xEV-DO mode to use this command. Use INSTRUMENT:SElect to set the mode.

For E4406A you must be in the Basic, cdmaOne, cdma2000, W-CDMA, or 1xEV-DO mode to use this command. Use INSTRUMENT:SElect to set the mode.

Channel Power—Data Points

`[:SENSE] :CHPower:POINTs <integer>`

`[:SENSE] :CHPower:POINTs?`

Set the number of data points that will be used. Changing this will change the time record length and resolution BW that are used.

Factory Preset: 512

Range: 64 to 32768, in a 2ⁿ sequence

Remarks: For PSA you must be in the cdmaOne, cdma2000, W-CDMA, or 1xEV-DO mode to use this command. Use INSTRUMENT:SElect to set the mode.

For E4406A you must be in the Basic, cdmaOne, cdma2000, W-CDMA, or 1xEV-DO mode to use this command. Use INSTRUMENT:SElect to set the mode.

Channel Power—Data Points Auto

```
[ :SENSe ] :CHPower:POINTs:AUTO OFF|ON|0|1
```

```
[ :SENSe ] :CHPower:POINTs:AUTO?
```

Select auto or manual control of the data points. This is an advanced control that normally does not need to be changed. Setting this to a value other than the factory default, may cause invalid measurement results.

OFF - the Data Points is uncoupled from the Integration BW.

ON - couples the Data Points to the Integration BW.

Factory Preset: ON

Remarks: You must be in the Basic (E4406A), cdmaOne, cdma2000, W-CDMA, 1xEV-DO mode to use this command. Use INSTRument:SElect to set the mode.

Channel Power—Sweep Time

```
[ :SENSe ] :CHPower:SWEep:TIME <time>
```

```
[ :SENSe ] :CHPower:SWEep:TIME?
```

Sets the sweep time when using the sweep mode.

Factory Preset: 68.27 μ s

17.07 μ s for W-CDMA

Range: 1 μ s to 50 ms

Default Unit: seconds

Remarks: You must be in the Basic (E4406A), cdmaOne, cdma2000, W-CDMA, or 1xEV-DO mode to use this command. Use INSTRument:SElect to set the mode.

History: E4406A:
Version A.03.00 and later

Channel Power—Sweep Time

`[:SENSe] :CHPower :SWEep :TIME :AUTO OFF | ON | 0 | 1`

`[:SENSe] :CHPower :SWEep :TIME :AUTO?`

Selects the automatic sweep time, optimizing the measurement.

Factory Preset: ON

Remarks: You must be in the Basic (E4406A), cdmaOne, cdma2000, W-CDMA, or 1xEV-DO mode to use this command. Use INSTRument:SElect to set the mode.

History: E4406A:
Version A.03.00 and later

Channel Power—Trigger Source

`[:SENSe] :CHPower :TRIGger :SOURce
EXTernal [1] | EXTernal2 | IMMEDIATE`

`[:SENSe] :CHPower :TRIGger :SOURce?`

Select the trigger source used to control the data acquisitions. This is an Advanced control that normally does not need to be changed.

EXTernal 1 - front-panel external trigger input

EXTernal 2 - rear-panel external trigger input

IMMEDIATE - the next data acquisition is immediately taken (also called Free Run).

Factory Preset: IMMEDIATE

Remarks: For PSA you must be in the cdmaOne, cdma2000, W-CDMA, or 1xEV-DO mode to use this command. Use INSTRument:SElect to set the mode.

For E4406A you must be in the Basic, cdmaOne, cdma2000, W-CDMA, or 1xEV-DO mode to use this command. Use INSTRument:SElect to set the mode.

Signal Corrections Commands

Correction for BTS RF Port External Attenuation

```
[ :SENSE ] :CORRection:BTS[:RF]:LOSS <rel_power>
```

```
[ :SENSe ] :CORRection:BTS[:RF]:LOSS?
```

Set equal to the external attenuation used when measuring base transmission stations.

Factory Preset: 0.0 dB

Range: -50 to 100.0 dB for GSM, EDGE
 -100.0 to 100.0 dB for cdma2000, W-CDMA, 1xEV-DO

Default Unit: dB

Remarks: Global to the current mode.

You must be in the GSM, EDGE, cdma2000, W-CDMA, or 1xEV-DO mode to use this command. Use INSTRument:SElect to set the mode.

Correction for MS RF Port External Attenuation

```
[ :SENSE ] :CORRection:MS[:RF]:LOSS <rel_power>
```

```
[ :SENSe ] :CORRection:MS[:RF]:LOSS?
```

Set the correction equal to the external attenuation used when measuring mobile stations.

Factory Preset: 0.0 dB

Range: -50 to 100.0 dB for cdmaOne, GSM, EDGE, iDEN
 -100.0 to 100.0 dB for cdma2000, W-CDMA, 1xEV-DO
 -50.0 to 50.0 dB for NADC, PDC

Default Unit: dB

Remarks: For E4406A you must be in the cdmaOne, GSM, EDGE (w/GSM), cdma2000, W-CDMA, iDEN, NADC, PDC, or 1xEV-DO mode to use this command. Use INSTRument:SElect to set the mode.

For PSA you must be in the cdmaOne, GSM (w/EDGE), cdma2000, W-CDMA, NADC, PDC, or 1xEV-DO mode to use this command. Use INSTRument:SElect to set the mode.

Value is global to the current mode.

QPSK Error Vector Magnitude Measurement

Commands for querying the QPSK error vector magnitude measurement results and for setting to the default values are found in the “MEASure Group of Commands” on page 654. The equivalent front-panel keys for the parameters described in the following commands, are found under the **Meas Setup** key, after the **QPSK EVM** measurement has been selected from the **MEASURE** key menu.

QPSK Error Vector Magnitude — ADC Range

PSA and 14-bit ADC E4406A

```
[ :SENSe ] :EVMQpsk:ADC:RANGe
```

```
AUTO | APEak | APLock | NONE | P0 | P6 | P12 | P18
```

12-bit ADC E4406A

```
[ :SENSe ] :EVMQpsk:ADC:RANGe
```

```
AUTO | APEak | APLock | M6 | P0 | P6 | P12 | P18 | P24
```

```
[ :SENSe ] :EVMQpsk:ADC:RANGe?
```

Select a ranging function for the ADC gain control. This is an advanced control that normally does not need to be changed. If you are measuring a CW signal, see the following description:

- AUTO - automatic ranging

For FFT spectrums, the auto ranging should not be used. An exception to this would be if you know that your signal is “bursty”. Then you might use auto to maximize the time domain dynamic range as long as you are not very interested in the FFT data.

- APEak (Auto Peak) - automatic ranging to the peak signal level

For CW signals, the default of auto-peak ranging can be used, but a better FFT measurement of the signal can be made by selecting one of the manual ranges that is available by specifying M6, or P0 through P24.

Auto peaking can cause the ADC gain to monotonically track the ranges down during the data capture. This tracking effect should be negligible for the FFT spectrum, but selecting a manual range solves this possibility. Note that if the CW signal being measured is close to the auto-ranging threshold, the noise floor may shift as much as 6 dB every sweep.

- APLOCK (Auto Peak Lock) - automatic ranging locked to the peak signal level

For CW signals, auto-peak lock ranging may be used. It will find the ADC gain most appropriate for this particular signal and will not track the ranges as auto-peak can. Note that if the CW signal being measured is close to the auto-ranging threshold, the noise floor may shift as much as 6 dB every sweep.

For “bursty” signals, auto-peak lock ranging should not be used. Since the ADC range can often be locked to the wrong one resulting in overloading the ADC, the measurement will fail.

- NONE - (PSA) turns off any auto-ranging without making any changes to the current setting.
- M6 - (E4406A) manually selects an ADC range that subtracts 6 dB from the fixed gain across the range. Manual ranging is best for CW signals.
- P0 thru P18 - (PSA) manually selects one of the ADC ranges that add 0 dB to 24 dB to the fixed gain across the range. Manual ranging is best for CW signals.
- P0 thru P24 - (E4406A) manually selects one of the ADC ranges that add 0 dB to 24 dB to the fixed gain across the range. Manual ranging is best for CW signals.

Factory Preset: M6

Remarks: You must be in the 1xEV-DO mode to use this command. Use INSTRUMENT:SElect to set the mode.

History: PSA:
Added in version A.02.00
E4406A:
Added in version A.05.00

QPSK Error Vector Magnitude—Demod Alpha

```
[ :SENSe ] :EVMQpsk:ALPHA <numeric>
```

```
[ :SENSe ] :EVMQpsk:ALPHA?
```

Set alpha for the root Nyquist filter.

Factory Preset: 0.22

Range: 0.01 to 0.5

Remarks: You must be in the W-CDMA mode to use this command. Use INSTRUMENT:SElect to set the mode.

QPSK Error Vector Magnitude—Average Count

`[:SENSE] :EVMQpsk:AVERAge:COUNT <integer>`

`[:SENSE] :EVMQpsk:AVERAge:COUNT?`

Set the number of data acquisitions that will be averaged. After the specified number of average counts, the average mode (termination control) setting determines the average action.

Factory Preset: 10

Range: 1 to 10,000

Remarks: You must be in the cdma2000, W-CDMA, or 1xEV-DO mode to use this command. Use INSTRUMENT:SELEct to set the mode.

QPSK Error Vector Magnitude—Averaging State

`[:SENSE] :EVMQpsk:AVERAge [:STATe] OFF | ON | 0 | 1`

`[:SENSE] :EVMQpsk:AVERAge [:STATe] ?`

Turn the averaging function on or off.

Factory Preset: ON

Remarks: You must be in the cdma2000, W-CDMA, or 1xEV-DO mode to use this command. Use INSTRUMENT:SELEct to set the mode.

QPSK Error Vector Magnitude—Averaging Termination Control

`[:SENSE] :EVMQpsk:AVERAge:TCONtrol EXPOnential | REPEAT`

`[:SENSE] :EVMQpsk:AVERAge:TCONtrol?`

Select the type of termination control used to averaging. This determines the averaging action after the specified number of data acquisitions (average count) is reached.

EXPOnential – Each successive data acquisition after the average count is reached, is exponentially weighted and combined with the existing average.

REPEAT – After reaching the average count, the averaging is reset and a new average is started.

Factory Preset: REPEAT

Remarks: You must be in the cdma2000, W-CDMA, or 1xEV-DO mode to use this command. Use INSTRUMENT:SELEct to set the mode.

QPSK Error Vector Magnitude—Predefine Constellation Type

```
[ :SENSe ] :EVMQpsk:CONSt1n QPSK|RMC122
```

```
[ :SENSe ] :EVMQpsk:CONSt1n?
```

Select QPSK or RMC12.2k for the predefined constellation on MS. When Device is set to BTS, it is automatically set to QPSK.

QPSK: The reference points are set to QPSK constellation.

RMC122: The reference points are set to the RMC 12.2k constellation.

Factory Preset: QPSK

Remarks: You must be in the W-CDMA mode to use this command. Use INSTRument:SElect to set the mode.

QPSK Error Vector Magnitude—Chip Rate

```
[ :SENSe ] :EVMQpsk:CRATe <freq>
```

```
[ :SENSe ] :EVMQpsk:CRATe?
```

Enter a frequency value to set the chip rate.

Factory Preset: 1.2288 MHz for cdma2000, 1xEV-DO

3.84 MHz for W-CDMA

Range: 1.10592 to 1.35168 MHz for cdma2000, 1xEV-DO

3.456 to 4.224 MHz for W-CDMA

Default Unit: Hz

Remarks: You must be in the cdma2000, W-CDMA, or 1xEV-DO mode to use this command. Use INSTRument:SElect to set the mode.

QPSK Error Vector Magnitude—RF Carrier Mode

```
[ :SENSE ] :EVMQpsk:RFCarrier MULTiple | SINGle
```

```
[ :SENSE ] :EVMQpsk:RFCarrier?
```

Select either the single carrier mode or the multiple carrier mode.

MULTiple – The measurement assumes that the input signal is the multiple carriers with adjacent channel signals. The filter is used to cut the adjacent channel signals. (The filter may affect the measurement result.)

SINGle – The measurement assumes that the input signal is the single carrier without adjacent channel signals. No filter is used for better measurement.

Factory Preset: SINGle

Remarks: You must be in the cdma2000 or 1xEV-DO mode to use this command. Use INSTRUMENT:SELEct to set the mode.

QPSK Error Vector Magnitude— Spectrum Normal/Invert

```
[ :SENSE ] :EVMQpsk:SPECTrum INVert | NORMAl
```

```
[ :SENSE ] :EVMQpsk:SPECTrum?
```

Select inverted or normal spectrum for demodulation.

Factory Preset: NORMAl

Remarks: You must be in the W-CDMA mode to use this command. Use INSTRUMENT:SELEct to set the mode.

QPSK Error Vector Magnitude—Measurement Interval

`[:SENSe] :EVMQpsk :SWEep :POINts <integer>`

`[:SENSe] :EVMQpsk :SWEep :POINts?`

Set the number of data points that will be used as the measurement interval.

Factory Preset: 256 chips

96 chips for 1xEV-DO

2560 chips (1 slot) for W-CDMA

Range: 128 to 1536 chips for cdma2000

128 to 5120 chips for W-CDMA

32 to 2048 chips for 1xEV-DO

Remarks: You must be in the cdma2000, W-CDMA, or 1xEV-DO mode to use this command. Use `INSTRument:SElect` to set the mode.

QPSK Error Vector Magnitude—Trigger Source

`[:SENSe] :EVMQpsk :TRIGger :SOURce`

`EXTernal [1] | EXTernal2 | FRAMe | IF | IMMEDIATE`
`| RFBurst`

`[:SENSe] :EVMQpsk :TRIGger :SOURce?`

Select one of the trigger sources used to control the data acquisitions.

EXTernal 1 – front-panel external trigger input

EXTernal 2 – rear-panel external trigger input

FRAMe – internal frame trigger

IF – internal IF envelope (video) trigger

IMMEDIATE – the next data acquisition is immediately taken, capturing the signal asynchronously (also called free run)

RFBurst – wideband RF burst envelope trigger that has automatic level control for periodic burst signals

Factory Preset: IMMEDIATE

Remarks: You must be in the cdma2000, W-CDMA, or 1xEV-DO mode to use this command. Use `INSTRument:SElect` to set the mode.

RF Input Signal Alignments

Select the Input Signal

PSA:

```
[ :SENSe] :FEED RF | AREFERENCE | IFALIGN | WBALIGN
```

E4406A:

```
[ :SENSe] :FEED RF | IQ | IONLY | QONLY | AREFERENCE | IFALIGN
```

```
[ :SENSe] :FEED?
```

Selects the input signal. The default input signal is taken from the front-panel RF input port. For calibration and testing purposes the input signal can be taken from an internal 321.4 MHz IF alignment signal or an internal 50 MHz amplitude reference source.

For E4406A if the baseband IQ option (Option B7C) is installed, I and Q input ports are added to the front panel. The I and Q ports accept the in-phase and quadrature components of the IQ signal, respectively. The input signal can be taken from either or both ports.

RF selects the signal from the front-panel RF INPUT port.

IQ selects the combined signals from the front-panel optional I and Q input ports. (E4406A with Option B7C in Basic, W-CDMA, cdma2000, EDGE(w/GSM) modes)

IONLY selects the signal from the front-panel optional I input port. (E4406A with Option B7C in Basic mode)

QONLY selects the signal from the front-panel optional Q input port. (E4406A with Option B7C in Basic mode)

AREFERENCE selects the internal 50 MHz amplitude reference signal.

IFALIGN selects the internal, 321.4 MHz, IF alignment signal.

WBALIGN selects the internal IF alignment signal for the wide bandwidth hardware path.

(PSA with Option 122 in Basic mode)

Factory Preset: RF

Key Path: **Input, Input Port**

Remarks: To use this command for E4406A, the appropriate mode should be selected with INSTRUMENT:SELEct.

For PSA you must be in the Basic, cdmaOne, cdma2000, 1xEV-DO, W-CDMA, GSM, EDGE, NADC, or PDC mode to use this command. Use INSTRUMENT:SELEct to set the mode.

History: E4406A: modified in version A.05.00.
PSA modified in version A.06.00.

Clear Capture

[:SENSe] :FEED :SOURce :CLEar

Selecting “Clear Capture” UI clears internal memory of the instrument.

The data source indicator automatically changes back to “Input” for the next measurement.

NOTE

This parameter is command only. No query.

In order to use the data sharing function again, the user needs to select “Store Capture” again to store new raw data.

Example	:SENSe:FEED:SOURce:CLEar
Setup	:CONF:CDP :INIT:IMM :SENSe:FEED:SOURce:STORe
Dependencies and Couplings	Upon selecting this “Clear Capture” UI, “Data Source” setting automatically changes to “Input”.
State Saved	No
Key Path	Input (/Output), Data Source

Data Source

`[:SENSe] :FEED:SOURce INPut | STORed`

`[:SENSe] :FEED:SOURce?`

Data Source parameter specifies data source from which a measurement takes raw data.

Input : A measurement acquires an external signal via RF INPUT port.

Stored : A measurement copies raw data from data stored in instrument memory.

Example	<code>:SENSe:FEED:SOURce INPut</code>
Setup	<code>:CONF:CDP</code> <code>:INIT:IMM</code> <code>:SENSe:FEED:SOURce:STORe</code> <code>:SENSe:FEED:SOURce INPut</code>
Notes	If raw data doesn't exist on memory in the instrument, "Stored" choice is grayed out.
Dependencies and Couplings	Upon selecting this "Store Capture" UI, "Data Source" setting automatically changes to "Stored".
Preset	INPut
State Saved	Saved in instrument state.
Range	Input Stored
Key Path	Input

Store Capture

[:SENSe] :FEED :SOURce :STORe

Selecting “Store Capture” UI stores the current raw data in internal memory of the instrument.

This parameter is a command only. There is no query.

Example	:SENSe:FEED:SOURce:STORe
Setup	:CONF:CDP :INIT:IMM
Dependencies and Couplings	Upon selecting this “Store Capture” UI, “Data Source” setting automatically changes to “Stored”.
State Saved	No
Key Path	Input (/Output), Data Source

Frequency Commands

Center Frequency

`[:SENSe] :FREQUency:CENTer <freq>`

`[:SENSe] :FREQUency:CENTer?`

Set the center frequency.

Factory Preset: PSA

E4443A: 3.35 GHz for SA

E4445A: 6.5 GHz for SA

E4440A: 13.25 GHz for SA

1.0 GHz for Basic, cdmaOne, cdma2000, W-CDMA,
NADC, PDC modes

935.2 MHz for GSM, EDGE modes

Factory Preset: 1.0 GHz

942.6 MHz for GSM, EDGE

806.0 MHz for iDEN

Range: PSA

E4443A: 3 Hz to 6.7 GHz for SA

E4445A: 3 Hz to 13.2 GHz for SA

E4440A: 3 Hz to 26.5 GHz for SA

3 Hz to 1.5 GHz for Basic, cdmaOne, cdma2000,
W-CDMA, GSM, EDGE, NADC, PDC modes
(Measurement specifications are only applicable up
to 3 GHz.)

Range: 1.0 kHz to 4.3214 GHz

Default Unit: Hz

Key Path: **FREQUENCY/Channel, Center Freq**

Center Frequency Step Size Automatic

`[:SENSE] :FREQUENCY:CENTER:STEP:AUTO OFF | ON | 0 | 1`

`[:SENSE] :FREQUENCY:CENTER:STEP:AUTO?`

Specifies whether the step size is set automatically based on the span.

Factory Preset: ON

History: E4406A:
Version A.03.00 or later

Key Path: **FREQUENCY/Channel, CF Step**

Center Frequency Step Size

`[:SENSE] :FREQUENCY:CENTER:STEP [:INCRement] <freq>`

`[:SENSE] :FREQUENCY:CENTER:STEP [:INCRement] ?`

Specifies the center frequency step size.

Factory Preset: 5.0 MHz (E4406A)

1.25 MHz for cdma2000 (E4406A)

Range: 1.0 kHz to 1.0 GHz, in 10 kHz steps (E4406A)

Default Unit: Hz

History: E4406A:
Version A.03.00 or later

Key Path: **FREQUENCY/Channel, CF Step**

Intermodulation Measurement

Commands for querying the intermodulation measurement results and for setting to the default values are found in the “[MEASure Group of Commands](#)” on page 654. The equivalent front-panel keys for the parameters described in the following commands, are found under the **Meas Setup** key, after the **Intermod** measurement has been selected from the **MEASURE** key menu.

History: E4406A:
Added version A.04.00 and later

Intermodulation—Average Count

```
[ :SENSe ] : IM : AVERAge : COUNT <number>
```

```
[ :SENSe ] : IM : AVERAge : COUNT ?
```

Set the number of data acquisitions that will be averaged. After the specified number of average counts, the average mode (termination control) setting determines the average action.

Factory Preset: 10

Range: 1 to 10,000

Remarks: You must be in the cdma2000, W-CDMA, or 1xEV-DO mode to use this command. Use INSTRument:SElect to set the mode.

Intermodulation—Averaging State

```
[ :SENSe ] : IM : AVERAge [ :STATe ] OFF | ON | 0 | 1
```

```
[ :SENSe ] : IM : AVERAge [ :STATe ] ?
```

Turn the averaging function on or off.

Factory Preset: ON

Remarks: You must be in the cdma2000, W-CDMA, or 1xEV-DO mode to use this command. Use INSTRument:SElect to set the mode.

Intermodulation—Averaging Termination Control

```
[ :SENSE ] :IM:AVERAge:TCONtrol EXPonential | REPeat
```

```
[ :SENSE ] :IM:AVERAge:TCONtrol?
```

Select the type of termination control used for averaging. This determines the averaging action after the specified number of data acquisitions (average count) is reached.

EXPonential – Each successive data acquisition after the average count is reached, is exponentially weighted and combined with the existing average.

REPeat – After reaching the average count, the averaging is reset and a new average is started.

Factory Preset: REPeat

Remarks: You must be in the cdma2000, W-CDMA, or 1xEV-DO mode to use this command. Use INSTRUMENT:SElect to set the mode.

Intermodulation—Integration Bandwidth

```
[ :SENSe ] :IM:BANDwidth | BWIDth:INTEgration <freq>
```

```
[ :SENSe ] :IM:BANDwidth | BWIDth:INTEgration?
```

Set the Integration Bandwidth (IBW) that will be used.

Factory Preset: 1.23 MHz for cdma2000, 1xEV-DO

3.84 MHz for W-CDMA

Range: 100.0 kHz to 5.0 MHz

Default Unit: Hz

Remarks: You must be in the cdma2000, W-CDMA, or 1xEV-DO mode to use this command. Use INSTRUMENT:SElect to set the mode.

Intermodulation—Resolution Bandwidth

```
[ :SENSe ] :IM:BANDwidth | BWIDth [ :RESolution ] <freq>
```

```
[ :SENSe ] :IM:BANDwidth | BWIDth [ :RESolution ] ?
```

Set the resolution bandwidth that will be used for the Transmitter IM measurement mode. If span is set to a value greater than 5 MHz, minimum resolution bandwidth is limited to 1 kHz.

Factory Preset: Auto coupled.

Range: 100 Hz to 300.0 kHz

Default Unit: Hz

Remarks: You must be in the cdma2000, W-CDMA, or 1xEV-DO mode to use this command. Use INSTRument:SElect to set the mode.

Intermodulation—Resolution Bandwidth State

```
[ :SENSe ] :IM:BANDwidth | BWIDth [ :RESolution ] :AUTO OFF | ON | 0 | 1
```

```
[ :SENSe ] :IM:BANDwidth | BWIDth [ :RESolution ] :AUTO?
```

Select auto (default value) or manual (user entered value) to set the resolution bandwidth.

Factory Preset: ON

Remarks: You must be in the cdma2000, W-CDMA, or 1xEV-DO mode to use this command. Use INSTRument:SElect to set the mode.

Intermodulation—Root Raised Cosine Filter Alpha

```
[ :SENSe ] :IM:FILTer [ :RRC ] :ALPHa <numeric>
```

```
[ :SENSe ] :IM:FILTer [ :RRC ] :ALPHa?
```

Set the alpha value of the Root Raised Cosine (RRC) filter.

Factory Preset: 0.22

Range: 0.01 to 0.5

Remarks: You must be in the W-CDMA mode to use this command. Use INSTRument:SElect to set the mode.

Intermodulation—Root Raised Cosine Filter State

`[:SENSe] :IM:FILTeR [:RRC] [:STATe] OFF | ON | 0 | 1`

`[:SENSe] :IM:FILTeR [:RRC] [:STATe] ?`

Turn the Root Raised Cosine (RRC) filter on or off.

Factory Preset: ON

Remarks: You must be in the W-CDMA mode to use this command. Use `INSTRument:SElect` to set the mode.

Intermodulation—Base Frequency Auto Search

`[:SENSe] :IM:FREQuency:AUTO OFF | ON | 0 | 1`

`[:SENSe] :IM:FREQuency:AUTO?`

Turn the base frequency auto search function on or off.

OFF – the frequencies set by the `[:SENSe] :IM:FREQuency` are used.

ON – automatically determined by searching the entire span.

Factory Preset: ON

Remarks: You must be in the cdma2000, W-CDMA, or 1xEV-DO mode to use this command. Use `INSTRument:SElect` to set the mode.

Intermodulation—Base Frequencies Delta

`[:SENSe] :IM:FREQuency [:BASE] :DELTA <freq>`

`[:SENSe] :IM:FREQuency [:BASE] :DELTA?`

Set the delta frequency which is (the base upper frequency – the base lower frequency).

Factory Preset: Auto coupled.

Range: E4406A
–4.3214 GHz to 4.3214 GHz

PSA
–3.0000 GHz to 3.0000 GHz

Default Unit: Hz

Remarks: Frequency step value is set by
`[:SENSe] :FREQuency:CENTer:STEP [:INCRement]`

You must be in the cdma2000, W-CDMA, or 1xEV-DO mode to use this command. Use INSTRument:SElect to set the mode.

Intermodulation—Base Lower Frequency

`[:SENSe] :IM:FREQuency [:BASE] :LOWer <freq>`

`[:SENSe] :IM:FREQuency [:BASE] :LOWer?`

Set the frequency value of the base lower frequency. The available lower limit value is dependent on the Resolution Bandwidth setting.

Factory Preset: Auto coupled.

Range: E4406A
1 kHz to 4.3214 GHz

PSA
1 kHz to 3.0 GHz

Default Unit: Hz

Remarks: Frequency step value is set by
`[:SENSe] :FREQuency:CENTer:STEP [:INCRement]`

You must be in the cdma2000, W-CDMA, or 1xEV-DO mode to use this command. Use INSTRument:SElect to set the mode.

Intermodulation—Base Upper Frequency

`[:SENSe] :IM:FREQuency [:BASE] :UPPer <freq>`

`[:SENSe] :IM:FREQuency [:BASE] :UPPer?`

Set the frequency value of the base upper frequency. The available lower limit value is dependent on the Resolution Bandwidth setting.

Factory Preset: Auto coupled.

Range: E4406A
1 kHz to 4.3214 GHz

PSA
1 kHz to 3.0 GHz

Default Unit: Hz

Remarks: Frequency step value is set by
`[:SENSe] :FREQuency :CENTer :STEP [:INCRement]`

You must be in the cdma2000, W-CDMA, or 1xEV-DO mode to use this command. Use `INSTRument:SElect` to set the mode.

Intermodulation—Span

`[:SENSe] :IM:FREQuency:SPAN <freq>`

`[:SENSe] :IM:FREQuency:SPAN?`

Set the span.

Factory Preset: 20.0 MHz for cdma2000, 1xEV-DO
50.0 MHz for W-CDMA

Range: 100.0 kHz to 100.0 MHz

Default Unit: Hz

Remarks: You must be in the cdma2000, W-CDMA, or 1xEV-DO mode to use this command. Use `INSTRument:SElect` to set the mode.

Intermodulation—Measurement Mode

[:SENSe] :IM:MODE AUTO | TWOTone | TXIM

[:SENSe] :IM:MODE?

Select the measurement mode of the intermodulation measurement.

AUTO – Automatically identifies the intermodulation caused by the two-tone or transmit intermodulation signals.

Two-tone (TWOTone)– Measures the two-tone intermodulation products.

Transmit (TXIM)– Measures the transmit intermodulation products.

Factory Preset: AUTO

Remarks: You must be in the cdma2000, W-CDMA, or 1xEV-DO mode to use this command. Use INSTRUMENT:SElect to set the mode.

Intermodulation—Measurement Reference

[:SENSe] :IM:REFeRence AUTO | AVERAge | LOWer | UPPer

[:SENSe] :IM:REFeRence?

Select the measurement reference of the intermodulation measurement.

AUTO – Automatically sets the highest level signal in two base signals as measurement reference.

AVERAge – Sets the average level of the base lower carrier and upper carrier frequency as measurement reference.

LOWer – Sets the base lower carrier as measurement reference.

UPPer – Sets the base upper carrier as measurement reference.

Factory Preset: AUTO

Remarks: You must be in the cdma2000, W-CDMA, or 1xEV-DO mode to use this command. Use INSTRUMENT:SElect to set the mode.

Multi Carrier Power Measurement

Commands for querying the multi carrier power measurement results and for setting to the default values are found in the “[MEASure Group of Commands](#)” on page 654. The equivalent front-panel keys for the parameters described in the following commands, are found under the **Meas Setup** key, after the **Multi Carrier Power** measurement has been selected from the **MEASURE** key menu.

History: E4406A:
Added version A.04.00 and later

Multi Carrier Power—Average Count

```
[ :SENSe ] :MCPower :AVERAge :COUNT <integer>
```

```
[ :SENSe ] :MCPower :AVERAge :COUNT?
```

Set the number of data acquisitions that will be averaged. After the specified number of average counts, the average mode (termination control) setting determines the average action.

Factory Preset: 10

Range: 1 to 10,000

Remarks: You must be in the W-CDMA mode to use this command. Use **INSTRument:SElect** to set the mode.

Multi Carrier Power—Averaging State

```
[ :SENSe ] :MCPower :AVERAge [ :STATe ] OFF | ON | 0 | 1
```

```
[ :SENSe ] :MCPower :AVERAge [ :STATe ] ?
```

Turn the averaging function On or Off.

Factory Preset: ON

Remarks: You must be in the W-CDMA mode to use this command. Use **INSTRument:SElect** to set the mode.

Multi Carrier Power—Averaging Termination Control

```
[ :SENSe] :MCPower:AVERAge:TCONtrol EXPonential | REPeat
```

```
[ :SENSe] :MCPower:AVERAge:TCONtrol?
```

Select the type of termination control used for averaging. This determines the averaging action after the specified number of data acquisitions (average count) is reached.

EXPonential – Each successive data acquisition after the average count is reached, is exponentially weighted and combined with the existing average.

REPeat – After reaching the average count, the averaging is reset and a new average is started.

Factory Preset: REPeat

Remarks: You must be in the W-CDMA mode to use this command. Use INSTRument:SElect to set the mode.

Multi Carrier Power—Root Raised Cosine Filter Alpha

```
[ :SENSe] :MCPower:FILTer [:RRC] :ALPHa <numeric>
```

```
[ :SENSe] :MCPower:FILTer [:RRC] :ALPHa?
```

Set the alpha value of the Root Raised Cosine (RRC) filter.

Factory Preset: 0.22

Range: 0.01 to 0.5

Remarks: You must be in the W-CDMA mode to use this command. Use INSTRument:SElect to set the mode.

Multi Carrier Power—Root Raised Cosine Filter State

```
[ :SENSe] :MCPower:FILTer [:RRC] [:STATE] OFF | ON | 0 | 1
```

```
[ :SENSe] :MCPower:FILTer [:RRC] [:STATE] ?
```

Turn the Root Raised Cosine (RRC) filter on or off.

Factory Preset: ON

Remarks: You must be in the W-CDMA mode to use this command. Use INSTRument:SElect to set the mode.

Multi Carrier Power—Base Frequencies Delta

`[[:SENSE]:MCPower:FREQUENCY[:BASE]:DELTA <freq>`

`[[:SENSE]:MCPower:FREQUENCY[:BASE]:DELTA?`

Set the delta frequency, the base upper frequency – the base lower frequency.

Factory Preset: 5 MHz

Range: -15 MHz, -10 MHz, -5 MHz, 5 MHz, 10 MHz, or 15 MHz

Default Unit: Hz

Remarks: You must be in the W-CDMA mode to use this command. Use INSTRUMENT:SELECT to set the mode.

Multi Carrier Power—Offset Frequency Absolute Limit

`[[:SENSE]:MCPower:OFFSet:LIST:ABSolute
<abs_power>,<abs_power>,<abs_power>,<abs_power>`

`[[:SENSE]:MCPower:OFFSet:LIST:ABSolute?`

Sets the absolute amplitude levels to test against for each of the custom offsets. The list must contain four (4) entries. If there is more than one offset, the offset closest to the carrier channel is the first one in the list. `[[:SENSE]:MCPower:OFFSet:LIST:TEST` selects the type of testing to be done at each offset.

The query returns four (4) real numbers that are the current absolute amplitude test limits.

Factory Preset:

Offset A	Offset B	Offset C	Offset D
50 dBm	50 dBm	50 dBm	50 dBm

Range: -200.0 to 50.0 dBm

Remarks: You must be in the W-CDMA mode to use this command. Use INSTRUMENT:SELECT to set the mode.

Multi Carrier Power—Offset Frequency Relative Limit to Carrier

```
[ :SENSE ] :MCPower:OFFSet:LIST:RCARrier
<rel_power>, <rel_power>, <rel_power>,
<rel_power>
```

```
[ :SENSE ] :MCPower:OFFSet:LIST:RCARrier?
```

Sets the amplitude levels to test against for any custom offsets. This amplitude level is relative to the carrier amplitude. If multiple offsets are available, the list contains four (4) entries. The offset closest to the carrier channel is the first one in the list.

[:SENSE] :MCPower:OFFSet:LIST:TEST selects the type of testing to be done at each offset.

The query returns four (4) real numbers that are the current amplitude test limits, relative to the carrier, for each offset.

Factory Preset:

Offset A	Offset B	Offset C	Offset D
0 dB	0 dB	0 dB	0 dB

Range: -150.0 to 50.0 dB

Remarks: You must be in the W-CDMA mode to use this command. Use INSTRument:SElect to set the mode.

Multi Carrier Power—Offset Frequency Test Mode

`[[:SENSE]:MCPower:OFFSet:LIST:TEST ABSolute|AND|OR|RELative, ABSolute|AND|OR|RELative, ABSolute|AND|OR|RELative, ABSolute|AND|OR|RELative]`

`[[:SENSE]:MCPower:OFFSet:LIST:TEST?`

Define the type of testing to be done at any custom offset frequencies. The measured powers are tested against the absolute values defined with `[[:SENSE]:MCPower:OFFSet[n]:LIST:ABSolute]`, or the relative values defined with `[[:SENSE]:MCPower:OFFSet[n]:LIST:RCARrierr]`.

The types of the testing that can be done for each offset include:

- **ABSolute** - Test the absolute power measurement. If it fails, then return a failure for the measurement at this offset.
- **AND** - Test both the absolute power measurement and the power relative to the carrier. If they both fail, then return a failure for the measurement at this offset.
- **OR** - Test both the absolute power measurement and the power relative to the carrier. If either one fails, then return a failure for the measurement at this offset.
- **RELative** - Test the power relative to the carrier. If it fails, then return a failure for the measurement at this offset.

Factory Preset:

Offset A	Offset B	Offset C	Offset D
REL	REL	REL	REL

Remarks: You must be in the W-CDMA mode to use this command. Use `INSTRument:SElect` to set the mode.

Multi Carrier Power—Offset Selection

```
[ :SENSe ] :MCPower:OFFSet:SElect ALL | TFS | TOI
```

```
[ :SENSe ] :MCPower:OFFSet:SElect?
```

Select measurements on offsets.

ALL – All adjacent and alternate channels are measured include between two carriers.

Third, fifth, and seventh order intermodulation (TFS) – The third, fifth, and seventh order intermodulation parts are measured.

Third order intermodulation (TOI) – Only the third order Intermodulation part is measured.

Factory Preset: All

Remarks: You must be in the W-CDMA mode to use this command. Use INSTRument:SElect to set the mode.

Multi Carrier Power—Measurement Reference

```
[ :SENSe ] :MCPower:REFerence AUTO | AVERage | LOWer | UPPer
```

```
[ :SENSe ] :MCPower:REFerence?
```

Select the measurement reference of the multi carrier power measurement.

AUTO – Automatically sets the highest level signal in two base signals as measurement reference.

AVERage – Sets the average level of the base lower carrier and upper carrier frequency as measurement reference.

LOWer – Sets the base lower carrier as measurement reference.

UPPer – Sets the base upper carrier as measurement reference.

Factory Preset: AUTO

Remarks: You must be in the W-CDMA mode to use this command. Use INSTRument:SElect to set the mode.

Occupied Bandwidth Measurement

Commands for querying the occupied bandwidth measurement results and for setting to the default values are found in the “[MEASure Group of Commands](#)” on page 654. The equivalent front-panel keys for the parameters described in the following commands, are found under the **Meas Setup** key, after the **Occupied BW** measurement has been selected from the **MEASURE** key menu.

Occupied Bandwidth—Average Count

```
[ :SENSe ] :OBW:AVERAge:COUNT <integer>
```

```
[ :SENSe ] :OBW:AVERAge:COUNT?
```

Set the number of data acquisitions that will be averaged. After the specified number of average counts, the average mode (termination control) setting determines the average action.

Factory Preset: 10

Range: 1 to 10,000

Remarks: This command is used for measurements in the MEASURE menu.

You must be in the PDC, cdma2000, W-CDMA, or 1xEV-DO mode to use this command. Use INSTRument:SElect to set the mode.

History: E4406A:
Version A.02.00 or later

Key Path: **Meas Setup, Avg Number**

Occupied Bandwidth—Averaging State

`[:SENSe] :OBW:AVERAge [:STATe] OFF | ON | 0 | 1`

`[:SENSe] :OBW:AVERAge [:STATe] ?`

Turn the averaging function on or off.

Factory Preset: ON

Remarks: You must be in the PDC, cdma2000, W-CDMA, or 1xEV-DO mode to use this command. Use INSTRUMENT:SELEct to set the mode.

History: E4406A:
Version A.02.00 or later

Key Path: **Meas Setup, Avg Number**

Occupied Bandwidth—Averaging Termination Control

`[:SENSe] :OBW:AVERAge:TCONtrol EXPonential | REPEat`

`[:SENSe] :OBW:AVERAge:TCONtrol ?`

Select the type of termination control used for the averaging function. This determines the averaging action after the specified number of data acquisitions (average count) is reached.

EXPonential - After the average count is reached, each successive data acquisition is exponentially weighted and combined with the existing average.

REPEat - After reaching the average count, the averaging is reset and a new average is started.

Factory Preset: EXPonential for PDC, iDEN, WiDEN

REPEat for cdma2000, W-CDMA, 1xEV-DO

Remarks: You must be in the PDC, cdma2000, W-CDMA, or 1xEV-DO mode to use this command. Use INSTRUMENT:SELEct to set the mode.

History: E4406A:
Version A.02.00 or later

Key Path: **Meas Setup, Avg Mode**

Occupied Bandwidth—Resolution Bandwidth

```
[ :SENSE ] :OBW:BANDwidth|BWIDth[:RESolution] <freq>
```

```
[ :SENSE ] :OBW:BANDwidth|BWIDth[:RESolution] ?
```

Set the resolution bandwidth that will be used.

Factory Preset: 30.0 kHz

Range: 1.0 kHz to 1.0 MHz

Default Unit: Hz

Remarks: You must be in the cdma2000, W-CDMA, or 1xEV-DO mode to use this command. Use INSTRUMENT:SELECT to set the mode.

Occupied Bandwidth—FFT Window

```
[ :SENSE ] :OBW:FFT:WINDow[:TYPE]
```

```
BH4Tap|BLACkman|FLATtop|GAUSSsian|HAMMING  
|HANNing|KB70|KB90|KB110|UNIFORM
```

```
[ :SENSE ] :OBW:FFT:WINDow[:TYPE] ?
```

Select the FFT window type.

BH4Tap - Blackman Harris with 4 taps

BLACkman - Blackman

FLATtop - flat top, set to the default (for high amplitude accuracy)

GAUSSsian - Gaussian with alpha of 3.5

HAMMING - Hamming

HANNing - Hanning

KB70, 90, and 110 - Kaiser Bessel with sidelobes at -70, -90, or -110 dBc

UNIFORM - no window is used. (This is the unity response.)

Factory Preset: GAUSSsian

Remarks: You must be in the cdma2000, W-CDMA, or 1xEV-DO mode to use this command. Use INSTRUMENT:SELECT to set the mode.

Occupied Bandwidth—Span

`[:SENSe] :OBW:FREQuency:SPAN <freq>`

`[:SENSe] :OBW:FREQuency:SPAN?`

Set the occupied bandwidth span. The analyzer span will retain this value throughout the measurement.

Factory Preset: 10.0 MHz

3.75 MHz for cdma2000, 1xEV-DO

Range: 10.0 kHz to 10.0 MHz

Default Unit: Hz

Remarks: You must be in the PDC, cdma2000, W-CDMA, or 1xEV-DO mode to use this command. Use INSTRument:SElect to set the mode.

Occupied Bandwidth—Trigger Source

iDEN mode (E4406A)

`[:SENSe] :OBW:TRIGger:SOURce`

`EXTErnal [1] | EXTErnal2 | IF | IMMEDIATE | RFBurst`

`[:SENSe] :OBW:TRIGger:SOURce?`

PDC mode

`[:SENSe] :OBW:TRIGger:SOURce`

`EXTErnal [1] | EXTErnal2 | IF | IMMEDIATE | RFBurst`

`[:SENSe] :OBW:TRIGger:SOURce?`

cdma2000, W-CDMA, 1xEV-DO mode

`[:SENSe] :OBW:TRIGger:SOURce`

`EXTErnal [1] | EXTErnal2 | FRAME | IF | IMMEDIATE | LINE
| RFBurst`

`[:SENSe] :OBW:TRIGger:SOURce?`

Select one of the trigger sources used to control the data acquisitions for the occupied bandwidth measurement.

EXTernal1 – rear-panel external trigger input

EXTernal2 – front-panel external trigger input

FRAMe – internal frame trigger (cdma2000, W-CDMA, 1xEV-DO mode only)

IF – internal IF envelope (video) trigger

IMMediate – the next data acquisition is immediately taken, capturing the signal asynchronously (also called free run)

LINE – power line (cdma2000, W-CDMA, 1xEV-DO mode only)

RFBurst – wideband RF burst envelope trigger that has automatic level control for periodic burst signals

Factory Preset: IMMEDIATE for BS in PDC, cdma2000, W-CDMA, 1xEV-DO mode

RFBurst for MS in PDC mode

IF for iDEN, WiDEN (E4406A)

Remarks:

You must be in the PDC, iDEN (E4406A), cdmaOne, cdma2000, W-CDMA, or 1xEV-DO mode to use this command. Use INSTRUMENT:SElect to set the mode.

History:

E4406A:

Version A.02.00 or later

Power Control Measurement

Commands for querying the power control results are found in the “MEASure Group of Commands” on page 519.

Power Control—ADC Range

```
[ :SENSe ] :PCONtrol:ADC:RANGe AUTO | APEak | APLock | NONE |
M6 | P0 | P6 | P12 | P18 | P24
```

```
[ :SENSe ] :PCONtrol:ADC:RANGe?
```

Select a ranging function for the ADC gain control. Available only when Meas Type is Slot Phase. Otherwise, ADC Range is hard coded in the source code as AUTO or something like that. This is an advanced control that normally does not need to be changed. (This is hardware dependant, and should be checked if this is OK for CSSJ.)

AUTO - automatic ranging For FFT spectrums, the auto ranging should not be used. An exception to this would be if you know that your signal is “bursty”. Then you might use auto to maximize the time domain dynamic range as long as you are not very interested in the FFT data.

APEak (Auto Peak) - automatic ranging to the peak signal level For CW signals, the default of auto-peak ranging can be used, but a better FFT measurement of the signal can be made by selecting one of the manual ranges that is available by specifying NONE, or P0 through P18. Auto peaking can cause the ADC gain to monotonically track the ranges down during the data capture. This tracking effect should be negligible for the FFT spectrum, but selecting a manual range solves this possibility. Note that if the CW signal being measured is close to the auto-ranging threshold, the noise floor may shift as much as 6 dB every sweep.

APLock (Auto Peak Lock) - automatic ranging locked to the peak signal level For CW signals, auto-peak lock ranging may be used. It will find the ADC gain most appropriate for this particular signal and will not track the ranges as auto-peak can. Note that if the CW signal being measured is close to the auto-ranging threshold, the noise floor may shift as much as 6 dB every sweep. For “bursty” signals, auto-peak lock ranging should not be used. Since the ADC range can often be locked to the wrong one resulting in overloading the ADC, the measurement will fail.

NONE - turns off any auto-ranging without making any changes to the current setting.

P0 thru P18, P24, M6 - manually selects one of the ADC ranges that add 0 dB(P0) to 18(P18) dB and -6 dB (M6), 24 dB (P24) to the fixed gain across the range. Manual ranging is best for CW signals.

Notes	Grayout if MeasType is not Slot Phase. For PSA and E4406A VSA with 14bit ADC, the default value is "NONE", and available choices are: Auto Auto Peak AutoPeakLock None 0dB +6dB +12dB +18dB. For E4406A VSA with 12bit ADC, the default value is "-6dB", and the available choices are: Auto Auto Peak AutoPeakLock -6dB 0dB +6dB +12dB +18dB +24dB.
State Saved	Saved in instrument state.
Range	Auto Auto Peak AutoPeakLock None -6dB 0dB +6dB +12dB +18dB +24dB
Key Path	Meas Setup, More, More, Advanced

Power Control—Resolution Bandwidth

```
[[:SENSe]:PCONtrol:BANDwidth|BWIDth[:RESolution] <freq>
```

```
[[:SENSe]:PCONtrol:BANDwidth|BWIDth[:RESolution] ?
```

Set the resolution BW.

Example	:SENSe:PCONtrol:BANDwidth:RESolution 5.0e6
Notes	MIN: 1.0 MHz if RBW filter type = FLATtop 100.0 kHz if RBW filter type = GAUSSian MAX: 10 MHz if RBW filter type = FLATtop 8 MHz if RBW filter type = GAUSSian
Preset	5.00000 MHz
State Saved	Saved in instrument state.
SCPI Resolution	1.000 kHz
Key Path	Meas Setup, More, Advanced
Front-panel Unit/Terminator Keys	Hz kHz MHz GHz
Unit/Terminator Keys	Hz kHz MHz GHz
Range:	1.0 MHz to 10 MHz if RBW filter type = FLATtop 100.0 kHz to 8 MHz if RBW filter type = GAUSSian
Remarks:	You must be in the W-CDMA mode to use this command. Use INSTRument:SElect to set the mode.

Power Control—RBW Filter Type

`[[:SENSE]:PCONTrol:BANDwidth|BWIDth[:RESolution]:TYPE
FLATtop|GAUSSian`

`[[:SENSE]:PCONTrol:BANDwidth|BWIDth[:RESolution]:TYPE?`

Set the resolution BW filter type.

Example	<code>:SENSE:PCONTrol:BANDwidth:RESolution:TYPE E FLATtop</code>
Preset	FLATtop
State Saved	Saved in instrument state.
Range	Gaussian Flat
Key Path	Meas Setup, More, Advanced

Remarks: You must be in the W-CDMA mode to use this command. Use `INSTrument:SElect` to set the mode.

Power Control—Data Capture Length

`[[:SENSE]:PCONTrol:CAPTure:TIME <numeric>`

`[[:SENSE]:PCONTrol:CAPTure:TIME?`

Set Capture Interval for Power Control Measurement.

Example	<code>:SENSE:PCONTrol:CAPTure:TIME 4.0</code>
Notes	To keep consistency, this parameter has to be controlled with float numeric from RUI, but MUI uses Enum for easier operation.
Preset	4.0
State Saved	Saved in instrument state.
Range	1.0 2.0 4.0 8.0
Range:	1.0, 2.0, 4.0, or 8.0 The number between two settable values is rounded to the nearest value.
Remarks:	You must be in the W-CDMA mode to use this command. Use <code>INSTRument:SELEct</code> to set the mode.

Power Control—Chip Rate

`[[:SENSE]:PCONTrol:CRATe <freq>`

`[[:SENSE]:PCONTrol:CRATe?`

Set the chip rate.

Example	:SENSe:PCONTrol:CRATe 3.84e6
Preset	3.84 MHz
State Saved	Saved in instrument state.
SCPI Resolution	1.0 kHz
Key Path	Meas Setup, More, Advanced
Front-panel Unit/Terminator Keys	Hz kHz MHz GHz
Unit/Terminator Keys	Hz kHz MHz GHz

Range: 3.456 MHz to 4.224 MHz

Remarks: You must be in the W-CDMA mode to use this command. Use INSTRument:SElect to set the mode.

Power Control—Root Raised Cosine Alpha

`[[:SENSE]:PCONTrol:FILTer[:RRC]:ALPHa <numeric>`

`[[:SENSE]:PCONTrol:FILTer[:RRC]:ALPHa?`

Set the alpha (roll-off factor) to the Root Raised Cosine (RRC) filter.

Example	:SENSe:PCONTrol:FILTer:RRC:ALPHa 0.22
Preset	0.220
State Saved	Saved in instrument state.
SCPI Resolution	0.01
Key Path	Meas Setup, More, Advanced

Range: 0.01 to 0.5

Remarks: You must be in the W-CDMA mode to use this command. Use INSTRument:SElect to set the mode.

Power Control—Root Raised Cosine Filter Control

`[:SENSE] :PCONtrol:FILTer [:RRC] [:STATe] OFF | ON | 0 | 1`

`[:SENSE] :PCONtrol:FILTer [:RRC] [:STATe] ?`

Turn Root Raised Cosine Filter On or Off.

Example	<code>:SENSe:PCONtrol:FILTer:RRC:STATe OFF</code>
Preset	0
State Saved	Saved in instrument state.
Range	On Off
Key Path	Meas Setup

Remarks: You must be in the W-CDMA mode to use this command. Use `INSTRument:SElect` to set the mode.

Power Control—Measurement Data Type

`[:SENSE] :PCONtrol:METHod WAVEform | CPOWER`

`[:SENSE] :PCONtrol:METHod?`

Set Power Control Acquisition method to Waveform or Chip Power.

WAVEform - Measure and perform power calculation based on waveform (raw data of A/D).

CPOWER - Measure and perform power calculation based on chip power (resample on chip clock).

Example	<code>:SENSe:PCONtrol:METHod WAVEform</code>
Notes	This parameter is available if Meas Type is Slot Power or PRACH Power. This parameter is grayed out if Meas Type is Slot Phase.
Preset	WAVEform
State Saved	Saved in instrument state.
Range	Chip Power Waveform
Key Path	Meas Setup

Remarks: You must be in the W-CDMA mode to use this command. Use `INSTRument:SElect` to set the mode.

Power Control—PRACH Noise Floor

```
[ :SENSE ] :PCONTrol:PRACH:NFLoor <power>
```

```
[ :SENSE ] :PCONTrol:PRACH:NFLoor?
```

When the Meas Type is set to PRACH, it lets you enter the value of the measurement noise floor. This improves the sensitivity of PRACH preamble burst detection since the entered value changes the measurement setup to a more optimum amplitude range. The burst detection is most improved when the entered value is significantly different from the default.

Notes	Grayout when Meas Type is not PRACH Power.
Preset	-69.0
State Saved	Saved in instrument state.
SCPI Resolution	0.1
Key Path	Meas Setup, More, More, Advanced
Range:	-156.0 dBm to -36 dBm
Remarks:	The Meas Type must be set to PRACH. You must be in the W-CDMA mode to use this command. Use INSTRument:SElect to set the mode.
Key Path:	Meas Setup, Advanced

Power Control—PRACH Preamble Signature

`[[:SENSe]:PCONtrol:PRACH:SIGNature <integer>`

`[[:SENSe]:PCONtrol:PRACH:SIGNature?`

Set Signature number for PRACH Preamble detection, when `[[:SENSe]:PCONtrol:PRACH:SIGNature:AUTO` is set to OFF. This value is set at its auto number if PRACH Preamble Signature Auto mode is set to ON.

Example	<code>:SENSe:PCONtrol:PRACH:SIGNature 0</code> <code>:SENSe:PCONtrol:PRACH:SIGNature:AUTO ON</code>
Notes	When Auto, detected PRACH Preamble signature should be displayed. If synchronization failed, "---" should be displayed.
Remote Command Notes	Set Signature Auto mode ON for PRACH Preamble detection.
Preset	0, , 1
State Saved	Saved in instrument state.
SCPI Resolution	1
Key Path	Meas Setup, PRACH Power Meas
Range:	0 to 15
Remarks:	You must be in the W-CDMA mode to use this command. Use <code>INSTRument:SElect</code> to set the mode.

Power Control—PRACH Preamble Signature Detection

`[[:SENSe]:PCONtrol:PRACH:SIGNature:AUTO OFF|ON|0|1`

`[[:SENSe]:PCONtrol:PRACH:SIGNature:AUTO?`

Set Signature Auto mode ON for PRACH Preamble detection.

Factory Preset: ON

Remarks: You must be in the W-CDMA mode to use this command. Use `INSTRument:SElect` to set the mode.

Power Control—Symbol Boundary Custom Active Channel List MS [MS only]

```
[[:SENSE]:PCONTrol:SBOundary:LIST:MS:INIT <symbol_rate>,  
<code_num>, IPH|QPH
```

```
[[:SENSE]:PCONTrol:SBOundary:LIST:MS:APPend <symbol_rate>,  
<code_num>, IPH|QPH
```

```
[[:SENSe]:PCONTrol:SBOundary:LIST:MS:REPLace <entry_id>,  
<symbol_rate>, <code_num>, IPH|QPH
```

```
[[:SENSe]:PCONTrol:SBOundary:LIST:MS:CHANnel? <entry_id>
```

This initializes the the current custom active channel list. This creates a new entry with the given parameter.

1st parameter:

<symbol_rate> This parameter specifies symbol rate of the channel.

2nd parameter:

<code_num> This parameter specifies spreading code of the channel.

3rd parameter:

IPH Specifies the channel is on I-axis.

QPH Specifies the channel Is on Q-axis.

Example

In order to predefine the following channels:

- DPCCH (C8(0):Q)
- DPDCH (C6(16):I)

```
:SENSe:PCONtrol:SBOundary:LIST:MS:INIT  
15000, 0, QPH  
:SENSe:PCONtrol:SBOundary:LIST:MS:APPend  
60000, 16, IPH
```

```
:SENSe:PCONtrol:SBOundary:LIST:MS:NCHan  
nels?  
2
```

```
:SENSe:PCONtrol:SBOundary:LIST:MS:CHANn  
el? 1  
15000, 0, QPH
```

```
:SENSe:PCONtrol:SBOundary:LIST:MS:CHANn  
el? 2  
60000, 16, IPH
```

Notes

- (1) This command is effective if
[:SENSe]:RADio:DEVice is set to MS and
[:SENSe]:PCONtrol:SBOundary:MS is set to
CUSTom.
- (2) symbol_rate = 1920000 is available if
HSDPA/HSUPA Enable is On.
- (3) The maximum number of entries is 512.

Remote Command
Notes

One of the following error messages will be logged if the given parameter is invalid.

If error is reported, the SCPI command is rejected and instrument's settings does not change.

(1) "Missing Parameter" (PSA: -109, E4406A VSA: -109) This error is reported if the number of parameters is less than 3.

For example:

```
:SENSe:PCONtrol:SBOundary:LIST:MS:INIT  
15000, 0 ? 3rd parameter is missing.
```

(2) "Illegal parameter value" (PSA: -224, E4406A VSA: -224) This error is reported if parameter type is invalid or if enum value is invalid.

For example:

```
:SENSe:PCONtrol:SBOundary:LIST:MS:INIT  
15000, ON, QPH ? 2nd parameter must be  
integer.
```

```
SENSe:PCONtrol:SBOundary:LIST:MS:INIT  
15001, 0, QPH ? 1st parameter value (Symbol  
Rate) is not allowed.
```

Only the values given in Range field are valid for the Symbol Rate. You may specify these in numeric form, but they are interpreted as an enumeration and the error will result if the value does not translate to one in the list.

(3) "Data out of range" (PSA: -222, E4406A VSA: -222) This error is reported if parameter value is out of range.

For example

```
:SENSe:PCONtrol:SBOundary:LIST:MS:INIT  
15000, 256, QPH ? 2nd parameter is out of range.
```

(4) "Setting Conflict" (PSA: -221, E4406A VSA: -221) This error is reported if the given code channel overlaps other code channel on code domain.

For example:

If a user sends the following two commands, the second command causes the error message because C7(0):Q overlaps C8(0):Q.

```
:SENSe:PCONtrol:SBOundary:LIST:MS:INIT  
15000, 0, QPH ? OK  
:SENSe:PCONtrol:SBOundary:LIST:MS:APPend  
30000, 0, QPH ? C7(0):Q overlaps C8(0):Q
```

State Saved

Saved in instrument state.

Range	symbol_rate = 15000 30000 60000 120000 240000 480000 960000 1920000 0<= code_num <= 255 if symbol_rate = 15000 0<= code_num <= 127 if symbol_rate = 30000 0<= code_num <= 63 if symbol_rate = 60000 0<= code_num <= 31 if symbol_rate = 120000 0<= code_num <= 15 if symbol_rate = 240000 0<= code_num <= 7 if symbol_rate = 480000 0<= code_num <= 3 if symbol_rate = 960000 0<= code_num <= 1 if symbol_rate = 1920000
Key Path	no support (SCPI only)

Power Control—Symbol Boundary Custom Active Channel List—The Number Of Entries MS [MS only]

[[:SENSe]:PCONtrol:SBOundary:LIST:MS:NCHannels?]

This query-only command returns the number of entries in the custom predefined active channel list MS.

Example	:SENSe:PCONtrol:SBOundary:LIST:MS:NCHannels?
Notes	This command is effective when [:SENSe]:RADio:DEVice is set to MS and [:SENSe]:PCONtrol:SBOundary:MS is set to CUSTom.
Remote Command Notes	This command is a query-only command.
Preset	1
State Saved	No
Key Path	no support (SCPI only)

Power Control—Symbol Boundary MS [MS only]

`[[:SENSE]:PCONtrol:SBOundary:MS AUTO|CUSTom`

`[[:SENSE]:PCONtrol:SBOundary:MS?`

Select the symbol boundary detection mode for MS.

Allows you to access the selection menu for the symbol boundary detection modes to specify active channel detection scheme on uplink.

Auto [SCPI Enum: AUTO] – Select this to set the symbol boundary detection to the automatic mode. Various code channels are measured and the most appropriate code channel is selected as the reference channel.

Custom [SCPI Enum: CUSTom] – “Custom” choice provides a flexible way to specify predefined active channels. By choosing it, a you can specify a customized list of active channels by another SCPI command:

`[[:SENSE]:PCONtrol:SBOundary:LIST:MS INIT|APPend|<entry_id>, <symbol_rate>, <code_num>, IPH|QPH`

All the specified channels are considered as active.

There is no MUI (softkey) to specify custom active channel list.

NOTE

The “Custom” choice is selectable even if you have not sent the following SCPI command:

`[[:SENSE]:PCONtrol:SBOundary:LIST:MS”`

because the default custom list contains DPCCH (15000, 0, QPH) as a predefined active channel. In other words, just simply choosing “Custom” setting will make one channel (C8(0):Q) considered as active, and all other channels considered as inactive.

Example	<code>:SENSE:PCONtrol:SBOundary:MS CUST</code>
Notes	This parameter is effective when <code>[[:SENSE]:RADio:DEVice</code> is set to MS.
Dependencies and Couplings	This softkey is active if “Radio Device” selection is “MS”.
Preset	AUTO
State Saved	Saved in instrument state.
Range	Auto Custom
Key Path	Meas Setup, Slot Phase Meas

Power Control—Slot Format

```
[ :SENSe] :PCONtrol :SLOT:FORMat SF0 | SF1 | SF2 | SF3 | SF4 | SF5 | AUTO
```

```
[ :SENSe] :PCONtrol :SLOT:FORMat?
```

Allows you to get into Slot Format Menu to specify one of the slot format to be used to synchronization with DPCCH Pilot. The choice is used in two cases:

NOTE

The slot format auto-detection (Auto choice) is available only if the Meas Type is Slot Phase.

Meas Type is Slot Power AND Meas Method is Chip Power.

Meas Type is Slot Phase.

(PSA A.09 and E4406A VSA A.10) and later versions support automatic synchronization.

In the automatic synchronization process, the algorithm searches the best correlation of DPCCH pilot pattern among slot format 0, 1, 2 and 3. (The reason the algorithm doesn't search slot format 4 and 5 is that 3GPP standard release 6 no longer defines slot format 4 and 5.)

If signal in slot format 4 is given, the auto-sync algorithm considers it as slot format 0.

If signal in slot format 5 is given, the auto-sync algorithm considers it as slot format 2.

Manual setting of the slot format (SF0 to SF5) is also supported as previous.

SF0 – Slot Format 0

SF1 – Slot Format 1

SF2 – Slot Format 2

SF3 – Slot Format 3

SF4 – Slot Format 4

SF5 – Slot Format 5

Example	:SENSe:PCONtrol:SLOT:FORMat SF1
Preset	SF0
State Saved	Saved in instrument state.
Range	SF0 SF1 SF2 SF3 SF4 SF5 Auto
Key Path	Meas Setup, Slot Power Meas

Power Control—Sync Start Slot

`[:SENSE] :PCONTrol:SSLot:NUMBER <integer>`

`[:SENSE] :PCONTrol:SSLot:NUMBER?`

`[:SENSE] :PCONTrol:SSLot[:STATe] OFF|ON|0|1`

`[:SENSE] :PCONTrol:SSLot[:STATe] ?`

By enabling “Sync Start Slot” parameter “On” and specifying the slot number to measure as the first slot, customer can use any trigger (even Free Run) to get the measurement result beginning with the specified slot number.

Example (1)

- Trigger Source: Free Run (Immediate)
- Sync Start Slot state : On
- Sync Start Slot number : 0
- Capture Interval : 1 frame

The synchronization always starts from slot number 0.0 to 15.0 regardless of the trigger type.

Example (2)

If Sync Start Slot state is set to Off, the measurement performs synchronization at trigger timing.

Example	<code>:SENSE:PCONTrol:SSLot:NUMBER 5</code> <code>:SENSE:PCONTrol:SSLot:STATe ON</code>
Notes	The softkey is grayed out if device is MS and Sync Type is PRACH Message.
Remote Command Notes	Turn first slot number detection mode on or off.
Preset	0, OFF
State Saved	Saved in instrument state.
Range	0 to 14
Key Path	Meas Setup, Slot Power Meas or Slot Phase Meas
Active Function Text	Sync Start Slot

Power Control—Scramble Code Up Link

`[:SENSe] :PCONtrol:SYNC:SCRamble <integer>`

`[:SENSe] :PCONtrol:SYNC:SCRamble?`

Set the Scramble code for uplink synchronization.

Example `:SENSe:PCONtrol:SYNC:SCRamble 0`

Notes MIN: 0 (0x0; 24 bits)

MAX: 16,777,215 (0xFFFFFFFF; 24 bits)

Preset 0x0

State Saved Saved in instrument state.

SCPI Resolution 1

Key Path **Meas Setup, More**

Range: 0 to 16,777,215 (0x0 to 0xFFFFFFFF; 24 bits)

Remarks: You must be in the W-CDMA mode to use this command. Use INSTRument:SElect to set the mode.

Power Control—Trigger Source

```
[ :SENSe ] :PCONtrol:TRIGger:SOURce  
EXTernal [1] | External2 | FRAME | IF | IMMEDIATE  
| RFBurst | LINE
```

```
[ :SENSe ] :PCONtrol:TRIGger:SOURce?
```

Select the trigger source used to control the data acquisitions.

EXTernal[1] – Front-panel External Trigger Input.

EXTernal2 – Rear-panel External Trigger Input.

IMMEDIATE – the next data acquisition is immediately taken, capturing the signal asynchronously (also called Free Run).

RFBurst – internal wideband RF burst envelope trigger that has automatic level control for periodic burst signals.

IF – internal IF Envelope trigger.

FRAME – internal Frame trigger.

LINE – Power line.

Example	:SENSe:PCONtrol:TRIGger:SOURce IMMEDIATE
Preset	IMMEDIATE
State Saved	Saved in instrument state.
Range	Free Run (Immediate) Video (IF Envlp) RF Burst (IF Wideband) Ext Front Ext Rear Frame Line
Key Path	Meas Setup
Remarks:	You must be in the W-CDMA mode to use this command. Use INSTRument:SElect to set the mode.

Power Control - Measurement Type

`[[:SENSe]:PCONtrol:TYPE SPOWer|SLOT|PRACH|SPHase`

`[[:SENSe]:PCONtrol:TYPE?`

Allows you to toggle the measurement types among Slot Power, PRACH Power and Slot Phase. The sync type is automatically set either to DPCCH (for slot power and slot phase measurements) or to PRACH preamble (for PRACH power measurement) if Meas Method is set to Chip Power.

SPOWer, SLOT – Slot power measurement is performed.

PRACH – PRACH power measurement is performed.

SPHase – Slot phase measurement is performed.

Example	<code>:SENSe:PCONtrol:TYPE SPOWer</code>
Notes	SLOT is accepted for backward compatibility. It is an alias of SPOWer. The both represent Slot Power measurement type.
Preset	SPOWer
State Saved	Saved in instrument state.
Range	Slot Power PRACH Power Slot Phase
Key Path	Meas Setup

Select I/Q Power Range (E4406A only)

`[[:SENSE]:POWER:IQ:RANGE[:UPPER] <Float 64>{DBM|DBMV|W`

`[[:SENSE]:POWER:IQ:RANGE[:UPPER] ?`

Selects maximum total power expected from unit under test at test port when I or Q port is selected.

Range: For 50 Ohms:

13.0, 7.0, 1.0, -5.1 [DBM]
60.0, 54.0, 48.0, 41.9 [DBMV]
.02, .005, .0013, .00031 [W]

For 600 Ohms:

2.2, -3.8, -9.8, -15.8 [DBM]
60.0, 54.0, 48.0, 41.9 [DBMV]
.0017, .00042, .0001, .000026 [W]

Values for 1 M Ohm vary according to selected reference impedance.

Remarks: Implemented for BASIC and W-CDMA modes.

History: Version A.05.00 or later

Select I/Q Voltage Range (E4406A only)

`[:SENSe] :VOLTage:IQ:RANGe[:UPPer] <Float 64> [V]`

`[:SENSe] :VOLTage:IQ:RANGe[:UPPer] ?`

Selects upper voltage range when I or Q port is selected. This setting helps set the gain which is generated in the variable gain block of the BbIQ board to improve dynamic range.

Range: 1.0, 0.5, .025, 0.125[V]

Remarks: Implemented for BASIC and W-CDMA modes.

History: Version A.05.00 or later

RF Power Commands

RF Port Input Attenuation

```
[ :SENSE ] :POWER [ :RF ] :ATTenuation <rel_power>
```

```
[ :SENSE ] :POWER [ :RF ] :ATTenuation?
```

Set the RF input attenuator. This value is set at its auto value if RF input attenuation is set to auto.

Factory Preset: 0 dB

12 dB for iDEN (E4406A)

Range: 0 to 40 dB

Default Unit: dB

Key Path: **Input, Input Atten**

Internal RF Preamp Control

```
[ :SENSE ] :POWER [ :RF ] :GAIN [ :STATE ] OFF | ON | 0 | 1
```

```
[ :SENSE ] :POWER [ :RF ] :GAIN [ :STATE ] ?
```

Turns the internal preamp on or off for the currently selected measurement. Requires Option 1DS.

Factory Preset: OFF

Key Path: **Input/Output, More (1 of 2), Int Preamp for Optional Personalities.**

AMPLITUDE/Y Scale, More (1 of 3), Int Preamp for SA mode

Remarks: For PSA you must be in W-CDMA, cdma2000, or 1xEV-DO mode to use this command. Use INSTRUMENT:SElect to set the mode. BEFORE you can turn on the preamp using the :SENSE command, you must also send the following command- :CONFigure:RHO | EVMQpsk | CDPower.

Internal RF Preamplifier Attenuation

```
[ :SENSE ] :POWER [ :RF ] :GAIN:ATTenuation <rel_power>
```

```
[ :SENSE ] :POWER [ :RF ] :GAIN:ATTenuation?
```

Specifies the internal mechanical attenuator setting when the internal preamp is on. Requires Option 1DS. This not the same attenuator used when the preamp is OFF.

Factory Preset: 0 [dB]

Key Path: Input/Output, More (1 of 2), Int Preamp for Optional Personalities.
AMPLITUDE/Y Scale, More (1 of 3), Int Preamp for SA mode

Range: 0,10, or 20 [dB]
Other numbers between 0 and 20 are rounded to the nearest number; entries between numbers are rounded up. Entries above 20 are rounded down to 20.

Remarks: You must be in W-CDMA, cdma2000, or 1xEV-DO mode with the preamp ON to use this command. Use INSTRUMENT:SElect to set the mode. BEFORE you can turn on the preamp using the :SENSE command, you must also send the following command- :CONFigure:RHO | EVMQpsk | CDPower.

Key Path: Input/Output, More (1 of 2), Attenuation

State Saved: Saved in Instrument State

RF Port Power Range Auto

```
[ :SENSE ] :POWER [ :RF ] :RANGE:AUTO OFF | ON | 0 | 1
```

```
[ :SENSE ] :POWER [ :RF ] :RANGE:AUTO?
```

Select the RF port power range to be set either automatically or manually.

ON - power range is automatically set as determined by the actual measured power level at the start of a measurement.

OFF - power range is manually set

Factory Preset: ON

Remarks: You must be in the cdmaOne, GSM, EDGE, NADC, PDC, cdma2000, W-CDMA, iDEN, or WiDEN mode to use this command. Use INSTRUMENT:SElect to set the mode.

Key Path: **Input, Max Total Pwr (at UUT)**

RF Port Power Range Maximum Total Power

`[:SENSe] :POWer [:RF] :RANGe [:UPPer] <power>`

`[:SENSe] :POWer [:RF] :RANGe [:UPPer] ?`

Set the maximum expected total power level at the radio unit under test. This value is ignored if RF port power range is set to auto. External attenuation required above 30 dBm.

Factory Preset: -15.0 dBm

Range: -100.0 to 80.0 dBm for EDGE, GSM
 -100.0 to 27.7 dBm for cdmaOne, iDEN (E4406A)
 -200.0 to 50.0 dBm for NADC, PDC
 -200.0 to 100.0 dBm for cdma2000, W-CDMA

Default Unit: dBm

Remarks: Global to the current mode. This is coupled to the RF input attenuation

For E4406A you must be in the Service, cdmaOne, EDGE(w/GSM), GSM, iDEN, NADC, PDC, cdma2000, or W-CDMA mode to use this command. Use INSTRument:SElect to set the mode.

For PSA you must be in the cdmaOne, GSM, EDGE, NADC, PDC, cdma2000, or W-CDMA mode to use this command. Use INSTRument:SElect to set the mode.

Key Path: **Input, Max Total Pwr (at UUT)**

Power Statistics CCDF Measurement

Commands for querying the statistical power measurement of the complementary cumulative distribution function (CCDF) measurement results and for setting to the default values are found in the “[MEASure Group of Commands](#)” on page 519. The equivalent front-panel keys for the parameters described in the following commands, are found under the **Meas Setup** key, after the **Power Stat CCDF** measurement has been selected from the **MEASURE** key menu.

History: E4406A:
Added PStatistic to Basic Mode version A.04.00

Power Statistics CCDF—Channel Bandwidth

```
[ :SENSe ] :PStatistic:BANDwidth|BWIDth <freq>
```

```
[ :SENSe ] :PStatistic:BANDwidth|BWIDth?
```

Enter a frequency value to set the channel bandwidth that will be used for data acquisition.

Factory Preset: 5.0 MHz

Range: 10.0 kHz to 6.7 MHz

Default Unit: Hz

Remarks: You must be in the Basic (E4406A), cdma2000, W-CDMA, or 1xEV-DO mode to use this command. Use INSTRUMENT:SElect to set the mode.

Power Statistics CCDF—Sample Counts

```
[ :SENSe ] :PStatistic:COUNTs <integer>
```

```
[ :SENSe ] :PStatistic:COUNTs?
```

Enter a value to set the sample counts. Measurement stops when the sample counts reach this value.

Factory Preset: 10,000,000

Range: 1,000 to 2,000,000,000

Unit: counts

Remarks: You must be in the Basic (E4406A), cdma2000, W-CDMA, or 1xEV-DO mode to use this command. Use INSTRUMENT:SElect to set the mode.

Power Statistics CCDF—Sweep Time

```
[[:SENSE]:PStatistic:SWEep:TIME <time>
```

```
[[:SENSE]:PStatistic:SWEep:TIME?
```

Enter a value to set the measurement interval that will be used to make measurements.

Factory Preset: 1.0 ms

Range: 0.1 ms to 10 ms

Remarks: You must be in the Basic, cdma2000, W-CDMA, or 1xEV-DO mode to use this command. Use INSTRUMENT:SELEct to set the mode.

Power Statistics CCDF—Trigger Source

```
[[:SENSE]:PStatistic:TRIGger:SOURce  
EXtErnal [1] | EXtErnal2 | FRAMe | IF | IMMEDIATE  
| RFBurst
```

```
[[:SENSE]:PStatistic:TRIGger:SOURce?
```

Select one of the trigger sources used to control the data acquisitions.

EXtErnal 1 - front-panel external trigger input

EXtErnal 2 - rear-panel external trigger input

FRAMe - uses the internal frame timer, which has been synchronized to the selected burst sync.

IF - internal IF envelope (video) trigger

IMMEDIATE - the next data acquisition is immediately taken, capturing the signal asynchronously (also called Free Run).

RFBurst - wideband RF burst envelope trigger that has automatic level control for periodic burst signals.

Factory Preset: IMMEDIATE

Remarks: You must be in the Basic (E4406A), cdma2000, W-CDMA, or 1xEV-DO mode to use this command. Use INSTRUMENT:SELEct to set the mode.

Power vs. Time Measurement

Commands for querying the power versus time measurement results and for setting to the default values are found in the “[MEASure Group of Commands](#)” on page 519. The equivalent front-panel keys for the parameters described in the following commands, are found under the **Meas Setup** key, after the **GMSK Pwr vs Time** measurement has been selected from the **MEASURE** key menu.

Power vs. Time—Average Count

```
[ :SENSe ] :PVTime:AVERAge:COUNT <integer>
```

```
[ :SENSe ] :PVTime:AVERAge:COUNT?
```

Set the number of data acquisitions that will be averaged.

Factory Preset: 40 for W-CDMA

Range: 1 to 10,000

Remarks: You must be in the W-CDMA mode to use this command. Use **INSTRument:SElect** to set the mode.

Power vs. Time—Averaging State

```
[ :SENSe ] :PVTime:AVERAge[:STATe] OFF|ON|0|1
```

```
[ :SENSe ] :PVTime:AVERAge[:STATe]?
```

Turn averaging on or off.

Factory Preset: OFF

ON for 1xEV-DO, W-CDMA

Remarks: For E4406A you must be in the EDGE(w/GSM), GSM, 1xEV-DO, W-CDMA, or Service mode to use this command. Use **INSTRument:SElect** to set the mode.

For PSA you must be in the GSM, EDGE, 1xEV-DO or W-CDMA mode to use this command. Use **INSTRument:SElect** to set the mode.

Power vs. Time—Averaging Termination Control

```
[ :SENSe ] :PVTime:AVERAge:TCONtrol EXPonential | REPeat
```

```
[ :SENSe ] :PVTime:AVERAge:TCONtrol?
```

Select the type of termination control used for the averaging function. This specifies the averaging action after the specified number of bursts (average count) is reached.

EXPonential - After the average count has been reached, each successive data acquisition is exponentially weighted and combined with the existing average.

REPeat - After reaching the average count, the averaging is reset and a new average is started.

Factory Preset: EXPonential

REPeat for 1xEV-DO, W-CDMA

Remarks: For E4406A you must be in the EDGE(w/GSM), GSM, 1xEV-DO, W-CDMA, or Service mode to use this command. Use INSTRument:SElect to set the mode.

For PSA you must be in the GSM, EDGE, 1xEV-DO or W-CDMA mode to use this command. Use INSTRument:SElect to set the mode.

Power vs. Time—Averaging Type

EDGE (w/GSM), GSM, Service GSM, EDGE mode

```
[ :SENSe ] :PVTime:AVERAge:TYPE  
LOG | MAXimum | MINimum | MXMinimum | RMS
```

iDEN, WiDEN mode

```
[ :SENSe ] :PVTime:AVERAge:TYPE  
LOG | MAXimum | MINimum | MXMinimum | RMS | POWer
```

1xEV-DO mode

```
[ :SENSe ] :PVTime:AVERAge:TYPE LOG | MAXimum | MINimum | RMS | SCALar
```

W-CDMA mode

```
[ :SENSe ] :PVTime:AVERAge:TYPE RMS | MAXimum | MINimum
```

```
[ :SENSe ] :PVTime:AVERAge:TYPE?
```

Select the type of averaging to be performed.

LOG - The log of the power is averaged. (This is also known as video averaging.)

MAXimum - The maximum values are retained.

MINimum - The minimum values are retained.

MXMinimum - Both the maximum and the minimum values are retained. (E4406A - EDGE(W/GSM), GSM, and Service modes, and PSA - GSM, EDGE, and 1xEV-DO modes only)

RMS - The power is averaged to provide a voltage rms value.

SCALAR - The amplitude level of power is averaged to provide a voltage value. (1xEV-DO mode only)

POWER - averages the linear power of successive measurements.

Factory Preset: RMS

Remarks: For E4406A you must be in the EDGE(w/GSM), GSM, 1xEV-DO, W-CDMA, iDEN, WiDEN or Service mode to use this command. Use INSTRUMENT:SElect to set the mode.

For PSA you must be in the GSM, EDGE, 1xEV-DO, or W-CDMA mode to use this command. Use INSTRUMENT:SElect to set the mode.

Power vs. Time—Resolution BW

```
[ :SENSe ] :PVTime :BANDwidth | BWIDth [ :RESolution ] <freq>
```

```
[ :SENSe ] :PVTime :BANDwidth | BWIDth [ :RESolution ] ?
```

Enables you to set the resolution bandwidth. This is an advanced control that normally does not need to be changed. Setting this to a value other than the factory default, may cause invalid measurement results.

Factory Preset: 500 kHz1.5 MHz

5.0 MHz for W-CDMA

30 kHz for iDEN

120 kHz for WiDEN

Range: 1 kHz to 5 MHz

1.0 kHz to 10.0 MHz when PVT:BAND:RES:TYPE is set to FLATtop

1.0 kHz to 8.0 MHz when PVT:BAND:RES:TYPE is set to GAUSSian

Default Unit: Hz

Remarks: For E4406A you must be in the EDGE(w/GSM), GSM, Service, 1xEV-DO, iDEN, WiDEN, or W-CDMA mode to use this command. Use INSTRUMENT:SElect to set the mode.

For PSA you must be in the GSM, EDGE, 1xEV-DO, or W-CDMA mode to use this command. Use INSTRUMENT:SElect to set the mode.

Key Path: **Meas Setup, Advanced, Res BW**

Power vs. Time—RBW Filter Type

```
[ :SENSe ] :PVTime :BANDwidth | BWIDth [ :RESolution ] :TYPE  
FLATtop | GAUSSian
```

```
[ :SENSe ] :PVTime :BANDwidth | BWIDth [ :RESolution ] :TYPE?
```

Enables you to select the type of resolution bandwidth filter. This is an advanced control that normally does not need to be changed. Setting this to a value other than the factory default, may cause invalid measurement results.

FLATtop - a filter with a flat amplitude response, which provides the best amplitude accuracy.

GAUSSian - a filter with Gaussian characteristics, which provides the best pulse response.

Factory Preset: GAUSSian

FLATtop for 1xEV-DO, W-CDMA, WiDEN

Remarks: For E4406A you must be in the EDGE(w/GSM), GSM, Service, 1xEV-DO, iDEN, WiDEN, or W-CDMA mode to use this command. Use INSTRUMENT:SElect to set the mode.

For PSA you must be in the GSM, EDGE, 1xEV-DO, or W-CDMA mode to use this command. Use INSTRUMENT:SElect to set the mode.

Key Path: **Meas Setup, Advanced** (WiDEN).

Power vs. Time—Burst Search Threshold

```
[ :SENSe ] :PVTime :BURSt :STHReshold <rel_power>
```

```
[ :SENSe ] :PVTime :BURSt :STHReshold?
```

Specify the relative power threshold level to search for bursts. Use the commands `SENSe:PVTime:BURSt:SLOPe` and `SENSe:PVTime:BURSt:SLOPe:INTEgration:TIME` with this command.

Factory Preset: -10.00 dB

-45 dB for W-CDMA

Range: -100 to 0 dB

Remarks: You must be in the 1xEV-DO or W-CDMA mode to use this command. Use `INSTRument:SElect` to set the mode.

History: PSA: Added in version A.02.00

E4406A: Added in version A.05.00

Power vs. Time—Chip Rate

```
[ :SENSe ] :PVTime :CRATe <freq>
```

```
[ :SENSe ] :PVTime :CRATe?
```

Set the chip rate.

Factory Preset: 3.84 MHz

Range: 3.456 MHz to 4.224 MHz

Remarks: You must be in the W-CDMA mode to use this command. Use `INSTRument:SElect` to set the mode.

Power vs. Time—Root Raised Cosine Filter Alpha

```
[ :SENSe ] :PVTime :FILTer [ :RRC ] :ALPHa <numeric>
```

```
[ :SENSe ] :PVTime :FILTer [ :RRC ] :ALPHa?
```

Set the alpha of RRC filter.

Factory Preset: 0.22

Range: 0.01 to 0.5

Remarks: You must be in the W-CDMA mode to use this command. Use `INSTRument:SElect` to set the mode.

Power vs. Time—Root Raised Cosine Filter Control

```
[ :SENSE ] :PVTime:FILTer [:RRC] [:STATe] 0|1|OFF|ON
```

```
[ :SENSe ] :PVTime:FILTer [:RRC] [:STATe] ?
```

Turn RRC filter On or Off.

Factory Preset: OFF

Remarks: You must be in the W-CDMA mode to use this command. Use INSTRument:SElect to set the mode.

Power vs. Time—Limit Mask Display

```
[ :SENSe ] :PVTime:LIMit:MASK OFF|ON|0|1
```

```
[ :SENSe ] :PVTime:LIMit:MASK?
```

Show or hide the limit mask. Does not affect the pass/fail calculation for limit tests.

Factory Preset: ON

Remarks: You must be in GSM, EDGE, 1xEV-DO, or W-CDMA mode to use this command. Use INSTRument:SElect to set the mode.

Power vs. Time—Lower Mask Relative Amplitude Levels

```
[ :SENSe ] :PVTime:MASK:LIST:LOWer:RELative <rel_power>,  
<rel_power>, <rel_power>, <rel_power>
```

```
[ :SENSe ] :PVTime:MASK:LIST:LOWer:RELative?
```

Enter the relative power level for each horizontal line segment in the lower limit mask. There should be a power level for each time point entered using [:SENSe] :PVTime:MASK:LIST:LOWer:TIME, and they must be entered in the same order. These power levels are all relative to the defined Reference Power Level (the average power in the useful part of the data). When an upper and lower limit masks have been defined, the Reference Power Level is the mid-point between these two limits at time t_0 .

Any portion of the signal that has no limit line segment defined for it, will default to a very low limit (–100 dB relative to the reference power). This will keep the measurement from indicating a failure for that portion of the data.

Factory Preset: Selected standard

–100.0, –100.0, –2.5, –100.0, and –100.0 dB for
1xEV-DO

–100.0, –100.0, –1.0, –100.0, and –100.0 dB for
W-CDMA

Range: –100 to 200 dB relative to the reference power

Default Unit: dB

Remarks: You must be in GSM, EDGE, 1xEV-DO, iDEN, WiDEN,
or W-CDMA mode to use this command. Use
INSTRUMENT:SElect to set the mode.

History: E4406A: Added in revision A.03.00

Power vs. Time—Mask Lower Limit Test Mode

```
[ :SENSe ] :PVTime:MASK:LIST:LOWer:TEST RELative | NONE,  
,RELative | NONE, RELative | NONE, RELative | NONE, RELative | NONE
```

```
[ :SENSe ] :PVTime:MASK:LIST:LOWer:TEST?
```

Set the mask to the lower limit test mode.

Factory Preset: NONE, NONE, RELative, NONE, NONE

Range: Only RELative is currently available.

Remarks: You must be in 1xEV-DO or W-CDMA mode to use this
command. Use INSTRUMENT:SElect to set the mode.

History: PSA: Added in version A.02.00

E4406A: Added in version A.05.00

Power vs. Time—Mask Power Reference

```
[ :SENSe ] :PVTime:MASK:LIST:PREFereNce A | B | C | D | E
```

```
[ :SENSe ] :PVTime:MASK:LIST:PREFereNce?
```

Select the power reference from one of region (A, B, C, D or E).

Factory Preset: C

Remarks: Only one of regions can be On. If multiple regions are
set On, the first On is set and returns error. You must
be in W-CDMA mode to use this command. Use
INSTRUMENT:SElect to set the mode.

Power vs. Time—Mask Interval

```
[ :SENSE ] :PVTime:MASK:LIST:SWEep:TIME <seconds>{, <seconds>}
```

```
[ :SENSe ] :PVTime:MASK:LIST:SWEep:TIME?
```

Define the mask interval.

Factory Preset: 642.0 μ s, 50.0 μ s, 1283.0 μ s, 50.0 μ s, 642.0 μ s

Range: -10 to 10 ms

Remarks: You must be in W-CDMA mode to use this command.
Use INSTRument:SElect to set the mode.

Power vs. Time—Mask Offset

```
[ :SENSE ] :PVTime:MASK:LIST:TIME <seconds>{, <seconds>}
```

```
[ :SENSe ] :PVTime:MASK:LIST:TIME?
```

Define the mask start points.

Factory Preset: -667.0 μ s, -25.0 μ s, 25.0 μ s, 1308.0 μ s, 1358.0 μ s

Range: -10 to 10 ms

Remarks: You must be in W-CDMA mode to use this command.
Use INSTRument:SElect to set the mode.

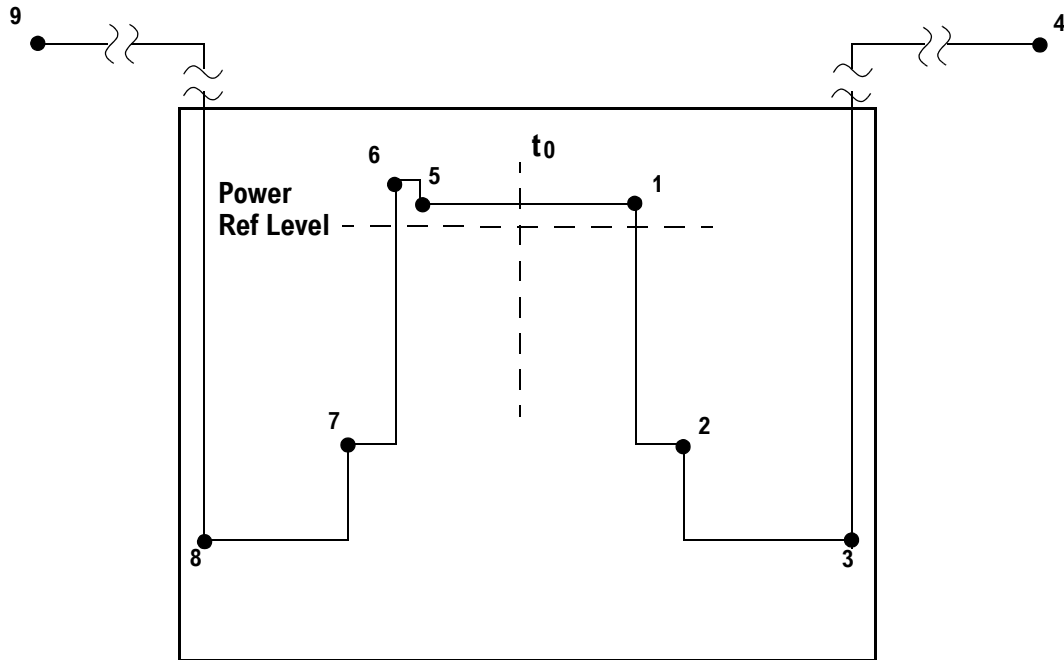
Power vs. Time—Upper Mask Relative Amplitude Levels

```
[ :SENSE ] :PVTime:MASK:LIST:UPPer:RELative <rel_power>,  
<rel_power>, <rel_power>, <rel_power>
```

```
[ :SENSe ] :PVTime:MASK:LIST:UPPer:RELative?
```

Enter the relative power level for each horizontal line segment in the upper limit mask. There should be a power level for each time point entered using [:SENSE] :PVTime:MASK:LIST:UPPer:TIME, and they must be entered in the same order. These power levels are all relative to the defined Reference Power Level (the average power in the useful part of the data). When an upper and lower limit masks have been defined, the Reference Power Level is the mid-point between these two limits at time t_0 . See [Figure 6-3 on page 919](#).

Figure 6-3 Custom Upper Limit Mask Example



Entered Value for each Time Segment	Absolute Time Value	Relative Power (example with Ref Level = -12 dBm)		Entered Absolute Power (dBm)	Segment Number
		Entered Relative Power	Equivalent Absolute Power		
280.0e-6	280 μ s	+4 dBc	-8 dBm	-200 dBm	1
15.0e-6	295 μ s	-32 dBc	-44 dBm	-200 dBm	2
450.0e-6	745 μ s	-48 dBc	-60 dBm ^a	-58 dBm ^a	3
1	>1 sec	+100 dBc	+88 dBm	-200 dBm	4
-270.0e-6	-270 μ s	+4 dBc	-8 dBm	-200 dBm	5
-10.0e-6	-280 μ s	+7 dBc	-5 dBm	-200 dBm	6
-20.0e-6	-300 μ s	-25 dBc	-37 dBm	-200 dBm	7
-450e-6	-750 μ s	-43 dBc	-55 dBm	-58 dBm	8
-1	<-1 sec	+100 dBc	+88 dBm	-200 dBm	9

a. Notice that this segment, with this value of Ref Level, has a calculated relative level of -60 dBm. This is lower than the specified absolute level of -58 dBm, so the -58 dBm value will be used as the test limit for the segment.

Example: PVT:MASK:LIST:UPP:REL
4, -32, -48, 100, 4, 7, -25, -43, 100

Factory Preset: Selected standard
-7.0, 2.5, 2.5, 2.5, and 7.5 dB for 1xEV-DO
-40.0 dB, 2.0 dB, 1.0 dB, 2.0 dB, -40.0 dB for W-CDMA

Range: -100 to +200 dB relative to the reference power

Default Unit: dB

Remarks: You must be in GSM, EDGE, 1xEV-DO, iDEN, WiDEN or W-CDMA mode to use this command. Use INSTRUMENT:SElect to set the mode.

History: E4406A: Added in revision A.03.00

Power vs. Time—Mask Upper Limit Test Mode

[[:SENSE]:PVTime:MASK:LIST:UPPer:TEST RELative|NONE, RELative|NONE, RELative|NONE, RELative|NONE

[[:SENSE]:PVTime:MASK:LIST:UPPer:TEST?

Set to the upper limit test mode.

Factory Preset: RELative, RELative, RELative, RELative, RELative

Range: Only RELative is currently available.

Remarks: You must be in 1xEV-DO or W-CDMA mode to use this command. Use INSTRUMENT:SElect to set the mode.

History: PSA: Added in version A.02.00
E4406A: Added in version A.05.00

Power vs. Time—Mask Reference Point

```
[ :SENSe ] :PVTIme:MASK:REFEreNce TRIGger |RISE |CENTer
```

```
[ :SENSe ] :PVTIme:MASK:REFEreNce?
```

Define the reference point of the mask timing.

TRIGger - Set to the trigger point.

RISE - Set to the rising edge of the burst determined after acquisition process.

CENTer - Set to the center between the rising and falling edges of the burst determined after acquisition process

Factory Preset: CENTer

RISE for W-CDMA

Remarks: You must be in 1xEV-DO or W-CDMA mode to use this command. Use INSTRument:SELEct to set the mode.

History: PSA: Added in version A.02.00

E4406A: Added in version A.05.00

Power vs. Time—Mask Reference Point Offset

```
[ :SENSe ] :PVTIme:MASK:REFEreNce [ :OFFSet ] :TIME <time>
```

```
[ :SENSe ] :PVTIme:MASK:REFEreNce [ :OFFSet ] :TIME?
```

Define the time offset of the mask timing reference. This is an advanced control that normally does not need to be changed.

Factory Preset: 0 s

Range: -10 to +10 ms

Remarks: You must be in 1xEV-DO or W-CDMA mode to use this command. Use INSTRument:SELEct to set the mode.

History: PSA: Added in version A.02.00

E4406A: Added in version A.05.00

Power vs. Time—Trigger Source

```
[[:SENSE]:PVTime:TRIGger:SOURce EXTERNAL [1] | EXTERNAL2  
| FRAME | LINE | IF | IMMEDIATE | RFBURST
```

```
[[:SENSE]:PVTime:TRIGger:SOURce?
```

Select the trigger source used to control the data acquisitions.

EXTERNAL 1 - front-panel external trigger input

EXTERNAL 2 - rear-panel external trigger input

FRAME - uses the internal frame timer, which has been synchronized to the selected burst sync.

IF - internal IF envelope (video) trigger

LINE - internal power line frequency trigger

IMMEDIATE - the next data acquisition is immediately taken, capturing the signal asynchronously (also called Free Run).

RFBURST - wideband RF burst envelope trigger that has automatic level control for periodic burst signals.

Factory Preset: RFBURST if the RF Communications Hardware (option B7E) has been installed

EXTERNAL, if option B7E has not been installed

FRAME for 1xEV-DO

IF envelope (video) (iDEN, WiDEN)

Remarks: You must be in GSM, EDGE, Service, 1xEV-DO, iDen, WiDEN, or W-CDMA mode to use this command. Use INSTRUMENT:SELEct to set the mode.

Radio Standards Commands

HSDPA/HSUPA Enable

```
[ :SENSE ] :RADio:CONFiGure:HSDPa [ :STATe ] OFF | ON | 0 | 1
```

```
[ :SENSE ] :RADio:CONFiGure:HSDPa [ :STATe ] ?
```

Example	:SENSE:RADio:CONFiGure:HSDPa:STATe OFF
Notes	This softkey is active if W-CDMA HSDPA/HSUPA option (Option 210) license is installed. This softkey is inactive (grayed out) if W-CDMA HSDPA/HSUPA option (Option 210) license is not installed.
Dependencies and Couplings	No Coupling.
Remote Command Notes	The SCPI command is available if W-CDMA HSDPA/HSUPA option (Option 210) license is installed.
Preset	ON
State Saved	Saved in instrument state.
Range	Off On
Key Path	Mode Setup, Demod, ENABLE HSDPA/HSUPA RUI operation

Radio Device Under Test

```
[[:SENSE]:RADio:DEvice BTS|MS
```

```
[[:SENSe]:RADio:DEvice?
```

Select the type of radio device to be tested.

BTS - Base station transmitter test

MS - Mobile station transmitter test

Factory Preset: BTS

Remarks: Global to the current mode.

You must be in cdma2000, GSM, EDGE, W-CDMA or 1xEV-DO mode to use this command. Use INSTRUMENT:SELEct to set the mode.

History: E4406A:
Version A.03.00 or later

Key Path: **Mode Setup, Radio, Device**

Modulation Accuracy (Rho) Measurement

Commands for querying the rho measurement results and for setting to the default values are found in the “[MEASure Group of Commands](#)” on [page 519](#). The equivalent front-panel keys for the parameters described in the following commands, are found under the **Meas Setup** key, after the **Mod Accuracy (Rho)** or **Mod Accuracy (Composite Rho)** measurement has been selected from the **MEASURE** key menu.

Modulation Accuracy (Rho)—ADC Range

12-bit ADC E4406A

```
[ :SENSe] :RHO:ADC:RANGe
AUTO | APEak | APLock | NONE | M6 | P0 | P6 | P12 | P18 | P24
```

PSA and 14-bit ADC E4406A

```
[ :SENSe] :RHO:ADC:RANGe AUTO | APEak | APLock | NONE | P0 | P6 | P12 | P18
[ :SENSe] :RHO:ADC:RANGe?
```

Select a ranging function for the ADC gain control. This is an advanced control that normally does not need to be changed. If you are measuring a CW signal, see the following description:

- AUTO - automatic ranging

For FFT spectrums, the auto ranging should not be used. An exception to this would be if you know that your signal is “bursty”. Then you might use auto to maximize the time domain dynamic range as long as you are not very interested in the FFT data.

- APEak (Auto Peak) - automatic ranging to the peak signal level

For CW signals, the default of auto-peak ranging can be used, but a better FFT measurement of the signal can be made by selecting one of the manual ranges that is available by specifying M6, or P0 through P24.

Auto peaking can cause the ADC gain to monotonically track the ranges down during the data capture. This tracking effect should be negligible for the FFT spectrum, but selecting a manual range solves this possibility. Note that if the CW signal being measured is close to the auto-ranging threshold, the noise floor may shift as much as 6 dB every sweep.

- APLOCK (Auto Peak Lock) - automatic ranging locked to the peak signal level

For CW signals, auto-peak lock ranging may be used. It will find the ADC gain most appropriate for this particular signal and will not track the ranges as auto-peak can. Note that if the CW signal being measured is close to the auto-ranging threshold, the noise floor may shift as much as 6 dB every sweep.

For “bursty” signals, auto-peak lock ranging should not be used. Since the ADC range can often be locked to the wrong one resulting in overloading the ADC, the measurement will fail.

- NONE - turns off any auto-ranging without making any changes to the current setting.
- M6 - manually selects an ADC range that subtracts 6 dB from the fixed gain across the range. Manual ranging is best for CW signals.
- P0 thru P24 - manually selects one of the ADC ranges that add 0 dB to 24 dB to the fixed gain across the range. Manual ranging is best for CW signals.

Factory Preset: M6

Remarks: You must be in the 1xEV-DO mode to use this command. Use INSTRUMENT:SElect to set the mode.

Modulation Accuracy (Rho)—Demod Alpha

`[[:SENSe]:RHO:ALPHa <numeric>`

`[[:SENSe]:RHO:ALPHa?`

Allows you to specify the alpha value of the Root Raised Cosine(RRC) filter.

Example	<code>:SENSe:RHO:ALPHa 0.22</code>
State Saved	Saved in instrument state.
Range	For all PSA and VSA with 14bit ADC, the available choices are: Auto Auto Peak AutoPeakLock None 0dB +6dB +12dB +18dB and the preset/default value is None (NONE). For VSA with 12bit ADC, the available choices are: Auto Auto Peak AutoPeakLock -6dB 0dB +6dB +12dB +18dB +24dB and the preset/default value is -6dB (M6).
Key Path	Meas Setup, More, More, Advanced
Remarks:	You must be in the W-CDMA mode to use this command. Use <code>INSTRument:SElect</code> to set the mode.

Modulation Accuracy (Rho)—Average Count

`[:SENSE] :RHO:AVERAge:COUNT <integer>`

`[:SENSe] :RHO:AVERAge:COUNT?`

Set the number of data acquisitions that will be averaged. After the specified number of averaging counts, the averaging mode (termination control) setting determines the averaging action.

Notes	Min:1, Max:10000
Remote Command	Turn averaging on or off.
Notes	
Preset	10, , ON
State Saved	Saved in instrument state.
SCPI Resolution	1
Key Path	Meas Setup
Range:	1 to 10,000
Remarks:	You must be in the cdmaOne, cdma2000, W-CDMA, or 1xEV-DO mode to use this command. Use INSTRument:SElect to set the mode.

Modulation Accuracy (Rho)—Averaging State

`[:SENSE] :RHO:AVERAge [:STATe] OFF | ON | 0 | 1`

`[:SENSe] :RHO:AVERAge [:STATe] ?`

Turn the modulation accuracy averaging function on or off.

Factory Preset: OFF

ON for cdma2000, W-CDMA, 1xEV-DO

Remarks: You must be in the cdmaOne, cdma2000, W-CDMA, or 1xEV-DO mode to use this command. Use INSTRument:SElect to set the mode.

Modulation Accuracy (Rho)—Averaging Termination Control

```
[ :SENSe] :RHO:AVERAge:TCONtrol EXPOnential | REPeat
```

```
[ :SENSe] :RHO:AVERAge:TCONtrol?
```

Select the type of termination control used for the averaging function. This determines the averaging action after the specified number of frames (average count) is reached.

EXPOnential - Each successive data acquisition after the average count is reached, is exponentially weighted and combined with the existing average.

REPeat - After reaching the average count, the averaging is reset and a new average is started.

Preset	REPeat
State Saved	Saved in instrument state.
Range	Exp Repeat
Key Path	Meas Setup
Remarks:	You must be in the cdmaOne, cdma2000, W-CDMA, or 1xEV-DO mode to use this command. Use INSTRument:SElect to set the mode.

Modulation Accuracy (RHO)- Capture Interval

```
[ :SENSe] :RHO:CAPTure:TIME <time>
```

```
[ :SENSe] :RHO:CAPTure:TIME?
```

Notes	The input value is rounded up to the nearest one in the followings. 0.067, 0.2, 1.0 (0.67 ; 1/15 frame equals 1 slot, and 0.2 ; 3/15 frame equals 3 slots).
Preset	1.0
State Saved	Saved in instrument state.
Range	0.067 0.2 1.0

Modulation Accuracy (Rho)—Chip Rate

`[:SENSe] :RHO:CRATe <freq>`

`[:SENSe] :RHO:CRATe?`

Allows you to change the chip rate.

Notes	Min:3.456MHz, Max:4.224MHz, SCPI Resolution:1.0kHz
Preset	3.84 MHz
State Saved	Saved in instrument state.
Key Path	Meas Setup, More, More, Advanced
Front-panel Unit/Terminator Keys	Hz kHz MHz GHz
Unit/Terminator Keys	Hz kHz MHz GHz
Range:	1.10592 to 1.35168 MHz for cdma2000, 1xEV-DO 3.456 to 4.224 MHz for W-CDMA
Default Unit:	Hz
Remarks:	You must be in the cdma2000, W-CDMA, or 1xEV-DO mode to use this command. Use INSTRument:SElect to set the mode.

Modulation Accuracy (RHO)—Frequency Error Tolerance Range

`[:SENSe] :RHO:FERRor:TRANge WIDE|NORMal`

`[:SENSe] :RHO:FERRor:TRANge?`

Frequency error tolerance range is specified:

- - Normal
- - Wide

‘Wide’ provides a wider, or more loose, range of frequency error tolerance. To correctly demodulate signals of higher complexity, a more stringent frequency tolerance is required. For example, when composite channels are modulated on the same signal, the modulation is complex, and frequency error is critical to correct demodulation. In the case of demodulating complex signals, set to ‘Normal’.

This parameter is valid only when the device type is ‘MS’(Uplink). When ‘BTS’ is set to (Downlink), MUI is disabled(grayed out).

Dependencies and Couplings	No
Preset	NORMal
State Saved	Saved in instrument state.
Range	WIDE NORMal
Key Path	Meas Setup, More, More, Advanced, More

Modulation Accuracy (Rho)—Multi Carrier Estimator

`[[:SENSe]:RHO:MCEstimator OFF|ON|0|1`

`[[:SENSe]:RHO:MCEstimator?`

Turns the multi carrier estimator on or off.

OFF - computes the phase information only from one coded signal assuming that each code phase is perfectly aligned.

ON - aligns the code phases to be orthogonal before computing the phase information.

Preset	OFF
State Saved	Saved in instrument state.
Range	On Off
Key Path	Meas Setup, More, More, Advanced, More

Remarks: You must be in the cdma2000, W-CDMA, or 1xEV-DO mode to use this command. Use INSTRument:SElect to set the mode.

Modulation Accuracy (Rho)—MICH Code Number [BTS only]

`[:SENSE] :RHO:MICH:SPRead <integer>`

`[:SENSE] :RHO:MICH:SPRead?`

`[:SENSE] :RHO:MICH:STATE OFF | ON | 0 | 1`

`[:SENSE] :RHO:MICH:STATE?`

Allows you to specify the code number of MICH (MBMS Indicator channel), which has the DTX (no transmission) part. MICH has 300 bits in 1 radio frame, but last 6 symbols (12 bits) are not transmitted. Therefore, MICH needs the special handling to measure the code domain power. MICH Code Number specifies which code channel should be considered as MICH. Since MICH is optional channel, the parameter can be enabled or disabled (On | Off).

Example	<code>:SENSE:RHO:MICH:SPRead 4</code> <code>:SENSE:RHO:MICH:STATE ON</code>
Notes	(1) If PICH Code Number and MICH Code Number are the same, the channel is considered as PICH. (2) This parameter is active for BTS. It is grayed out for MS. (3) This parameter is meaningful only if Symbol Boundary setting is Auto.
Remote Command Notes	This parameter enables or disables MICH code number setting.
Preset	2, , Off
State Saved	Saved in instrument state.
Range	2 – 255
Key Path	Meas Setup, More, More, Advanced, More

Modulation Accuracy (RHO)—Timing Estimation

`[:SENSe] :RHO:MCEstimator:TIMing CHANnel | GLOBal`

`[:SENSe] :RHO:MCEstimator:TIMing?`

Allows you to select timing estimation function by MMSE between channel-by-channel and global.

Channel-by-Channel - The code channels are estimated using individual channel timing. This takes longer.

Global : The individual code channels are estimated using global timing.

Preset	GLOBal
State Saved	Saved in instrument state.
Range	CHANnel GLOBal
Key Path	Meas Setup, More, More, Advanced, More

Modulation Accuracy (RHO)—PICH Code Number

`[:SENSE] :RHO:PICH:SPRead <integer>`

`[:SENSe] :RHO:PICH:SPRead?`

It specifies the code number of PICH, which has the DTX(no transmission) part. PICH has 300 bits in 1 radio frame, but last 12 bits are not transmitted. Then, PICH needs the special handling to measure the code domain power. PICH Code Number allows to specify which code channel should be as PICH.

NOTE

Active ID auto-detection is done by the algorithm regardless of this parameter. However, the result could be 7.5ksps channel if PICH's two consecutive demod bits are the same. This UI forces such 7.5ksps channels to be 15ksps channels.

Example	<code>:SENSe:RHO:PICH:SPRead 16</code>
Notes	(1) If PICH Code Number and MICH Code Number are the same, the channel is considered as PICH. (2) This parameter is active for BTS. It is grayed out for MS. (3) This parameter is meaningful only if Symbol Boundary setting is Auto.
Preset	16
State Saved	Saved in instrument state.
Range	2 – 255
Key Path	Meas Setup, More, More, Advanced, More

Modulation Accuracy (Rho)—PRACH Preamble Signature

`[[:SENSe]:RHO:PRACH:SIGNature <integer>`

`[[:SENSe]:RHO:PRACH:SIGNature?`

Set Signature number for PRACH Preamble detection, when `[[:SENSe]:RHO:PRACH:SIGNature:AUTO` is set to OFF. This value is set at its auto number if PRACH Preamble Signature Auto mode is set to ON.

Factory Preset: 0

Range: 0 to 15

Remarks: You must be in the W-CDMA mode to use this command. Use `INSTRument:SElect` to set the mode.

Modulation Accuracy (Rho)—Symbol Boundary Custom Active Channel List MS

This command creates the list of custom predefined channels for MS.

1st parameter:

INIT	This choice clears the current custom predefined active channel list. Then it creates a new entry with the given parameter.
APPend	This choice adds a new entry to the end of the list.
<entry_id>	This choice replaces an entry specified with <entry_id>. If used for query, it specifies the entry ID to be queried. (Entry ID: 1, 2, ..., the total number of entries in the list)

2nd parameter:

<symbol_rate> This parameter specifies symbol rate of the channel.

3rd parameter:

<code_num> This parameter specifies spreading code of the channel.

4th parameter:

IPH Specifies the channel is on I-axis.

QPH Specifies the channel is on Q-axis.

Mode WCDMA

Remote Command `[:SENSe] :RHO:SBOundary:LIST:MS
INIT|APPend|<entry_id>, <symbol_rate>,
<code_num>, IPH|QPH
[:SENSe] :RHO:SBOundary:LIST:MS?
<entry_id>`

Example In order to predefine the following channels:
- DPCCH (C8(0):Q)
- DPDCH (C6(16):I)

```
:SENSe:RHO:SBOundary:LIST:MS INIT, 15000,  
0, QPH
```

```
:SENSe:RHO:SBOundary:LIST:MS APPend,  
60000, 16, IPH
```

```
:SENSe:RHO:SBOundary:LIST:NCHannels:MS?  
2
```

```
:SENSe:RHO:SBOundary:LIST:MS? 1  
15000, 0, QPH
```

```
:SENSe:RHO:SBOundary:LIST:MS? 2  
60000, 16, IPH
```

Notes	<p>(1) This command is effective when [:SENSe]:RADio:DEVIce is set to MS and [:SENSe]:RHO:SBOundary:MS is set to CUSTom.</p> <p>(2) symbol_rate = 1920000 is available if HSDPA/HSUPA Enable is On.</p> <p>(3) The maximum number of entries is 512.</p>
Remote Command Notes	<p>Default value of the parameter</p> <p>By default, there is one channel defined. (DPCCH C8(0):Q)In order to query the default entry, specify 1 for <entry_id>:</p> <pre>:SENSe:RHO:SBOundary:LIST:MS? 1</pre> <p>The instrument will return an array of three values:15000, 0, QPH</p> <p>Query command needs <entry_id> parameter <entry_id> parameter is always required for query command.The range of the parameter is from 1 to the total number of channels you have defined. For example, if you have defined two channels, you can query them as follows:</p> <pre>:SENSe:RHO:SBOundary:LIST:MS? 1 :SENSe:RHO:SBOundary:LIST:MS? 2</pre> <p>If you want to know the number of channels you have defined, send the following query command: :SENSe:RHO:SBOundary:LIST:NCHannels:MS? One of the following error messages will be logged if the given parameter is invalid. If error is reported, the SCPI command is rejected and instrument's settings does not change.</p> <p>(1) "Missing Parameter" (PSA: -109, E4406A VSA: -109) This error is reported if the number of parameters is less than 4</p> <p>For example:</p> <pre>:SENSe:RHO:SBOundary:LIST:MS APPend, 15000, 0 3 4th parameter is missing.</pre> <p>(2) "Illegal parameter value" (PSA: -224, E4406A VSA: -224) This error is reported if parameter type is invalid or if enum value is invalid.</p>

Remote Command
 Notes (continued)

For example:

:SENSe:RHO:SBOundary:LIST:MS APPend,
 15000, ON, QPH β 3rd parameter must be integer.

:SENSe:RHO:SBOundary:LIST:MS DEL, 15000,
 0, QPH β 1st enum value is undefined.

:SENSe:RHO:SBOundary:LIST:MS APPend,
 15001, 0, QPH β 2nd parameter value (Symbol
 Rate) is not allowed.

:SENSe:RHO:SBOundary:LIST:MS APPend,
 15000, 256, QPH β 3rd parameter is out of range.

Only the values given in Range field are valid for
 the Symbol Rate. You may specify these in
 numeric form, but they are interpreted as an
 enumeration and the error will result if the value
 does not translate to one in the list.

(3) “Data out of range” (PSA: -222, E4406A VSA:
 -222)

This error is reported if parameter value is out
 of range.

e.g.

:SENSe:RHO:SBOundary:LIST:MS APPend,
 15000, 256, QPH β 3rd parameter is out of range.

(4) “Setting Conflict” (PSA: -221, E4406A VSA:
 -221)

This error is reported if the given code channel
 overlaps other code channel on code domain.

e.g.

If a user sends the following two commands, the
 second command causes the error message
 because C7(0):Q overlaps C8(0):Q.

:SENSe:RHO:SBOundary:LIST:MS INIT, 15000,
 0, QPH β OK

:SENSe:RHO:SBOundary:LIST:MS APPend,
 30000, 0, QPH β C7(0):Q overlaps C8(0):Q

Preset

15000, 0, QPH

State Saved

Saved in instrument state.

Range	<p>1 <= entry_id <= the number of channels already defined <= 512</p> <p>(<entry_id> is an integer ranging from 1 to 512.)</p> <p>symbol_rate = 15000 30000 60000 120000 240000 480000 960000 1920000</p> <p>0 <= code_num <= 255 if symbol_rate = 15000</p> <p>0 <= code_num <= 127 if symbol_rate = 30000</p> <p>0 <= code_num <= 63 if symbol_rate = 60000</p> <p>0 <= code_num <= 31 if symbol_rate = 120000</p> <p>0 <= code_num <= 15 if symbol_rate = 240000</p> <p>0 <= code_num <= 7 if symbol_rate = 480000</p> <p>0 <= code_num <= 3 if symbol_rate = 960000</p> <p>0 <= code_num <= 1 if symbol_rate = 1920000</p>
Key Path	<p>no support (SCPI only), Symbol Boundary Custom Active Channel List MS [MS only]</p>
History	<p>PSA A.09 and E4406A VSA A.10 and later versions support this parameter.</p>

Modulation Accuracy (Rho)—Symbol Boundary Custom Active Channel List – The Number Of Entries MS [MS only]

[[:SENSE]:RHO:SBOundary:LIST:MS:NCHannels?

This query-only command returns the number of entries in the custom predefined active channel list MS.

Example	:SENSe:RHO:SBOundary:LIST:MS:NCHannels?
Notes	This command is effective when [:SENSE]:RADio:DEVice is set to MS and [:SENSE]:RHO:SBOundary:MS is set to CUSTom.
Remote Command Notes	This command is a query-only command.
Preset	1
State Saved	No
Key Path	no support (SCPI only), Symbol Boundary Custom Active Channel List – The Number Of Entries MS [MS only]
History	PSA A.09 and E4406A VSA A.10 and later versions support this parameter.

Modulation Accuracy (Rho)—Symbol Boundary Custom Active Channel List – Load Preset Setting BTS [BTS only]

```
[ :SENSe] :RHO:SBOundary [:BTS]
AUTO | TM1D16 | TM1D32 | TM1D64 | TM1D16SC | TM1D32SC
| TM1D64SC | TM2 | TM2SC | TM3D16 | TM3D32 | TM3D16SC
| TM3D32SC | TM4 | TM4CP | TM5H2 | TM5H4 | TM5H8 | CUSTom
```

```
[ :SENSe] :RHO:SBOundary [:BTS] ?
```

This command-only command loads preset setting to the custom active channel list BTS.

Type	Number of Channels	Fraction of Power (%)	Level setting (dB)	Channelization Code	Timing offset (x256Tchip)
P-CCPCH+ SCH	1	7.9	-11	1	0
Primary CPICH	1	7.9	-11	0	0
PICH	1	1.3	-19	16	120
S-CCPCH containing PCH (SF=256)	1	1.3	-19	3	0
DPCH (SF=128)	30/14/6(*)	14/14.2/14.4 in total	see table 6.b	see table 6.b	see table 6.b
HS-SCCH	2	4 in total	see table 6.c	see table 6.c	see table 6.c
HS-PDSC H (16QAM)	8/4/2(*)	63.6/63.4/63.2 in total	see table 6.d	see table 6.d	see table 6.d
Note *:2 HS-PDSCH shall be taken together with 6 DPCH, 4 HS-PDSCH shall be taken with 14 DPCH, and 8 HS-PDSCH shall be taken together with 30 DPCH.					

Example	:SENSe:RHO:SBOundary:BTS TM1D16
Notes	This command is effective when [:SENSe]:RADio:DEvice is set to BTS.
Dependencies and Couplings	This softkey is active if “Radio Device” selection is “BTS”. If the “Radio Device” selection is “MS”, a different softkey (Symbol Boundary MS) appears instead of this softkey.
Remote Command Notes	The reason that TM5H2, TM5H4 and TM5H8 have been selected is to align the enumerations with those of ESG’s. W-CDMA HSDPA option license is necessary to make these three parameters for test model 5 available. In addition, you need to enable W-CDMA HSDPA option functionality. Otherwise, this parameter is not available --- Test Model 5 softkey is inactive (grayed out) and SCPI commands for Test Model 5 do not have effect.
Preset	AUTO
State Saved	Saved in instrument state.
Range	Auto Test Model 1 w/ 16 DPCH w/ S_CCPCH Test Model 1 w/ 32 DPCH w/ S_CCPCH Test Model 1 w/ 64 DPCH w/ S_CCPCH Test Model 1 w/ 16 DPCH Test Model 1 w/ 32 DPCH Test Model 1 w/ 64 DPCH Test Model 2 w/ S_CCPCH Test Model 2 Test Model 3 w/ 16 DPCH w/ S_CCPCH Test Model 3 w/ 32 DPCH w/ S_CCPCH Test Model 3 w/ 16 DPCH Test Model 3 w/ 32 DPCH Test Model 4 w/ P-CPICH Test Model 4 Test Model 5 w/ 2 HS-PDSCH w/ 6 DPCH Test Model 5 w/ 4 HS-PDSCH w/ 14 DPCH Test Model 5 w/ 8 HS-PDSCH w/ 30 DPCH Custom
Key Path	Meas Setup, More

Modulation Accuracy (Rho)—Symbol Boundary Custom Active Channel List BTS

```
[ :SENSe] :RHO:SBoundary:LIST[:BTS]:INIT  
<symbol_rate>,<code_num>, QPSK|QAM16
```

```
[ :SENSe] :RHO:SBoundary:LIST[:BTS]:APPend <symbol_rate>,  
<code_num>, QPSK|QAM16
```

```
[ :SENSe] :RHO:SBoundary:LIST[:BTS]:REPLace <entry_id>,  
<symbol_rate>, <code_num>, QPSK|QAM16
```

```
[ :SENSe] :RHO:SBoundary:LIST[:BTS]:CHANnel? <entry_id>
```

This command creates the list of custom predefined channels for BTS.

1st parameter:

INIT	This choice clears the current custom predefined active channel list. Then it creates a new entry with the given parameter.
APPend	This choice adds a new entry to the end of the list.
<entry_id>	This choice replaces an entry specified with <entry_id>. If used for query, it specifies the entry ID to be queried. (Entry ID:1, 2, ..., the total number of entries in the list)

2nd parameter:

<symbol_rate> This parameter specifies symbol rate of the channel.

3rd parameter:

<code_num> This parameter specifies code number of the channel.

4th parameter:

QPSK	Specifies the channel's modulation scheme is QPSK.
QAM16	Specifies the channel's modulation scheme is QAM16. This choice is available only for channels with symbol rate 240000.

Remote Command
 Notes

Error messages associated with this parameter.

One of the following error messages will be logged if the given parameter is invalid.

If error is reported, the SCPI command is rejected and instrument's settings do not change.

(1) "Missing Parameter" (PSA: -109, E4406A VSA: -109) This error is reported if the number of parameters is less than 3.

For example:

```
:SENSe:RHO:SBOundary:LIST:BTS:INIT,
15000, 0 ? 3rd parameter is missing.
```

(2) "Illegal parameter value" (PSA: -224, E4406A VSA: -224) This error is reported if parameter type is invalid or if enum value is invalid.

For example:

```
:SENSe:RHO:SBOundary:LIST:BTS:INIT,
15000, ON, QPSK ? 2nd parameter must be
integer.
:SENSe:RHO:SBOundary:LIST:BTS:INIT 15001,
8, QPSK ? 1st parameter value (Symbol Rate) is
not allowed.
```

Only the values given in Range field are valid for the Symbol Rate. You may specify these in numeric form, but they are interpreted as an enumeration and the error will result if the value does not translate to one in the list.

(3) "Data out of range" (PSA: -222, E4406A VSA: -222) This error is reported if parameter value is out of range.

For example:

```
:SENSe:RHO:SBOundary:LIST:BTS:INIT 15000,
256, QPSK ? 2nd parameter is out of range.
```

(4) "Setting Conflict" (PSA: -221, E4406A VSA: -221) This error is reported if the given code channel overlaps other code channel on code domain.

For example:

If a user sends the following two commands, the second command causes the error message because C7(0) overlaps C8(0).

```
:SENSe:RHO:SBOundary:LIST:BTS:INIT 15000,
0, QPSK ? OK
:SENSe:RHO:SBOundary:LIST:BTS:APPend
30000, 0, QPSK ? C7(0) overlaps C8(0)
```

State Saved

Saved in instrument state.

Range	<p>symbol_rate = 7500 15000 30000 60000 120000 240000 480000 960000</p> <p>0<= code_num <= 511 if symbol_rate = 7500 0<= code_num <= 255 if symbol_rate = 15000 0<= code_num <= 127 if symbol_rate = 30000 0<= code_num <= 63 if symbol_rate = 60000 0<= code_num <= 31 if symbol_rate = 120000 0<= code_num <= 15 if symbol_rate = 240000 0<= code_num <= 7 if symbol_rate = 480000 0<= code_num <= 3 if symbol_rate = 960000</p> <p>QAM16 for the 3rd parameter is available only for channels with symbol rate 240000. For other channels, specify QPSK.</p>
Key Path	no support (SCPI only)

Modulation Accuracy (Rho)—Symbol Boundary Custom Active — The Number of Entries BTS [BTS only]

[:SENSe] :RHO:SBOundary:LIST [:BTS] :NCHannels?

This query-only command returns the number of entries in the custom predefined active channel list BTS.

Example	:SENSe:RHO:SBOundary:LIST:BTS:NCHannels?
Notes	<p>This command is effective when [:SENSe]:RADio:DEvice is set to BTS and [:SENSe]:RHO:SBOundary[:BTS] is set to CUSTom.</p>
Remote Command Notes	This command is a query-only command.
Preset	1
State Saved	No
Key Path	no support (SCPI only)

Modulation Accuracy (Rho)—Symbol Boundary Custom Active — Load Preset Setting BTS [BTS only]

```
[ :SENSe] :RHO:SBOundary:LIST[:BTS]:PRESet
TM1D16 | TM1D32 | TM1D64 | TM1D16SC | TM1D32SC | TM1D64SC | TM2 | TM2SC | T
M3D16 | TM3D32 | TM3D16SC | TM3D32SC | TM4 | TM4CP | TM5H2 | TM5H4 | TM5H8
```

This command-only command loads preset setting to the custom active channel list BTS.

Example :SENSe:RHO:SBOundary:LIST:BTS:PRESet
 TM1D64

Notes (1) This command is effective when [:SENSe]:RADio:DEvice is set to BTS and [:SENSe]:RHO:SBOundary[:BTS] is set to CUSTom.
 (2) TM5H2, TM5H4, TM5H8 parameters are allowed if HSDPA/HSUPA Enable is On.

Remote Command Notes This command is a command-only command.

State Saved No

Range TM1D16 | TM1D32 | TM1D64 | TM1D16SC | TM1D32SC | TM1D64SC | TM2 | TM2SC | TM3D16 | TM3D32 | TM3D16SC | TM3D32SC | TM4 | TM4CP | TM5H2 | TM5H4 | TM5H8

The meaning of above parameters are the same as those of Predefined Test Model provided in Slot Boundary Test Model in BTS

Key Path **no support (SCPI only)**

Modulation Accuracy (Rho)—Symbol Boundary Custom Active — The Number of Entries BTS [BTS only]

`[:SENSe] :RHO:SBOundary:LIST [:BTS] :NCHannels?`

This query-only command returns the number of entries in the custom predefined active channel list BTS.

Example	<code>:SENSe:RHO:SBOundary:LIST:BTS:NCHannels?</code>
Notes	This command is effective when <code>[:SENSe]:RADio:DEVIce</code> is set to <code>BTS</code> and <code>[:SENSe]:RHO:SBOundary[:BTS]</code> is set to <code>CUSTom</code> .
Remote Command Notes	This command is a query-only command.
Preset	1
State Saved	No
Key Path	no support (SCPI only)

Modulation Accuracy (Rho)—Symbol Boundary MS [MS only]

`[:SENSe] :RHO:SBOundary:MS AUTO | CUSTom`

`[:SENSe] :RHO:SBOundary:MS?`

Select the symbol boundary detection mode for MS.

Allows you to access the selection menu for the symbol boundary detection modes to specify active channel detection scheme on uplink.

Auto [SCPI Enum: AUTO] – Select this to set the symbol boundary detection to the automatic mode. Various code channels are measured and the most appropriate code channel is selected as the reference channel.

Custom [SCPI Enum: CUSTom] – “Custom” choice provides a flexible way to specify predefined active channels. By choosing it, you can specify a customized list of active channels by another SCPI command:

`[:SENSe]:RHO:SBOundary:LIST:MS INIT | APPend | <entry_id>, <symbol_rate>, <code_num>, IPH | QPH`

All the specified channels are considered as active.

There is no MUI (softkey) to specify custom active channel list.

NOTE

The “Custom” choice is selectable even if you have not sent the following SCPI command:
“[:SENSe]:RHO:SBOundary:LIST:MS”
because the default custom list contains DPCCH (15000, 0, QPH) as a predefined active channel. In other words, just simply choosing “Custom” setting will make one channel (C8(0):Q) considered as active, and all other channels considered as inactive.

Example	:SENSe:RHO:SBOundary:MS CUST
Notes	This parameter is effective when [:SENSe]:RADio:DEVice is set to MS.
Dependencies and Couplings	This softkey is active if “Radio Device” selection is “MS”. If the “Radio Device” selection is “BTS”, different softkey (Symbol Boundary BTS) appears instead of this softkey.
Preset	AUTO
State Saved	Saved in instrument state.
Range	Auto Custom
Key Path	Meas Setup, More

Modulation Accuracy (Rho)—Symbol Boundary MS Init [MS only]

```
[:SENSe]:RHO:SBOundary:LIST:MS:INIT <symbol_rate>,  
<code_num>, IPH|QPH
```

This initializes the the current custom active channel list. This creates a new entry with the given parameter.

1st parameter:

```
<symbol_rate> This parameter specifies symbol rate of the channel.  
>
```

2nd parameter:

```
<code_num> This parameter specifies spreading code of the channel.
```

3rd parameter:

IPH Specifies the channel is on I-axis.
QPH Specifies the channel is on Q-axis.

Example In order to predefine the following channels:
- DPCCH (C8(0):Q)
- DPDCH (C6(16):I)

```
:SENSe:RHO:SBOundary:LIST:MS:INIT 15000,  
0, QPH  
:SENSe:RHO:SBOundary:LIST:MS:APPend  
60000, 16, IPH
```

```
:SENSe:RHO:SBOundary:LIST:MS:NCHannels?  
2
```

```
:SENSe:RHO:SBOundary:LIST:MS:CHANnel? 1  
15000, 0, QPH
```

```
:SENSe:RHO:SBOundary:LIST:MS:CHANnel? 2  
60000, 16, IPH
```

Notes

- (1) This command is effective if
[:SENSe]:RADio:DEvice is set to MS and
[:SENSe]:RHO:SBOundary:MS is set to CUSTom.
- (2) symbol_rate = 1920000 is available if
HSDPA/HSUPA Enable is On.
- (3) The maximum number of entries is 512.

Remote Command
Notes

One of the following error messages will be logged if the given parameter is invalid.

If error is reported, the SCPI command is rejected and instrument's settings does not change.

(1) "Missing Parameter" (PSA: -109, E4406A VSA: -109) This error is reported if the number of parameters is less than 3.

For example:

```
:SENSe:RHO:SBOundary:LIST:MS:INIT 15000,0
? 3rd parameter is missing.
```

(2) "Illegal parameter value" (PSA: -224, E4406A VSA: -224) This error is reported if parameter type is invalid or if enum value is invalid.

For example:

```
:SENSe:RHO:SBOundary:LIST:MS:INIT 15000,
ON, QPH ? 2nd parameter must be integer.
:SENSe:RHO:SBOundary:LIST:MS:INIT 15001,
0, QPH ? 1st parameter value (Symbol Rate) is not
allowed.
```

Only the values given in Range field are valid for the Symbol Rate. You may specify these in numeric form, but they are interpreted as an enumeration and the error will result if the value does not translate to one in the list.

(3) "Data out of range" (PSA: -222, E4406A VSA: -222) This error is reported if parameter value is out of range.

For example:

```
:SENSe:RHO:SBOundary:LIST:MS:INIT 15000,
256, QPH ? 2nd parameter is out of range.
```

(4) "Setting Conflict" (PSA: -221, E4406A VSA: -221) This error is reported if the given code channel overlaps other code channel on code domain.

For example:

If a user sends the following two commands, the second command causes the error message because C7(0):Q overlaps C8(0):Q.

```
:SENSe:RHO:SBOundary:LIST:MS:INIT 15000,
0, QPH ? OK
:SENSe:RHO:SBOundary:LIST:MS:APPend
30000, 0, QPH ? C7(0):Q overlaps C8(0):Q
```

State Saved

Saved in instrument state.

Range	symbol_rate = 15000 30000 60000 120000 240000 480000 960000 1920000
	0<= code_num <= 255 if symbol_rate = 15000 0<= code_num <= 127 if symbol_rate = 30000 0<= code_num <= 63 if symbol_rate = 60000 0<= code_num <= 31 if symbol_rate = 120000 0<= code_num <= 15 if symbol_rate = 240000 0<= code_num <= 7 if symbol_rate = 480000 0<= code_num <= 3 if symbol_rate = 960000 0<= code_num <= 1 if symbol_rate = 1920000
Key Path	no support (SCPI only)

Modulation Accuracy (Rho)—Symbol Boundary MS Replace [MS only]

```
[[:SENSE]:RHO:SBOundary:LIST:MS:REPLace <entry_id>,  
<symbol_rate>, <code_num>, IPH|QPH
```

This command replaces the entry of the custom active channel list.

1st parameter:

<entry_id This parameter specifies entry ID of the channel to replace.
>

2nd parameter:

<symbol_r This parameter specifies symbol rate of the channel.
ate>

3rd parameter:

<code_nu This parameter specifies spreading code of the channel.
m>

4th parameter:

IPH Specifies the channel is on I-axis.
QPH Specifies the channel is on Q-axis.

Example In order to predefine the following channels:
- DPCCH (C8(0):Q)
- DPDCH (C6(16):I)

```
:SENSe:RHO:SBOundary:LIST:MS:INIT 15000,  
0, QPH  
:SENSe:RHO:SBOundary:LIST:MS:APPend  
60000, 16, IPH  
  
:SENSe:RHO:SBOundary:LIST:MS:NCHannels?  
2  
  
And, replace 2nd entry.  
:SENSe:RHO:SBOundary:LIST:MS:REPLace 2,  
60000,17,QPH  
  
:SENSe:RHO:SBOundary:LIST:MS:CHANnel? 1  
15000, 0, QPH  
:SENSe:RHO:SBOundary:LIST:MS:CHANnel? 2  
60000, 17, IPH
```

Notes (1) This command is effective if
[:SENSe]:RADio:DEvice is set to MS and
[:SENSe]:RHO:SBOundary:MS is set to CUSTom.
(2) symbol_rate = 1920000 is available if
HSDPA/HSUPA Enable is On.
(3) The maximum number of entries is 512.

Remote Command Notes	<p>One of the following error messages will be logged if the given parameter is invalid.</p> <p>If error is reported, the SCPI command is rejected and instrument's settings does not change.</p> <p>(1) "Missing Parameter" (PSA: -109, E4406A VSA: -109) This error is reported if the number of parameters is less than 3. For example: :SENSe:RHO:SBOundary:LIST:MS:INIT 15000,0 ? 3rd parameter is missing.</p> <p>(2) "Illegal parameter value" (PSA: -224, E4406A VSA: -224) This error is reported if parameter type is invalid or if enum value is invalid. For example: :SENSe:RHO:SBOundary:LIST:MS:INIT 15000, ON, QPH ? 2nd parameter must be integer. :SENSe:RHO:SBOundary:LIST:MS:INIT 15001, 0, QPH ? 1st parameter value (Symbol Rate) is not allowed. Only the values given in Range field are valid for the Symbol Rate. You may specify these in numeric form, but they are interpreted as an enumeration and the error will result if the value does not translate to one in the list.</p> <p>(3) "Data out of range" (PSA: -222, E4406A VSA: -222) This error is reported if parameter value is out of range. For example: :SENSe:RHO:SBOundary:LIST:MS:INIT 15000, 256, QPH ? 2nd parameter is out of range.</p> <p>(4) "Setting Conflict" (PSA: -221, E4406A VSA: -221) This error is reported if the given code channel overlaps other code channel on code domain. For example: If a user sends the following two commands, the second command causes the error message because C7(0):Q overlaps C8(0):Q.</p> <pre>:SENSe:RHO:SBOundary:LIST:MS:INIT 15000, 0, QPH ? OK :SENSe:RHO:SBOundary:LIST:MS:APPend 30000, 0, QPH ? C7(0):Q overlaps C8(0):Q</pre>
State Saved	<p>Saved in instrument state.</p>

Range

The entry ID must be:

1 <= entry_id <= The number of entries which have been defined. (See REF_Ref123467322 \r \h - Symbol Boundary Custom Active Channel List – The Number Of Entries MS [MS only])

symbol_rate = 15000 | 30000 | 60000 | 120000 | 240000 | 480000 | 960000 | 1920000

0 <= code_num <= 255 if symbol_rate = 15000

0 <= code_num <= 127 if symbol_rate = 30000

0 <= code_num <= 63 if symbol_rate = 60000

0 <= code_num <= 31 if symbol_rate = 120000

0 <= code_num <= 15 if symbol_rate = 240000

0 <= code_num <= 7 if symbol_rate = 480000

0 <= code_num <= 3 if symbol_rate = 960000

0 <= code_num <= 1 if symbol_rate = 1920000

Key Path

no support (SCPI only)

Modulation Accuracy (Rho)—Symbol Boundary MS Query [MS only]

```
[ :SENSe ] :RHO:SBOundary:LIST:MS:CHANnel? <entry_id>
```

This command returns the entry of the custom active channel list.

1st parameter:

<entry_id> This parameter specifies entry ID of the channel to query

Example In order to predefine the following channels:

- DPCCH (C8(0):Q)
- DPDCH (C6(16):I)


```
:SENSe:RHO:SBOundary:LIST:MS:INIT 15000,
0, QPH
:SENSe:RHO:SBOundary:LIST:MS:APPend
60000, 16, IPH

:SENSe:RHO:SBOundary:LIST:MS:NCHannels?
2

:SENSe:RHO:SBOundary:LIST:MS:CHANnel? 1
15000, 0, QPH

:SENSe:RHO:SBOundary:LIST:MS:CHANnel? 2
60000, 16, IPH
```

Notes

- (1) This command is effective if
[:SENSe]:RADio:DEVice is set to MS and
[:SENSe]:RHO:SBOundary:MS is set to CUSTom.
- (2) symbol_rate = 1920000 is available if
HSDPA/HSUPA Enable is On.
- (3) The maximum number of entries is 512.

Remote Command Notes	<p>Default value of the parameter</p> <p>By default, there is one channel defined. (DPCCH C8(0):Q) In order to query the default entry, specify 1 for <entry_id>: :SENSe:RHO:SBOundary:LIST:MS:CHANnel? 1 The instrument will return an array of three values: 15000, 0, QPH</p> <p>Query command needs <entry_id> parameter</p> <p><entry_id> parameter is always required for query command. The range of the parameter is from 1 to the total number of channels you have defined. For example, if you have defined two channels, you can query them as follows: :SENSe:RHO:SBOundary:LIST:MS:CHANnel? 1 :SENSe:RHO:SBOundary:LIST:MS:CHANnel? 2</p> <p>If you want to know the number of channels you have defined, send the following query command: :SENSe:RHO:SBOundary:LIST:MS:NCHannels?</p>
Preset	15000, 0, QPH
State Saved	Saved in instrument state.
Range	<p>The entry ID must be:</p> <p>1 <= entry_id <= The number of entries which have been defined. (See REF_Ref123467322 \r \h * MERGEFORMAT - Symbol Boundary Custom Active Channel List – The Number Of Entries MS [MS only])</p>
Key Path	no support (SCPI only)

Modulation Accuracy (Rho)—Symbol Boundary Custom Active Channel List MS Query [MS Only]

`[:SENSE] :RHO:SBoundary:LIST:MS:NChannels?`

This query-only command returns the number of entries in the custom predefined active channel list MS.

Example	<code>:SENSE:RHO:SBoundary:LIST:MS:NChannels?</code>
Notes	This command is effective when <code>[:SENSE]:RADio:DEvice</code> is set to MS and <code>[:SENSE]:RHO:SBoundary:MS</code> is set to CUSTom.
Remote Command Notes	This command is a query-only command.
Preset	1
State Saved	No
Key Path	no support (SCPI only)

Modulation Accuracy (Rho)—Symbol Boundary for BTS

Select the symbol boundary detection mode. This command is only available when the `[:SENSE]:RADio:DEvice` is set to BTS (base station testing). Also, Test Model 5 functionality is only available when you have a license for the HSDPA option.

`[:SENSE] :RHO:SBoundary [:BTS]`
AUTO | **TM1D16** | **TM1D32** | **TM1D64** | **TM2** | **TM3D16**
 | **TM3D32** | **TM4** | **TM4CP** | **TM1D16SC** | **TM1D32SC** | **TM1D64SC** | **TM2SC** | **TM3D16SC**
 | **TM3D32SC**
 | **TM5H2** | **TM5H4** | **TM5H8**

`[:SENSE] :RHO:SBoundary?`

Auto - sets the symbol boundary detection to the automatic mode. Various code channel are measured and the most appropriate code channel is determined as the reference channel.

TM1D16 - sets the code domain power measurement to Test Model 1 with 16 DPCH channels.

TM1D32 - sets the code domain power measurement to Test Model 1 with 32 DPCH channels.

TM1D64 - sets the code domain power measurement to Test Model 1 with 64 DPCH channels.

TM2 - sets the code domain power measurement to Test Model 2.

TM3D16 - sets the code domain power measurement to Test Model 3 with 16 DPCH channels.

TM3D32 - sets the code domain power measurement to Test Model 3 with 32 DPCH channels.

TM4 - sets the symbol boundary detection to Test Model 4 w/o Primary CCPCH channel.

TM4CP - sets the symbol boundary detection to Test Model 4 with Primary CCPCH channel.

TM1D16SC -sets the symbol boundary detection to Test Model 1 with 16 DPCH channels including S-CCPCH.

TM1D32SC -sets the symbol boundary detection to Test Model 1 with 32 DPCH channels including S-CCPCH.

TM1D64SC -sets the symbol boundary detection to Test Model 1 with 64 DPCH channels including S-CCPCH.

TM2SC -sets the symbol boundary detection to Test Model 2 with S-CCPCH channel.

TM3D16SC -sets the symbol boundary detection to Test Model 3 with 16 DPCH channels including S-CCPCH.

TM5H2 -sets the symbol boundary detection to Test Model 5 with 2 HS-PDSCH channels including 6 DPCH.

TM5H4 -sets the symbol boundary detection to Test Model 5 with 4 HS-PDSCH channels including 14 DPCH.

TM5H8 -sets the symbol boundary detection to Test Model 5 with 8 HS-PDSCH channels including 30 DPCH.

Example :SENSe:RHO:SBOundary:BTS TM1D16

Notes This command is effective when [:SENSe]:RADio:DEVice is set to BTS.

Dependencies and Couplings This softkey is active if “Radio Device” selection is “BTS”.
 If the “Radio Device” selection is “MS”, a different softkey (Symbol Bounday MS) appears instead of this softkey.

Remote Command Notes	The reason that TM5H2, TM5H4 and TM5H8 have been selected is to align the enumerations with those of ESG's. W-CDMA HSDPA option license is necessary to make these three parameters for test model 5 available. In addition, you need to enable W-CDMA HSDPA option functionality. Otherwise, this parameter is not available --- Test Model 5 softkey is inactive (grayed out) and SCPI commands for Test Model 5 do not have effect.
Preset	AUTO
State Saved	Saved in instrument state.
Range	Auto Test Model 1 w/ 16 DPCH w/ S_CCPCH Test Model 1 w/ 32 DPCH w/ S_CCPCH Test Model 1 w/ 64 DPCH w/ S_CCPCH Test Model 1 w/ 16 DPCH Test Model 1 w/ 32 DPCH Test Model 1 w/ 64 DPCH Test Model 2 w/ S_CCPCH Test Model 2 Test Model 3 w/ 16 DPCH w/ S_CCPCH Test Model 3 w/ 32 DPCH w/ S_CCPCH Test Model 3 w/ 16 DPCH Test Model 3 w/ 32 DPCH Test Model 4 w/ P-CPICH Test Model 4 Test Model 5 w/ 2 HS-PDSCH w/ 6 DPCH Test Model 5 w/ 4 HS-PDSCH w/ 14 DPCH Test Model 5 w/ 8 HS-PDSCH w/ 30 DPCH Custom
Key Path	Meas Setup, More, Test Model 5
History	PSA A.06 / E4406A VSA A.07 and later versions support Test Model 5 choices. PSA A.09 and E4406A VSA A.10 and later versions support this custom choice.

Pressing “Custom” softkey closes this sub menu and gets back to its parent menu (Meas Setup 2 of 2)

Type	Number of Channels	Fraction of Power (%)	Level setting (dB)	Channelization Code	Timing offset (x256Tchip)
PCCPCH+SCH	1	10	-10	1	0
Primary CPICH	1	10	-10	0	0
PICH	1	3.2	-15	16	120
DPCH (SF=128)	16/32/64	76.8 in total	see table 6.2	see table 6.2	see table 6.2

Type	Number of Channels	Fraction of Power (%)	Level setting (dB)	Channelization Code	Timing offset (x256Tchip)
P-CCPCH+SCH	1	10	-10	1	0
Primary CPICH	1	10	-10	0	0
PICH	1	1.6	-18	16	120
S-CCPCH containing PCH (SF=256)	1	1.6	-18	3	0
DPCH (SF=128)	16/32/64	76.8 in total	see table 6.2	see table 6.2	see table 6.2

Type	Number of Channels	Fraction of Power (%)	Level setting (dB)	Channelization Code	Timing offset (x256Tchip)
PCCPCH+SCH	1	10	-10	1	0
Primary CPICH	1	10	-10	0	0
PICH	1	10	-10	16	120
DPCH (SF=128)	3	2 x 10, 1 x 50	2 x -10, 1 x -3	24, 72, 120	1, 7, 2

Programming Commands
 Modulation Accuracy (Rho) Measurement

Type	Number of Channels	Fraction of Power (%)	Level setting (dB)	Channelization Code	Timing offset (x256Tchip)
P-CCPCH+SCH	1	10	-10	1	0
Primary CPICH	1	10	-10	0	0
PICH	1	5	-13	16	120
S-CCPCH containing PCH (SF=256)	1	5	-13	3	0
DPCH (SF=128)	3	2 x 10, 1 x 50	2 x -10, 1 x -3	24, 72, 120	1, 7, 2

Type	Number of Channels	Fraction of Power (%) 16/32	Level settings (dB) 16/32	Channelization Code	Timing offset (x256Tchip)
PCCPCH+SCH	1	12,6/7,9	-9 / -11	1	0
Primary CPICH	1	12,6/7,9	-9 / -11	0	0
PICH	1	10/3,2	-10 / -15	16	120
DPCH (SF=256)	16/32	63,7/80,4 in total	see table 6.5	see table 6.5	see table 6.5

Type	Number of Channels	Fraction of Power (%) 16/32	Level settings (dB) 16/32	Channelization Code	Timing offset (x256Tchip)
P-CCPCH+SCH	1	12,6/7,9	-9 / -11	1	0
Primary CPICH	1	12,6/7,9	-9 / -11	0	0
PICH	1	5/1.6	-13/-18	16	120
S-CCPCH containing PCH (SF=256)	1	5/1.6	-13/-18	3	0
DPCH (SF=256)	16/32	63,7/80,4 in total	see table 6.5	see table 6.5	see table 6.5

Type	Number of Channels	Fraction of Power (%)	Level setting (dB)	Channelization Code	Timing offset
PCCPCH+SCH	1	50 to 1.6	-3 to -18	1	0
Primary CPICH1	1	10	-10	0	0

Note 1: The CPICH channel is optional.

Type	Number of Channels	Fraction of Power (%)	Level setting (dB)	Channelization Code	Timing offset (x256Tchip)
P-CCPCH+SCH	1	7.9	-11	1	0
Primary CPICH	1	7.9	-11	0	0
PICH	1	1.3	-19	16	120
S-CCPCH containing PCH (SF=256)	1	1.3	-19	3	0
DPCH (SF=128)	30/14/6(*)	14/14.2/14.4 in total	see table 6.b	see table 6.b	see table 6.b
HS-SCCH	2	4 in total	see table 6.c	see table 6.c	see table 6.c
HS-PDSCH (16QAM)	8/4/2(*)	63.6/63.4/63.2 in total	see table 6.d	see table 6.d	see table 6.d

Note *: 2 HS-PDSCH shall be taken together with 6 DPCH, 4 HS-PDSCH shall be taken with 14 DPCH, and 8 HS-PDSCH shall be taken together with 30 DPCH.

Modulation Accuracy (Rho)—PRACH Preamble Signature Detection

`[[:SENSE]:RHO:PRACH:SIGNature <integer>`

`[[:SENSE]:RHO:PRACH:SIGNature?`

`[[:SENSE]:RHO:PRACH:SIGNature:AUTO OFF|ON|0|1`

`[[:SENSE]:RHO:PRACH:SIGNature:AUTO?`

Set PRACH Preamble Signature number for PRACH Message detection. Based on this value, the code allocation of PRACH message control part is calculated. This command is effective when the `[[:SENSE]:RHO:SYNC:MS` command is set to `PMESsage` (PRACH Message).

PRACH message (Control) has only Slot Format #0. The field lengths are defined as the table below. Demod attribute information is colored according to the given Slot Format parameter. Using input parameter Slot Format #i, bit data is colored accordingly (e.g. Npilot and NTF CI).

Slot Format #i	Channel Bit Rate (kbps)	Channel Symbol Rate (ksps)	SF	Bits/ Frame	Bits/ Slot	Npilot	NTF CI
0	15	15	256	150	10	8	2

Select Auto or Man(Manual). Auto corresponds to “ON” for `[[:SENSE]:RHO:PRACH:SIGNature:AUTO` command.

When Auto is selected, it searches and synchronizes PRACH Message control part automatically. The code for control part is assigned according to PRACH Preamble Signature number. It can find the code number for control part from 16 possible cases. But it takes more time than manual setting. “---“ is shown initially.

When Man is selected, it synchronizes with the code specified by Preamble Signature.

The value is set at its auto number and “---“ is replaced with the detected number, if PRACH Search is set to Auto and PRACH Message sync is done (PRACH Message control part is detected) successfully. Otherwise the value is not changed.

NOTE

This function does not check “Preamble Signature” itself. Instead, using this information, it identifies the code location for PRACH Message control part. The relationship between “Preamble Signature” and “code location for PRACH Message control part” is one-to-one correspondence. (It is defined in 3GPP)

Notes	This command is effective when [:SENSe]:RADio:DEVice is set to MS, and [:SENSe]:RHO:SYNC:MS is set to PMESsage.
Remote Command Notes	Set Signature Auto mode ON for PRACH Preamble detection.
Preset	0, , ON
State Saved	Saved in instrument state.
SCPI Resolution	1
Key Path	Meas Setup, More

Remarks: You must be in the W-CDMA mode to use this command. Use INSTRument:SElect to set the mode.

Modulation Accuracy (Rho)—Slot Format [MS only]

[:SENSe] :RHO:SFORmat:MS SF0 | SF1 | SF2 | SF3 | SF4 | SF5 | AUTO

Select Slot Format for synchronization to the uplink DPCCH signal. This command is effective when the [:SENSe]:RHO:SYNC:MS command is set to DPCCh.

(PSA A.09 and E4406A VSA A.10) and later versions support automatic synchronization.

In the automatic synchronization process, the algorithm searches the best correlation of DPCCH pilot pattern among slot format 0, 1, 2 and 3. (The reason the algorithm doesn't search slot format 4 and 5 is that 3GPP standard release 6 no longer defines slot format 4 and 5.)

If signal in slot format 4 is given, the auto-sync algorithm considers it as slot format 0.

If signal in slot format 5 is given, the auto-sync algorithm considers it as slot format 2.

Manual setting of the slot format (SF0 to SF5) is also supported as previous.

- SF0 – Slot Format 0
- SF1 – Slot Format 1
- SF2 – Slot Format 2
- SF3 – Slot Format 3
- SF4 – Slot Format 4
- SF5 – Slot Format 5

Programming Commands
Modulation Accuracy (Rho) Measurement

Slot Format #i	Channel Bit Rate (kbps)	Channel Symbol Rate (ksps)	SF	Bits/Frame	Bits/Slot	Npilot	NTPC	NTFCI	NFBI	Transmitted slots per radio frame
0	15	15	256	150	10	6	2	2	0	15
0A	15	15	256	150	10	5	2	3	0	10–14
0B	15	15	256	150	10	4	2	4	0	8–9
1	15	15	256	150	10	8	2	0	0	8–15
2	15	15	256	150	10	5	2	2	1	15
2A	15	15	256	150	10	4	2	3	1	10–14
2B	15	15	256	150	10	3	2	4	1	8–9
3	15	15	256	150	10	7	2	0	1	8–15
4	15	15	256	150	10	6	2	0	2	8–15
5	15	15	256	150	10	5	1	2	2	15
5A	15	15	256	150	10	4	1	3	2	10–14
5B	15	15	256	150	10	3	1	4	2	8–9

NOTE 0A, 0B, 2A, 2B, 5A and 5B are slot formats for uplink DPCCH compressed frame. They are unavailable as the uplink slot format parameter.

Example :SENSe:RHO:SFORmat:MS SF1

Notes This command is effective when [:SENSe]:RADio:DEVice is set to MS, and [:SENSe]:RHO:SYNC:MS is set to DPCCh.

Preset SF0

State Saved Saved in instrument state.

Range SF0 | SF1 | SF2 | SF3 | SF4 | SF5 | Auto

Key Path **Meas Setup, More**

Modulation Accuracy (Rho)—Sync Start Slot Number Detection State

`[:SENSe] :RHO:SSLot:NUMBER <integer>`

`[:SENSe] :RHO:SSLot:NUMBER?`

`[:SENSe] :RHO:SSLot [:STATe] OFF | ON | 0 | 1`

`[:SENSe] :RHO:SSLot [:STATe] ?`

Allows you to specify a slot as the first slot to measure.

If Sync Start Slot state is set to Off, the measurement performs synchronization at any slot found right after the trigger timing.

Example	<code>:SENSe:RHO:SSLot:NUMBER 5</code> <code>:SENSe:RHO:SSLot:STATe ON</code>
Notes	The softkey is grayed out if device is MS and Sync Type is PRACH Message.
Remote Command Notes	Turn first slot number detection mode on or off.
Preset	0, OFF
State Saved	Saved in instrument state.
Range	0 to 14
Key Path	Meas Setup, More
Active Function Text	Sync Start Slot

Modulation Accuracy (Rho)—Spectrum Normal/Invert

`[:SENSe] :RHO:SPECTrum INVert | NORMal`

`[:SENSe] :RHO:SPECTrum?`

Set a spectrum either to normal or inverted for the demodulation related measurements. If set to INVert, the upper and lower spectrums are swapped.

Invert : This function conjugates the spectrum, which is equivalent to taking the negative of the quadrature component in demodulation. The correct setting (Normal or Invert) depends on whether the signal at the input of the instrument has a high or low side mix.

Preset	NORMal
State Saved	Saved in instrument state.
Range	Normal Invert
Key Path	Meas Setup, More, More
Remarks	You must be in the cdmaOne, cdma2000, W-CDMA, or 1xEV-DO mode to use this command. Use INSTRument:SElect to set the mode.

Modulation Accuracy (Rho)—Transient Period Exclude

```
[ :SENSe] :RHO:SWEEp:TIME:TRANSient INCLude | EXCLude
```

```
[ :SENSe] :RHO:SWEEp:TIME:TRANSient?
```

Select either to include the transient period or to exclude. The transient period is specified in the 3GPP standard TS 34.121, and 25us before each slot boundary and 25 us after each slot boundary. In the 3GPP standard, it is required that the transient period is not included for the power measurement.

Example	:SENSe:RHO:SWEEp:TIME:TRANSient EXCLude
Preset	INCLude
State Saved	Saved in instrument state.
Range	Inc Exc
Key Path	Meas Setup, More

Modulation Accuracy (RHO)—Sync Type (BTS)

```
[ :SENSe] :RHO:SYNC [ :BTS]
```

```
CPICH | SCH | SYMBol | STTD | A2CPich | A1Sch | A2SCh
```

```
[ :SENSe] :RHO:SYNC [ :BTS] ?
```

CPICH - Synchronize with the common pilot channel (CPICH).

SCH - Synchronize with the synchronization channel (SCH).

Symbol Based - Allows you to access the menu for the code symbol to synchronize with.

- Symbol Rate - Allows you to set the symbol rate ranging from 7.5 to 960 ksps. The parameter automatically sets the maximum value for Code Number when appropriate.
- Code Number - Allows you to set the code number. The range is 0 to 511 depending on the Symbol Rate setting.
- Antenna-2 CPICH - Allows you to synchronize with the STTD Antenna-2 common pilot channel.
- STTD Diff - Allows you to synchronize to the common pilot channel channel at STTD antenna-1 and antenna-2 to make Diversity Time Error measurements.

- TSTD SCH Antenna1 – Allows you synchronize the antenna1 of TSTD SCH.
- TSTD SCH Antenna2 – Allows you synchronize the antenna2 of TSTD SCH.

Dependencies and Couplings	SYMBOL:synchronize to the code symbol specified by [:SENSE]:RHO:SYNC:SYMBOL:SRATE and the [:SENSE]:RHO:SYNC:SYMBOL:SPREAD commands.
Remote Command Notes	This command is effective when [:SENSE]:RADIO:DEVICE is set to BTS.
Preset	CPICH
State Saved	Saved in instrument state.
Range	CPICH SCH Symbol Based STTD Diff Antenna-2 CPICH Antenna-1 TSTD SCH Antenna-2 TSTD SCH
Key Path	Meas Setup, More

Modulation Accuracy (Rho)—Sync Type (MS)

[:SENSE]:RHO:SYNC:MS DPCCh | PMESage

[:SENSE]:RHO:SYNC:MS?

Select DPCCh or PMESage for synchronization to uplink signal.

DPCCh - Synchronize to DPCCH and Slot Format which is specified by [:SENSE]:RHO:SFORMAT:MS

PMESage - Synchronize to PRACH Message and Slot Format which is specified by [:SENSE]:RHO:SFORMAT:MS

Remote Command Notes	This command is effective when [:SENSE]:RADIO:DEVICE is set to MS.
Preset	DPCCh
State Saved	Saved in instrument state.
Range	DPCCH PRACH Message
Key Path	Meas Setup, More

Remarks: You must be in the W-CDMA mode to use this command. Use INSTRUMENT:SELECT to set the mode.

Modulation Accuracy (Rho)—Scramble Code Down Link

`[[:SENSe]:RHO:SYNC:SCRamble[:BTS] <integer>`

`[[:SENSe]:RHO:SYNC:SCRamble[:BTS] ?`

Set the BTS primary scramble code for synchronization. The BTS scramble code number (Down Link) is determined by “Primary Scramble Code”, “Scramble Code Offset” and “Scramble Code Type”.

Notes	This command is effective when [:SENSe]:RADio:DEVIce is set to BTS.
Preset	0
State Saved	Saved in instrument state.
SCPI Resolution	1
Key Path	Meas Setup, More
Range:	0 to 511
Remarks:	You must be in the W-CDMA mode to use this command. Use INSTRument:SElect to set the mode.

Modulation Accuracy (Rho)—Scramble Code Offset [BTS only]

`[[:SENSe]:RHO:SYNC:SCRamble[:BTS]:OFFSet <integer>`

`[[:SENSe]:RHO:SYNC:SCRamble[:BTS]:OFFSet ?`

Allows you to set the number of scramble code offsets to make the modulation accuracy measurement. This key is not available if Device is set to MS.

Notes	This command is effective when [:SENSe]:RADio:DEVIce is set to BTS. (0 for the primary scramble code; 1 to 15 for the secondary scramble code)
Preset	0
State Saved	Saved in instrument state.
SCPI Resolution	1
Key Path	Meas Setup, More

Modulation Accuracy (Rho)—Scramble Code Type [BTS only]

```
[ :SENSe ] :RHO:SYNC:SCRamble [ :BTS ] :TYPE LEFT | RIGHT |  
STANdard
```

```
[ :SENSe ] :RHO:SYNC:SCRamble [ :BTS ] :TYPE?
```

Set the BTS primary scramble code type for synchronization.

Allows you to set the scramble code type to either Std (standard), Left, or Right to make the modulation accuracy measurement. This key is not available if Device is set to MS.

- **LEFT** – the left alternative scrambling code whose number is the primary scramble code number + 8192 is used.
- **RIGHT** – the right alternative scrambling code whose number is the primary scrambling code number + 16384 is used.
- **STANdard** – the standard scrambling code whose number is the primary scrambling code number is used.

Notes	This command is effective when [:SENSe] :RADio:DEVice is set to BTS.
Preset	STANdard
State Saved	Saved in instrument state.
Range	Std Left Right
Key Path	Meas Setup, More

Modulation Accuracy (Rho)—Scramble Code Up Link [MS Only]

`[[:SENSe]:RHO:SYNC:SCRamble:MS <integer>`

`[[:SENSe]:RHO:SYNC:SCRamble:MS?`

Set the MS scramble code for synchronization. When this key is selected, “Hex Input” menu appears.

Notes	This command is effective when [:SENSe]:RADio:DEVICE is set to MS. Range: 0 to 16,777,215 (0x0 to 0xFFFFFFFF; 24 bits)
Preset	0x0
State Saved	Saved in instrument state.
SCPI Resolution	1
Key Path	Meas Setup, More
Range:	0 to 16,777,215 (0h to FFF,FFFh)
Remarks:	You must be in the W-CDMA mode to use this command. Use INSTRument:SElect to set the mode.

Modulation Accuracy (Rho)—Synchronization Symbol Spread Code

`[[:SENSE]:RHO:SYNC:SYMBOL:SPRead <integer>`

`[[:SENSE]:RHO:SYNC:SYMBOL:SPRead?`

Set the spread code of the code symbol to synchronize with. This command is effective when the `[[:SENSE]:RHO:SYNC` command is set to `SYMBOL`.

Notes	<p>This command is effective when <code>[[:SENSE]:RADio:DEvice</code> is set to <code>BTS</code>, and <code>[[:SENSE]:RHO:SYNC[:BTS]</code> is set to <code>SYMBOL</code>.</p> <p>Min:0</p> <p>Max value changes as follows:</p> <p>511, when <code>[[:SENSE]:RHO:SYNC:SYMBOL:SRATe=7500</code></p> <p>255, when <code>[[:SENSE]:RHO:SYNC:SYMBOL:SRATe=15000</code></p> <p>127, when <code>[[:SENSE]:RHO:SYNC:SYMBOL:SRATe=30000</code></p> <p>63, when <code>[[:SENSE]:RHO:SYNC:SYMBOL:SRATe=60000</code></p> <p>31, when <code>[[:SENSE]:RHO:SYNC:SYMBOL:SRATe=120000</code></p> <p>15, when <code>[[:SENSE]:RHO:SYNC:SYMBOL:SRATe=240000</code></p> <p>7, when <code>[[:SENSE]:RHO:SYNC:SYMBOL:SRATe=480000</code></p> <p>3, when <code>[[:SENSE]:RHO:SYNC:SYMBOL:SRATe=960000</code></p> <p>SCPI Resolution:1</p>
Dependencies and Couplings	See Restriction and Notes
Preset	1
State Saved	Saved in instrument state.
SCPI Resolution	1
Key Path	Meas Setup, More, Sync Type, Symbol Based
Remarks:	You must be in the W-CDMA mode to use this command. Use <code>INSTRument:SElect</code> to set the mode.

Modulation Accuracy (Rho)—Synchronization Symbol Spread Rate

`[[:SENSe]:RHO:SYNC:SYMBOL:SRATE <integer>`

`[[:SENSe]:RHO:SYNC:SYMBOL:SRATE?`

Set the symbol rate of the code symbol to synchronize with. This command is effective when the `[[:SENSe]:RHO:SYNC]` command is set to `SYMBOL`.

Notes	This command is effective when <code>[[:SENSe]:RADio:DEVIce]</code> is set to <code>BTS</code> , and <code>[[:SENSe]:RHO:SYNC[:BTS]]</code> is set to <code>SYMBOL</code> .
Preset	7500
State Saved	Saved in instrument state.
Range	7500 15000 30000 60000 120000 240000 480000 960000
Key Path	Meas Setup, More, Sync Type, Symbol Based
Front-panel Unit/Terminator Keys	sps ksp

Remarks: You must be in the W-CDMA mode to use this command. Use `INSTrument:SElect` to set the mode.

Modulation Accuracy (Rho)—Trigger Source

```
[ :SENSE ] :RHO:TRIGger:SOURce IMMEDIATE | IF
| EXTERNAL [1] | EXTERNAL2 | RFBURSt | FRAME
```

```
[ :SENSE ] :RHO:TRIGger:SOURce?
```

Select the trigger source used to control the data acquisitions.

Immediate - The trigger occurs at the time the data is requested, completely asynchronous to the RF or IF signal (also called free run).

Free Run (Immediate) - The trigger occurs at the time the data is requested, completely asynchronous to the RF or IF signal (also called free run).

EXTERNAL 1 – Activates the external 1 trigger input. Location of the BNC Connector is the Front panel.

The external trigger must be a signal between 5 and +5 volts

EXTERNAL 2 – Activates the external 2 trigger input. . Location of the BNC Connector is the Front panel.

The external trigger must be a signal between 5 and +5 volts.

FRAME – Uses the internal periodic timer (used to called ‘frame clock’) to generate a trigger signal

IF – An internal IF envelope trigger. It triggers on an absolute threshold level of the signal passed by the IF.

IMMEDIATE – the next data acquisition is immediately taken, capturing the signal asynchronously (also called free run).

RFBURSt – An internal wideband RF burst trigger that has an automatic level control for burst signals. It triggers on a level that is relative to the peak of the signal passed by the RF or absolute level

Preset	IMMEDIATE
State Saved	Saved in instrument state.
Range	Free Run (Immediate) Video (IF Envlp) RF Burst Ext Front Ext Rear Frame
Key Path	Meas Setup, More, More
Remarks:	You must be in the cdmaOne, cdma2000, W-CDMA, or 1xEV-DO mode to use this command. Use INSTRUMENT:SELEct to set the mode.
Key Path:	Meas Setup, Trig Source

Reference Oscillator Commands

Reference Oscillator External Frequency

`[:SENSe] :ROSCillator:EXTernal:FREQuency <frequency>`

`[:SENSe] :ROSCillator:EXTernal:FREQuency?`

Specify to the frequency of the external reference being supplied to the instrument. Switch to the external reference with `ROSC:SOUR`.

Preset

and `*RST`: Value remains at last user selected value (persistent)

Factory default, 10 MHz

Range: 1 MHz to 30 MHz, with 1 Hz steps

Default Unit: Hz

Remarks: Global to system

Key Path: **System, Reference, Ref Oscillator**

Reference Oscillator Rear-Panel Output

```
[[:SENSE]:ROSCillator:OUTPut[:STATe] OFF|ON|0|1
```

```
[[:SENSE]:ROSCillator:OUTPut?
```

Turn on and off the 10 MHz frequency reference signal going to the rear panel.

Preset
and *RST: Persistent State with factory default of On

Remarks: Global to system. Was SENS:ROSC:REAR

Key Path: **System, Reference, 10 MHz Out**

Reference Oscillator Source

```
[[:SENSE]:ROSCillator:SOURce INTernal|EXTernal
```

```
[[:SENSE]:ROSCillator:SOURce?
```

Select the reference oscillator (time base) source. Use ROSC:EXT:FREQ to tell the instrument the frequency of the external reference.

INTernal - uses internally generated 10 MHz reference signal

EXTernal - uses the signal at the rear-panel external reference input port.

Preset
and *RST: Persistent State with factory default of Internal

Remarks: Global to system.

Key Path: **System, Reference, Ref Oscillator**

Spectrum Emission Mask Measurement (Spurious Emissions)

Commands for querying the Spectrum Emission Mask measurement results and for setting to the default values are found in the “[MEASure Group of Commands](#)” on page 519. The equivalent front-panel keys for the parameters described in the following commands, are found under the **Meas Setup** key, after selecting the measurement from the **MEASURE** key menu. Select the **Spectrum Emission Mask** measurement (for W-CDMA, cdma2000) or the **Spurious Emissions and ACP** measurement (for 1xEV-DO).

History: E4406A:
Added version A.04.00 and later

Spectrum Emission Mask—Average Count

`[:SENSe] :SEMAsk:AVERAge:COUNT <integer>`

`[:SENSe] :SEMAsk:AVERAge:COUNT?`

Set the number of data acquisitions that will be averaged. After the specified number of average count, the average mode (termination control) setting determines the average action.

Factory Preset: 10

Range: 1 to 10,000

Remarks: You must be in the cdma2000, W-CDMA, or 1xEV-DO mode to use this command. Use `INSTRument:SElect` to set the mode.

Spectrum Emission Mask—Averaging State

`[:SENSe] :SEMAsk:AVERAge [:STATe] OFF | ON | 0 | 1`

`[:SENSe] :SEMAsk:AVERAge [:STATe] ?`

Turn the averaging function On or Off.

Factory Preset: OFF

Remarks: You must be in the cdma2000, W-CDMA, or 1xEV-DO mode to use this command. Use `INSTRument:SElect` to set the mode.

Spectrum Emission Mask—Reference Channel Integration Bandwidth

cdma2000, W-CDMA mode

```
[ :SENSE ] :SEMask :BANDwidth [ n ] | BWIDth [ n ] :INTEgration <freq>
```

```
[ :SENSe ] :SEMask :BANDwidth [ n ] | BWIDth [ n ] :INTEgration ?
```

1xEV-DO mode

```
[ :SENSE ] :SEMask :BANDwidth | BWIDth :INTEgration [ m ] <freq>
```

```
[ :SENSe ] :SEMask :BANDwidth | BWIDth :INTEgration [ m ] ?
```

Set the integration bandwidth that will be used for the reference channel.

BANDwidth[n] | BWIDth[n]

n=1 is the base station test and n=2 is the mobile station test. The default is the base station test (1). (cdma2000, W-CDMA mode only)

INTEgration[m] m=1 is the spectrum emission mask (SEM) mode and m=2 is the adjacent channel power (ACP) mode. The default is the SEM mode (1). (1xEV-DO mode only)

Factory Preset: 1.23 MHz for cdma2000, 1xEV-DO
3.84 MHz for W-CDMA

Range: 100.0 kHz to 1.250 MHz

Default Unit: Hz

Remarks: You must be in the cdma2000, W-CDMA, or 1xEV-DO mode to use this command. Use INSTRument:SElect to set the mode.

Spectrum Emission Mask—Reference Channel Resolution Bandwidth

cdma2000, W-CDMA mode

```
[[:SENSE]:SEMAsk:BANDwidth[n] | BWIDth[n]:RESolution <freq>
```

```
[[:SENSE]:SEMAsk:BANDwidth[n] | BWIDth[n]:RESolution?
```

1xEV-DO mode

```
[[:SENSE]:SEMAsk:BANDwidth | BWIDth:RESolution[m] <freq>
```

```
[[:SENSE]:SEMAsk:BANDwidth | BWIDth:RESolution[m] ?
```

Set the resolution bandwidth for the reference channel.

BANDwidth[n] | BWIDth[n]

n=1 is the base station test and n=2 is the mobile station test. The default is the base station test (1). (cdma2000, W-CDMA mode only)

RESolution[m] m=1 is the spectrum emission mask (SEM) mode and m=2 is the adjacent channel power (ACP) mode. The default is the SEM mode (1). (1xEV-DO mode only)

Factory Preset: No valid value as the default is set to Auto. See [[:SENS]:SEM:BAND[n] | BWID[n]:RES[m]:AUTO.

Range: 1.0 kHz to 7.5 MHz

Default Unit: Hz

Remarks: You must be in the cdma2000, W-CDMA, or 1xEV-DO mode to use this command. Use INSTRument:SElect to set the mode.

Spectrum Emission Mask—Auto Mode for Reference Channel Resolution Bandwidth

cdma2000, W-CDMA mode

```
[ :SENSE ] :SEMask :BANDwidth [n] | BWIDth [n] :RESolution :AUTO  
OFF | ON | 0 | 1
```

```
[ :SENSE ] :SEMask :BANDwidth [n] | BWIDth [n] :RESolution :AUTO?
```

1xEV-DO mode

```
[ :SENSE ] :SEMask :BANDwidth | BWIDth :RESolution [m] :AUTO  
OFF | ON | 0 | 1
```

```
[ :SENSE ] :SEMask :BANDwidth | BWIDth :RESolution [m] :AUTO?
```

Set the auto mode to determine the resolution bandwidth to On or Off. If set to Off, enter a frequency value referring to [:SENS]:SEM:BAND[n]|BWID[n]:RES[m].

BANDwidth[n]|BWIDth[n]

n=1 is the base station test and n=2 is the mobile station test. The default is the base station test (1). (cdma2000, W-CDMA mode only)

RESolution[m] m=1 is the spectrum emission mask (SEM) mode and m=2 is the adjacent channel power (ACP) mode. The default is the SEM mode (1). (1xEV-DO mode only)

Factory Preset: ON

Remarks: You must be in the cdma2000, W-CDMA, or 1xEV-DO mode to use this command. Use INSTRUMENT:SELECT to set the mode.

Spectrum Emission Mask—Detector Mode

```
[ :SENSe] :SEMask:DETEctor [:FUNction] AAVerage|POSitive
```

```
[ :SENSe] :SEMask:DETEctor [:FUNction] ?
```

Select one of the detector modes for spectrum measurements.

AAVerage (absolute average) - the absolute average power in each frequency is measured across the spectrum

POSitive - the positive peak power in each frequency is measured across the spectrum

Factory Preset: AAVerage (absolute average)

Remarks: You must be in the cdma2000, W-CDMA, or 1xEV-DO mode to use this command. Use INSTRument:SElect to set the mode.

Spectrum Emission Mask—Root Raised Cosine Filter Alpha

```
[ :SENSe] :SEMask:FILTer [:RRC] :ALPHa <numeric>
```

```
[ :SENSe] :SEMask:FILTer [:RRC] :ALPHa ?
```

Sets the alpha value (roll-off factor) of Root Raised Cosine (RRC) filter.

Factory Preset
and *RST 0.22

Range: 0.01 to 0.5

Remarks: You must be in the W-CDMA to use this command. Use INSTRument:SElect to set the mode.

Key Path: Meas Setup, Ref Channel, Filter Alpha

State Saved: Saved in Instrument State

Spectrum Emission Mask—Root Raised Cosine Filter Control

```
[ :SENSE ] :SEMAsk:FILTer [:RRC] [:STATe] OFF|ON|0|1
```

```
[ :SENSE ] :SEMAsk:FILTer [:RRC] [:STATe] ?
```

Turns the Root Raised Cosine (RRC) filter on or off.

Factory Preset
and *RST OFF

Remarks: You must be in the W-CDMA to use this command. Use INSTRument:SElect to set the mode.

Key Path: Meas Setup -> Ref Channel -> RRC Filter

State Saved: Saved in Instrument State

Spectrum Emission Mask—Channel Frequency Span

```
[ :SENSe ] :SEMAsk:FREQuency [n] :SPAN [m] <freq>
```

```
[ :SENSe ] :SEMAsk:FREQuency [n] :SPAN [m] ?
```

Enter a frequency value to set the channel frequency span for the reference channel integration.

FREQuency[n] n=1 is the base station test and n=2 is the mobile test. The default is the base station test (1). (cdma2000, W-CDMA mode only)

SPAN[m] m=1 is the spectrum emission mask (SEM) mode and m=2 is the adjacent channel power (ACP) mode. The default is the SEM mode (1). (1xEV-DO mode only)

Factory Preset: 1.25 MHz for cdma2000, 1xEV-DO

5.0 MHz for W-CDMA

Range: 100.0 kHz to 10.0 MHz

Remarks: You must be in the cdma2000, W-CDMA, or 1xEV-DO mode to use this command. Use INSTRument:SElect to set the mode.

Spectrum Emission Mask—Reference Channel Step Frequency

cdma2000, W-CDMA mode

```
[ :SENSe ] :SEMask:FREQuency [n] :STEP <freq>
```

```
[ :SENSe ] :SEMask:FREQuency [n] :STEP?
```

1xEV-DO mode

```
[ :SENSe ] :SEMask:FREQuency:STEP [m] <freq>
```

```
[ :SENSe ] :SEMask:FREQuency:STEP [m] ?
```

Enter a frequency value to set the step frequency for the reference channel integration.

FREQuency[n] n=1 is the base station test and n=2 is the mobile test. The default is the base station test (1). (cdma2000, W-CDMA mode only)

STEP[m] m=1 is the spectrum emission mask (SEM) mode and m=2 is the adjacent channel power (ACP) mode. The default is the SEM mode (1). (1xEV-DO mode only)

Factory Preset: No valid value as the default is set to Auto. See [:SENS]:SEM:FREQ[n]:STEP[m]:AUTO.

Range: 100 Hz to 7.5 MHz

Remarks: You must be in the cdma2000, W-CDMA, or 1xEV-DO mode to use this command. Use INSTRument:SElect to set the mode.

Spectrum Emission Mask—Auto Mode for Reference Channel Step Frequency

cdma2000, W-CDMA mode

```
[[:SENSE]:SEMAsk:FREQuency[n]:STEP:AUTO OFF|ON|0|1
```

```
[[:SENSe]:SEMAsk:FREQuency[n]:STEP:AUTO?
```

1xEV-DO mode

```
[[:SENSE]:SEMAsk:FREQuency:STEP[m]:AUTO OFF|ON|0|1
```

```
[[:SENSe]:SEMAsk:FREQuency:STEP[m]:AUTO?
```

Set the auto mode to determine the step frequency to On or Off.

OFF - enter a value to set the step frequency for the reference channel integration, referring to [:SENSe]:SEM:FREQ[n]:STEP[m].

ON - the step frequency for the reference channel integration is set to a half of the resolution bandwidth.

FREQuency[n] n=1 is the base station test and n=2 is the mobile test. The default is the base station test (1). (cdma2000, W-CDMA mode only)

STEP[m] m=1 is the spectrum emission mask (SEM) mode and m=2 is the adjacent channel power (ACP) mode. The default is the SEM mode (1). (1xEV-DO mode only)

Factory Preset: ON

Remarks: You must be in the cdma2000, W-CDMA, or 1xEV-DO mode to use this command. Use INSTRument:SElect to set the mode.

Spectrum Emission Mask—Offset Resolution Bandwidth

cdma2000, W-CDMA mode

```
[[:SENSe]:SEMAsk:OFFSet [n]:LIST:BAWdwidth|BWIDTh
<res_bw>,<res_bw>,<res_bw>,<res_bw>,<res_bw>
```

```
[[:SENSe]:SEMAsk:OFFSet [n]:LIST:BAWdwidth|BWIDTh?
```

1xEV-DO mode

```
[[:SENSe]:SEMAsk:OFFSet:LIST [m]:BAWdwidth|BWIDTh
<res_bw>,<res_bw>,<res_bw>,<res_bw>,<res_bw>
```

```
[[:SENSe]:SEMAsk:OFFSet:LIST [m]:BAWdwidth|BWIDTh?
```

Define the offset resolution bandwidth for Spectrum Emission Mask measurements. The list must contain five (5) entries. You can turn off (not use) specific offsets with [:SENS]:SEM:OFFS[n]:LIST[m]:STAT.

OFFSet[n] n=1 is the base station test and n=2 is the mobile test. The default is the base station test (1). (cdma2000, W-CDMA only)

LIST[m] m=1 is the spectrum emission mask (SEM) mode and m=2 is the adjacent channel power (ACP) mode. The default is the SEM mode (1). (1xEV-DO mode only)

Factory Preset:

Mode	Variant	Offset A	Offset B	Offset C	Offset D	Offset E
cdma2000	BTS	3.00 kHz	30.00 kHz	30.0 kHz	6.25 kHz	1.000 MHz
	MS	30.00 kHz	30.00 kHz	6.25 kHz	1.000 MHz	1.000 MHz
W-CDMA	BTS	30.00 kHz	30.00 kHz	30.00 kHz	50.00 kHz	1.000 MHz
	MS	30.00 kHz	1.000 MHz	1.000 MHz	1.000 MHz	1.000 MHz
1xEV-DO	SEM	3.000 kHz	30.00 kHz	30.00 kHz	6.250 kHz	1.000 MHz
	ACP	3.000 kHz	30.00 kHz	30.00 kHz	30.00 kHz	30.00 kHz

Range: 300 Hz to 7.5 MHz

Default Unit: Hz

Remarks: You must be in the cdma2000, W-CDMA, or 1xEV-DO mode to use this command. Use INSTRument:SElect to set the mode.

Spectrum Emission Mask—Auto Offset Resolution Bandwidth

cdma2000, W-CDMA mode

```
[ :SENSE ] :SEMask:OFFSet [n] :LIST:BANDwidth | BWIDth:AUTO  
OFF | ON | 0 | 1, OFF | ON | 0 | 1, OFF | ON | 0 | 1, OFF | ON | 0 | 1, OFF | ON | 0 | 1
```

```
[ :SENSE ] :SEMask:OFFSet [n] :LIST:BANDwidth | BWIDth:AUTO?
```

1xEV-DO mode

```
[ :SENSE ] :SEMask:OFFSet:LIST [m] :BANDwidth | BWIDth:AUTO  
OFF | ON | 0 | 1, OFF | ON | 0 | 1, OFF | ON | 0 | 1, OFF | ON | 0 | 1, OFF | ON | 0 | 1
```

```
[ :SENSE ] :SEMask:OFFSet:LIST [m] :BANDwidth | BWIDth:AUTO?
```

Set the auto mode to determine the offset resolution bandwidth to On or Off.

OFF - enter a value to set the resolution bandwidth for an offset channel, referring to [:SENSE]:SEMask:OFFSet[n]:LIST[m]BAND | BWID.

ON - the resolution bandwidth for an offset channel is automatically set according to the offset start and stop frequencies.

OFFSet[n] n=1 is the base station test and n=2 is the mobile test. The default is the base station test (1). (cdma2000, W-CDMA mode only)

LIST[m] m=1 is the spectrum emission mask (SEM) mode and m=2 is the adjacent channel power (ACP) mode. The default is the SEM mode (1). (1xEV-DO mode only)

Factory Preset and *RST:

Mode	Variant	Offset A	Offset B	Offset C	Offset D	Offset E
cdma2000		OFF	OFF	OFF	OFF	OFF
W-CDMA		OFF	OFF	OFF	OFF	OFF
1xEV-DO	SEM	OFF	OFF	OFF	OFF	OFF
	ACP	OFF	OFF	OFF	OFF	OFF

Remarks: You must be in the cdma2000, W-CDMA, or 1xEV-DO mode to use this command. Use INSTRument:SElect to set the mode.

Spectrum Emission Mask—Offset Resolution Bandwidth Multiplier

cdma2000, W-CDMA mode

```
[ :SENSE ] :SEMask:OFFSet [n] :LIST:BANDwidth | BWIDth:IMULti
<integer>, <integer>, <integer>, <integer>, <integer>
```

```
[ :SENSE ] :SEMask:OFFSet [n] :LIST:BANDwidth | BWIDth:IMULti?
```

1xEV-DO mode

```
[ :SENSE ] :SEMask:OFFSet:LIST [m] :BANDwidth | BWIDth:IMULti
<integer>, <integer>, <integer>, <integer>, <integer>
```

```
[ :SENSE ] :SEMask:OFFSet:LIST [m] :BANDwidth | BWIDth:IMULti?
```

Specify a multiplier of the offset resolution bandwidth for the offset measurement integration bandwidth.

OFFSet[n] n=1 is the base station test and n=2 is the mobile test. The default is the base station test (1). (cdma2000, W-CDMA mode only)

LIST[m] m=1 is the spectrum emission mask (SEM) mode and m=2 is the adjacent channel power (ACP) mode. The default is the SEM mode (1). (1xEV-DO mode only)

Factory Preset:

Mode	Variant	Offset A	Offset B	Offset C	Offset D	Offset E
cdma2000	BTS	10	1	1	1	1
	MS	1	1	1	1	1
W-CDMA	BTS	1	1	1	20	1
	MS	1	1	1	1	1
1xEV-DO	SEM	10	1	1	1	1
	ACP	10	1	1	1	1

Range: 1 to ((Stop frequency – Start frequency) / Resolution bandwidth)

Remarks: You must be in the cdma2000, W-CDMA, or 1xEV-DO mode to use this command. Use INSTRument:SElect to set the mode.

Spectrum Emission Mask—Offset Start Frequency

cdma2000, W-CDMA mode

```
[ :SENSE ] :SEMask:OFFSet [n] :LIST:FREQuency:STARt
<f_offset>,<f_offset>,<f_offset>,<f_offset>,<f_offset>
```

```
[ :SENSE ] :SEMask:OFFSet [n] :LIST:FREQuency:STARt?
```

1xEV-DO mode

```
[ :SENSE ] :SEMask:OFFSet:LIST [m] :FREQuency:STARt
<f_offset>,<f_offset>,<f_offset>,<f_offset>,<f_offset>
```

```
[ :SENSE ] :SEMask:OFFSet:LIST [m] :FREQuency:STARt?
```

Set the five (5) sets of the offset start frequencies.

OFFSet[n] n=1 is the base station test and n=2 is the mobile test. The default is the base station test (1). (cdma2000, W-CDMA mode only)

LIST[m] m=1 is the spectrum emission mask (SEM) mode and m=2 is the adjacent channel power (ACP) mode. The default is the SEM mode (1). (1xEV-DO mode only)

Factory Preset:

Mode	Variant	Offset A	Offset B	Offset C	Offset D	Offset E
cdma2000	BTS	765.0 kHz	795.0 kHz	1.195 MHz	3.2531 MHz	7.500 MHz
	MS	900.0 kHz	1.995 MHz	2.2531 MHz	8.500 MHz	12.50 MHz
W-CDMA	BTS	2.515 MHz	2.715 MHz	3.515 MHz	4.000 MHz	8.000 MHz
	MS	2.515 MHz	4.000 MHz	7.500 MHz	8.500MHz	12.50 MHz
1xEV-DO	SEM	765.0 kHz	795.0 kHz	1.995 MHz	3.2531 MHz	7.500 MHz
	ACP	765.0 kHz	1.995 MHz	3.125 MHz	4.000 MHz	7.500 MHz

Range: 10.0 kHz to 100.0 MHz

Default Unit: Hz

Remarks: You must be in the cdma2000, W-CDMA, or 1xEV-DO mode to use this command. Use INSTRument:SElect to set the mode.

Spectrum Emission Mask—Offset Step Frequency

cdma2000, W-CDMA mode

```
[ :SENSE ] :SEMAsk:OFFSet [n] :LIST:FREQuency:STEP  
<f_offset>,<f_offset>,<f_offset>,<f_offset>,<f_offset>
```

```
[ :SENSe ] :SEMAsk:OFFSet [n] :LIST:FREQuency:STEP?
```

1xEV-DO mode

```
[ :SENSE ] :SEMAsk:OFFSet:LIST [m] :FREQuency:STEP  
<f_offset>,<f_offset>,<f_offset>,<f_offset>,<f_offset>
```

```
[ :SENSe ] :SEMAsk:OFFSet:LIST [m] :FREQuency:STEP?
```

Set the five (5) sets of the offset step frequencies.

OFFSet[n] n=1 is the base station test and n=2 is the mobile test.
The default is the base station test (1). (cdma2000,
W-CDMA mode only)

LIST[m] m=1 is the spectrum emission mask (SEM) mode and
m=2 is the adjacent channel power (ACP) mode. The
default is the SEM mode (1). (1xEV-DO mode only)

Factory Preset: No valid value as the default is set to Auto. See
[:SENS]:SEM:OFF[n]:LIST[m]:FREQ:STEP:AUTO.

Range: 100 Hz to 7.5 MHz

The minimum value is determined to be equal to or
greater than one 2000th (1/2000) of the frequency
difference derived from (Stop Freq – Start Freq).

Default Unit: Hz

Remarks: You must be in the cdma2000, W-CDMA, or 1xEV-DO
mode to use this command. Use INSTRument:SElect to
set the mode.

Spectrum Emission Mask—Auto Offset Step Frequency

cdma2000, W-CDMA mode

```
[ :SENSE ] :SEMask :OFFSet [n] :LIST:FREQuency:STEP:AUTO  
OFF | ON | 0 | 1, OFF | ON | 0 | 1, OFF | ON | 0 | 1, OFF | ON | 0 | 1, OFF | ON | 0 | 1
```

```
[ :SENSE ] :SEMask :OFFSet [n] :LIST:FREQuency:STEP:AUTO?
```

1xEV-DO mode

```
[ :SENSE ] :SEMask :OFFSet :LIST [m] :FREQuency:STEP:AUTO  
OFF | ON | 0 | 1, OFF | ON | 0 | 1, OFF | ON | 0 | 1, OFF | ON | 0 | 1, OFF | ON | 0 | 1
```

```
[ :SENSE ] :SEMask :OFFSet :LIST [m] :FREQuency:STEP:AUTO?
```

Set the auto mode to determine the offset step frequency to On or Off.

OFF - enter a value to set the step frequency for an offset channel, referring to [:SENSE]:SEMask:OFFSet[n]:LIST[m]:FREQuency:STEP.

ON - the step frequency for an offset channel is automatically set according to the offset start and stop frequencies.

OFFSet[n] n=1 is the base station test and n=2 is the mobile test. The default is the base station test (1). (cdma2000, W-CDMA mode only)

LIST[m] m=1 is the spectrum emission mask (SEM) mode and m=2 is the adjacent channel power (ACP) mode. The default is the SEM mode (1). (1xEV-DO mode only)

Factory Preset:

Mode	Variant	Offset A	Offset B	Offset C	Offset D	Offset E
cdma2000		ON	ON	ON	ON	ON
W-CDMA		ON	ON	ON	ON	ON
1xEV-DO	SEM	ON	ON	ON	ON	ON
	ACP	ON	ON	ON	ON	ON

Remarks: You must be in cdma2000, W-CDMA, or 1xEV-DO mode to use this command. Use INSTRUMENT:SElect to set the mode.

Spectrum Emission Mask—Offset Stop Frequency

cdma2000, W-CDMA mode

```
[ :SENSE] :SEMask:OFFSet [n] :LIST:FREQuency:STOP
<f_offset>,<f_offset>,<f_offset>,<f_offset>,<f_offset>
```

```
[ :SENSe] :SEMask:OFFSet [n] :LIST:FREQuency:STOP?
```

1xEV-DO mode

```
[ :SENSE] :SEMask:OFFSet:LIST [m] :FREQuency:STOP
<f_offset>,<f_offset>,<f_offset>,<f_offset>,<f_offset>
```

```
[ :SENSe] :SEMask:OFFSet:LIST [m] :FREQuency:STOP?
```

Sets the five (5) sets of the offset stop frequencies.

OFFSet[n] n=1 is the base station test and n=2 is the mobile test. The default is the base station test (1). (cdma2000, W-CDMA mode only)

LIST[m] m=1 is the spectrum emission mask (SEM) mode and m=2 is the adjacent channel power (ACP) mode. The default is the SEM mode (1). (1xEV-DO mode only)

Factory Preset:

Mode	Variant	Offset A	Offset B	Offset C	Offset D	Offset E
cdma2000	BTS	795.0 kHz	1.195 MHz	4.015 MHz	4.0031 MHz	12.50 MHz
	MS	1.995 MHz	4.015 MHz	4.0031 MHz	12.00 MHz	15.00 MHz
W-CDMA	BTS	2.715 MHz	3.515 MHz	4.000 MHz	8.000 MHz	12.50 MHz
	MS	3.485 MHz	7.500 MHz	8.500 MHz	12.00 MHz	15.00 MHz
1xEV-DO	SEM	795.0 kHz	1.995 MHz	4.015 MHz	4.0031 MHz	12.50 MHz
	ACP	765.0 kHz	1.995 MHz	3.125 MHz	4.000 MHz	7.500 MHz

Range: 10.0 kHz to 100.0 MHz

Default Unit: Hz

Remarks: You must be in the cdma2000, W-CDMA, or 1xEV-DO mode to use this command. Use INSTRument:SElect to set the mode.

Spectrum Emission Mask—Offset Relative Attenuation

cdma2000, W-CDMA mode

```
[ :SENSE ] :SEMask:OFFSet [n] :LIST:RATTenuation
<rel_power>,<rel_power>,<rel_power>,<rel_power>,<rel_power>
```

```
[ :SENSe ] :SEMask:OFFSet [n] :LIST:RATTenuation?
```

1xEV-DO mode

```
[ :SENSE ] :SEMask:OFFSet:LIST [m] :RATTenuation
<rel_power>,<rel_power>,<rel_power>,<rel_power>,<rel_power>
```

```
[ :SENSe ] :SEMask:OFFSet:LIST [m] :RATTenuation?
```

Set a relative amount of attenuation for the measurements made at an offset channel. The amount is specified relative to the attenuation required to measure the carrier channel. Since the offset channel power is lower than the carrier channel power, less attenuation is required to measure the offset channel and you get wider dynamic range for the measurement.

You can turn off (not use) specific offset channels with
 [:SENS]:SEM:OFFS[n]:LIST[m]:STAT.

OFFSet[n] n=1 is the base station test and n=2 is the mobile test. The default is the base station test (1). (cdma2000, W-CDMA mode only)

LIST[m] m=1 is the spectrum emission mask (SEM) mode and m=2 is the adjacent channel power (ACP) mode. The default is the SEM mode (1). (1xEV-DO mode only)

Factory Preset:

Mode	Offset A	Offset B	Offset C	Offset D	Offset E
cdma2000	0.00 dB	0.00 dB	0.00 dB	0.00 dB	0.00 dB
W-CDMA	0.00 dB	0.00 dB	0.00 dB	0.00 dB	0.00 dB
1xEV-DO	0.00 dB	0.00 dB	0.00 dB	0.00 dB	0.00 dB

- Range: –40.00 to 0.00 dB, but this relative attenuation cannot exceed the absolute attenuation ranging from 0 to 40 dB.
- Default Unit: dB
- Remarks: Remember that the attenuation that you specify is always relative to the amount of attenuation used for the carrier channel. Selecting negative attenuation means that you want less attenuation used. For example, if the measurement must use 20 dB of attenuation for the carrier measurement and you want to use 12 dB less attenuation for the first offset, you would send the value –12 dB.
- You must be in the cdma2000, W-CDMA, or 1xEV-DO mode to use this command. Use INSTRUMENT:SElect to set the mode.

Spectrum Emission Mask—Offset Frequency Side

cdma2000, W-CDMA mode

```
[ :SENSe] :SEMAsk:OFFSet [n] :LIST:SIDE BOTH | NEGAtive | POSitive,
BOTH | NEGAtive | POSitive, BOTH | NEGAtive | POSitive,
BOTH | NEGAtive | POSitive, BOTH | NEGAtive | POSitive
```

```
[ :SENSe] :SEMAsk:OFFSet [n] :LIST:SIDE?
```

1xEV-DO mode

```
[ :SENSe] :SEMAsk:OFFSet:LIST [m] :SIDE BOTH | NEGAtive | POSitive,
BOTH | NEGAtive | POSitive, BOTH | NEGAtive | POSitive,
BOTH | NEGAtive | POSitive, BOTH | NEGAtive | POSitive
```

```
[ :SENSe] :SEMAsk:OFFSet:LIST [m] :SIDE?
```

Specify which sideband will be measured. You can turn off (not use) specific offsets with [:SENS]:SEM:OFFS[n]:LIST[m]:STAT.

BOTH - both of the negative (lower) and positive (upper) sidebands

NEGAtive - negative (lower) sideband only

POSitive - positive (upper) sideband only

OFFSet[n] n=1 is the base station test and n=2 is the mobile test. The default is the base station test (1). (cdma2000, W-CDMA mode only)

LIST[m] m=1 is the spectrum emission mask (SEM) mode and m=2 is the adjacent channel power (ACP) mode. The default is the SEM mode (1). (1xEV-DO mode only)

Factory Preset:

Mode	Variant	Offset A	Offset B	Offset C	Offset D	Offset E
cdma2000		BOTH	BOTH	BOTH	BOTH	BOTH
W-CDMA		BOTH	BOTH	BOTH	BOTH	BOTH
1xEV-DO	SEM	BOTH	BOTH	BOTH	BOTH	BOTH
	ACP	BOTH	BOTH	BOTH	BOTH	BOTH

Remarks: You must be in the cdma2000, W-CDMA, or 1xEV-DO mode to use this command. Use INSTRUMENT:SElect to set the mode.

Spectrum Emission Mask—Offset Start Absolute Power Limit

cdma2000, W-CDMA mode

```
[ :SENSE ] :SEMask:OFFSet [n] :LIST:STARt:ABSolute
<abs_power>,<abs_power>,<abs_power>,<abs_power>,<abs_power>
```

```
[ :SENSE ] :SEMask:OFFSet [n] :LIST:STARt:ABSolute?
```

1xEV-DO mode

```
[ :SENSE ] :SEMask:OFFSet:LIST [m] :STARt:ABSolute
<abs_power>,<abs_power>,<abs_power>,<abs_power>,<abs_power>
```

```
[ :SENSE ] :SEMask:OFFSet:LIST [m] :STARt:ABSolute?
```

Sets an absolute power level for each offset start limit. The list must contain five (5) entries. If there is more than one offset, the offset closest to the carrier channel comes first in the list.

The fail condition for each offset channel is set by
[:SENS]:SEM:OFFS[n]:LIST[m]:TEST.

You can turn off (not use) specific offset channels with
[:SENS]:SEM:OFFS[n]:LIST[m]:STAT.

The query returns the five (5) sets of the real values currently set to the absolute power test limits.

OFFSet[n] n=1 is the base station test and n=2 is the mobile test. The default is the base station test (1). (cdma2000, W-CDMA mode only)

LIST[m] m=1 is the spectrum emission mask (SEM) mode and m=2 is the adjacent channel power (ACP) mode. The default is the SEM mode (1). (1xEV-DO mode only)

Factory Preset:

Mode	Variant	Offset A	Offset B	Offset C	Offset D	Offset E
cdma2000	BTS	-27.0 dBm	-27.0 dBm	-27.0 dBm	-46.00 dBm	-13.00 dBm
	MS	-70.13 dBm	-70.13 dBm	-35.00 dBm	-13.00 dBm	-13.00 dBm
W-CDMA	BTS	-12.50 dBm	-12.50 dBm	-24.50 dBm	-11.50 dBm	-11.50 dBm
	MS	-69.57 dBm	-54.34 dBm	-54.34 dBm	-54.34 dBm	-54.34 dBm
1xEV-DO	SEM	-27.00 dBm	-27.00 dBm	-27.00 dBm	-46.00 dBm	-13.00 dBm
	ACP	-27.00 dBm	-27.00 dBm	-13.00 dBm	-13.00 dBm	-13.00 dBm

Range: -200.0 dBm to 50.0 dBm

Default Unit: dBm

Remarks: You must be in the cdma2000, W-CDMA, or 1xEV-DO mode to use this command. Use INSTRument:SElect to set the mode.

Spectrum Emission Mask—Offset Start Relative Power Limit

cdma2000, W-CDMA mode

```
[ :SENSE ] :SEMask:OFFSet [n] :LIST:START:RCARrier
<rel_power>, <rel_power>, <rel_power>, <rel_power>, <rel_power>
```

```
[ :SENSE ] :SEMask:OFFSet [n] :LIST:START:RCARrier?
```

1xEV-DO mode

```
[ :SENSE ] :SEMask:OFFSet:LIST [m] :START:RCARrier
<rel_power>, <rel_power>, <rel_power>, <rel_power>, <rel_power>
```

```
[ :SENSE ] :SEMask:OFFSet:LIST [m] :START:RCARrier?
```

Set a relative power level for each offset start limit. The list must contain five (5) entries. If there is more than one offset, the offset closest to the carrier channel comes first in the list.

The fail condition is set by [:SENS]:SEM:OFFS[n]:LIST[m]:TEST for each offset channel test.

You can turn off (not use) specific offset channels with [:SENS]:SEM:OFFS[n]:LIST[m]:STAT.

The query returns the five (5) sets of the real values currently set to the relative power test limits.

OFFSet[n] n=1 is the base station test and n=2 is the mobile test. The default is the base station test (1). (cdma2000, W-CDMA mode only)

LIST[m] m=1 is the spectrum emission mask (SEM) mode and m=2 is the adjacent channel power (ACP) mode. The default is the SEM mode (1). (1xEV-DO mode only)

Factory Preset:

Mode	Variant	Offset A	Offset B	Offset C	Offset D	Offset E
cdma2000	BTS	-45.00 dB	-45.00 dB	-55.00 dB	-55.00 dB	-55.00 dB
	MS	-42.00 dB	-54.00 dB	-54.00 dB	-54.00 dB	-54.00 dB
W-CDMA	BTS	-30.00 dB	-30.00 dB	-30.00 dB	-30.00 dB	-30.00 dB
	MS	-33.73 dB	-34.00 dB	-37.50 dB	-47.50 dB	-47.50 dB
1xEV-DO	SEM	-45.00 dB	-45.00 dB	-55.00 dB	-55.00 dB	-55.00 dB
	ACP	-45.00 dB	-55.00 dB	-55.00 dB	-55.00 dB	-55.00 dB

Range: -150.0 dBm to 50.0 dB

Default Unit: dB

Remarks: You must be in the cdma2000, W-CDMA, or 1xEV-DO mode to use this command. Use INSTRUMENT:SElect to set the mode.

Spectrum Emission Mask—Offset Measurement State

cdma2000, W-CDMA mode

```
[ :SENSE ] :SEMAsk:OFFSet [n] :LIST:STATe
OFF | ON | 0 | 1, OFF | ON | 0 | 1, OFF | ON | 0 | 1, OFF | ON | 0 | 1, OFF | ON | 0 | 1
```

```
[ :SENSE ] :SEMAsk:OFFSet [n] :LIST:STATe?
```

1xEV-DO mode

```
[ :SENSE ] :SEMAsk:OFFSet:LIST [m] :STATe
OFF | ON | 0 | 1, OFF | ON | 0 | 1, OFF | ON | 0 | 1, OFF | ON | 0 | 1, OFF | ON | 0 | 1
```

```
[ :SENSE ] :SEMAsk:OFFSet:LIST [m] :STATe?
```

Define whether or not to execute pass/fail tests at the offset channels. The pass/fail conditions are set by [:SENS]:SEM:OFFS[n]:LIST[m]:ABS or [:SENS]:SEM:OFFS[n]:LIST[m]:RCAR for each offset channel.

OFFSet[n] n=1 is the base station test and n=2 is the mobile test. The default is the base station test (1). (cdma2000, W-CDMA mode only)

LIST[m] m=1 is the spectrum emission mask (SEM) mode and m=2 is the adjacent channel power (ACP) mode. The default is the SEM mode (1). (1xEV-DO mode only)

Factory Preset:

Mode	Variant	Offset A	Offset B	Offset C	Offset D	Offset E
cdma2000	BTS	ON	ON	ON	OFF	OFF
	MS	ON	ON	OFF	OFF	OFF
W-CDMA	BTS	ON	ON	ON	ON	ON
	MS	ON	ON	ON	ON	OFF
1xEV-DO	SEM	ON	ON	ON	OFF	OFF
	ACP	ON	ON	OFF	OFF	OFF

Remarks: You must be in the cdma2000, W-CDMA, or 1xEV-DO mode to use this command. Use INSTRUMENT:SElect to set the mode.

Spectrum Emission Mask—Offset Stop Absolute Power Limit

cdma2000, W-CDMA mode

```
[ :SENSE ] :SEMask:OFFSet [n] :LIST:STOP:ABSolute  
<abs_power>,<abs_power>,<abs_power>,<abs_power>,<abs_power>
```

```
[ :SENSE ] :SEMask:OFFSet [n] :LIST:STOP:ABSolute?
```

1xEV-DO mode

```
[ :SENSE ] :SEMask:OFFSet:LIST [m] :STOP:ABSolute  
<abs_power>,<abs_power>,<abs_power>,<abs_power>,<abs_power>
```

```
[ :SENSE ] :SEMask:OFFSet:LIST [m] :STOP:ABSolute?
```

Set an absolute power level to for each offset stop limit. The list must contain five (5) entries. If there is more than one offset, the offset closest to the carrier channel comes first in the list.

The fail condition is set by [:SENS]:SEM:OFFS[n]:LIST[m]:TEST for each offset channel test.

You can turn off (not use) specific offset channels with [:SENS]:SEM:OFFS[n]:LIST[m]:STAT.

The query returns the five (5) sets of the real values currently set to the offset stop absolute power limits.

OFFSet[n] n=1 is the base station test and n=2 is the mobile test. The default is the base station test (1). (cdma2000, W-CDMA mode only)

LIST[m] m=1 is the spectrum emission mask (SEM) mode and m=2 is the adjacent channel power (ACP) mode. The default is the SEM mode (1). (1xEV-DO mode only)

Factory Preset:

Mode	Variant	Offset A	Offset B	Offset C	Offset D	Offset E
cdma2000	BTS	-27.00 dBm	-27.00 dBm	-27.00 dBm	-46.00 dBm	-13.00 dBm
	MS	-70.13 dBm	-70.13 dBm	-35.00 dBm	-13.00 dBm	-13.00 dBm
W-CDMA	BTS	-12.50 dBm	-24.50 dBm	-24.50 dBm	-11.50 dBm	-11.50 dBm
	MS	-69.57 dBm	-54.34 dBm	-54.34 dBm	-54.34 dBm	-54.34 dBm
1xEV-DO	SEM	-27.00 dBm	-27.00 dBm	-27.00 dBm	-46.00 dBm	-13.00 dBm
	ACP	-27.00 dBm	-27.00 dBm	-13.00 dBm	-13.00 dBm	-13.00 dBm

Range: -200.0 dBm to 50.0 dBm

Default Unit: dBm

Remarks: You must be in the cdma2000, W-CDMA, or 1xEV-DO mode to use this command. Use INSTRUMENT:SElect to set the mode.

Spectrum Emission Mask—Couple Offset Stop Absolute Power Limit

cdma2000, W-CDMA mode

```
[ :SENSE ] :SEMask:OFFSet [n] :LIST:STOP:ABSolute:COUPle  
OFF | ON | 0 | 1, OFF | ON | 0 | 1, OFF | ON | 0 | 1, OFF | ON | 0 | 1, OFF | ON | 0 | 1
```

```
[ :SENSE ] :SEMask:OFFSet [n] :LIST:STOP:ABSolute:COUPle?
```

1xEV-DO mode

```
[ :SENSE ] :SEMask:OFFSet:LIST [m] :STOP:ABSolute:COUPle  
OFF | ON | 0 | 1, OFF | ON | 0 | 1, OFF | ON | 0 | 1, OFF | ON | 0 | 1, OFF | ON | 0 | 1
```

```
[ :SENSE ] :SEMask:OFFSet:LIST [m] :STOP:ABSolute:COUPle?
```

Define whether or not to couple the offset stop absolute power limit to the offset start absolute power limit for each offset channel.

You can turn off (not use) specific offset channels with
[:SENS]:SEM:OFFS[n]:LIST[m]:STAT.

OFFSet[n] n=1 is the base station test and n=2 is the mobile test. The default is the base station test (1). (cdma2000, W-CDMA mode only)

LIST[m] m=1 is the spectrum emission mask (SEM) mode and m=2 is the adjacent channel power (ACP) mode. The default is the SEM mode (1). (1xEV-DO mode only)

Factory Preset:

Mode	Variant	Offset A	Offset B	Offset C	Offset D	Offset E
cdma2000	BTS	ON	ON	ON	ON	ON
	MS	ON	ON	ON	ON	ON
W-CDMA	BTS	ON	OFF	ON	ON	ON
	MS	ON	ON	ON	ON	ON
1xEV-DO	SEM	ON	ON	ON	ON	ON
	ACP	ON	ON	ON	ON	ON

Remarks: You must be in the cdma2000, W-CDMA, or 1xEV-DO mode to use this command. Use INSTRument:SElect to set the mode.

Spectrum Emission Mask—Offset Stop Relative Power Limit

cdma2000, W-CDMA mode

```
[ :SENSe] :SEMask:OFFSet [n] :LIST:STOP:RCARrier
<rel_power>, <rel_power>, <rel_power>, <rel_power>, <rel_power>
```

```
[ :SENSe] :SEMask:OFFSet [n] :LIST:STOP:RCARrier?
```

1xEV-DO mode

```
[ :SENSe] :SEMask:OFFSet:LIST [m] :STOP:RCARrier
<rel_power>, <rel_power>, <rel_power>, <rel_power>, <rel_power>
```

```
[ :SENSe] :SEMask:OFFSet:LIST [m] :STOP:RCARrier?
```

Set a relative power level for each offset stop limit. The list must contain five (5) entries. If there is more than one offset, the offset closest to the carrier channel comes first in the list.

The fail condition is set by [:SENS]:SEM:OFFS[n]:LIST[m]:TEST for each offset channel.

You can turn off (not use) specific offset channels with [:SENS]:SEM:OFFS[n]:LIST[m]:STAT.

The query returns the five (5) sets of the real values currently set to the offset stop relative power limits.

OFFSet[n] n=1 is the base station test and n=2 is the mobile test. The default is the base station test (1). (cdma2000, W-CDMA mode only)

LIST[m] m=1 is the spectrum emission mask (SEM) mode and m=2 is the adjacent channel power (ACP) mode. The default is the SEM mode (1). (1xEV-DO mode only)

Factory Preset:

Mode	Variant	Offset A	Offset B	Offset C	Offset D	Offset E
cdma2000	BTS	-45.00 dB	-45.00 dB	-55.00 dB	-55.00 dB	-55.00 dB
	MS	-42.00 dB	-54.00 dB	-54.00 dB	-54.00 dB	-54.00 dB
W-CDMA	BTS	-30.00 dB	-30.00 dB	-30.00 dB	-30.00 dB	-30.00 dB
	MS	-48.28 dB	-37.50 dB	-47.50 dB	-47.50 dB	-47.50 dB
1xEV-DO	SEM	-45.00 dB	-45.00 dB	-55.00 dB	-55.00 dB	-55.00 dB
	ACP	-45.00 dB	-55.00 dB	-55.00 dB	-55.00 dB	-55.00 dB

Range: -150.0 dBm to 50.0 dB

Default Unit: dB

Remarks: You must be in the cdma2000, W-CDMA, or 1xEV-DO mode to use this command. Use INSTRUMENT:SELEct to set the mode.

Spectrum Emission Mask—Couple Offset Stop Relative Power Limit

cdma2000, W-CDMA mode

```
[ :SENSE ] :SEMask:OFFSet [n] :LIST:STOP:RCARrier:COUPle  
OFF | ON | 0 | 1, OFF | ON | 0 | 1, OFF | ON | 0 | 1, OFF | ON | 0 | 1, OFF | ON | 0 | 1
```

```
[ :SENSE ] :SEMask:OFFSet [n] :LIST:STOP:RCARrier:COUPle?
```

1xEV-DO mode

```
[ :SENSE ] :SEMask:OFFSet:LIST [m] :STOP:RCARrier:COUPle  
OFF | ON | 0 | 1, OFF | ON | 0 | 1, OFF | ON | 0 | 1, OFF | ON | 0 | 1, OFF | ON | 0 | 1
```

```
[ :SENSE ] :SEMask:OFFSet:LIST [m] :STOP:RCARrier:COUPle?
```

Define whether or not to couple the offset stop relative power limit to the offset start relative power limit for each offset channel.

You can turn off (not use) specific offset channels with
[:SENS]:SEM:OFFS[n]:LIST[m]:STAT.

OFFSet[n] n=1 is the base station test and n=2 is the mobile test. The default is the base station test (1). (cdma2000, W-CDMA mode only)

LIST[m] m=1 is the spectrum emission mask (SEM) mode and m=2 is the adjacent channel power (ACP) mode. The default is the SEM mode (1). (1xEV-DO mode only)

Factory Preset:

Mode	Variant	Offset A	Offset B	Offset C	Offset D	Offset E
cdma2000	BTS	ON	ON	ON	ON	ON
	MS	ON	ON	ON	ON	ON
W-CDMA	BTS	ON	ON	ON	ON	ON
	MS	OFF	OFF	OFF	ON	ON
1xEV-DO	SEM	ON	ON	ON	ON	ON
	ACP	ON	ON	ON	ON	ON

Remarks: You must be in the cdma2000, W-CDMA, or 1xEV-DO mode to use this command. Use INSTRUMENT:SElect to set the mode.

Spectrum Emission Mask—Offset Channel Fail Condition

cdma2000, W-CDMA mode

```
[ :SENSE ] :SEMAsk:OFFSet [n] :LIST:TEST
ABSolute | AND | OR | RELative, ABSolute | AND | OR | RELative,
ABSolute | AND | OR | RELative, ABSolute | AND | OR | RELative,
ABSolute | AND | OR | RELative
```

```
[ :SENSe ] :SEMAsk:OFFSet [n] :LIST:TEST?
```

1xEV-DO mode

```
[ :SENSE ] :SEMAsk:OFFSet:LIST [m] :TEST
ABSolute | AND | OR | RELative, ABSolute | AND | OR | RELative,
ABSolute | AND | OR | RELative, ABSolute | AND | OR | RELative,
ABSolute | AND | OR | RELative
```

```
[ :SENSe ] :SEMAsk:OFFSet:LIST [m] :TEST?
```

Define one of the fail conditions for each offset channel limit test to be done. The absolute or relative power limit value for each offset channel is set by [:SENS]:SEM:OFFS[n]:LIST[m]:ABS or [:SENS]:SEM:OFFS[n]:LIST[m]:RCAR.

You can turn off (not use) specific offset channels with [:SENS]:SEM:OFFS[n]:LIST[m]:STAT.

OFFSet[n] n=1 is the base station test and n=2 is the mobile test. The default is the base station test (1). (cdma2000, W-CDMA mode only)

LIST[m] m=1 is the spectrum emission mask (SEM) mode and m=2 is the adjacent channel power (ACP) mode. The default is the SEM mode (1). (1xEV-DO mode only)

The fail condition that can be set for each offset channel include:

- AND - Tests the measurement result for an offset channel against both the absolute power limit and the relative power limit. If it fails, then returns a failure for that measurement test.
- ABSolute - Tests the measurement result for an offset channel against the absolute power limit. If it fails, then returns a failure for that measurement test.
- OR - Tests the measurement result for an offset channel against the absolute power limit OR the relative power limit. If either test fails, then returns a failure for that measurement test.

- RELative - Tests the measurement result for an offset channel against the relative power limit. If it fails, then returns a failure for that measurement test.

Factory Preset:

Mode	Variant	Offset A	Offset B	Offset C	Offset D	Offset E
cdma2000	BTS	REL	REL	REL	ABS	REL
	MS	AND	AND	ABS	REL	REL
W-CDMA	BTS	ABS	ABS	ABS	ABS	ABS
	MS	AND	AND	AND	AND	AND
1xEV-DO	SEM	REL	REL	REL	ABS	REL
	ACP	REL	REL	ABS	REL	REL

Remarks: You must be in the cdma2000, W-CDMA, or 1xEV-DO mode to use this command. Use INSTRument:SElect to set the mode.

Spectrum Emission Mask—Region Resolution Bandwidth

cdma2000, W-CDMA mode

```
[ :SENSE ] :SEMAsk:REGion [n] :LIST:BA NDwidth | BWIDth
<res_bw>, <res_bw>, <res_bw>, <res_bw>, <res_bw>
```

```
[ :SENSE ] :SEMAsk:REGion [n] :LIST:BA NDwidth | BWIDth?
```

1xEV-DO mode

```
[ :SENSE ] :SEMAsk:REGion:LIST:BA NDwidth | BWIDth
<res_bw>, <res_bw>, <res_bw>, <res_bw>, <res_bw>
```

```
[ :SENSE ] :SEMAsk:REGion:LIST:BA NDwidth | BWIDth?
```

Define the region resolution bandwidth(s) for spectrum emission measurements. The list must contain five (5) entries. You can turn off (not use) specific regions with [:SENS]:SEM:REG[n]:LIST:STAT.

REGion[n] n=1 is the base station test and n=2 is the mobile test. The default is the base station test (1). (cdma2000, W-CDMA mode only)

Factory Preset
and *RST: Auto coupled, except cdma2000, see below.

Mode	Variant	Region A	Region B	Region C	Region D	Region E
cdma2000	BTS	1.000 MHz	300.0 kHz	100.0 kHz	100.0 kHz	4.000 MHz
	MS	300.0 kHz	100.0 kHz	100.0 kHz	100.0 kHz	12.00 MHz

Range: 300 Hz to 7.5 MHz

Default Unit: Hz

Remarks: You must be in the cdma2000, W-CDMA, or 1xEV-DO mode to use this command. Use INSTRUMENT:SElect to set the mode.

Spectrum Emission Mask—Auto Region Resolution Bandwidth

cdma2000, W-CDMA mode

```
[ :SENSe] :SEMAsk:REGion [n] :LIST:BA NDwidth | BWIDth:AUTO  
OFF | ON | 0 | 1, OFF | ON | 0 | 1, OFF | ON | 0 | 1, OFF | ON | 0 | 1, OFF | ON | 0 | 1
```

```
[ :SENSe] :SEMAsk:REGion [n] :LIST:BA NDwidth | BWIDth:AUTO?
```

1xEV-DO mode

```
[ :SENSe] :SEMAsk:REGion:LIST:BA NDwidth | BWIDth:AUTO  
OFF | ON | 0 | 1, OFF | ON | 0 | 1, OFF | ON | 0 | 1, OFF | ON | 0 | 1, OFF | ON | 0 | 1
```

```
[ :SENSe] :SEMAsk:REGion:LIST:BA NDwidth | BWIDth:AUTO?
```

Set the auto mode of the region step frequency.

Set the auto mode to determine the region resolution bandwidth to On or Off.

OFF - enter a value to set the resolution bandwidth for a region channel, referring to [:SENS]:SEM:REG[n]:LIST:BAND | BWID.

ON - the resolution bandwidth for a region channel is automatically set according to the region start and stop frequencies.

REGion[n] n=1 is the base station test and n=2 is the mobile test. The default is the base station test (1). (cdma2000, W-CDMA mode only)

Factory Preset and *RST:

Mode	Region A	Region B	Region C	Region D	Region E
cdma2000	OFF	OFF	OFF	OFF	OFF
W-CDMA	ON	ON	ON	ON	ON
1xEV-DO	ON	ON	ON	ON	ON

Remarks: You must be in the cdma2000, W-CDMA, or 1xEV-DO mode to use this command. Use INSTRUMENT:SElect to set the mode.

Spectrum Emission Mask—Region Start Frequency

cdma2000, W-CDMA mode

```
[ :SENSE ] :SEMask:REGION [n] :LIST:FREQUENCY:START
<f_region>,<f_region>,<f_region>,<f_region>,<f_region>
```

```
[ :SENSE ] :SEMask:REGION [n] :LIST:FREQUENCY:START?
```

1xEV-DO mode

```
[ :SENSE ] :SEMask:REGION:LIST:FREQUENCY:START
<f_region>,<f_region>,<f_region>,<f_region>,<f_region>
```

```
[ :SENSE ] :SEMask:REGION:LIST:FREQUENCY:START?
```

Set the five (5) sets of the region start frequencies.

REGION[n] n=1 is the base station test and n=2 is the mobile test. The default is the base station test (1). (cdma2000, W-CDMA mode only)

Factory Preset and *RST:

Mode	Variant	Region A	Region B	Region C	Region D	Region E
cdma2000	BTS	1920.5 MHz	1893.65 MHz	876.05 MHz	921.05 MHz	800.0 MHz
	MS	1920.5 MHz	925.05 MHz	935.05 MHz	1805.05 MHz	800.0 MHz
W-CDMA	n/a	1920.0 MHz	1893.5 MHz	2100.0 MHz	2175.0 MHz	800.0 MHz
1xEV-DO	n/a	1920.0 MHz	1893.5 MHz	2100.0 MHz	2175.0 MHz	800.0 MHz

Range: 329.0 MHz to 3.678 GHz

Default Unit: Hz

Remarks: You must be in the cdma2000, W-CDMA, or 1xEV-DO mode to use this command. Use INSTRUMENT:SElect to set the mode.

Spectrum Emission Mask—Region Step Frequency

cdma2000, W-CDMA mode

```
[ :SENSe] :SEMask:REGion [n] :LIST:FREQuency:STEP
<f_region>, <f_region>, <f_region>, <f_region>, <f_region>
```

```
[ :SENSe] :SEMask:REGion [n] :LIST:FREQuency:STEP?
```

1xEV-DO mode

```
[ :SENSe] :SEMask:REGion:LIST:FREQuency:STEP
<f_region>, <f_region>, <f_region>, <f_region>, <f_region>
```

```
[ :SENSe] :SEMask:REGion:LIST:FREQuency:STEP?
```

Sets the five (5) sets of the region step frequencies.

REGion[n] n=1 is the base station test and n=2 is the mobile test. The default is the base station test (1). (cdma2000, W-CDMA mode only)

Factory Preset: No valid value as the default is set to Auto. See [:SENS]:SEM:REG[n]:LIST:FREQ:STEP:AUTO.

Range: 100 Hz to 7.5 MHz

The minimum value is determined to be equal to or greater than one 2000th (1/2000) of the frequency difference derived from (Stop Freq – Start Freq).

Default Unit: Hz

Remarks: You must be in the cdma2000, W-CDMA, or 1xEV-DO mode to use this command. Use INSTRUMENT:SElect to set the mode.

Spectrum Emission Mask—Auto Region Step Frequency

cdma2000, W-CDMA mode

```
[ :SENSe ] :SEMask:REGion [n] :LIST:FREQuency:STEP:AUTO  

OFF | ON | 0 | 1, OFF | ON | 0 | 1, OFF | ON | 0 | 1, OFF | ON | 0 | 1, OFF | ON | 0 | 1
```

```
[ :SENSe ] :SEMask:REGion [n] :LIST:FREQuency:STEP:AUTO?
```

1xEV-DO mode

```
[ :SENSe ] :SEMask:REGion:LIST:FREQuency:STEP:AUTO  

OFF | ON | 0 | 1, OFF | ON | 0 | 1, OFF | ON | 0 | 1, OFF | ON | 0 | 1, OFF | ON | 0 | 1
```

```
[ :SENSe ] :SEMask:REGion:LIST:FREQuency:STEP:AUTO?
```

Set the auto mode to determine the region step frequency to On or Off.

OFF - enter a value to set the step frequency for a region channel, referring to [:SENSe]:SEMask:REGion[n]:LIST:FREQ:STEP.

ON - the step frequency for a region channel is automatically set according to the region start and stop frequencies.

REGion[n] n=1 is the base station test and n=2 is the mobile test. The default is the base station test (1). (cdma2000, W-CDMA mode only)

Factory Preset:

Mode	Region A	Region B	Region C	Region D	Region E
cdma2000	ON	ON	ON	ON	ON
W-CDMA	ON	ON	ON	ON	ON
1xEV-DO	ON	ON	ON	ON	ON

Remarks: You must be in the cdma2000, W-CDMA, or 1xEV-DO mode to use this command. Use INSTRument:SElect to set the mode.

Spectrum Emission Mask—Region Stop Frequency

cdma2000, W-CDMA mode

```
[ :SENSe] :SEMask:REGion [n] :LIST:FREQuency:STOP
<f_region>,<f_region>,<f_region>,<f_region>,<f_region>
```

```
[ :SENSe] :SEMask:REGion [n] :LIST:FREQuency:STOP?
```

1xEV-DO mode

```
[ :SENSe] :SEMask:REGion:LIST:FREQuency:STOP
<f_region>,<f_region>,<f_region>,<f_region>,<f_region>
```

```
[ :SENSe] :SEMask:REGion:LIST:FREQuency:STOP?
```

Sets the five (5) sets of the region stop frequencies.

REGion[n] n=1 is the base station test and n=2 is the mobile test.
The default is the base station test (1). (cdma2000,
W-CDMA mode only)

Factory Preset and *RST:

Mode	Variant	Region A	Region B	Region C	Region D	Region E
cdma2000	BTS	1980.5 MHz	1919.75 MHz	915.05 MHz	960.05 MHz	1000.0 MHz
	MS	1980.5 MHz	935.05 MHz	960.05 MHz	1880.05 MHz	1000.0 MHz
W-CDMA	n/a	1980.0 MHz	1919.6 MHz	2105.0 MHz	2180.0 MHz	1000.0 MHz
1xEV-DO	n/a	1980.0 MHz	1919.6 MHz	2105.0 MHz	2180.0 MHz	1000.0 MHz

Range: 329.0 MHz to 3.678 MHz

Default Unit: Hz

Remarks: You must be in the cdma2000, W-CDMA, or 1xEV-DO mode to use this command. Use INSTRument:SElect to set the mode.

Spectrum Emission Mask—Region Relative Attenuation

cdma2000, W-CDMA mode

```
[ :SENSE ] :SEMask:REGion [n] :LIST:RATTenuation
<rel_power>, <rel_power>, <rel_power>, <rel_power>, <rel_power>
```

```
[ :SENSe ] :SEMask:REGion [n] :LIST:RATTenuation?
```

1xEV-DO mode

```
[ :SENSE ] :SEMask:REGion:LIST:RATTenuation
<rel_power>, <rel_power>, <rel_power>, <rel_power>, <rel_power>
```

```
[ :SENSe ] :SEMask:REGion:LIST:RATTenuation?
```

Set a relative amount of attenuation for measurements made at a region. The amount is specified relative to the attenuation required to measure the carrier channel power. Since the region channel power is lower than the carrier channel power, less attenuation is required to measure the region channel and you get wider dynamic range for the measurement.

You can turn off (not use) specific regions with
[:SENS]:SEM:REG[n]:LIST:STAT.

REGion[n] n=1 is the base station test and n=2 is the mobile test.
The default is the base station test (1). (cdma2000,
W-CDMA mode only)

Factory Preset:

Mode	Variant	Region A	Region B	Region C	Region D	Region E
cdma2000	BTS	0.00 dB	0.00 dB	0.00 dB	0.00 dB	0.00 dB
	MS	0.00 dB	0.00 dB	0.00 dB	0.00 dB	0.00 dB
W-CDMA	n/a	0.00 dB	0.00 dB	0.00 dB	0.00 dB	0.00 dB
1xEV-DO	n/a	0.00 dB	0.00 dB	0.00 dB	0.00 dB	0.00 dB

Range: –40.00 to 0.00 dB, but this relative attenuation cannot exceed the absolute attenuation ranging from 0.00 to 40.00 dB.

Remarks: Remember that the attenuation that you specify is always relative to the amount of attenuation used for the carrier channel. Selecting negative attenuation means that you want less attenuation used. For example, if the measurement must use 20 dB of attenuation for the carrier measurement and you want to use 12 dB less attenuation for the first region, you would send the value –12 dB.

You must be in the cdma2000, W-CDMA, or 1xEV-DO mode to use this command. Use INSTRument:SElect to set the mode.

Spectrum Emission Mask—Region Start Absolute Power Limit

cdma2000, W-CDMA (3GPP) mode

```
[ :SENSe] :SEMAsk:REGion [n] :LIST:STARt:ABSolute
<abs_power>, <abs_power>, <abs_power>, <abs_power>, <abs_power>
```

```
[ :SENSe] :SEMAsk:REGion [n] :LIST:STARt:ABSolute?
```

1xEV-DO mode

```
[ :SENSe] :SEMAsk:REGion:LIST:STARt:ABSolute
<abs_power>, <abs_power>, <abs_power>, <abs_power>, <abs_power>
```

```
[ :SENSe] :SEMAsk:REGion:LIST:STARt:ABSolute?
```

Set an absolute power level for each region start limit. The list must contain five (5) entries. If there is more than one region, the region closest to the carrier channel comes first in the list.

The fail condition for each region channel is set by [:SENS]:SEM:REG[n]:LIST:TEST.

You can turn off (not use) specific regions with [:SENS]:SEM:REG[n]:LIST:STAT.

The query returns the five (5) sets of the real values currently set to the absolute power test limits.

REGion[n] n=1 is the base station test and n=2 is the mobile test. The default is the base station test (1). (cdma2000, W-CDMA mode only)

Factory Preset:

Mode	Variant	Region A	Region B	Region C	Region D	Region E
cdma2000	BTS	-86.00 dBm	-41.00 dBm	-98.00 dBm	-57.00 dBm	-50.00 dBm
	MS	-41.00 dBm	-67.00 dBm	-79.00 dBm	-71.00 dBm	-50.00 dBm
W-CDMA		-50.00 dBm	-50.00 dBm	-50.00 dBm	-50.00 dBm	-50.00 dBm
1xEV-DO		-50.00 dBm	-50.00 dBm	-50.00 dBm	-50.00 dBm	-50.00 dBm

Range: -200.00 dBm to 50.00 dBm

Default Unit: dBm

Remarks: You must be in the cdma2000, W-CDMA, or 1xEV-DO mode to use this command. Use INSTRUMENT:SElect to set the mode.

Spectrum Emission Mask—Region Start Relative Power Limit

cdma2000, W-CDMA mode

```
[ :SENSe ] :SEMAsk:REGion [n] :LIST:START:RCARrier
<rel_power>, <rel_power>, <rel_power>, <rel_power>, <rel_power>
```

```
[ :SENSe ] :SEMAsk:REGion [n] :LIST:START:RCARrier?
```

1xEV-DO mode

```
[ :SENSe ] :SEMAsk:REGion:LIST:START:RCARrier
<rel_power>, <rel_power>, <rel_power>, <rel_power>, <rel_power>
```

```
[ :SENSe ] :SEMAsk:REGion:LIST:START:RCARrier?
```

Set a relative power level for each region start limit. The list must contain five (5) entries. If there is more than one region, the region closest to the carrier channel comes first in the list.

The fail condition is set by [:SENS]:SEM:REG[n]:LIST:TEST for each region test.

You can turn off (not use) specific regions with [:SENS]:SEM:REG[n]:LIST:STAT.

The query returns the five (5) sets of the real values currently set to the relative power test limits.

REGion[n] n=1 is the base station test and n=2 is the mobile test.
The default is the base station test (1). (cdma2000, W-CDMA mode only)

Factory Preset:

Mode	Region A	Region B	Region C	Region D	Region E
cdma2000	-30.00 dB	-30.00 dB	-30.00 dB	-30.00 dB	-30.00 dB
W-CDMA	-30.00 dB	-30.00 dB	-30.00 dB	-30.00 dB	-30.00 dB
1xEV-DO	-30.00 dB	-30.00 dB	-30.00 dB	-30.00 dB	-30.00 dB

Range: -150.00 dBm to 50.00 dB

Default Unit: dB

Remarks: You must be in the cdma2000, W-CDMA, or 1xEV-DO mode to use this command. Use INSTRUMENT:SElect to set the mode.

Spectrum Emission Mask—Control Region List State

cdma2000, W-CDMA mode

```
[ :SENSe] :SEMAsk:REGion [n] :LIST:STATe
OFF | ON | 0 | 1, OFF | ON | 0 | 1, OFF | ON | 0 | 1, OFF | ON | 0 | 1, OFF | ON | 0 | 1
```

```
[ :SENSe] :SEMAsk:REGion [n] :LIST:STATe?
```

1xEV-DO mode

```
[ :SENSe] :SEMAsk:REGion:LIST:STATe
OFF | ON | 0 | 1, OFF | ON | 0 | 1, OFF | ON | 0 | 1, OFF | ON | 0 | 1, OFF | ON | 0 | 1
```

```
[ :SENSe] :SEMAsk:REGion:LIST:STATe?
```

Define whether or not to execute pass/fail tests at custom region frequencies. The pass/fail conditions are set by [:SENS]:SEM:REG[n]:LIST:ABS or [:SENS]:SEM:REG[n]:LIST:RCAR for each region.

REGion[n] n=1 is the base station test and n=2 is the mobile test. The default is the base station test (1). (cdma2000, W-CDMA mode only)

Factory Preset and *RST:

Mode	Region A	Region B	Region C	Region D	Region E
cdma2000	ON	ON	OFF	OFF	OFF
W-CDMA	ON	ON	ON	OFF	OFF
1xEV-DO	ON	ON	ON	OFF	OFF

Remarks: You must be in the cdma2000, W-CDMA, or 1xEV-DO mode to use this command. Use INSTRUMENT:SElect to set the mode.

Spectrum Emission Mask—Region Stop Absolute Power Limit

cdma2000, W-CDMA mode

```
[ :SENSE ] :SEMask:REGion [n] :LIST:STOP:ABSolute
<abs_power>, <abs_power>, <abs_power>, <abs_power>, <abs_power>
```

```
[ :SENSE ] :SEMask:REGion [n] :LIST:STOP:ABSolute?
```

1xEV-DO mode

```
[ :SENSE ] :SEMask:REGion:LIST:STOP:ABSolute
<abs_power>, <abs_power>, <abs_power>, <abs_power>, <abs_power>
```

```
[ :SENSE ] :SEMask:REGion:LIST:STOP:ABSolute?
```

Set an absolute power level for each region stop limit. The list must contain five (5) entries. If there is more than one region, the region closest to the carrier channel comes first in the list.

The fail condition is set by [:SENS]:SEM:REG[n]:LIST:TEST for each region test.

You can turn off (not use) specific regions with [:SENS]:SEM:REG[n]:LIST:STAT.

The query returns the five (5) sets of the real values currently set to the region stop absolute power limits.

REGion[n] n=1 is the base station test and n=2 is the mobile test. The default is the base station test (1). (cdma2000, W-CDMA mode only)

Factory Preset and *RST:

Mode	Variant	Region A	Region B	Region C	Region D	Region E
cdma2000	BTS	-86.00 dBm	-41.00 dBm	-98.00 dBm	-57.00 dBm	-50.00 dBm
	MS	-41.00 dBm	-67.00 dBm	-79.00 dBm	-71.00 dBm	-50.00 dBm
W-CDMA	n/a	-50.00 dBm	-50.00 dBm	-50.00 dBm	-50.00 dBm	-50.00 dBm
1xEV-DO	n/a	-50.00 dBm	-50.00 dBm	-50.00 dBm	-50.00 dBm	-50.00 dBm

Range: -200.00 dBm to 50.00 dBm

Unit: dBm

Remarks: You must be in the cdma2000, W-CDMA, or 1xEV-DO mode to use this command. Use INSTRUMENT:SElect to set the mode.

Spectrum Emission Mask—Couple Region Stop Absolute Power Limit

```
[ :SENSe] :SEMAsk:REGion [n] :LIST:STOP:ABSolute:COUPLE  
OFF|ON|0|1{ ,OFF|ON|0|1 }
```

```
[ :SENSe] :SEMAsk:REGion [n] :LIST:STOP:ABSolute:COUPLE?
```

Define whether or not to couple the region stop absolute power limit to the region start absolute power limit for each region.

You can turn off (not use) specific regions with
[:SENS]:SEM:REG[n]:LIST:STAT.

REGion[n] n=1 is the base station test and n=2 is the mobile test. The default is the base station test (1). (cdma2000, W-CDMA mode only)

Factory Preset:

Mode	Region A	Region B	Region C	Region D	Region E
cdma2000	ON	ON	ON	ON	ON
W-CDMA	ON	ON	ON	ON	ON
1xEV-DO	ON	ON	ON	ON	ON

Remarks: You must be in the cdma2000, W-CDMA, or 1xEV-DO mode to use this command. Use INSTRUMENT:SElect to set the mode.

Spectrum Emission Mask—Region Stop Relative Power Limit

cdma2000, W-CDMA mode

```
[ :SENSe] :SEMAsk:REGion[n] :LIST:STOP:RCARrier
<rel_power>,<rel_power>,<rel_power>,<rel_power>,<rel_power>
```

```
[ :SENSe] :SEMAsk:REGion[n] :LIST:STOP:RCARrier?
```

1xEV-DO mode

```
[ :SENSe] :SEMAsk:REGion:LIST:STOP:RCARrier
<rel_power>,<rel_power>,<rel_power>,<rel_power>,<rel_power>
```

```
[ :SENSe] :SEMAsk:REGion:LIST:STOP:RCARrier?
```

Set a relative power level for each region stop limit. The list must contain five (5) entries. If there is more than one region, the region closest to the carrier channel comes first in the list.

The fail condition is set by [:SENS]:SEM:REG[n]:LIST[m]:TEST for each region.

You can turn off (not use) specific regions with [:SENS]:SEM:REG[n]:LIST:STAT.

The query returns the five (5) sets of the real values currently set to the region stop relative power limits.

REGion[n] n=1 is the base station test and n=2 is the mobile test. The default is the base station test (1). (cdma2000, W-CDMA mode only)

Factory Preset:

Mode	Region A	Region B	Region C	Region D	Region E
cdma2000	-30.00 dB	-30.00 dB	-30.00 dB	-30.00 dB	-30.00 dB
W-CDMA	-30.00 dB	-30.00 dB	-30.00 dB	-30.00 dB	-30.00 dB
1xEV-DO	-30.00 dB	-30.00 dB	-30.00 dB	-30.00 dB	-30.00 dB

Range: -150.00 dBm to 50.00 dB

Default Unit: dB

Remarks: You must be in the cdma2000, W-CDMA, or 1xEV-DO mode to use this command. Use INSTRument:SElect to set the mode.

Spectrum Emission Mask—Couple Region Stop Relative Power Limit

cdma2000, W-CDMA mode

```
[ :SENSE ] :SEMask:REGion [n] :LIST:STOP:RCARrier:COUple
OFF | ON | 0 | 1, OFF | ON | 0 | 1, OFF | ON | 0 | 1, OFF | ON | 0 | 1, OFF | ON | 0 | 1
```

```
[ :SENSe ] :SEMask:REGion [n] :LIST:STOP:RCARrier:COUple?
```

1xEV-DO mode

```
[ :SENSe ] :SEMask:REGion:LIST:STOP:RCARrier:COUple
OFF | ON | 0 | 1, OFF | ON | 0 | 1, OFF | ON | 0 | 1, OFF | ON | 0 | 1, OFF | ON | 0 | 1
```

```
[ :SENSe ] :SEMask:REGion:LIST:STOP:RCARrier:COUple?
```

Define whether or not to couple the region stop relative power limit to the region start relative power limit for each region.

You can turn off (not use) specific regions with
[:SENS]:SEM:REG[n]:LIST:STAT.

REGion[n] n=1 is the base station test and n=2 is the mobile test.
The default is the base station test (1). (cdma2000,
W-CDMA mode only)

Factory Preset:

Mode	Region A	Region B	Region C	Region D	Region E
cdma2000	ON	ON	ON	ON	ON
W-CDMA	ON	ON	ON	ON	ON
1xEV-DO	ON	ON	ON	ON	ON

Remarks: You must be in the cdma2000, W-CDMA, or 1xEV-DO mode to use this command. Use INSTRument:SElect to set the mode.

Spectrum Emission Mask—Region Limit Test Fail Condition

cdma2000, W-CDMA mode

```
[ :SENSe ] :SEMAsk:REGion [n] :LIST:TEST
ABSolute |AND| OR |RELative,
ABSolute |AND| OR |RELative,ABSolute |AND| OR |RELative,
ABSolute |AND| OR |RELative,ABSolute |AND| OR |RELative

[ :SENSe ] :SEMAsk:REGion [n] :LIST:TEST?
```

1xEV-DO mode

```
[ :SENSe ] :SEMAsk:REGion:LIST:TEST ABSolute |AND| OR |RELative,
ABSolute |AND| OR |RELative,ABSolute |AND| OR |RELative,
ABSolute |AND| OR |RELative,ABSolute |AND| OR |RELative

[ :SENSe ] :SEMAsk:REGion:LIST:TEST?
```

Define one of the fail conditions for each region limit test to be done. The absolute or relative test limit value for each region is set by [:SENS]:SEM:REG[n]:LIST:ABS or [:SENS]:SEM:REG[n]:LIST:RCAR.

You can turn off (not use) specific regions with [:SENS]:SEM:REG[n]:LIST[m]:STAT.

REGion[n] n=1 is the base station test and n=2 is the mobile test.
 The default is the base station test (1). (cdma2000,
 W-CDMA mode only)

The fail condition that can be set for each region test include:

- **AND** - Tests the measurement result for a region against both the absolute power limit and the relative power limit. If it fails, then returns a failure for that measurement test.
- **ABSolute** - Tests the measurement result for a region against the absolute power limit. If it fails, then returns a failure for that measurement test.
- **OR** - Tests the measurement result for a region against the absolute power limit OR the relative power limit. If either test fails, then returns a failure for that measurement test.
- **RELative** - Tests the measurement result for a region against the relative power limit. If it fails, then returns a failure for that measurement test.

Factory Preset:

Mode	Region A	Region B	Region C	Region D	Region E
cdma2000	ABS	ABS	ABS	ABS	ABS
W-CDMA	ABS	ABS	ABS	ABS	ABS
1xEV-DO	ABS	ABS	ABS	ABS	ABS

Remarks: You must be in the cdma2000, W-CDMA, or 1xEV-DO mode to use this command. Use INSTRUMENT:SElect to set the mode.

Spectrum Emission Mask—Spectrum Segment

`[:SENSe] :SEMask :SEGment OFFSet | REGION`

`[:SENSe] :SEMask :SEGment ?`

Set the frequency spectrum measurement segment to either the offset channels with relative frequencies or the regions with absolute frequencies.

Factory Preset: OFFset

Remarks: You must be in the cdma2000, W-CDMA, or 1xEV-DO mode to use this command. Use INSTRUMENT:SElect to set the mode.

Spectrum Emission Mask—Measurement Interval

`[:SENSe] :SEMask :SWEep :TIME <time> | <no. of chips>`

`[:SENSe] :SEMask :SWEep :TIME ?`

Specify the time length in μ s or number of chips, for the measurement interval that is the data acquisition time for each bin.

Factory Preset: 1 ms

182.3 μ s or 224 chips (for 1xEV-DO)

Range: 100 μ s to 10 ms

10.0 μ s to 10.0 ms or 12.3 to 12300 chips (for 1xEV-DO)

Default Unit: seconds

Remarks: You must be in the cdma2000, W-CDMA, or 1xEV-DO mode to use this command. Use INSTRUMENT:SElect to set the mode.

Spectrum Emission Mask—Trigger Source

```
[ :SENSe ] :SEMask:TRIGger:SOURce  
EXTernal [1] | EXTernal2 | FRAMe | IMMEDIATE | LINE
```

```
[ :SENSe ] :SEMask:TRIGger:SOURce?
```

Select one of the trigger sources used to control the data acquisitions.

EXTernal 1 – front-panel external trigger input

EXTernal 2 – rear-panel external trigger input

FRAMe – internal frame trigger

IMMEDIATE – the next data acquisition is immediately taken, capturing the signal asynchronously (also called free run).

LINE – power line

Factory Preset: IMMEDIATE

Remarks: You must be in the cdma2000, W-CDMA, or 1xEV-DO mode to use this command. Use INSTRUMENT:SELECT to set the mode.

Spectrum Emission Mask—Power Reference

```
[ :SENSe ] :SEMask:TYPE PSDRef | TPreF
```

```
[ :SENSe ] :SEMask:TYPE?
```

Set the power measurement reference type. This allows you to make absolute and relative power measurements of either total power or the power normalized to the measurement bandwidth.

PSDRef - the power spectral density is used as the power reference

TPreF - the total power is used as the power reference

Factory Preset: TPreF

Remarks: You must be in the cdma2000, W-CDMA, 1xEV-DO mode to use this command. Use INSTRUMENT:SELECT to set the mode.

Spectrum (Frequency-Domain) Measurement

Commands for querying the spectrum measurement results and for setting to the default values are found in the “[MEASure Group of Commands](#)” on page 519. The equivalent front-panel keys for the parameters described in the following commands, are found under the **Meas Setup** key, after the **Spectrum (Freq Domain)** measurement has been selected from the **MEASURE** key menu.

Spectrum—Data Acquisition Packing

```
[ :SENSE ] :SPECTrum:ACQuisition:PACKing  
AUTO | LONG | MEdium | SHORt
```

```
[ :SENSe ] :SPECTrum:ACQuisition:PACKing?
```

Select the amount of data acquisition packing. This is an advanced control that normally does not need to be changed.

Factory Preset: AUTO

Remarks: To use this command for E4406A, the appropriate mode should be selected with INSTRUMENT:SElect.

For PSA you must be in the Basic, Analog Modulation, cdmaOne, cdma2000, 1xEV-DO, W-CDMA, GSM, EDGE, NADC, or PDC mode to use this command. Use INSTRUMENT:SElect to set the mode.

Spectrum—ADC Dither Control

```
[ :SENSe] :SPECTrum:ADC:DITHer [:STATe] AUTO | ON | OFF | 2 | 1 | 0
```

```
[ :SENSe] :SPECTrum:ADC:DITHer [:STATe] ?
```

Turn the ADC dither on or off. This is an advanced control that normally does not need to be changed. The “ADC dither” refers to the introduction of noise to the digitized steps of the analog-to-digital converter; the result is an improvement in amplitude accuracy.

The Option 122 wideband ADC dither uses
SENSe:SPECTrum:WBIF:ADC:DITHer.

Factory Preset: AUTO

Remarks: To use this command for E4406A, the appropriate mode should be selected with INSTRument:SElect.

For PSA you must be in the Basic, Analog Modulation, cdmaOne, cdma2000, 1xEV-DO, W-CDMA, GSM, EDGE, NADC, or PDC mode to use this command. Use INSTRument:SElect to set the mode.

Spectrum—ADC Range

12-bit ADC E4406A

```
[ :SENSe] :SPECTrum:ADC:RANGe
```

```
AUTO | APEak | APLock | M6 | P0 | P6 | P12 | P18 | P24
```

PSA and 14-bit ADC E4406A

```
[ :SENSe] :SPECTrum:ADC:RANGe
```

```
AUTO | APEak | APLock | NONE | P0 | P6 | P12 | P18
```

```
[ :SENSe] :SPECTrum:ADC:RANGe?
```

Select the range for the gain-ranging that is done in front of the ADC. This is an advanced control that normally does not need to be changed. Auto peak ranging is the default for this measurement. If you are measuring a CW signal please see the description below.

- AUTO - automatic range

For FFT spectrums - auto ranging should not be used. An exception to this would be if you know that your signal is “bursty”. Then you might use auto to maximize the time domain dynamic range as long as you are not very interested in the FFT data.

- Auto Peak (APEak) - automatically peak the range

For CW signals, the default of auto-peak ranging can be used, but a better FFT measurement of the signal can be made by selecting one of the manual ranges that are available: M6, P0 - P24.

Auto peaking can cause the ADC range gain to move monotonically down during the data capture. This movement should have negligible effect on the FFT spectrum, but selecting a manual range removes this possibility. Note that if the CW signal being measured is close to the auto-ranging threshold, the noise floor may shift as much as 6 dB from sweep to sweep.

- Auto Peak Lock (APLock) - automatically peak lock the range

For CW signals, auto-peak lock ranging may be used. It will find the best ADC measurement range for this particular signal and will not move the range as auto-peak can. Note that if the CW signal being measured is close to the auto-ranging threshold, the noise floor may shift as much as 6 dB from sweep to sweep.

For “bursty” signals, auto-peak lock ranging should not be used. The measurement will fail to operate, since the wrong (locked) ADC range will be chosen often and overloads will occur in the ADC.

- NONE - (PSA and 14-bit ADC E4406A) turns off any auto-ranging without making any changes to the current setting.
- M6 - (12-bit ADC E4406A) manually selects an ADC range that subtracts 6 dB of fixed gain across the range. Manual ranging is best for CW signals.
- P0 to P18 - (PSA and 14-bit ADC E4406A) manually selects ADC ranges that add 0 to 18 dB of fixed gain across the range. Manual ranging is best for CW signals.
- P0 to 24 - (12-bit ADC E4406A) manually selects ADC ranges that add 0 to 24 dB of fixed gain across the range. Manual ranging is best for CW signals.

Factory Preset: APEak

Remarks: To use this command for E4406A, the appropriate mode should be selected with INSTRument:SElect.

For PSA you must be in the Basic, Analog Modulation, cdmaOne, cdma2000, 1xEV-DO, W-CDMA, GSM, EDGE, NADC, or PDC mode to use this command. Use INSTRument:SElect to set the mode.

Spectrum—Average Clear

`[:SENSE] :SPECTrum:AVERAge:CLEAr`

The average data is cleared and the average counter is reset.

Remarks: To use this command for E4406A, the appropriate mode should be selected with `INSTRument:SElect`.

For PSA you must be in the Basic, Analog Modulation, cdmaOne, cdma2000, 1xEV-DO, W-CDMA, GSM, EDGE, NADC, or PDC mode to use this command. Use `INSTRument:SElect` to set the mode.

Spectrum—Number of Averages

`[:SENSE] :SPECTrum:AVERAge:COUNT <integer>`

`[:SENSE] :SPECTrum:AVERAge:COUNT?`

Set the number of 'sweeps' that will be averaged. After the specified number of 'sweeps' (average counts), the averaging mode (terminal control) setting determines the averaging action.

Factory Preset: 25

Range: 1 to 10,000

Remarks: To use this command for E4406A, the appropriate mode should be selected with `INSTRument:SElect`.

For PSA you must be in the Basic, Analog Modulation, cdmaOne, cdma2000, 1xEV-DO, W-CDMA, GSM, EDGE, NADC, or PDC mode to use this command. Use `INSTRument:SElect` to set the mode.

Spectrum—Averaging State

```
[ :SENSe ] :SPECTrum:AVERAge [ :STATe ] OFF | ON | 0 | 1
```

```
[ :SENSe ] :SPECTrum:AVERAge [ :STATe ] ?
```

Turn averaging on or off.

Factory Preset: On

Remarks: To use this command for E4406A, the appropriate mode should be selected with INSTRUMENT:SELEct.

For PSA you must be in the Basic, Analog Modulation, cdmaOne, cdma2000, 1xEV-DO, W-CDMA, GSM, EDGE, NADC, or PDC mode to use this command. Use INSTRUMENT:SELEct to set the mode.

Spectrum—Averaging Termination Control

```
[ :SENSe ] :SPECTrum:AVERAge:TCONTRol EXPonential | REPeat
```

```
[ :SENSe ] :SPECTrum:AVERAge:TCONTRol ?
```

Select the type of termination control used for the averaging function. This determines the averaging action after the specified number of ‘sweeps’ (average count) is reached.

EXPonential - Each successive data acquisition after the average count is reached, is exponentially weighted and combined with the existing average.

REPeat - After reaching the average count, the averaging is reset and a new average is started.

Factory Preset: EXPonential

Remarks: To use this command for E4406A, the appropriate mode should be selected with INSTRUMENT:SELEct.

For PSA you must be in the Basic, Analog Modulation, cdmaOne, cdma2000, 1xEV-DO, W-CDMA, GSM, EDGE, NADC, or PDC mode to use this command. Use INSTRUMENT:SELEct to set the mode.

Spectrum—Averaging Type

```
[ :SENSe ] :SPECTrum:AVERAge:TYPE  
LOG | MAXimum | MINimum | RMS | SCALar
```

```
[ :SENSe ] :SPECTrum:AVERAge:TYPE ?
```

Select the type of averaging.

LOG – The log of the power is averaged. (This is also known as video averaging.)

MAXimum – The maximum values are retained.

MINimum – The minimum values are retained.

RMS – The power is averaged, providing the rms of the voltage.

SCALAR – The voltage is averaged.

Factory Preset: LOG

Remarks: To use this command for E4406A, the appropriate mode should be selected with INSTRUMENT:SElect.

For PSA you must be in the Basic, Analog Modulation, cdmaOne, cdma2000, 1xEV-DO, W-CDMA, GSM, EDGE, NADC, or PDC mode to use this command. Use INSTRUMENT:SElect to set the mode.

Spectrum—Select Pre-FFT Bandwidth

```
[ :SENSe ] :SPECTrum: BANDwidth | BWIDth: IF: AUTO OFF | ON | 0 | 1
```

```
[ :SENSe ] :SPECTrum: BANDwidth | BWIDth: IF: AUTO?
```

Select auto or manual control of the pre-FFT BW.

Factory Preset: Auto, 1.55 MHz

Auto, 10 MHz for wideband IF path
(SENSe:SPECTrum:IFPath WIDE)

Couplings/

Dependencies: PSA: If you have the wideband Option 122 and the wideband IF path is selected, then the sample rate = $1.25 \times$ IF bandwidth.

Remarks: To use this command for E4406A, the appropriate mode should be selected with INSTRUMENT:SElect.

For PSA you must be in the Basic, Analog Modulation, cdmaOne, cdma2000, 1xEV-DO, W-CDMA, GSM, EDGE, NADC, or PDC mode to use this command. Use INSTRUMENT:SElect to set the mode.

Key Path: **Measure, Spectrum, Meas Setup, More, Advanced, Pre-FFT BW.**

History: Modified in PSA revision A.06.00.

Spectrum—IF Flatness Corrections

```
[ :SENSe] :SPECTrum: BANDwidth | BWIDth: IF: FLATness OFF | ON | 0 | 1
```

```
[ :SENSe] :SPECTrum: BANDwidth | BWIDth: IF: FLATness?
```

Turns IF flatness corrections on and off for the pre-FFT narrowband IF. The Option 122 wideband IF flatness control uses SENSE:SPECTrum:WBIF:FLATness.

Factory Preset: ON

Remarks: To use this command for E4406A, the appropriate mode should be selected with INSTRUMENT:SELEct.

For PSA you must be in the Basic, Analog Modulation, cdmaOne, cdma2000, 1xEV-DO, W-CDMA, GSM, EDGE, NADC, or PDC mode to use this command. Use INSTRUMENT:SELEct to set the mode.

Key Path: **Measure, Spectrum, Meas Setup, More, Advanced, Pre-FFT BW**

Spectrum—Pre-ADC Bandpass Filter

```
[ :SENSe] :SPECTrum: BANDwidth | BWIDth: PADC OFF | ON | 0 | 1
```

```
[ :SENSe] :SPECTrum: BANDwidth | BWIDth: PADC?
```

Turn the pre-ADC bandpass filter on or off. This is an advanced control that normally does not need to be changed.

Remarks: To use this command for E4406A, the appropriate mode should be selected with INSTRUMENT:SELEct.

For PSA you must be in the Basic, Analog Modulation, cdmaOne, cdma2000, 1xEV-DO, W-CDMA, GSM, EDGE, NADC, or PDC mode to use this command. Use INSTRUMENT:SELEct to set the mode.

Spectrum—Pre-FFT BW

```
[ :SENSe ] :SPECTrum: BANDwidth | BWIDth: PFFT [ :SIZE ] <freq>
```

```
[ :SENSe ] :SPECTrum: BANDwidth | BWIDth: PFFT [ :SIZE ] ?
```

Set the pre-FFT bandwidth. This is an advanced control that normally does not need to be changed.

Frequency span, resolution bandwidth, and the pre-FFT bandwidth settings are normally coupled. If you are not auto-coupled, there can be combinations of these settings that are not valid.

Factory Preset: 1.55 MHz

1.25 MHz for cdmaOne

155.0 kHz, for iDEN mode (E4406A)

Range: 1 Hz to 10.0 MHz

Remarks: To use this command for E4406A, the appropriate mode should be selected with INSTRument:SElect.

For PSA you must be in the Basic, Analog Modulation, cdmaOne, cdma2000, 1xEV-DO, W-CDMA, GSM, EDGE, NADC, or PDC mode to use this command. Use INSTRument:SElect to set the mode.

Spectrum—Pre-FFT BW Filter Type

```
[ :SENSe ] :SPECTrum: BANDwidth | BWIDth: PFFT: TYPE FLAT | GAUSSian
```

```
[ :SENSe ] :SPECTrum: BANDwidth | BWIDth: PFFT: TYPE ?
```

Select the type of pre-FFT filter that is used. This is an advanced control that normally does not need to be changed.

Flat top (FLAT)- a filter with a flat amplitude response, which provides the best amplitude accuracy.

GAUSSian - a filter with Gaussian characteristics, which provides the best pulse response.

Factory Preset: FLAT

Couplings and

Dependencies: From the front panel this functionality is not available (key is greyed out), but this command will change the setting.

Remarks: To use this command for E4406A, the appropriate mode should be selected with INSTRUMENT:SELEct.

For PSA you must be in the Basic, Analog Modulation, cdmaOne, cdma2000, 1xEV-DO, W-CDMA, GSM, EDGE, NADC, or PDC mode to use this command. Use INSTRUMENT:SELEct to set the mode.

History: PSA: modified with revision A.06.00

Spectrum—Resolution BW

```
[ :SENSe ] :SPECTrum: BANDwidth | BWIDth [ :RESolution ] <freq>
```

```
[ :SENSe ] :SPECTrum: BANDwidth | BWIDth [ :RESolution ] ?
```

Set the resolution bandwidth for the FFT. This is the bandwidth used for resolving the FFT measurement. It is not the pre-FFT bandwidth. This value is ignored if the function is auto-coupled.

Frequency span, resolution bandwidth, and the pre-FFT bandwidth settings are normally coupled. If you are not auto-coupled, there can be combinations of these settings that are not valid.

Factory Preset: 20.0 kHz

250.0 Hz, for iDEN mode (E4406A)

Range: 0.10 Hz to 3.0 MHz

Remarks: To use this command for E4406A, the appropriate mode should be selected with INSTRUMENT:SElect.

For PSA you must be in the Basic, Analog Modulation, cdmaOne, cdma2000, 1xEV-DO, W-CDMA, GSM, EDGE, NADC, or PDC mode to use this command. Use INSTRUMENT:SElect to set the mode.

Spectrum—Resolution BW Auto

```
[ :SENSe ] :SPECTrum: BANDwidth | BWIDth [ :RESolution ] :AUTO  
OFF | ON | 0 | 1
```

```
[ :SENSe ] :SPECTrum: BANDwidth | BWIDth [ :RESolution ] :AUTO?
```

Select auto or manual control of the resolution BW. The automatic mode couples the resolution bandwidth setting to the frequency span.

Factory Preset: ON

OFF, for iDEN mode (E4406A)

Remarks: To use this command for E4406A, the appropriate mode should be selected with INSTRUMENT:SElect.

For PSA you must be in the Basic, Analog Modulation, cdmaOne, cdma2000, W-CDMA, GSM, EDGE, NADC, or PDC mode to use this command. Use INSTRUMENT:SElect to set the mode.

Spectrum—Decimation of Spectrum Display

```
[ :SENSe ] :SPECTrum:DECimate [ :FACTor ] <integer>
```

```
[ :SENSe ] :SPECTrum:DECimate [ :FACTor ] ?
```

Sets the amount of data decimation done by the hardware and/or the software. Decimation by *n* keeps every *n*th sample, throwing away each of the remaining samples in the group of *n*. For example, decimation by 3 keeps every third sample, throwing away the two in between. Similarly, decimation by 5 keeps every fifth sample, throwing away the four in between.

Using zero (0) decimation selects the automatic mode. The measurement will then automatically choose decimation by “1” or “2” as is appropriate for the bandwidth being used.

This is an advanced control that normally does not need to be changed.

Factory Preset: 0

Range: 0 to 1,000, where 0 sets the function to automatic

Remarks: To use this command for E4406A, the appropriate mode should be selected with INSTRUMENT:SElect.

For PSA you must be in the Basic, Analog Modulation, cdmaOne, cdma2000, 1xEV-DO, W-CDMA, GSM, EDGE, NADC, or PDC mode to use this command. Use INSTRUMENT:SElect to set the mode.

History: E4406A:
Version A.02.00 or later

Spectrum—FFT Length

```
[ :SENSe ] :SPECTrum:FFT:LENGth <integer>
```

```
[ :SENSe ] :SPECTrum:FFT:LENGth?
```

Set the FFT length. This value is only used if length control is set to manual. The value must be greater than or equal to the window length value. Any amount greater than the window length is implemented by zero-padding. This is an advanced control that normally does not need to be changed.

Factory Preset: 706

Range: min, depends on the current setting of the spectrum window length
max, 1,048,576

Remarks: To use this command for E4406A, the appropriate mode should be selected with INSTRUMENT:SELEct.

For PSA you must be in the Basic, Analog Modulation, cdmaOne, cdma2000, 1xEV-DO, W-CDMA, GSM, EDGE, NADC, or PDC mode to use this command. Use INSTRUMENT:SELEct to set the mode.

History: E4406A:
Short form changed from LENgth to LENGth, A.03.00

Spectrum—FFT Length Auto

```
[ :SENSe ] :SPECTrum:FFT:LENGth:AUTO OFF | ON | 0 | 1
```

```
[ :SENSe ] :SPECTrum:FFT:LENGth:AUTO?
```

Select auto or manual control of the FFT and window lengths.

This is an advanced control that normally does not need to be changed.

On - the window lengths are coupled to resolution bandwidth, window type (FFT), pre-FFT bandwidth (sample rate) and SENSE:SPECTrum:FFT:RBWPoints.

Off - lets you set SENSE:SPECTrum:FFT:LENGth and SENSE:SPECTrum:FFT:WINDow:LENGth.

Factory Preset: ON

Remarks: To use this command for E4406A, the appropriate mode should be selected with INSTRUMENT:SELEct.

For PSA you must be in the Basic, Analog Modulation, cdmaOne, cdma2000, 1xEV-DO, W-CDMA, GSM, EDGE, NADC, or PDC mode to use this command. Use INSTRUMENT:SELEct to set the mode.

History: E4406A:
Short form changed from LENgth to LENGth, A.03.00

Spectrum—FFT Minimum Points in Resolution BW

`[[:SENSe]:SPECTrum:FFT:RBWPoints <real>`

`[[:SENSe]:SPECTrum:FFT:RBWPoints?`

Set the minimum number of data points that will be used inside the resolution bandwidth. The value is ignored if length control is set to manual. This is an advanced control that normally does not need to be changed.

Factory Preset: 1.30

Range: 0.1 to 100

Remarks: To use this command for E4406A, the appropriate mode should be selected with `INSTRument:SElect`.

For PSA you must be in the Basic, Analog Modulation, cdmaOne, cdma2000, 1xEV-DO, W-CDMA, GSM, EDGE, NADC, or PDC mode to use this command. Use `INSTRument:SElect` to set the mode.

Spectrum—Window Delay

`[[:SENSe]:SPECTrum:FFT:WINDow:DElay <real>`

`[[:SENSe]:SPECTrum:FFT:WINDow:DElay?`

Set the FFT window delay to move the FFT window from its nominal position of being centered within the time capture. This function is not available from the front panel. It is an advanced control that normally does not need to be changed.

Factory Preset: 0

Range: -10.0 to +10.0s

Default Unit: seconds

Remarks: To use this command for E4406A, the appropriate mode should be selected with `INSTRument:SElect`.

For PSA you must be in the Basic, Analog Modulation, cdmaOne, cdma2000, 1xEV-DO, W-CDMA, GSM, EDGE, NADC, or PDC mode to use this command. Use `INSTRument:SElect` to set the mode.

Spectrum—Window Length

`[:SENSE] :SPECTrum:FFT:WINDow:LENGth <integer>`

`[:SENSe] :SPECTrum:FFT:WINDow:LENGth?`

Set the FFT window length. This value is only used if length control is set to manual. This is an advanced control that normally does not need to be changed.

Factory Preset: 706

Range: 8 to 1,048,576

Remarks: To use this command for E4406A, the appropriate mode should be selected with `INSTRument:SElect`.

For PSA you must be in the Basic, Analog Modulation, cdmaOne, cdma2000, 1xEV-DO, W-CDMA, GSM, EDGE, NADC, or PDC mode to use this command. Use `INSTRument:SElect` to set the mode.

History: E4406A:
Short form changed from `LENGth` to `LENGth`, A.03.00

Spectrum—FFT Window

`[:SENSE] :SPECTrum:FFT:WINDow [:TYPE]`

`BH4Tap | BLACkman | FLATtop | GAUSSian |
HAMMing | HANNing | KB70 | KB90 | KB110 | UNIFORM`

`[:SENSE] :SPECTrum:FFT:WINDow [:TYPE] ?`

Select the FFT window type.

BH4Tap - Blackman Harris with 4 taps

BLACkman - Blackman

FLATtop - flat top, the default (for high amplitude accuracy)

GAUSSian - Gaussian with alpha of 3.5

HAMMing - Hamming

HANNing - Hanning

KB70, 90, and 110 - Kaiser Bessel with sidelobes at -70, -90, or -110 dBc

UNIFORM - no window is used. (This is the unity response.)

Factory Preset: FLATtop

Remarks: This selection affects the acquisition point quantity and the FFT size, based on the resolution bandwidth selected.

To use this command for E4406A, the appropriate mode should be selected with INSTRUMENT:SElect.

For PSA you must be in the Basic, Analog Modulation, cdmaOne, cdma2000, 1xEV-DO, W-CDMA, GSM, EDGE, NADC, or PDC mode to use this command. Use INSTRUMENT:SElect to set the mode.

Spectrum—Frequency Span

```
[ :SENSe ] :SPECTrum:FREQuency:SPAN <freq>
```

```
[ :SENSe ] :SPECTrum:FREQuency:SPAN?
```

Set the frequency span to be measured.

Factory Preset: 1.0 MHz

100.0 kHz for iDEN mode (E4406A)

Range: 10 Hz to 10.0 MHz (15 MHz when Service mode is selected)

Default Unit: Hz

Remarks: The actual measured span will generally be slightly wider due to the finite resolution of the FFT.

To use this command for E4406A, the appropriate mode should be selected with INSTRUMENT:SElect.

For PSA you must be in the Basic, Analog Modulation, cdmaOne, cdma2000, 1xEV-DO, W-CDMA, GSM, EDGE, NADC, or PDC mode to use this command. Use INSTRUMENT:SElect to set the mode.

Spectrum—Sweep (Acquisition) Time

`[[:SENSE]:SPECTrum:SWEep:TIME[:VALue] <time>`

`[[:SENSe]:SPECTrum:SWEep:TIME?`

Set the sweep (measurement acquisition) time. It is used to specify the length of the time capture record. If the value you specify is less than the capture time required for the specified span and resolution bandwidth, the value is ignored. The value is set at its auto value when auto is selected. This is an advanced control that normally does not need to be changed.

Factory Preset: 18.83 μ s

15.059 ms, for iDEN mode (E4406A)

Range: 100 ns to 10 s

Default Unit: seconds

Remarks: To use this command for E4406A, the appropriate mode should be selected with `INSTRument:SElect`.

For PSA you must be in the Basic, Analog Modulation, cdmaOne, cdma2000, 1xEV-DO, W-CDMA, GSM, EDGE, NADC, or PDC mode to use this command. Use `INSTRument:SElect` to set the mode.

Spectrum—Sweep (Acquisition) Time Auto

`[[:SENSE]:SPECTrum:SWEep:TIME:AUTO OFF|ON|0|1`

`[[:SENSe]:SPECTrum:SWEep:TIME:AUTO`

Select auto or manual control of the sweep (acquisition) time. This is an advanced control that normally does not need to be changed.

AUTO - couples the Sweep Time to the Frequency Span and Resolution BW

Manual - the Sweep Time is uncoupled from the Frequency Span and Resolution BW.

Factory Preset: AUTO

Remarks: To use this command for E4406A, the appropriate mode should be selected with `INSTRument:SElect`.

For PSA you must be in the Basic, Analog Modulation, cdmaOne, cdma2000, 1xEV-DO, W-CDMA, GSM, EDGE, NADC, or PDC mode to use this command. Use `INSTRument:SElect` to set the mode.

Spectrum—Trigger Source

```
[ :SENSe ] :SPECTrum:TRIGger:SOURce  
EXTernal [1] | EXTernal2 | FRAMe | IF | LINE |  
IMMEDIATE | RFBurst
```

```
[ :SENSe ] :SPECTrum:TRIGger:SOURce?
```

Select the trigger source used to control the data acquisitions.

EXTernal1 - front-panel external trigger input

EXTernal2 - rear-panel external trigger input

FRAMe - internal frame timer from front-panel input

IF - internal IF envelope (video) trigger

LINE - internal line trigger

IMMEDIATE - the next data acquisition is immediately taken (also called free run)

RFBurst - wideband RF burst envelope trigger that has automatic level control for periodic burst signals

Factory Preset: IMMEDIATE (free run)

RFBurst, for GSM, iDEN mode

Remarks: To use this command for E4406A, the appropriate mode should be selected with INSTRUMENT:SELECT.

For PSA you must be in the Basic, Analog Modulation, cdmaOne, cdma2000, 1xEV-DO, W-CDMA, GSM, EDGE, NADC, or PDC mode to use this command. Use INSTRUMENT:SELECT to set the mode.

Waveform (Time-Domain) Measurement

Commands for querying the waveform measurement results and for setting to the default values are found in the “[MEASure Group of Commands](#)” on page 519. The equivalent front-panel keys for the parameters described in the following commands, are found under the **Meas Setup** key, after the **Waveform (Time Domain)** measurement has been selected from the **MEASURE** key menu.

Waveform—Data Acquisition Packing

```
[ :SENSe ] :WAVeform:ACQuisition:PACKing  
AUTO | LONG | MEDium | SHORt
```

```
[ :SENSe ] :WAVeform:ACQuisition:PACKing?
```

This is an advanced control that normally does not need to be changed.

Factory Preset: AUTO

Remarks: To use this command for E4406A, the appropriate mode should be selected with `INSTRument:SElect`.

For PSA you must be in the Basic, Analog Modulation, cdmaOne, cdma2000, 1xEV-DO, W-CDMA, GSM, EDGE, NADC, or PDC mode to use this command. Use `INSTRument:SElect` to set the mode.

Waveform—ADC Dither Control

```
[ :SENSe] :WAVeform:ADC:DITHer [:STATe] AUTO|ON|OFF|2|1|0
```

```
[ :SENSe] :WAVeform:ADC:DITHer [:STATe] ?
```

Turn the ADC dither on or off. This is an advanced control that normally does not need to be changed. The “ADC dither” refers to the introduction of noise to the digitized steps of the analog-to-digital converter; the result is an improvement in amplitude accuracy.

The Option 122 wideband ADC dither uses
SENSe:WAVeform:WBIF:ADC:DITHer.

Factory Preset: AUTO

Remarks: To use this command for E4406A, the appropriate mode should be selected with INSTRument:SElect.

For PSA you must be in the Basic, Analog Modulation, cdmaOne, cdma2000, 1xEV-DO, W-CDMA, GSM, EDGE, NADC, or PDC mode to use this command. Use INSTRument:SElect to set the mode.

Waveform—Pre-ADC Bandpass Filter

```
[ :SENSe] :WAVeform:ADC:FILTer [:STATe] OFF|ON|0|1
```

```
[ :SENSe] :WAVeform:ADC:FILTer [:STATe] ?
```

Turn the pre-ADC bandpass filter on or off. This is an Advanced control that normally does not need to be changed.

Preset: OFF

Remarks: To use this command for E4406A, the appropriate mode should be selected with INSTRument:SElect.

For PSA you must be in the Basic, Analog Modulation, cdmaOne, cdma2000, 1xEV-DO, W-CDMA, GSM, EDGE, NADC, or PDC mode to use this command. Use INSTRument:SElect to set the mode.

Waveform—ADC Range

12-bit ADC E4406A

`[:SENSe] :WAVeform:ADC:RANGe`

`AUTO | APEak | APLock | GROund | M6 | P0 | P6 | P12 | P18
| P24`

PSA and 14-bit ADC E4406A

`[:SENSe] :WAVeform:ADC:RANGe`

`AUTO | APEak | APLock | GROund | NONE | P0 | P6 | P12 | P18`

`[:SENSe] :WAVeform:ADC:RANGe?`

Select the range for the gain-ranging that is done in front of the ADC. This is an Advanced control that normally does not need to be changed.

AUTO - automatic range

Auto Peak (APEak) - automatically peak the range

Auto Peak Lock (APLock)- automatically peak lock the range

GROund - ground

NONE - (PSA and 14-bit ADC E4406A) turn off auto-ranging without making any changes to the current setting.

M6 - (12-bit ADC E4406A) subtracts 6 dB of fixed gain across the range

P0 to P18 - (PSA and 14-bit ADC E4406A) adds 0 to 18 dB of fixed gain across the range

P0 to P24 - (12-bit ADC E4406A) adds 0 to 24 dB of fixed gain across the range

Factory Preset: AUTO

Remarks: To use this command for E4406A, the appropriate mode should be selected with `INSTRument:SElect`.

For PSA you must be in the Basic, Analog Modulation, cdmaOne, cdma2000, 1xEV-DO, W-CDMA, GSM, EDGE, NADC, or PDC mode to use this command. Use `INSTRument:SElect` to set the mode.

Waveform—Sample Period (Aperture) Setting

`[:SENSe] :WAVeform:APERTure?`

Returns the time between samples (sample period or aperture). This value is based on current resolution bandwidth, filter type, and decimation factor. Sample rate is the reciprocal of the period.

Remarks: To use this command for E4406A, the appropriate mode should be selected with `INSTRument:SElect`.

For PSA you must be in the Basic, Analog Modulation, cdmaOne, cdma2000, 1xEV-DO, W-CDMA, GSM, EDGE, NADC, or PDC mode to use this command. Use `INSTRument:SElect` to set the mode.

History: PSA added revision A.04.00.

Waveform—Number of Averages

`[:SENSe] :WAVeform:AVERage:COUNT <integer>`

`[:SENSe] :WAVeform:AVERage:COUNT?`

Set the number of sweeps that will be averaged. After the specified number of sweeps (average counts), the averaging mode (terminal control) setting determines the averaging action.

Factory Preset: 10

Range: 1 to 10,000

Remarks: To use this command for E4406A, the appropriate mode should be selected with `INSTRument:SElect`.

For PSA you must be in the Basic, Analog Modulation, cdmaOne, cdma2000, 1xEV-DO, W-CDMA, GSM, EDGE, NADC, or PDC mode to use this command. Use `INSTRument:SElect` to set the mode.

Waveform—Averaging State

`[:SENSE] :WAVEform:AVERage [:STATe] OFF | ON | 0 | 1`

`[:SENSE] :WAVEform:AVERage [:STATe] ?`

Turn averaging on or off.

Factory Preset: OFF

Remarks: To use this command for E4406A, the appropriate mode should be selected with `INSTRument:SElect`.

For PSA you must be in the Basic, Analog Modulation, cdmaOne, cdma2000, 1xEV-DO, W-CDMA, GSM, EDGE, NADC, or PDC mode to use this command. Use `INSTRument:SElect` to set the mode.

Waveform—Averaging Termination Control

`[:SENSE] :WAVEform:AVERage:TCONtrol EXPonential | REPEAT`

`[:SENSE] :WAVEform:AVERage:TCONtrol ?`

Select the type of termination control used for the averaging function. This determines the averaging action after the specified number of ‘sweeps’ (average count) is reached.

EXPonential - After the average count has been reached, each successive data acquisition is exponentially weighted and combined with the existing average.

REPEAT - After reaching the average count, the averaging is reset and a new average is started.

Factory Preset: EXPonential

Remarks: To use this command for E4406A, the appropriate mode should be selected with `INSTRument:SElect`.

For PSA you must be in the Basic, Analog Modulation, cdmaOne, cdma2000, 1xEV-DO, W-CDMA, GSM, EDGE, NADC, or PDC mode to use this command. Use `INSTRument:SElect` to set the mode.

Waveform—Averaging Type

```
[ :SENSe] :WAVeform:AVERAge:TYPE
LOG | MAXimum | MINimum | RMS | SCALar
```

```
[ :SENSe] :WAVeform:AVERAge:TYPE?
```

Select the type of averaging.

LOG - The log of the power is averaged. (This is also known as video averaging.)

MAXimum - The maximum values are retained.

MINimum - The minimum values are retained.

RMS - The power is averaged, providing the rms of the voltage.

Factory Preset: RMS

Remarks: To use this command for E4406A, the appropriate mode should be selected with INSTRUMENT:SElect.

For PSA you must be in the Basic, Analog Modulation, cdmaOne, cdma2000, 1xEV-DO, W-CDMA, GSM, EDGE, NADC, or PDC mode to use this command. Use INSTRUMENT:SElect to set the mode.

Waveform—Resolution BW

```
[ :SENSe] :WAVeform:BANDwidth|BWIDth[:RESolution] <freq>
```

```
[ :SENSe] :WAVeform:BANDwidth|BWIDth[:RESolution]?
```

Set the resolution bandwidth. This value is ignored if the function is auto-coupled.

Factory Preset: 20.0 kHz for NADC, PDC, cdma2000, W-CDMA, Basic, Service (E4406A)
500.0 kHz for GSM
2.0 MHz for cdmaOne

Range: 1.0 kHz to 8.0 MHz when
SENSe:WAV:BWID:RES:TYPE GAUSSian

100 mHz to 10.0 MHz when
SENSe:WAV:BWID:RES:TYPE FLATtop

PSA: 10.0 Hz to 10 MHz, for Basic Mode

PSA Option 122: 10 kHz to 80 MHz, for Basic Mode

Remarks: To use this command for E4406A, the appropriate mode should be selected with INSTRUMENT:SELEct.

For PSA you must be in the Basic, Analog Modulation, cdmaOne, cdma2000, 1xEV-DO, W-CDMA, GSM, EDGE, NADC, or PDC mode to use this command. Use INSTRUMENT:SELEct to set the mode.

Bandwidths > 6.7 MHz will require a slight increase in measurement time.

History: PSA modified in revision A.06.00.

Waveform—Query Actual Resolution Bandwidth

`[:SENSE] :WAVEform :BANDwidth [:RESolution] :ACTual?`

Due to memory constraints the actual resolution bandwidth value may vary from the value entered by the user. For most applications the resulting difference in value is inconsequential but for some it is necessary to know the actual value; this query retrieves the actual resolution bandwidth value.

Remarks: To use this command for E4406A, the appropriate mode should be selected with INSTRUMENT:SELEct.

For PSA you must be in the Basic, Analog Modulation, cdmaOne, cdma2000, 1xEV-DO, W-CDMA, GSM, EDGE, NADC, or PDC mode to use this command. Use INSTRUMENT:SELEct to set the mode.

History: E4406A: added in version A.05.00 or later

Waveform—Resolution BW Filter Type

```
[ :SENSe ] :WAVeform: BANDwidth | BWIDth [ :RESolution ] :TYPE  
FLATtop | GAUSSian
```

```
[ :SENSe ] :WAVeform: BANDwidth | BWIDth [ :RESolution ] :TYPE?
```

Select the type of Resolution BW filter that is used. This is an Advanced control that normally does not need to be changed.

FLATtop - a filter with a flat amplitude response, which provides the best amplitude accuracy.

GAUSSian - a filter with Gaussian characteristics, which provides the best pulse response.

Factory Preset: GAUSSian

Remarks: To use this command for E4406A, the appropriate mode should be selected with INSTRUMENT:SELECT.

For PSA you must be in the Basic, Analog Modulation, cdmaOne, cdma2000, 1xEV-DO, W-CDMA, GSM, EDGE, NADC, or PDC mode to use this command. Use INSTRUMENT:SELECT to set the mode.

Waveform—Decimation of Waveform Display

```
[ :SENSe ] :WAVeform: DECimate [ :FACTor ] <integer>
```

```
[ :SENSe ] :WAVeform: DECimate [ :FACTor ] ?
```

Set the amount of data decimation done on the IQ data stream. For example, if 4 is selected, three out of every four data points will be thrown away. So every 4th data point will be kept.

Factory Preset: 1

Range: 1 to 4

Remarks: To use this command for E4406A, the appropriate mode should be selected with INSTRUMENT:SELECT.

For PSA you must be in the Basic, Analog Modulation, cdmaOne, cdma2000, 1xEV-DO, W-CDMA, GSM, EDGE, NADC, or PDC mode to use this command. Use INSTRUMENT:SELECT to set the mode.

Waveform—Control Decimation of Waveform Display

```
[ :SENSe ] :WAVeform:DECimate:STATe OFF|ON|0|1
```

```
[ :SENSe ] :WAVeform:DECimate:STATe?
```

Set the amount of data decimation done by the hardware in order to decrease the number of acquired points in a long capture time. This is the amount of data that the measurement ignores.

Factory Preset: OFF

Remarks: To use this command for E4406A, the appropriate mode should be selected with INSTRUMENT:SElect.

For PSA you must be in the Basic, Analog Modulation, cdmaOne, cdma2000, 1xEV-DO, W-CDMA, GSM, EDGE, NADC, or PDC mode to use this command. Use INSTRUMENT:SElect to set the mode.

Waveform—Sweep (Acquisition) Time

```
[ :SENSe ] :WAVeform:SWEep:TIME <time>
```

```
[ :SENSe ] :WAVeform:SWEep:TIME?
```

Set the measurement acquisition time. It is used to specify the length of the time capture record.

Factory Preset: 2.0 ms

100.0 ms, for Basic Mode (PSA)

10.0 ms, for NADC, PDC

15.0 ms, for iDEN mode (E4406A)

Range: 100 ns to 100 s

Default Unit: seconds

Remarks: To use this command for E4406A, the appropriate mode should be selected with INSTRUMENT:SElect.

For PSA you must be in the Basic, Analog Modulation, cdmaOne, cdma2000, 1xEV-DO, W-CDMA, GSM, EDGE, NADC, or PDC mode to use this command. Use INSTRUMENT:SElect to set the mode.

Waveform—Trigger Source

```
[ :SENSe ] :WAVeform:TRIGger:SOURce EXTeRnal [1] |  
EXTeRnal2 | FRAMe | IF | IMMEdiate | LINE | RFBurst
```

```
[ :SENSe ] :WAVeform:TRIGger:SOURce?
```

Select the trigger source used to control the data acquisitions.

EXTeRnal 1 - front-panel external trigger input

EXTeRnal 2 - rear-panel external trigger input

FRAMe - internal frame timer from front-panel input

IF - internal IF envelope (video) trigger

IMMEdiate - the next data acquisition is immediately taken (also called free run)

LINE - internal line trigger

RFBurst - wideband RF burst envelope trigger that has automatic level control for periodic burst signals (not available when using Option 122)

Factory Preset: IMMEdiate (free run), for Basic, cdmaOne, NADC, PDC mode

RFBurst, for GSM, iDEN (E4406A) modes

Remarks: To use this command for E4406A, the appropriate mode should be selected with INSTRument:SElect.

For PSA you must be in the Basic, Analog Modulation, cdmaOne, cdma2000, 1xEV-DO, W-CDMA, GSM, EDGE, NADC, or PDC mode to use this command. Use INSTRument:SElect to set the mode.

TRIGger Subsystem

The Trigger Subsystem is used to set the controls and parameters associated with triggering the data acquisitions. Other trigger-related commands are found in the INITiate and ABORt subsystems.

The trigger parameters are global within a selected Mode. The commands in the TRIGger subsystem set up the way the triggers function, but selection of the trigger source is made from each measurement. There is a separate trigger source command in the SENSE:<meas> subsystem for each measurement. The equivalent front-panel keys for the parameters described in the following commands, can be found under the **Mode Setup, Trigger** key.

Automatic Trigger Control

```
:TRIGger[:SEquence]:AUTO:STATe OFF|ON|0|1
```

```
:TRIGger[:SEquence]:AUTO:STATe?
```

Turns the automatic trigger function on and off. This function causes a trigger to occur if the designated time has elapsed and no trigger occurred. It can be used with unpredictable trigger sources, like external or burst, to make sure a measurement is initiated even if a trigger doesn't occur. Use TRIGger[:SEquence]:AUTO[:TIME] to set the time limit.

Factory Preset
and *RST Off for cdma2000, W-CDMA, NADC, PDC, 1xEV-DO

Key Path:
Access **Mode Setup, Trigger, Auto Trig**

Automatic Trigger Time

:TRIGger[:SEQuence]:AUTO[:TIME] <time>

:TRIGger[:SEQuence]:AUTO[:TIME]?

After the measurement is activated the instrument will take a data acquisition immediately upon receiving a signal from the selected trigger source. If no trigger signal is received by the end of the time specified in this command, a data acquisition is taken anyway. TRIGger[:SEQuence]:AUTO:STATE must be on.

Factory Preset: 100.0 ms

Range: 1.0 ms to 1000.0 s
 0.0 to 1000.0 s for cdma2000, W-CDMA, 1xEV-DO

Default Unit: seconds

Key Path:

Access **Mode Setup, Trigger, Auto Trig**

External Trigger Delay

:TRIGger[:SEQuence]:EXTernal[1]|2:DELAy <time>

:TRIGger[:SEQuence]:EXTernal[1]|2:DELAy?

Set the trigger delay when using an external trigger. Set the trigger value to zero (0) seconds to turn off the delay.

EXT or EXT1 is the front-panel trigger input.

EXT2 is the rear-panel trigger input.

Factory Preset: 0.0 s

Range: -100.0 ms to 500.0 ms

Default Unit: seconds

Key Path: **Mode Setup, Trigger, Ext Rear (or Ext Front), Delay**

External Trigger Level

```
:TRIGger[:SEQuence]:EXTErnal[1]|2:LEVel <voltage>
```

```
:TRIGger[:SEQuence]:EXTErnal[1]|2:LEVel?
```

Set the trigger level when using an external trigger input.

EXT or EXT1 is the front-panel trigger input

EXT2 is the rear-panel trigger input

Factory Preset: 2.0 V

Range: -5.0 to +5.0 V

Default Unit: volts

Key Path: **Mode Setup, Trigger, Ext Rear (or Ext Front), Level**

External Trigger Slope

```
:TRIGger[:SEQuence]:EXTErnal[1]|2:SLOPe NEGative|POSitive
```

```
:TRIGger[:SEQuence]:EXTErnal[1]|2:SLOPe?
```

Sets the trigger slope of an external trigger input to either NEGative or POSitive.

EXT or EXT1 is the front-panel trigger input.

EXT2 is the rear-panel trigger input.

Factory Preset: Positive

Key Path **Mode Setup, Trigger, Ext Rear (or Ext Front), Slope**

Frame Trigger Adjust

```
:TRIGger[:SEQuence]:FRAME:ADJust <time>
```

Lets you advance the phase of the frame trigger by the specified amount. It does not change the period of the trigger waveform. If the command is sent multiple times, it advances the phase of the frame trigger more each time it is sent.

Factory Preset: 0.0 s

Range: 0.0 to 10.0 s

Default Unit: seconds

Key Path: None

Frame Trigger Period

:TRIGger[:SEquence]:FRAMe:PERiod <time>

:TRIGger[:SEquence]:FRAMe:PERiod?

Set the frame period that you want when using the external frame timer trigger. If the traffic rate is changed, the value of the frame period is initialized to the preset value.

Factory Preset: 250.0 μ s for Basic, cdmaOne

4.615383 ms, for GSM

26.666667 ms for cdma2000 and 1xEV-DO

10.0 ms (1 radio frame) for W-CDMA

90.0 ms for iDEN (E4406A)

20.0 ms with rate=full for NADC, PDC

40.0 ms with rate=half for NADC, PDC

Range: 0.0 ms to 559.0 ms for Basic, cdmaOne, GSM, cdma2000, W-CDMA, 1xEV-DO

1.0 ms to 559.0 ms for iDEN (E4406A), NADC, PDC

Default Unit: seconds

Key Path: **Mode Setup, Trigger, Frame Timer, Period**

Trigger Holdoff

`:TRIGger[:SEQuence]:HOLDoff <time>`

`:TRIGger[:SEQuence]:HOLDoff?`

Set a value of the holdoff time between triggers. After a trigger, another trigger will not be allowed until the holdoff time expires. This parameter affects all trigger sources.

Factory Preset: 0.0 s

20.0 ms for iDEN (E4406A)

10.0 ms for NADC or PDC

Range: 0.0 to 500.0 ms

Default Unit: seconds

Key Path: **Mode Setup, Trigger, Trigger Holdoff**

Video (IF) Trigger Delay

`:TRIGger[:SEQuence]:IF:DELAy <time>`

`:TRIGger[:SEQuence]:IF:DELAy?`

Set a value of the trigger delay of the IF (video) trigger (signal after the resolution BW filter).

Factory Preset: 0.0 s

Range: -100.0 ms to 500.0 ms

Default Unit: seconds

Key Path: **Mode Setup, Trigger, Video (IF Envlp), Delay**

Video (IF) Trigger Level

:TRIGger[:SEquence]:IF:LEVel <amp1>

:TRIGger[:SEquence]:IF:LEVel?

Set the trigger level when using the IF (video) trigger.

Factory Preset: -6.0 dBm for cdmaOne, GSM, EDGE, Basic, Service (E4406A), cdma2000, W-CDMA, 1xEV-DO

-20.0 dBm for iDEN (E4406A)

-30.0 dBm for NADC, PDC

Range: -200.0 to 50.0 dBm

Default Unit: dBm

Key Path: **Mode Setup, Trigger, Video (IF Envlp), Level**

Video (IF) Trigger Slope

:TRIGger[:SEquence]:IF:SLOPe NEGative|POSitive

:TRIGger[:SEquence]:IF:SLOPe?

Sets the trigger slope when using the IF (video) trigger, to either NEGative or POSitive.

Factory Preset: Positive

Key Path: **Mode Setup, Trigger, Video (IF Envlp), Slope**

RF Burst Trigger Delay

:TRIGger[:SEquence]:RFBurst:DELaY <time>

:TRIGger[:SEquence]:RFBurst:DELaY?

Set the trigger delay when using the RF burst (wideband) trigger.

Factory Preset: 0.0 μ s

Range: -100.0 ms to 500.0 ms

Default Unit: seconds

Key Path: **Mode Setup, Trigger, RF Burst, Delay**

RF Burst Trigger Level

```
:TRIGger[:SEquence]:RFBurst:LEVel <rel_power>
```

```
:TRIGger[:SEquence]:RFBurst:LEVel?
```

Set the trigger level when using the RF Burst (wideband) Trigger. The value is relative to the peak of the signal. RF Burst is also known as RF Envelope.

Factory Preset: -6.0 dB

Range: -25.0 to 0.0 dB
-200.0 to 0.0 dB for NADC, PDC

Default Unit: dB

Key Path: **Mode Setup, Trigger, RF Burst, Peak Level**

RF Burst Trigger Slope

```
:TRIGger[:SEquence]:RFBurst:SLOPe NEGative|POSitive
```

```
:TRIGger[:SEquence]:RFBurst:SLOPe?
```

Set the trigger slope when using the RF Burst (wideband) Trigger.

Factory Preset: Positive

Remarks: You must be in the cdmaOne, cdma2000, W-CDMA mode to use this command. Use :INSTRument:SElect to set the mode.

Key Path: **Mode Setup, Trigger, RF Burst, Slope**

Numerics

- 1 Mohm balanced, 198, 207
- 1 Mohm unbalanced, 198, 207
- 1xEV-DO measurement, 979
- 2nd Carrier Offset key
 - Meas Setup key, 105
- 3rd generation RF cellular
 - W-CDMA, 396
- 3rd IM Only key
 - Meas Mode key, 106
- 50 MHz reference adjustment, 666
- 50 ohm unbalanced, 198, 207
- 600 ohm balanced, 198, 207

A**ACP**

- offset frequencies, 767
- offset sideband choice, 995
- setting amplitude levels, 764
- testing, 780, 995
- view of data, 620

ACPR

- amplitude levels, 774, 777
- changing display, 228
- channel integration bandwidth, 211
- detector type, 783
- FFT sweep, 784
- measurement reference type, 217
- offset frequencies, 770
- offsets & limits, 212
- resolution bandwidths, 767
- spectrum graph
 - amplitude Y scale, 228
 - display, 228
- sweep mode detection, 783
- sweep time, 783
- sweep type, 784
- swept mode res BW, 782
- testing choices, 779, 785, 995
- view/trace selection, 222

acpr

- sweep resolution bandwidth, 218
- sweep type
 - FFT, 218

ACPR (ACLR) measurement, 71

- View/Trace key, 73

acquisition packing

- WAVEform, 1040

active channel detection, code

- domain power measurement, 471, 481

active license key, 63

- how to locate, 63

Active Set Th (threshold) key

- Advanced menu, 240
- active set threshold
 - CDP, 562
- active set threshold mode
 - CDP, 562
 - modulation accuracy (rho), 613
- ADC Corr key, 328, 359
- ADC Dither key
 - spectrum measurement, 334
- ADC dithering
 - SPECTrum, 1024, 1041
- ADC filter
 - WAVEform, 1041
- ADC range
 - automatic control, 309
 - automatic peak control, 309
 - automatic peak lock, 309
 - code domain power, 787
 - manual control, 219, 309
 - modulation accuracy (rho), 925
 - QPSK EVM, 853
 - SPECTrum, 1024
 - WAVEform, 1042
- ADC Range key
 - spectrum measurement, 333
- ADC ranging function
 - automatic control, 219, 240, 265, 362
 - automatic control to peak, 219, 240, 265
 - automatic lock to peak, 219, 240, 266
 - automatic peak control, 362
 - automatic peak lock, 363
 - manual control, 241, 266, 363
- adjacent channel power
 - fast mode ADC range, 762
 - fast mode relative attenuation, 763
 - root raised cosine filter alpha, 763
 - root raised cosine filter state, 763
- adjacent channel power
 - measurement, 758
- adjacent channel power ratio
 - measurement, 658, 758
 - See also ACPR
- adjust timebase frequency, 754
- adjustment
 - 50 MHz reference, 666
- Advanced menu
 - Active Set Th (threshold) key, 240
 - spectrum, 332
- advanced menu

ADC dither, 363

- ADC range, 265, 309
- ADC ranging function, 240, 362
- alpha value, 293
- alpha value for RRC filter, 301
- chip rate, 240, 265, 293, 301, 308
- decimation, 363
- EVM result, include/exclude I/Q
 - Offset, 308
- fast FFT mode, 219
- FFT window, 283
- filter alpha, 240, 257, 265, 281, 308
- integration bandwidth, 257
- mask reference offset, 301
- number of data points, 230
- PRACH Threshold, 293
- pre-ADC bandpass filter, 362
- RBW filter, 293
- relative attenuation, 219
- resolution bandwidth, 230, 293, 301
- resolution bandwidth filter, 301, 362
- root-raised cosine filter, 257, 281
- RRC filter, 292, 301
- sweep time, 230
- tDPCH chip offset value
 - selection, 239
- trigger source, 230
- align 50 MHz reference, 666
- alpha value
 - RRC filter, 293
- amplitude
 - input range, 906
 - maximizing input signal, 907
- amplitude Y scale
 - reference position, 228, 232, 259, 276, 277, 285, 297, 306, 313, 314, 325
 - reference value, 228, 232, 259, 276, 277, 285, 297, 306, 313, 314, 325
 - scale coupling, 228, 232, 259, 277, 285, 297, 298, 306, 313, 314, 325
 - scale per division, 228, 232, 258, 276, 277, 285, 297, 306, 313, 314, 325
- Analog Filter key, 328, 359
- applications
 - currently available, 650
 - applications, selecting, 650, 652
- ASCII data format, 646
- attenuation

Index

- setting, 904
- average count
 - intermodulation, 865
 - multi carrier power, 872
- averaging
 - ACP, 758, 759
 - ACPR, 758, 759
 - CHPower, 847, 848, 879
 - modulation accuracy (rho), 928, 929
 - OBW, 878
 - power vs. time, 910, 911
 - QPSK EVM, 855
 - SPECTrum, 1026, 1027
 - traces, 881
 - transmit band spurs, 786, 787, 902, 903, 1043
 - WAVEform, 1043, 1044, 1045
- averaging count
 - spectrum emission mask, 979
- averaging state
 - intermodulation, 865, 872
 - power vs. time, 910
 - spectrum emission mask, 979
- averaging termination control
 - intermodulation, 866
 - multi carrier power, 873
- averaging type
 - maximum voltage averaging, 299
 - minimum voltage averaging, 299
 - rms power averaging, 299
- B**
- bandwidth
 - ACPR, 760
 - CHPower, 848
 - occupied bandwidth, 880
 - power vs. time, 913
 - PVTime, 914, 915
 - SPECTrum, 1031, 1032
 - spectrum emission mask, 980
 - WAVEform, 1045, 1047
- bar color settings
 - +10 MHz offset channel bar, 282
 - +15 MHz offset channel bar, 282
 - +5 MHz offset channel bar, 282
 - 5 MHz offset channel bar, 282
 - center carrier bar, 282
 - second carrier bar, 282
- base frequencies delta
 - intermodulation, 869
 - multi carrier power, 874
- base frequency auto search
 - intermodulation, 868
- base frequency setting
 - delta frequency (f1 - f0), 257
 - lower frequency (f0), 257
 - upper frequency (f1), 257
- base lower frequency
 - intermodulation, 869
- base station testing, 924
- base transmit station
 - loss correction, 852
- base upper frequency
 - intermodulation, 870
- Baseband I/Q inputs
 - key access table, 392
 - key entries, 392
 - key path, 392
- Baseband IQ measurements, 169
- basic mode, 182
- binary data order, 646
- Bit Format (DTX/Burst Detect), 239, 266
- Block Size key, 359
- broadband interference, 396
- BTS or MS selection
 - Device key, 195
- burst trigger
 - level, 1056
- byte order of data, 646
- C**
- capture interval
 - eight frames (long mode), 238
 - four frames (long mode), 238
 - one frame (full mode), 238, 260
 - one slot (fast mode), 238, 260
 - two frames (full mode), 238
- captured data block size
 - (wideband IF), 359
- captured data sample rate
 - (wideband IF), 359
- CCDF measurement, 718
- CDMA measurement, 702, 758, 787, 847, 925
- cdma2000
 - ACP measurement, 764
 - averaging, 855
 - offset frequencies, 987, 1005, 1006, 1020
 - offset frequencies auto mode, 988, 989, 1007
 - spectrum emission mask
 - measurement, 996, 998, 1000, 1002, 1003, 1004, 1013, 1014, 1016, 1017, 1018, 1019
 - trigger source, 842, 858, 1022
- cdma2000 measurement, 658, 703, 706, 711, 718, 724, 746, 758, 853, 865, 878, 908, 979
- cdmaOne
 - ACP measurement, 764, 780
 - trigger source, 842
- cdmaOne measurement, 658, 667, 713, 724
- CDP
 - active set threshold, 562
 - active set threshold mode, 562
 - computation type, 578
 - data bit format, 564
 - sweep offset, 573
 - sweep time, 575
 - time offset detection, 577
 - time offset for DPCH, 576
- CDPower
 - chip rate, 791
 - data capture time, 790
 - scramble code, 842
 - scramble code offset, 841
 - scramble code up link, 842
 - selecting spectrum type, 836
 - symbol rate, 844
 - trigger source, 845
- center frequency setting, 863
- center frequency step size, 864
- changing
 - instrument settings, 758
- channel power
 - advanced menu, 458
 - amplitude Y scale, 232
 - changing display, 232, 295
 - channel bandwidth, 458
 - power spectral density, 458
 - time record length, 458
- Channel Power key
 - MEASURE key, 77
- Channel power measurement, 76
- channel power measurement
 - See also CHPower
- channel power measurement, 702, 847
- chip rate
 - CDPower, 791
 - modulation accuracy (rho), 930
 - power control, 888
 - power control measurement, 293
 - power vs. time, 915
 - QPSK EVM, 856
- Choose Option key, 62
- CHPower
 - number of points, 849, 850
 - sweep time, 850, 851
 - trigger source, 851
- Code Domain
 - Symbol EVM, 91
- code domain

- advanced menu, 240
 - capture interval setup, 193, 238, 239, 260
 - changing displays, 250
 - changing measurement setup, 233
 - changing views, 245
 - chip dots display, 250
 - code domain power composite view, 459
 - code number, 233
 - I/Q branch selection, 233
 - I/Q gain imbalance, 459
 - I/Q modulation impairments, 459
 - I/Q quadrature error, 459
 - in-channel characteristics, 459
 - marker function
 - despread marker position, 255
 - marker menu
 - trace selection, 307
 - measurement interval, 234
 - measurement keys, 233
 - measurement method, 472
 - measurement offset, 234
 - power measurement type, 233
 - primary scramble code, 235
 - purpose, 459
 - scramble code (for MS), 236
 - scramble code offset, 235
 - scramble code type, 236
 - slot format, 235
 - spectrum, 240
 - spread channels, 472
 - symbol boundary, 236, 292
 - symbol rate, 233
 - sync channel type, 235
 - width of channel, 459
 - code domain (quad view)
 - power graph window, 250, 251, 252, 253, 254, 276, 277, 312, 313, 314
 - Code Domain (Quad View) key
 - View/Trace key, 83, 89, 91
 - code domain error limit
 - modulation accuracy (rho) (BTS), 614
 - code domain error limit (BTS)
 - cdma2000, 614
 - W-CDMA (3GPP), 614
 - Code Domain key
 - MEASURE key, 80, 87
 - View/Trace key, 83, 84, 85, 89, 90, 91
 - Code Domain measurement
 - Demodulated Bits, 467
 - Peak Code Domain Error, 463
 - Symbol EVM, 464
 - code domain measurement
 - MICH code number, 242
 - multi channel estimator, 241, 266
 - PICH code number, 242
 - timing estimation, 241, 266
 - using markers, 254
 - using print function, 255
 - code domain power
 - ADC range, 787
 - demod alpha, 789
 - code domain power measurement, 667, 713, 787
 - active channel detection, 471, 481
 - demod bit format, 250
 - SCH Suppress, 92
 - See also CDPower
 - code domain power window
 - marker, 249
 - marker to de-spread, 249
 - symbol EVM polar vector, 249
 - symbol power, 249
 - code, programming
 - compatibility across PSA modes, 557, 559
 - compatibility, PSA series versus VSA, 560
 - commands
 - compatibility across PSA modes, 557, 559
 - CONFigure, 656
 - FETCh, 656
 - MEASure, 655
 - PSA series versus VSA compatibility, 560
 - READ, 657
 - compatibility, programming
 - across PSA modes, 557
 - PSA series versus VSA, 560
 - composite EVM measurement, 260, 476
 - CONFigure command use, 654
 - CONFigure commands, 656
 - constellation type
 - QPSK EVM, 856
 - continuous vs. single
 - measurement mode, 648
 - control measurement commands, 648
 - correction
 - base transmit station loss, 852
 - mobile station loss, 852
 - corrections
 - wideband ADC corrections, 328, 359
 - correlative code, 396
 - current measurement, 619
 - current measurement, query, 658
 - curve fit the data, 580, 590
- ## D
- data
 - querying, 580, 590
 - data block size, 359
 - data capture length
 - power control, 887
 - data capture time
 - CDPower, 790
 - data decimation, 1033
 - WAVEform, 1047, 1048
 - data format, 646
 - data from measurements, 654
 - Data Packing
 - spectrum measurement, 334, 363
 - data sample rate, 359
 - Data Sharing
 - measurement setup compatibility, 197, 206
 - Data Source (Shared data) key, 196, 205
 - Decimation
 - spectrum measurement, 334
 - decimation
 - SPECtrum, 1033
 - decimation of data
 - WAVEform, 1047, 1048
 - default states, 69
 - default values, setting remotely, 656
 - deleting an
 - application/personality, 56
 - delta markers, 597
 - demod alpha
 - code domain power, 789
 - modulation accuracy (rho), 927
 - QPSK EVM, 854
 - Demod Bit Format
 - code domain power measurement, 250
 - Demod Bits key
 - View/Trace key, 85, 90
 - Demodulated Bits
 - Code Domain measurement, 467
 - demodulated bits view
 - power graph window, 250, 251, 252
 - demodulated bits window
 - display
 - chip phase on | off, 296
 - first page, 250, 295

Index

- last page, 250, 295
- next page, 250, 295
- previous page, 250, 295
- scroll down, 250, 295
- scroll up, 250, 295
- slot number, 295
- detection type
 - average power, 321
 - peak power, 321
- Device key
 - BTS or MS selection, 195
 - Radio key, 77, 195
- digital communications technique
 - direct sequence
 - spread-spectrum, 396
- display
 - +45 degrees rotation, 275, 312
 - absolute peak power levels & frequencies, 325
 - bar color settings, 282
 - chip dots, 275, 312
 - chip offset, 275, 312
 - I/Q chips, 275, 312
 - integrated power levels, 325
 - intermodulation products lines, 259
 - interpolation, 275, 312
 - limit lines, 325
 - on/off, 622
 - PVT limits, 624
 - relative peak power levels & frequencies, 325
 - spectrum window, 627, 628, 634, 635
 - trace, 629
 - window focus move control, 636
 - x-axis couple control, 637
 - x-axis reference level, 639
 - x-axis reference position, 640
 - x-axis scale/div, 638
 - y-axis couple control, 640
 - y-axis reference level, 642
 - y-axis reverence position, 643
 - y-axis scale/div, 641
 - zoom, 622
- display ACP data, 620
- display commands, 620
- display key
 - limit mask, 305
- display PVT data, 625
- dithering the ADC, 1024, 1041
- DTX/Burst, Code Domain
 - measurement, 239, 266
- E**
 - EVM window, 253, 254
 - external attenuator
 - BTS tests, 199, 208
 - MS tests, 199, 208
 - external reference, 977, 978
 - external trigger
 - delay, 1051
 - level, 1052
 - slope, 1052
- F**
 - fail condition
 - absolute AND relative, 280
 - absolute limit, 280
 - absolute OR relative, 280
 - relative limit, 280
 - fail conditions
 - absolute AND relative, 213
 - absolute level, 213
 - absolute OR relative, 214
 - relative level, 213
 - fail mask condition
 - absolute limit, 318, 320
 - absolute limit AND relative limit, 318, 320
 - absolute limit OR relative limit, 318, 320
 - relative limit, 318, 320
 - fast mode ADC range
 - adjacent channel power, 762
 - fast mode offset
 - ADC ranging function, 219
 - fast mode relative attenuation
 - adjacent channel power, 763
 - FETCh command use, 654
 - FETCh commands, 656
 - FFT
 - SPECTrum, 1033, 1034, 1035, 1036
 - FFT bandwidth, SPECTrum, 1029, 1030, 1031
 - FFT Length key, 329, 333
 - FFT Size menu, 329, 333
 - FFT window
 - Blackman filter, 283
 - Blackman-Harris filter, 283
 - flat top filter, 283
 - Gaussian filter with alpha 3.5, 283
 - Hamming filter, 283
 - Kaiser-Bessel 110 dB filter, 283
 - Kaiser-Bessel 70 dB filter, 283
 - Kaiser-Bessel 90 dB filter, 283
 - occupied bandwidth, 880
 - uniform filter, 283
 - FFT Window key., 328, 332
 - FFT, Swp, or Fast selection
 - Sweep Type key, 74
 - filter
 - gain setup (wideband), 327, 358
 - setup (wideband), 327, 359
 - type (wideband), 359
 - filter alpha
 - power vs. time, 915
 - Filter Alpha key, 327, 359
 - Filter BW key, 327, 359
 - filter control
 - power vs. time, 916
 - Filter Type key, 327, 359
 - Flat Top key, 327, 359
 - format, data, 646
 - frame trigger adjustment, 1052
 - frame trigger period, 1053
 - frequencies offset
 - ACP, 767
 - frequency
 - center, 863
 - step size, 864
 - frequency band limits
 - OBW, 604
 - frequency channel
 - center frequency, 190
 - center frequency step, 190
 - changing, 190
 - frequency error limit test
 - RHO, 615
 - frequency span
 - CHPower, 849
 - SPECTrum, 1037
 - spectrum emission mask, 984
 - FT window
 - Hanning filter, 283
 - Full Screen key, 623
- G**
 - Gaussian key, 327, 359
 - GSM measurement, 910
- H**
 - higher level security, 396
 - HSDPA
 - Shared Control Channel (HS-SCCH), 421
 - HSDPA/HSUPA Enable, 204
 - HSUPA cell connections, 453
 - HSUPA concepts, 446
 - HSUPA downlink channels, 447
 - HSUPA downlink channels
 - E-AGCH, 447
 - HSUPA downlink channels
 - E-HICH, 447
 - HSUPA downlink channels
 - E-RGCH, 449
 - HSUPA DPCHE/E-DPCH Code Domain Configurations, 452

- HSUPA DPCHE/E-DPCH
 - Configurations, 451
- HSUPA protocol and channels, 446
- HSUPA Uplink Data Rates, 453
- HSUPA uplink physical channels, 449
- HSUPA uplink physical channels
 - E-DPCCH, 449
- HSUPA uplink physical channels
 - E-DPDCH, 450
- I**
- I and Q waveform view
 - I or Q waveform window, 356
 - I waveform window, 382
 - Q waveform window, 382
- I offset, 198, 206
- I or Q waveform window
 - amplitude Y scale, 356
 - reference position, 356
 - reference value, 356
 - scale coupling, 356
 - scale per division, 356
 - span X scale
 - reference position, 354, 379
 - reference value, 354, 379
 - scale coupling, 355, 379
 - scale per division, 354, 379
- I origin
 - I/Q polar window, 380, 382
- I Origin key, 355, 356
- I waveform window
 - amplitude Y scale, 382
 - reference position, 382
 - scale coupling, 382
 - scale per division, 382
- I/Q data output, 182
- I/Q data results, 752, 756
- I/Q error (quad view)
 - EVM graph window
 - amplitude Y scale, 276, 277
 - magnitude error graph window
 - amplitude Y scale, 276, 277
- I/Q Error (Quad View) key
 - View/Trace key, 84, 102, 124
- I/Q error graph view
 - EVM window, 253, 254
 - phase error window, 253
- I/Q impedance reference, 198, 207
- I/Q input impedance, 198, 207
- I/Q marker query, 618
- I/Q Measured Polar Constln key
 - View/Trace key, 101, 123
- I/Q Polar view
 - waveform measurement, 380, 382
- I/Q polar view
 - I/Q polar window, 355, 356, 380, 382
- I/Q polar window
 - amplitude Y scale, 356
 - I/Q scale per division, 355, 356
 - Q Origin, 355, 356
 - I origin, 380, 382
 - I/Q scale per division, 380, 382
 - Q origin, 380, 382
 - span X scale, 355, 356
 - I Origin, 355, 356
 - I/Q scale per division
 - I/Q polar window, 380, 382
 - I/Q Scale/Div key, 355, 356
 - I/Q setup, 198, 206
 - I/Q waveform view
 - I/Q waveform window, 382
 - I/Q waveform window, 379
 - amplitude Y scale, 382
 - reference position, 382
 - reference value, 382
 - scale coupling, 382
 - scale per division, 382
- I1, Q1, I2, Q2, 251
- iDEN
 - ACP measurement, 764
 - trigger source, 881
- iDEN measurement, 711, 878
- iDEN offset frequencies, 767
- IF BW key, 358
- IF filter
 - gain setup, 327, 358
 - setup, 359
 - type, 359
- IF Flat Corr key, 328, 359
- IF Flatness
 - advanced spectrum feature, 334
- IF path filter
 - alpha, 327, 359
 - bandwidth, 327, 359
 - setup, 327
 - type, 327
- IF Path key, 332, 362
- IF setup, 327, 358
- IF trigger delay, 1054
- IF trigger level, 1055
- IF trigger slope, 1055
- increased capacity
 - frequency reuse, 396
 - sectored cells, 396
- initial signal connection, 69
- initiate measurement, 648, 649
- input
 - external attenuator, 199, 208
 - input attenuator, 199, 200, 208, 209
 - input port
 - Baseband Align Signal, 195, 204
 - max total power, 199, 208
 - input attenuation, 904
 - input port, 195, 204
 - 50 MHz reference, 195, 204
 - I only, 195, 204
 - I/Q, 195, 204
 - IF align, 195, 204
 - Q only, 195, 204
 - RF, 195, 204
 - input port selection, 859
 - input power
 - maximum, 907
 - range, 906
 - input range, 198, 207
 - Install Now key, 62
 - Installing and Obtaining a license key, 61
 - installing measurement personalities, 56
 - instrument configuration, 650
 - integration bandwidth
 - intermodulation, 866
 - Intermod key
 - MEASURE key, 96
 - intermodulation
 - average count, 865
 - averaging state, 865, 872
 - averaging termination control, 866
 - base frequencies delta, 869
 - base frequency auto search, 868
 - base lower frequency, 869
 - base upper frequency, 870
 - changing displays, 258
 - changing measurement setup, 256
 - integration bandwidth, 866
 - intermodulation graph, 96
 - measurement method, 475
 - measurement mode, 871
 - measurement reference, 871, 877
 - purpose, 475
 - resolution bandwidth, 867
 - resolution bandwidth state, 867
 - root raised cosine filter alpha, 867
 - root raised cosine filter state, 868
 - span, 870
 - transmit IM, 256, 257, 315, 316
 - transmit intermodulation products, 475

Index

- two-tone intermodulation products, 475
 - Intermodulation measurement, 94
 - intermodulation measurement, 706, 865
 - See also IM
 - internal reference, 978
 - internal reference selection, 859
 - Internal RF Preamplifier, 200, 209
 - IQ input selection, 859
 - IQ port selection, 859
- K**
- key flow diagram
 - acpr, 514
 - channel power, 514
 - code domain, 514
 - intermodulation, 514
 - measurement menu, 514
 - mode selection, 514
 - mode setup/frequency channel, 514
 - modulation accuracy (rho), 514
 - multi carrier power, 514
 - occupied bandwidth, 514
 - power control, 514
 - power stat CCDF, 514
 - power versus time, 514
 - QPSK EVM, 514
 - spectrum (frequency domain), 514
 - spectrum emission mask, 514
 - waveform (time domain), 514
- L**
- length
 - QPSK EVM, 858
 - Length Ctrl key, 329, 333
 - Length key, 329, 333
 - level
 - external front, 202
 - external rear, 202
 - RF burst, 202
 - video (envelope), 202
 - license key
 - obtaining and installing, 61
 - limit line testing, 658
 - limit testing
 - OBW, 604, 606
 - limits
 - composite peak EVM, 261
 - composite rho, 261
 - composite rms EVM, 261
 - peak code domain error, 261
 - linear envelope view
 - linear envelope window, 381
 - phase window, 381
 - linear envelope window, 379
 - amplitude Y scale, 381
 - reference position, 381
 - reference value, 381
 - scale coupling, 381, 382
 - scale per division, 381
 - linear spectrum window
 - amplitude Y scale
 - reference position, 355
 - reference value, 355
 - scale coupling, 355
 - scale per division, 355
 - span, 354
 - loading an
 - application/personality, 56
- M**
- magnitude error window
 - amplitude Y scale
 - reference position, 253
 - reference value, 253
 - scale coupling, 254
 - scale per division, 253
 - span X scale, 253
 - reference position, 253
 - reference value, 253
 - scale coupling, 253
 - scale per division, 253
 - major functional keys, 186
 - making measurements, 654
 - marker
 - function
 - band power, 288
 - noise, 288
 - off, 288
 - I/Q query, 618
 - selection of 1/2/3/4, 254
 - selection of functions, 255
 - selection of shapes, 255
 - selection of traces, 255
 - setting to delta readout, 254
 - setting to normal readout, 254
 - shape
 - cross, 288
 - diamond, 288
 - line, 288
 - square, 288
 - trace
 - Gaussian curve, 288
 - measured curve, 288
 - reference curve, 288
 - turning off all markers, 255
 - turning off the marker, 255
 - marker menu
 - erase a marker, 298, 307
 - erase all markers, 298, 307
 - marker functions, 298, 307
 - normal reading, 298, 307
 - reading the difference, 298, 307
 - select 1 through 4, 298, 307
 - shape selection, 298, 307
 - trace selection, 298, 307
 - markers, 592
 - assigning them to traces, 598
 - maximum, 596
 - minimum, 597
 - off, 598
 - trace assignment, 602, 603
 - turn off, 595
 - type, 597
 - valid measurement, 592
 - value, 604
 - value of, 596
 - x-axis location, 602, 603
 - y-axis, 604
 - masks
 - power vs. time, 916, 917, 918, 920, 921
 - maximum value of trace data, 580, 590
 - mean value of trace data, 580, 590
 - Meas Control key
 - Measure key, 85, 93, 113, 116, 119
 - Meas Mode key
 - 3rd IM Only key, 106
 - Meas Setup key, 106
 - Meas Setup key
 - 2nd Carrier Offset key, 105
 - Meas Mode key, 106
 - Multi Carrier Power key, 105
 - Ref Chan key, 105
 - Spectrum Segment key, 147
 - Meas setup key
 - Spectrum Emission Mask key, 147
 - Meas Time key, 358
 - MEASure command use, 654
 - MEASure commands, 655
 - MEASURE key
 - Channel Power key, 77
 - Code Domain key, 80, 87
 - Intermod key, 96
 - Mod Accuracy (Composite EVM) key, 99
 - Multi Carrier Power key, 104
 - Occupied BW key, 108
 - Power Stat CCDF key, 111, 115, 118
 - QPSK EVM key, 121
 - Spectrum Emission Mask key, 146

- Measure key
 - Meas Control key, 85, 93, 113, 116, 119
 - Single or Cont selection, 85, 93, 113, 116, 119
- measure mode
 - automatic search mode, 256
 - transmit intermodulation, 256
 - two-tone intermodulation, 256
- measure setup
 - advanced menu, 257, 283
 - automatic search for base frequency signal, 256
 - bandwidth limit, 283
 - base frequency setting, 257
 - frequency span, 256, 283
 - limit test function, 283
 - measure mode, 256
 - reference signal, 256
 - resolution bandwidth, 256, 283
 - restore measurement defaults, 218, 230, 240, 257, 265, 281, 283, 286, 293, 301, 308, 322, 332, 362
- measurement
 - adjacent channel power, 758
 - adjacent channel power ratio, 758
 - channel power, 229, 458, 847
 - code domain, 459
 - code domain power, 787
 - intermodulation, 256, 475, 865
 - markers, 592
 - modulation accuracy (composite EVM), 260, 476
 - modulation accuracy (rho), 925
 - multi carrier power, 279, 482
 - multi carrier power measurement, 872
 - occupied bandwidth, 283, 484
 - spectrum shape, 484
 - occupied BW, 878
 - power statistics CCDF, 286, 488
 - power statistics CCDF measurement, 908
 - power vs. time, 910
 - QPSK error vector magnitude, 853
 - QPSK EVM, 308, 492
 - phase and frequency quality, 492
 - query current, 619
 - spectrum (frequency domain), 1023
 - spectrum emission mask, 315, 498, 979
 - spurious emissions and ACP, 979
 - waveform (time domain), 1040
- measurement control, 194
- measure, 194
 - continuous, 194
 - single, 194
- pause, 194
 - resume, 194
- restart, 194
- measurement data type
 - power control, 889
- measurement delay
 - power control, 608
- measurement interval
 - power control, 606
- measurement keys
 - code domain, 233
- measurement mode
 - all channels, 280
 - intermodulation, 871
 - third order intermodulation only, 280
 - third/fifth/seventh orders intermodulation, 280
- measurement modes
 - currently available, 650
 - selecting, 650, 652
- measurement offset
 - power control, 607
- measurement reference
 - intermodulation, 871, 877
- measurement reference type
 - power spectral density reference, 321
 - spectral power density reference, 217
 - total power reference, 217, 321
- measurement selection, 191
 - adjacent channel power ratio, 191
 - channel power, 191
 - code domain, 192
 - intermodulation products, 191
 - modulation accuracy (rho), 192
 - multi carrier power, 191
 - occupied bandwidth, 192
 - power control, 194
 - power statistics CCDF, 193
 - power versus time mask, 194
 - QPSK EVM, 193
 - spectrum (frequency domain), 193
 - spectrum emission mask, 192
 - spurious emission, 192
 - waveform (time domain), 193
- measurement setup
 - advanced menu, 230
 - averaging mode, 211, 229, 260, 330, 360
 - exponential, 211, 229, 260, 330, 360
 - averaging number, 211, 229, 260, 329, 360
 - averaging type, 330, 360
 - log power average (video), 330, 360
 - maximum voltage average, 330, 360
 - minimum voltage average, 330, 360
 - power average (rms), 330, 360
 - voltage average, 330, 360
 - channel power span, 230
 - integration bandwidth, 229
 - time averaging number, 331, 361
- measurement type
 - power control, 900
- measurements
 - adjacent channel power ratio, 658
 - CCDF, 718
 - channel power, 702
 - code domain power, 667, 713
 - CONF/FETC/MEAS/READ commands, 654
 - control of, 648
 - getting results, 654
 - intermodulation, 706
 - modulation accuracy, 724
 - multi carrier power, 709
 - occupied BW, 711
 - power stat, 718
 - power versus time, 299, 491
 - power vs. time, 720
 - QPSK error vector magnitude, 703
 - query current, 658
 - setting default values remotely, 656
 - single/continuous, 648
 - spectrum (frequency domain), 752
 - spectrum emission mask, 746
 - waveform (time domain), 755
- measuring I/Q data, 752, 756
- measuring in the time domain, 167
- measuring mode
 - all channels, 482
 - third order intermodulation only, 482, 483

Index

- third/fifth/seventh orders
 - intermodulation, [482](#), [483](#)
 - MICH code number
 - code domain measurement, [242](#)
 - mod accuracy measurement, [267](#)
 - Min Pts in RBW key, [329](#), [333](#)
 - minimum value of trace data, [580](#), [590](#)
 - missing options, [56](#)
 - mobile station
 - loss correction, [852](#)
 - mobile station testing, [924](#)
 - mod accuracy
 - measurement offset setup, [261](#)
 - sync channel type
 - antenna-1 TSTD SCH, [262](#)
 - antenna-2 CPICH, [262](#)
 - antenna-2 TSTD SCH, [262](#)
 - code symbol based (for BTS), [261](#)
 - CPICH channel (for BTS), [261](#)
 - DPCCH, [262](#)
 - PRACH message, [262](#)
 - STTD Diff, [262](#)
 - Mod Accuracy (Composite EVM)
 - key
 - MEASURE key, [99](#)
 - View/Trace key, [101](#)
 - mod accuracy measurement
 - MICH code number, [267](#)
 - PICH code number, [267](#)
 - Symbol evm compensation, [242](#)
 - Mod Scheme selection, [234](#)
 - MODE key, [77](#)
 - W-CDMA (3GPP) key, [77](#)
 - mode setup
 - changing, [195](#)
 - input condition, [195](#)
 - input/output key, [204](#)
 - radio configuration, [195](#)
 - trigger, [201](#)
 - trigger condition, [201](#)
 - Mode Setup key
 - Radio key, [77](#), [195](#)
 - W-CDMA (3GPP) key, [77](#)
 - modulation accuracy (composite EVM), [260](#), [476](#)
 - advanced menu, [265](#)
 - capture time summary, [273](#)
 - changing displays, [275](#), [312](#)
 - changing measurement setup, [260](#)
 - changing views, [269](#), [310](#)
 - device BTS
 - primary scramble code, [262](#)
 - scramble code, [262](#)
 - scramble code offset, [262](#)
 - scramble code type, [262](#)
 - symbol boundary, [263](#)
 - high modulation quality (rho=1), [480](#)
 - I/Q error quad view, [311](#)
 - I/Q error tri-view, [270](#)
 - I/Q measured polar vector view, [269](#), [310](#)
 - I/Q origin offset, [480](#)
 - limits, [261](#)
 - marker key menu, [278](#)
 - maximum spreading factor, [480](#)
 - measurement method, [480](#)
 - modulation quality
 - rho, [476](#)
 - peak/average metrics view, [272](#)
 - purpose, [476](#)
 - rho, [480](#)
 - slot CDE/EVM view, [193](#), [274](#)
 - spectrum, [265](#)
 - sync channel type, [261](#), [262](#)
 - transmission chain, [476](#)
 - modulation accuracy (composite EVM) code domain power view, [271](#)
 - modulation accuracy (rho)
 - active set threshold mode, [613](#)
 - scramble code down link, [971](#)
 - scramble code up link, [973](#)
 - sync type, [970](#)
 - modulation accuracy (rho) (BTS)
 - code domain error limit (BTS), [614](#)
 - rho limit, [616](#)
 - RMS EVM limit, [616](#), [617](#)
 - modulation accuracy (rho)
 - measurement, [925](#)
 - See also RHO
 - modulation accuracy
 - measurement, [724](#)
 - multi carrier estimator
 - modulation accuracy (rho), [931](#)
 - multi carrier power, [872](#)
 - advanced menu, [281](#)
 - average count, [872](#)
 - averaging termination control, [873](#)
 - base frequencies delta, [874](#)
 - changing displays, [282](#)
 - changing measurement setup, [279](#)
 - changing views, [281](#)
 - measurement mode, [279](#)
 - measuring mode, [482](#)
 - method, [482](#)
 - offset frequency absolute limit, [874](#), [875](#)
 - offset frequency test mode, [876](#)
 - offset select, [877](#)
 - offsets & limits, [280](#)
 - purpose, [482](#)
 - reference channel selection, [279](#)
 - root raised cosine filter alpha, [873](#)
 - root raised cosine filter state, [873](#)
 - second carrier offset, [279](#)
 - multi carrier power amplifier, [482](#)
 - Multi Carrier Power key
 - Meas Setup key, [105](#)
 - MEASURE key, [104](#)
 - Multi carrier power
 - measurement, [103](#)
 - multi carrier power
 - measurement, [709](#), [872](#)
 - See also MCPower
 - multi channel estimator
 - code domain measurement, [241](#), [266](#)
- ## N
- NADC
 - offset frequencies, [767](#)
 - NADC measurement, [758](#)
 - noise floor setting for PRACH
 - detection, [890](#)
 - normal marker, [597](#)
- ## O
- OBW
 - limit testing, [604](#), [606](#)
 - trigger source, [881](#)
 - OBW averaging, [878](#)
 - occupied bandwidth
 - 99.0% bandwidth, [484](#)
 - changing displays, [285](#)
 - changing measurement setup, [283](#)
 - FFT window, [880](#)
 - measurement method, [484](#)
 - purpose, [484](#)
 - total absolute power, [484](#)
 - Occupied Bandwidth
 - measurement, [107](#)
 - Occupied BW key
 - MEASURE key, [108](#)
 - occupied BW measurement, [711](#), [878](#)
 - See also OBW
 - offset frequencies, [780](#)
 - ACP, [767](#)

- spectrum emission mask, 987, 1005, 1006, 1020
- offset frequencies auto mode spectrum emission mask, 988, 989, 1007
- offset frequency absolute limit multi carrier power, 874, 875
- offset frequency test mode multi carrier power, 876
- Offset or Region selection Spectrum Segment key, 147
- offset segment offsets & limits, 316
- offset select multi carrier power, 877
- offsets & limits absolute limit, 280 absolute limits, 213 fail condition, 280 fail conditions, 213 limits, 317 absolute start level, 317 absolute stop level, 317 fail mask condition, 318 relative start level, 317 relative stop level, 317 measurement (integration) bandwidth, 317 offset, 280 offset channel memory, 212 offset frequency, 213 offset side, 317 offsets, 316 reference bandwidth, 213 relative attenuation, 317 relative limit, 280 relative limit (carrier level), 214 relative limit (PSD level), 214 resolution bandwidth, 316 start frequency, 316 step frequency, 316 stop frequency, 316
- Option 122 wideband selection, 332, 362
- options loading/deleting, 56 options not in instrument memory, 56
- P**
- packing SPECTrum, 1023
- pass/fail test, 658
- PDC offset frequencies, 767 trigger source, 881 PDC measurement, 711, 758, 878
- Peak Code Domain Error Code Domain measurement, 463 personalities currently available, 650 selecting, 650, 652 personality options not in instrument, 56 phase error window, 253 amplitude Y scale reference position, 252, 254 reference value, 254 scale coupling, 252, 254 scale per division, 254 phase inversion, 836 phase window, 379 amplitude Y scale, 381 reference position, 381 reference value, 381 scale per division, 381 PICH code number code domain measurement, 242 code mod accuracy measurement, 267 points/measurement CHPower, 849, 850 power control, 606, 883 power control chip rate, 888 power control data capture length, 887 power control measurement, 289, 485 advanced menu, 293 amplitude Y scale, 296 capture interval, 292 marker menu Best-Fit Phase trace selection, 298 Chip Phase trace selection, 298 Phase Discontinuity trace selection, 298 RF envelope trace selection, 298 Slot Power trace selection, 298 trace selection, 298 measurement method, 291 measurement type, 289, 292 PRACH, 289 slot, 289 slot phase, 289, 291 PRACH power measurement, 290 PRACH preamble, 292 slot format, 289, 290, 292 slot power measurement, 290 power control measurement data type, 889 power control measurement delay, 608 power control measurement interval, 606 power control measurement offset, 607 power control measurement type, 900 power control PRACH message length, 607 power control PRACH preamble length, 608 power control PRACH preamble noise floor setting, 890 power control PRACH preamble signature, 891 power control PRACH preamble signature detection, 891 power control RBW filter type, 886 power control resolution bandwidth, 885 power control root raised cosine alpha, 888 power control root raised cosine control, 889 power control uplink scramble code, 899 power graph and metrics view power graph window, 250 power graph window amplitude Y scale, 251 reference value, 251 scale per division, 251 display code channels with symbol rate, 250 composite on or off, 250 span X scale expand, 251 reference position, 251 reference value, 251 scale per division, 251 power stat CCDF Gaussian line display, 287 Power Stat CCDF key MEASURE key, 111, 115, 118 power statistic CCDF cdma2000, 611 store reference, 611 W-CDMA (3GPP), 611 power statistics CCDF band limited Gaussian noise CCDF reference line, 490 changing displays, 287

Index

- changing measurement setup, 286
- combining the multiple signals, 488
- correlation between symbols on different codes, 488
- digital signal processing, 490
- Gaussian distribution curve, 490
- instantaneous envelope power, 490
- marker
 - all markers off, 288
 - delta readout, 288
 - measurement function, 288
 - normal readout, 288
 - off, 288
 - selection of numbers, 288
 - shape, 288
 - trace, 288
- measurement bandwidth, 286
- measurement interval, 286
- measurement method, 490
- modulation filtering, 488
- modulation format, 488
- number of active codes, 488
- number of sampling points, 286
- power complementary
 - cumulative distribution function curves, 488
- probability for that particular power level, 490
- purpose, 488
- reference trace display, 287
- span X scale
 - scale per division, 287
- store reference trace, 287
- using markers, 288
- power statistics CCDF
 - measurement, 908
 See also PSTat
- power versus time
 - changing the view, 304
 - measurements, 299, 491
- power versus time measurement
 - view/trace selection, 304
- power vs time measurement
 - advanced menu, 301
 - amplitude Y scale, 306
 - averaging type, 299
 - burst search threshold, 300
 - changing display, 305
 - setting region and limits, 299
 - time reference, 300
- power vs. time
 - averaging state, 910
 - power vs. time - averaging mode, 911
 - power vs. time - averaging type, 911
 - power vs. time - chip rate, 915
 - power vs. time - limit line mask display, 916
 - power vs. time - lower mask relative amplitude levels, 916
 - power vs. time - mask interval, 918
 - power vs. time - mask offset, 918
 - power vs. time - mask power reference, 917
 - power vs. time - number of data acquisitions averaged, 910
 - power vs. time - resolution bandwidth, 913
 - power vs. time - root raised cosine filter alpha, 915
 - power vs. time - root raised cosine filter control, 916
 - power vs. time - trigger source, 922
 - power vs. time - upper mask relative amplitude levels, 917, 918, 920, 921
 - power vs. time measurement, 720, 910
 - See also PVTime
- PRACH detection improvement, 890
- PRACH message length
 - power control, 607
- PRACH power measurement
 - measurement offset, 291
 - message length, 291
 - offset power interval, 291
 - preamble length, 291
- PRACH preamble
 - Auto, 292
 - preamble, 292
- PRACH preamble length
 - power control, 608
- PRACH preamble noise floor
 - power control, 890
- PRACH preamble signature
 - power control, 891
- PRACH preamble signature detection
 - power control, 891
 - RHO, 935
- PRACH Threshold
 - power control measurement, 293
- pre-ADC bandpass filter
 - SPECTrum, 1029
- Pre-ADC BPF key
 - spectrum measurement, 332
- Preamplifier
 - Setting the internal preamplifier, 200, 209
- pre-amplifier
 - attenuator, 905
 - on/off, 904
- predefined test models
 - test model 1 with 16-DPCH channels, 236, 237, 263, 264
 - test model 1 with 32-DPCH channels, 263
 - test model 1 with 64-DPCH channels, 236, 263
 - test model 2, 237, 264
 - test model 3 with 16-DPCH channels, 237, 264
 - test model 3 with 32-DPCH channels, 237, 264
 - test model 5 with 2 HS-PDSCH channels, with 6 DPCH channels, 237, 264
 - test model 5 with 4 HS-PDSCH channels, with 14 DPCH channels, 237, 264
 - test model 5 with 8 HS-PDSCH channels, with 30 DPCH channels, 237, 264
- pre-derfined test models
 - test model 1 with 16-DPCH channels, 236, 263
 - test model 1 with 32-DPCH channels, 236
 - test model 1 with 64-DPCH channels, 237
 - test model 2, 237, 264
 - test model 3 with 32-DPCH channels, 237, 264
- pre-FFT bandwidth, SPECTrum, 1029, 1030, 1031
- Pre-FFT BW key, 332
- Pre-FFT Fltr key, 332
- preset, 69
 - factory defaults, 69
- Preset key, 77
- preset states, 69
- print setup
 - print demodulated bits data, 255
- procedure
 - using the waveform measurement, 167
- programming
 - compatibility among PSA modes, 557, 559

- compatibility, PSA series versus VSA, 560
- PSA series versus VSA (programming compatibility), 560
- Purpose, 476
- PVT
 - view of data, 625
- PVT limits display, 624
- PVTime
 - bandwidth, 914, 915
- Q**
- Q offset, 198, 206
- Q origin
 - I/Q Polar window, 380, 382
 - I/Q polar window, 380, 382
- Q Origin key, 355, 356
- Q waveform window
 - amplitude Y scale, 382
 - reference position, 382
 - reference value, 382
 - scale coupling, 382
 - scale per division, 382
- QPSK error vector magnitude measurement, 703, 853
- QPSK error vector measurement
 - See also EVMQpsk
- QPSK EVM
 - ADC range, 853
 - advanced menu, 308
 - averaging, 855
 - changing measurement setup, 308
 - chip rate, 856
 - constellation type, 856
 - demod alpha, 854
 - length, 858
 - limits, 308
 - measurement interval, 308
 - measurement method, 497
 - phase trajectory, 497
 - predefined constellation, 308
 - purpose, 492
 - quadrature phase shift keying modulation, 492
 - RF carrier mode, 857
 - spectrum normal/invert, 308, 857
 - theoretically perfect signal phase, 497
 - transmitted signal phase, 497
 - trigger source, 858
 - using markers, 314
- QPSK EVM key
 - MEASURE key, 121
 - View/Trace key, 123
- QPSKEVM
 - frequency error limit, 591
 - IQ offset include, 591
 - RMS EVM limit, 592
- query data, 580, 590
- R**
- Radio key
 - Device key, 77, 195
 - Mode Setup key, 77, 195
- Raised Cosine Key, 327, 359
- RBW filter
 - flattop, 293
 - Gaussian, 293
- RBW filter type
 - power control, 886
- READ command use, 654
- READ commands, 657
- real number data format, 646
- rear panel external trigger
 - delay, 1051
 - slope, 1052
- Ref Chan key
 - Meas Setup key, 105
 - Upper key, 105
- reference
 - external, 977, 978
 - internal, 978
- reference channel
 - channel integration bandwidth, 315
 - channel span, 315
 - resolution bandwidth, 315, 316
 - step frequency, 315
- reference channel resolution
 - bandwidth
 - spectrum emission mask, 981
- reference channel resolution
 - bandwidth auto mode
 - spectrum emission mask, 982
- reference channel selection
 - automatic reference setting, 279
 - average carrier reference, 279
 - lower carrier reference, 279
 - upper carrier reference, 279
- reference channel step frequency
 - spectrum emission mask, 985
- reference channel step frequency
 - auto mode list
 - spectrum emission mask, 986
- reference signal
 - automatic setting, 256
 - setting to the lower frequency, 256
 - setting to the upper frequency, 256
- reference, selecting internal, 859
- region advanced menu
 - relative attenuation, 321
- region segment
 - regions & limits, 316
- regions & limits
 - limits, 320
 - absolute start level, 320
 - absolute stop level, 320
 - fail mask condition, 320
 - relative start level, 320
 - relative stop level, 320
- regions, 319
- resolution bandwidth, 319
- start frequency, 319
- step frequency, 319
- stop frequency, 319
- Res BW key
 - spectrum measurement, 327
 - waveform measurement, 358
- resolution bandwidth
 - intermodulation, 867
 - power control, 885
- resolution bandwidth state
 - intermodulation, 867
- restart measurement, 649
- results, waveform measurement, 500
- return data, 580, 590
- RF carrier mode
 - QPSK EVM, 857
- RF input port gain setting when pre-amplifier is on, 905
- RF input port power gain, 904
- RF input selection, 859
- RF input, selection, 859
- RHO
 - CPICH error limit (BTS), 614
 - CPICH reference power (BTS), 615
 - frequency error limit test, 615
 - selecting symbol boundary, 958
 - spectrum type, 968
 - spread code, 974
 - symbol rate, 975
- rho limit
 - cdma2000 (BTS), 616
 - modulation accuracy (rho) (BTS), 616
 - W-CDMA (3GPP) (BTS), 616
- rho measurement, See modulation accuracy measurement, 260, 476
- RMS EVM limit
 - cdma2000 (BTS), 616, 617
 - modulation accuracy (rho) (BTS), 616, 617

- W-CDMA (3GPP) (BTS), 616, 617
- RMS of trace data, 580, 590
- Root Nyquist key, 327, 359
- root raised cosine alpha power control, 888
- root raised cosine control power control, 889
- root raised cosine filter alpha adjacent channel power, 763
- intermodulation, 867
- multi carrier power, 873
- root raised cosine filter state adjacent channel power, 763
- intermodulation, 868
- multi carrier power, 873
- RRC (root raised cosine) key, 327, 359
- S**
- Sample Rate key, 359
- sampling trace data, 580, 590
- SCH Supress, 92
- scramble code
 - CDPower, 842
- scramble code down link modulation accuracy (rho), 971
- scramble code for uplink power control, 899
- scramble code offset
 - CDPower, 841
- scramble code up link
 - CDPower, 842
 - modulation accuracy (rho), 973
- second carrier offset
 - +10 MHz, 279
 - +15 MHz, 279
 - +5 MHz, 279
 - 10 MHz, 279
 - 15 MHz, 279
 - 5 MHz, 279
- selecting the wideband/narrowband path, 332, 362
- sensitivity improvement for PRACH detection, 890
- set up the wideband IF, 327, 358
- setting region and limits interval, 300
- lower mask, 300
- offset start, 300
- offset stop, 300
- region selection, 299
- upper mask, 300
- setting second carrier offset, 482
- signal envelope view
 - signal envelope window, 380
- signal envelope window, 379
 - amplitude Y scale, 380
 - reference position, 380
 - reference value, 380
 - scale coupling, 380
 - scale per division, 380
- Single or Cont selection
 - Measure key, 85, 93, 113, 116, 119
- single vs. continuous measurement mode, 648
- slot format
 - chip power measurement, 289, 290, 292
- slot power measurement
 - measurement delay, 290
 - measurement interval, 290
 - PCG length, 290
 - slot offset, 290
- span
 - CHPower, 849
 - intermodulation, 870
 - selecting IF path, 332, 362
 - SPECTrum, 1037
- Span key
 - spectrum measurement, 327
- span X scale
 - reference position, 276, 296, 306, 313
 - reference value, 276, 296, 306, 313
 - scale coupling, 276, 296, 306, 313
 - scale per division, 276, 296, 306, 313
- SPECTrum
 - acquisition packing, 1023
 - ADC range, 1024
 - data decimation, 1033
 - FFT length, 1033, 1034
 - FFT resolution BW, 1035
 - FFT window, 1036
 - FFT window delay, 1035
 - frequency span, 1037
 - sweep time, 1038
 - trigger source, 1039
- spectrum
 - all traces, 354, 379
 - averaged trace, 354, 379
 - changing views, 130, 337
 - current trace, 354, 379
 - I signal trace, 354, 379
 - next window selection, 337
 - Q signal trace, 354, 379
 - span X scale, 354
 - trace display, 354, 379
 - view/trace, 130, 337
- zoom a window, 337
- Spectrum (Frequency Domain) key, 327, 499
- spectrum (frequency domain) measurement, 752, 1023
- See also SPECTrum
- spectrum emission mask
 - amplitude Y scale, 325
 - changing displays, 325
 - changing measurement setup, 315
 - changing views, 324
 - detector mode, 983
 - in-band and out-of-band spurious emissions, 498
 - integration bandwidth method, 498
 - measure setup
 - detection type, 321
 - measurement reference type, 321
 - trigger source, 239, 286, 322
 - measurement interval, 315, 1021
 - measurement method, 498
 - offset frequencies, 987, 1006
 - offset frequencies auto mode, 988, 989, 1007
 - offset or region frequency pairs, 498
 - offset segment
 - offsets & limits, 316
 - offset start frequency, 990, 1008
 - offset stop frequency, 991, 993, 1009, 1011
 - offset stop frequency auto mode, 992, 1010
 - power reference, 1022
 - purpose, 498
 - reference channel, 315
 - reference channel integration bandwidth, 498
 - relative attenuation, 994, 1012
 - setting amplitude levels, 996, 998, 1000, 1002, 1003, 1004, 1013, 1014, 1016, 1017, 1018, 1019
 - spectral regrowth, 498
 - spectrum segment, 316
 - testing choices, 999, 1015
 - trigger source, 1022
 - using markers, 326
- Spectrum Emission Mask key
 - Meas Setup key, 147
 - MEASURE key, 146
- Spectrum Emission Mask measurement, 145

- spectrum emission mask
 - measurement, 746, 979
 - See also SEM
- spectrum graph
 - display
 - reference bandwidth markers, 228
- Spectrum key
 - View/Trace key, 73
- spectrum measurement
 - basic mode, 182
 - method, 499
 - results, 126, 337
- spectrum measurement display, 627, 628, 634, 635
- spectrum normal/invert
 - QPSK EVM, 857
- spectrum phase
 - CDPower, 836
- spectrum segment, 325
 - offset segment, 316, 324
 - region segment, 316, 324
 - spectrum emission mask, 1021
- Spectrum Segment key
 - Meas setup key, 147
 - Offset or Region selection, 147
- spectrum type
 - RHO, 968
- spurious emission
 - spectrum segment
 - regions & limits, 319
- spurious emissions and ACP
 - measurement, 979
- standard deviation of trace data, 580, 590
- start measurement, 648, 649
- state
 - changing, 758
- store reference
 - power statistic CCDF, 611
- sweep time
 - SPECTrum, 1038
 - WAVEform, 1048
- Sweep Time key, 358
- Sweep Type key
 - FFT, Swp, or Fast selection, 74
- symbol boundary
 - automatic code channel
 - selection, 236, 292
 - automatic mode, 263
 - Custom mode, 238, 263, 292
 - predefined test models, 236, 263
- Symbol EVM
 - Code Domain, 91
 - Code Domain measurement, 464
- Symbol evm compensation
 - code mod accuracy
 - measurement, 242
 - symbol power graph window
 - amplitude Y scale, 252
 - reference value, 252
 - scale per division, 252
 - reference position, 252
 - reference value, 252
 - scale coupling, 252
 - span X scale, 252
 - scale per division, 252
 - symbol power window
 - display
 - composite chip power, 250
 - symbol rate
 - CDPower, 844
 - RHO, 975
 - sync channel type
 - antenna-1 TSTD SCH, 235
 - antenna-2 CPICH, 235
 - antenna-2 TSTD SCH, 235
 - code symbol based (for BTS), 235
 - CPICH channel (for BTS), 235
 - DPCCH channel (for MS), 235
 - PRACH message (for MS), 235
 - SCH channel (for BTS), 235
 - sync type
 - CDPower, 839
 - modulation accuracy (rho), 970
- T**
- tDPCH chip offset value selection, 239
- test limit
 - OBW, 604, 606
- test limits, 658
- time averaging, 331, 361
- time domain measurement, 755, 1040
- time domain measurements, 358, 500
- time reference
 - burst center, 300
 - burst rise, 300
 - trigger, 300
- timebase frequency accuracy
 - measurement, 754
- timing estimation
 - code domain measurement, 241, 266
- trace averaging, 881
- trace data
 - processing, 580, 590
- trace display, 629
- trace format, 646
- trace names for markers, 598
- trace/view selection
 - magnitude & phase graph view, 157, 372
- transmit band spurs - averaging
 - state, 786, 787, 902, 903, 1043
- transmitted bit rate
 - chip rate, 396
 - spread data rate, 396
- trigger
 - auto time, 1051
 - auto trigger, 201
 - automatic trigger, 202
 - burst level, 1056
 - commands, 1050
 - delay, 202, 1051
 - pre-trigger, 202
 - delay, IF, 1054
 - external, 1051, 1052
 - external front, 202
 - external rear, 202
 - frame adjustment, 1052
 - frame period, 1053
 - frame timer, 201, 202
 - offset, 202
 - period, 202
 - reset offset display, 202
 - synchronizing source, 202
 - holdoff, 1054
 - level, 202, 1052
 - level, IF, 1055
 - on/off, 1050
 - power vs. time, 922
 - RF burst, 202
 - slope, 202, 1052
 - slope, IF, 1055
 - SPECTrum, 1039
 - timeout, 1051
 - trigger holdoff, 201, 202
 - trigger source, 331, 361
 - external front input, 331, 361
 - external rear input, 331, 361
 - frame clock, 331, 362
 - free run (immediate), 331, 361
 - line, 331, 362
 - RF burst (wideband), 331, 361
 - video (IF envelope), 331, 361
 - video (envelope), 202
 - WAVEform, 1049
- trigger measurement, 648, 649
- trigger source
 - cdma2000, 845
 - OBW, 881
 - QPSK EVM, 858
 - Rho, 842
 - spectrum emission mask, 1022
 - W-CDMA, 845

Index

- triggering
 - CHPower, 851
- triggering setup help, waveform measurement, 167
- Two-tone or Transmit IM mode
 - Intermodulation measurement, 94
- Tx Diversity, Code Domain measurement, 239
- U**
- Uninstall Now, 63, 64
- uninstalling measurement personalities, 56
- Upper key
 - Ref Chan key, 105
- V**
- variable data rates, 396
- view ACP data, 620
- view commands, 620
- view PVT data, 625
- view/trace
 - all offsets, 324
 - all regions, 324
 - code domain power graph & metrics, 192, 245
 - code domain quad view, 248
 - demodulated bits, 249
 - I/Q error quad view, 247
 - I/Q waveforms, 134, 348
 - linear spectrum and phase graphs, 132, 345
 - offset A, 324
 - offset E, 324
 - offset side, 324
 - region A, 324
 - region E, 324
 - spectrum graph, 130, 337
- View/Trace key
 - ACPR (ACLR) measurement, 73
 - Code Domain (Quad View) key, 83, 89, 91
 - Code Domain key, 83, 84, 85, 89, 90, 91
 - Demod Bits key, 85, 90
 - I/Q Error (Quad View) key, 84, 102, 124
 - I/Q Measured Polar Constln key, 101, 123
 - Mod Accuracy (Composite EVM) key, 101
 - QPSK EVM key, 123
 - Spectrum key, 73
- view/trace selection
 - all regions, 304
- I and Q Waveform view, 160, 375
- I and Q waveform view, 356
- I/Q polar waveform view, 162, 377
- I/Q waveform graph window, 130, 345
- I/Q Waveform view, 158, 373
- linear envelope and phase view, 154, 369
- region A only, 305
- region E only, 305
- rising and falling edge regions, 305
- Spectrum I/Q Waveform view, 130, 345
- spectrum linear
 - linear spectrum window, 354, 355
- viewing the time domain, 167
- VSA versus PSA series (programming compatibility), 560
- W**
- WAVEform
 - acquisition packing, 1040
 - ADC filter, 1041
 - ADC range, 1042
 - data decimation, 1047, 1048
 - sweep time, 1048
 - trigger source, 1049
- waveform
 - changing displays, 379
 - I and Q waveform view, 382
 - I/Q waveform view, 382
 - linear envelope view, 381
 - method, 500
 - resolution bandwidth, 358
 - results, 150
 - span X scale, 379
 - sweep time, 379
 - using markers, 259, 383
- Waveform (Time Domain) key, 500
- Waveform (Time Domain) Key Menus, 358
- waveform (time domain)
 - measurement, 755, 1040
 - See also WAVEform
- waveform measurement, 167, 358
 - basic mode, 182
 - display, 383
 - I/Q Polar view, 380, 382
 - results, 150
- WB ADC Dither key, 328, 359
- W-CDMA
 - 3rd generation RF cellular, 396
 - ACP measurement, 764
 - trigger source, 842
 - wideband code division multiple access, 396
 - W-CDMA (3GPP)
 - averaging, 855
 - offset frequencies, 987, 1005, 1006, 1020
 - offset frequencies auto mode, 988, 989, 1007
 - spectrum emission mask measurement, 996, 998, 1000, 1002, 1003, 1004, 1013, 1014, 1016, 1017, 1018, 1019
 - trigger source, 858, 1022
 - W-CDMA (3GPP) key
 - MODE key, 77
 - Mode Setup key, 77
 - W-CDMA (3GPP) measurement, 658, 667, 703, 706, 709, 711, 713, 718, 724, 746, 853, 865, 872, 878, 908, 979
 - W-CDMA (Trial & ARIB)
 - averaging, 855
 - trigger source, 858
 - W-CDMA (Trial & ARIB) measurement, 658, 667, 703, 713, 718, 724, 853, 908
 - W-CDMA measurement, 758
 - well balanced multiple carriers, 482
 - Wideband Advanced key, 327, 359
 - wideband code division multiple access
 - W-CDMA, 396
 - wideband filter alpha, 327, 359
 - wideband filter bandwidth, 327, 359
 - wideband filter type, 359
 - Wideband Filtering key, 327, 359
 - wideband IF
 - advanced settings, 328, 359
 - wideband IF data block size, 359
 - wideband IF data sample rate, 359
 - wideband IF filter type, 327
 - Wideband IF Gain key, 327, 358
 - Wideband IF Setup key, 327, 358
 - wideband path selection, 332, 362
 - window focus move control, 636
 - Window Length key, 329, 333
- X**
- x-axis couple control, 637

x-axis reference level, [639](#)
x-axis reference position, [640](#)
x-axis scale/div, [638](#)

Y

y-axis couple control, [640](#)
y-axis reference level, [642](#)
y-axis reference position, [643](#)
y-axis scale/div, [641](#)
You, [260](#)

Z

zero span measurement, [755](#),
[1040](#)
zoom the display, [622](#)

Index
